

Industrial/Commercial Facility Strategy

DRAFT: June 2023

BACKGROUND

Consistent with Schedule A.3.g of the City of Wilsonville’s (City) Phase I National Pollutant Discharge Elimination System (NPDES) Municipal Separate Storm Sewer System (MS4) permit, the City must continue to implement a program to reduce the discharge of pollutants from industrial and commercial facilities’ stormwater discharges into the MS4. The City has implemented an Industrial/Commercial Facility Inspection Program since 2013, as referenced in their approved 2022 Stormwater Management Program (SWMP) Document. This Industrial/Commercial Facility Strategy document represents an update to that Inspection Program document.

The purpose of this document is to fulfill requirements of Schedule A.3.g.i and A.3.g.ii of the City’s NPDES MS4 permit, effective May 5, 2023. This document describes the steps the City will follow to implement a program to reduce pollutants in stormwater discharges to the MS4 from industrial and commercial facilities.

Per Schedule A.3.g.ii, the Industrial and Commercial Facility Strategy Document must include, at a minimum:

- A. *The facility types or activities, rationale, and priorities for entities that the co-permittee has determined may have high potential to discharge pollutants of concern to the MS4,*
- B. *Inspection procedures, documentation standards, and frequency of inspections; and*
- C. *Description of the assessment and tracking of compliance with municipal ordinances related to discharges to the MS4 at industrial and commercial facilities that are potential sources of pollutants in stormwater runoff.*

GENERAL INFORMATION

The City of Wilsonville maintains an inventory and database of all registered businesses that have obtained a business license with the City. While many of those businesses are related to professional services and work-at-home activities, the City still has a significant number of commercial and industrial businesses that could be included in this program. The database stores information provided on business license applications, including the business’s name, address, business owner and contact information, federal identification number (EIN), and six-digit North American Industry Classification System (NAICS) code. The business license application also asks applicants to indicate whether they classify as an industrial or commercial facility with potential to discharge stormwater runoff.

As of May 2023, 12 facilities within Wilsonville have active industrial stormwater NPDES 1200-Z permits. A list of the existing permits and permit applications is included as Table 1, included at the end of this SOP. The permit database is maintained by Oregon DEQ and is searchable online. All existing 1200-Z permits were reissued in 2021 and maintain a 2026 expiration date.

FACILITY SCREENING

The City's Environmental Specialist maintains a working list of businesses or facilities that may be considered high potential pollutant generating facilities (i.e., industrial and commercial). This High Potential Pollutant Generating Facility List (List) was initially developed in 2013 to reflect businesses with 2000 or 3000 series SIC codes (associated with manufacturing activities), results of past pretreatment inspections, and existing 1200-Z permit holders. The List has been updated since 2013 and new businesses have been added. Inspections conducted since 2013 have resulted in the categorization of businesses as having low, medium, or high potential for pollutant discharge to the MS4. This information has been retained to inform ongoing inspection efforts (i.e., historic concern priority).

Annual desktop screening will continue to be conducted for new business licenses issued over the previous reporting year. The annual desktop screening will: 1) help identify businesses that may be subject to industrial stormwater NPDES 1200-Z permit requirements; 2) identify businesses that have the potential to contribute significant pollutant loads to the MS4; and 3) determine whether those businesses should be included in the City's Industrial/Commercial Facility Inspection Program. Criteria used to inform the desktop screening process include:

1. Site Location in Wilsonville
2. Businesses with description that indicates potential for the following site activities:
 - a. Materials handling/storage
 - b. Excavation and grading
 - c. Pesticide application
 - d. Equipment washing
 - e. Scrap metal storage
 - f. Equipment storage
 - g. Vehicle repair
 - h. Fueling or Fuel transfer
3. New or potential 1200-Z permittees (Note: SIC Codes requiring 1200-Z permit coverage are in Table 1 of the 1200-Z permit)
4. Business licenses that include an unknown NAICS code (00001)

INDUSTRIAL STORMWATER NPDES PERMIT IDENTIFICATION AND NOTIFICATION

Annually, in conjunction with the desktop screening effort, the City's Environmental Specialist reviews new business licenses to identify any businesses that could be regulated and subject to an industrial stormwater NPDES permit. New or potential 1200-Z permit needs are informed

by the NAICS code designation and applicant response to the business license question related to potential for discharge to the City's public storm sewer system or surface water body.

The City has a database tool to convert NAICS codes to equivalent SIC codes. The NAICS/SIC code is reviewed in conjunction with DEQ's guidance document "*Screening Industrial Facilities to Assess Potential for Industrial Stormwater NPDES Permit Applicability*" (dated June 2013) to identify potential facilities needing permits. DEQ's guidance document "*Industrial Stormwater Best Management Practices Manual*" (dated February 2013) is included as Attachment 2.

In cases where the Environmental Specialist identifies that a new business or facility may be subject to an industrial stormwater permit, the facility is automatically flagged for a windshield survey and a formal onsite inspection to confirm whether the facility meets the conditions of DEQ's guidance document.

The City is not currently a DEQ agent for the industrial stormwater NPDES program. It is ultimately the responsibility of DEQ and the facility owner/operator to determine whether an industrial stormwater NPDES permit is required for a given facility.

FACILITY INSPECTIONS

The City's Stormwater Management Plan (2022) requires annual inspections of industrial/commercial facilities that are identified as priority facilities warranting inspection. The inspections include windshield surveys and formal onsite inspections. The goal of the facility inspection is to identify water quality impairments and work with facility owners and operators to remove the discharge.

The City's list of high potential pollutant generating facilities includes a wide range of operations and facility types. Some businesses may operate entirely indoors and are not likely to have a significant impact on stormwater quality while other businesses may be of more concern due to their manufacturing processes, the physical structure of the facility, or the proximity of the facility to surface water. Selection of businesses for an annual windshield survey is based on the following criteria:

1. New businesses per desktop screening criteria.
2. Historic concern priority (medium or high, based on previous inspection results and recorded site activities).
3. Reported/ recorded spill or illicit discharge or public complaint.
4. Presence of a stormwater facility that would allow the inspection to also be used to meet the City's private stormwater facility inspection needs.

Annually, the City's Environmental Specialist will conduct a windshield survey of each facility meeting inspection criteria. The windshield survey is used to update the historic concern priority and maintain the City's database with updated information. During the windshield survey, sites will be initially identified as high, medium, or low potential. Sites with observed housekeeping issues and potential for offsite discharge will be classified as "high" and prioritized for an onsite inspection. The prioritization is based on professional judgment and the understanding of City staff of the current activities and facilities at each site. The prioritization may also consider whether facilities have ongoing inspections as part of other

regulatory programs (e.g., has a current 1200-Z permit) and whether additional information regarding the facility is needed to confirm whether the facility may be subject to a 1200-Z permit.

Formal, onsite inspections will be conducted on up to five high priority businesses annually.

Legal Authority

The City's authority to inspect business premises is outlined in the City of Wilsonville Code (WC) 8.214. The City's authority to prohibit pollutant discharges to the MS4 is covered in WC 8.202 under public sewer use.

Procedures

Windshield and onsite business inspections will be initiated and conducted by the Environmental Specialist. The City will assemble the following materials for use during the inspection:

- Industrial/Commercial Inspection Program, Facility Inspection Form (see Attachment 1)
- Aerial map of the facility
- Camera
- A copy of the guidebook, Industrial Stormwater Best Management Practices Manual (DEQ, February 2013)

During the windshield survey, the Environmental Specialist will observe the site and features readily observed without directly accessing private property. Inspectors may remain in the vehicle or physically walk the site (outdoors) to evaluate whether the facility has the potential to contribute significant pollutant loads to the MS4. Presence of stormwater treatment facilities will be noted.

During both windshield and onsite inspections, the Environmental Specialist will complete the Facility Inspection Form, noting any findings of concern and indicating the appropriate follow-up action(s) and will take pictures of activities or site conditions that look to be problematic.

If a facility is determined to require an onsite inspection, the City will provide advance notice to the business operator in the form of a phone call to schedule an appropriate time to conduct the inspection. Records of phone calls and communications with business owners/operators will be retained in the City's files. Private property access or indoor inspection activities will only occur during onsite inspections when the owner has been notified. At the conclusion of the inspection, the Environmental Specialist will verbally discuss any findings of concern with the business owner/operator.

Follow-up Actions

Any observed illicit discharges will be recorded by the City for inclusion and reporting in their NPDES MS4 annual report and appropriate follow-up procedures will be initiated.

For businesses that are found to not contribute significant pollutant loads to the MS4, the High Potential Pollutant Generating Facility List will be updated with observations and the Historic Concern Priority will be set at Low. The Facility Inspection Form will be completed, and inspection date noted. No additional follow-up actions are required. If an onsite inspection was conducted, the Environmental Specialist will prepare a follow-up letter, thanking the business for participating in the City's Industrial/Commercial Facility Inspection Program.

For businesses that appear to require coverage under a general NPDES industrial stormwater permit (1200-Z permit), City staff will prepare a notification letter. If the business may be subject to a 1200-Z permit, the notification letter will be sent to both the business license applicant and DEQ's NW Region Office within 30 days.

If the business is potentially contributing pollutants to the MS4 (but the business does not appear to be subject to a 1200-Z permit), and resolution to issues observed could not be immediately resolved during the onsite inspection, the Environmental Specialist will prepare a follow-up letter, outlining observed concerns and refer the business to DEQ's Industrial Stormwater Best Management Practices Manual (DEQ, February 2013). The letter will indicate a potential violation of WC 8.202 and indicate that a follow-up inspection may be conducted to identify whether the pollutant discharge has been corrected or is an ongoing problem.

Additional follow-up inspections may be conducted, utilizing the same Facility Inspection Form that was completed for the initial inspection. Observations and findings will be recorded, and a follow-up action will be identified. Ongoing pollutant source problems will be referred to the City's illicit discharge program for follow-up and enforcement.

Copies of all letters are retained in the City's files.

PROGRAM TRACKING AND RECORDKEEPING

The City will maintain records of Industrial/Commercial Inspection activities and follow-up actions to meet annual reporting requirements of the MS4 Permit.

ATTACHMENTS

The following documents are included with this SOP:

- Attachment 1: Business Inspection Stormwater Checklist
- Attachment 2: DEQ Guidance Document "*Industrial Stormwater Best Management Practices Manual*" (Dated February 2013).

Table 1. 1200-Z Permittees (as of May 2023)

Permit Number	SIC	Legal Name	Common Name	Location	Receiving Water	Issuance Date	Expiration	Historic Priority Level	Onsite Stormwater Facilities (Y/N)
24214	2893	XEROX CORPORATION	XEROX	27063 SW CANYON CREEK RD	Willamette River	2008	2026	Low	Y
12783	3272	OLDCASTLE PRECAST, INC.	OLDCASTLE PRECAST UTILITY VAULT	28499 SW Boberg Rd	Willamette River (via Coffee Creek)	2001	2026	High	Y
14095	4213	MARTEN TRANSPORT, LTD.	MARTEN TRANSPORT, LTD.	29605 SW KINSMAN RD	Willamette River (via Coffee Creek)	1998	2026	Low	N
14568	5093	WILLAMETTE RESOURCES, INC.	WRI MATERIAL RECOVERY FACILITY	10295 SW RIDDER RD	Willamette River	1997	2026	Medium	Y
16963	2056	Swire Pacific Holdings, Inc.	Swire Coca-Cola USA	9750 SW BARBER ST	Willamette River (via Coffee Creek)	2001	2026	Low	Y
24158	4111	TRI-COUNTY METROPOLITAN TRANSPORTATION DISTRICT OF OREGON	TriMet WES COMMUTER RAIL MAINTENANCE FACILITY	9499 SW BARBER ST	Willamette River	2008	2026	Low	Y
28937	4212	Pacific Foods of Oregon, LLC	Pacific Foods	27255 SW 95TH AVE	Willamette River	2012	2026	Low	N
33090	1541	Sysco Portland, Inc.	Sysco of Portland	26250 SW PARKWAY CENTER DRIVE	Willamette River	2019	2026	Medium	Y
33963		Delta Logistics, Inc.	Delta Logistics	9835 SW COMMERCE CIRCLE	Willamette River	2021	2026	Low	N
13181	3291	FUJIMI CORPORATION	FUJIMI CORPORATION - SW COMMERCE CIRCLE	9949 SW COMMERCE CIRCLE	Willamette River	1998	2026	Low	N
27600	4225	THRIFTY PAYLESS, INC	RITE AID DISTRIBUTION CENTER # 0080	29555 SW BOONES FERRY RD	Willamette River (via Coffee Creek)	2011	2026	Low	Y
33964	209	AB Mauri Food Inc.	AB Mauri	26994 SW 95TH AVENUE	Willamette River (via Coffee Creek)	2021	2026	Low	N

ATTACHMENT 1: BUSINESS INSPECTION STORMWATER CHECKLIST

Wilsonville

INDUSTRIAL/COMMERCIAL INSPECTION PROGRAM

FACILITY INSPECTION FORM

Windshield and onsite inspections must be conducted by a person with the knowledge and skills to assess conditions and activities that could impact stormwater quality and evaluate the effectiveness of best management practices. Retain a copy of the completed form.

I. INSPECTION SUMMARY (WINDSHIELD AND ONSITE)	
FACILITY NAME:	INSPECTION DATE: TIME:
FACILITY ADDRESS:	INSPECTOR(S) NAME:
BUSINESS TYPE:	WEATHER INFORMATION:
CONTACT INFORMATION:	PERSONS PRESENT DURING INSPECTION:
II. FACILITY OVERVIEW (WINDSHIELD AND ONSITE)	
DESCRIBE SITE CONDITIONS AND ACTIVITIES:	
STORMWATER SYSTEM COMPONENTS: (catch basins, trench drains, floor drains, roof drains, ditches, drywells, treatment facilities, etc.)	

POINT OF DISCHARGE/ POTENTIAL FOR OFFSITE POLLUTANT DISCHARGE¹:

III. POTENTIAL POLLUTANT SOURCE AREA INSPECTION AND BMP EVALUATION (WINDSHIELD AND ONSITE)

Good Housekeeping BMPs:	Y	N	N/A	Findings and Follow Up Actions:
<ul style="list-style-type: none"> • Are paved surfaces free of accumulated sediment and debris? • Waste receptacles located outdoors covered and appear in good condition? • External surfaces and areas free of excessive contaminant buildup? • Methods in place to prevent erosion and sediment discharge to storm drains? 				
Spill Response and Equipment:	Y	N	N/A	Findings and Follow Up Actions:
<ul style="list-style-type: none"> • Spill kits available and properly stocked? • Any evidence of leaks or spills? • Any vehicles and/or equipment leaking fluids? 				
Vehicle/Equipment Areas:	Y	N	N/A	Findings and Follow Up Actions:
<ul style="list-style-type: none"> • Is equipment washed and/or cleaned in ways that are protective of stormwater? • Fueling areas free of contaminant buildup and evidence of chronic leaks/spills? • Tools, equipment and materials stored in designated areas? • Drums and containers of fluids stored with proper cover and containment? 				

¹ If there are observed outdoor activities (material storage/stockpiling, fueling, washing, manufacturing) that may result in the potential for the discharge of pollutants to the public stormwater system, proceed to Section III and designate as medium or high priority.

Material Storage Areas: <ul style="list-style-type: none"> • Potential pollutants stored inside a building or another type of storm resistance shelter? • Material piles secured to protect storm drainage system? • Are outdoor containers covered? • Are empty containers cleaned and stored properly? 	Y	N	N/A	Findings and Follow Up Actions:
Stormwater BMPs and Treatment Structures: <i>Visually inspect all stormwater infrastructure and treatment BMPs. Complete private facility inspection forms where applicable.</i>	Y	N	N/A	Findings and Follow Up Actions:
Observation of Non-Stormwater Discharges: <i>Visually inspect the site for illicit discharges and/or evidence of dumping or washing into the storm drainage system.</i>	Y	N	N/A	Findings and Follow Up Actions:
Additional Findings and Priority Rating: <i>Describe additional inspection findings, priority rating and follow-up actions, if needed.</i>				
IV. FOLLOW-UP ACTION (check all that apply):				
<input type="checkbox"/> Onsite Inspection Needed, based on observed conditions (if form initially filled out to support windshield survey and designated as high priority) <input type="checkbox"/> Daily operations of the site are not a concern for significant pollutant discharge to the MS4; Historic Concern Priority = Low; Close File <input type="checkbox"/> Site activities/conditions are a concern for pollutant discharge to the MS4; Prepare letter and schedule onsite inspection <input type="checkbox"/> Observed illicit discharge; Refer for enforcement <input type="checkbox"/> Other: _____				

FOLLOW-UP (ONSITE) INSPECTION (IF NEEDED)	
INSPECTION DATE: TIME:	INSPECTOR(S) NAME:
WEATHER INFORMATION:	PERSONS PRESENT DURING INSPECTION:
OBSERVATIONS/FINDINGS:	FOLLOW-UP ACTION: <input type="checkbox"/> Problem Resolved; Close File <input type="checkbox"/> Problem Persists; Refer for Enforcement <input type="checkbox"/> Other: _____

ATTACHMENT 2: DEQ GUIDANCE DOCUMENT “*INDUSTRIAL STORMWATER BEST MANAGEMENT PRACTICES MANUAL*” (DATED FEBRUARY 2013).

Industrial Stormwater Best Management Practices Manual

By: Dennis Jurries, PE
Krista Ratliff

February 2013



State of Oregon
Department of
Environmental
Quality

**Water Quality Division
Surface Water Section**

811 SW 6th Avenue
Portland, OR 97204
Phone: (503) 229-5696
(800) 452-4011
Fax: (503) 229-6762
Contact: Erich
Brandstetter
www.oregon.gov/DEQ

DEQ is a leader in restoring, maintaining and enhancing the quality of Oregon's air, land and water.



This report prepared by:

Oregon Department of Environmental Quality
811 SW 6th Avenue
Portland, OR 97204
1-800-452-4011
www.oregon.gov/deq

Contact:
Dennis Jurries
(503) 229-5937

Alternative formats (Braille, large type) of this document can be made available.
Contact DEQ's Office of Communications & Outreach, Portland, at (503) 229-5696, or toll-free in Oregon at 1-800-452-4011, ext. 5696.

Table of Contents

Executive Summary	1
Introduction.....	2
Best Management Practices	4
BMP 1 Coolant/Oil Recovery.....	4
BMP 2 Weld Fume Control	6
BMP 3 Drum & Container Containment	7
BMP 4 Tank Containment	9
BMP 5 Metal Roof & Siding Coating, Gutter and Downspout Treatment.....	10
BMP 6 Biological Based Parts Cleaners.....	11
BMP 7 Lined Grease Containers	12
BMP 8 Vehicle, Pavement, and Building Washing.....	13
BMP 9 Oil/Water Separators	15
BMP 10 Oil/Water Separators for Air Compressors	17
BMP 11 Oil & Sediment Trap Catch Basins	17
BMP 12 Containers for Dust Collectors	19
BMP 13 Ozone Generators for Cooling Towers.....	20
BMP 14 Cartridge Filtration	21
BMP 15 Sweeping	23
BMP 16 Battery Storage	24
BMP 17 Wrecked Vehicle Storage & Scrap Metal Recycling	25
BMP 18 Paint Stripping.....	27
BMP 19 Equipment Covers	28
BMP 20 Brake Shoe Replacement.....	29
BMP 21 Employee Environmental Training	30
BMP 22 Housekeeping	31
BMP 23 Lawn Care	33
BMP 24 Dumpster Covering	36
BMP 25 Semi-Trucks and Trailers	38
BMP 26 Fueling and Liquid Loading/Unloading Operations.....	39
BMP 27 Parking Lots and Yards	40
BMP 28 Stormwater Diversion - Speed Bumps and Speed Humps	41
BMP 29 Grassy Filter Strip and Planter	42

Industrial Stormwater Best Management Practices

BMP 30 Catch Basin Insert Bag	44
BMP 31 Constructed Wetlands.....	45
BMP 32 Bioswales.....	47
BMP 33 Sand Filters	49
BMP 34 Porous Pavers	50
BMP 35 Flocculation	50
BMP 36 Electrocoagulation.....	54
References.....	57

Executive Summary

This document is designed to aid in the selection and implementation of best management practices for the protection of water quality affected by industrial stormwater discharges.

Best management practices, or source controls, are practices and/or procedures to prevent pollution in stormwater discharge, including methods to prevent toxic and hazardous substances from reaching receiving waters. They are designed to address the quality of a facility's practices and may ultimately affect the ability of the facility to meet effluent limits, impairment and sector-specific reference concentrations and/or benchmarks. Best management practices are most effective when organized into a comprehensive stormwater pollution control plan. Several different source controls can be used to achieve similar environmentally protective results. With facility-specific or activity-specific pollutant(s) of concern as the major consideration(s) in selecting appropriate best management practices, facilities can tailor a stormwater pollution control plan to achieve permit compliance with available technologies.

The best management practices included in this document address activities and operations that take place outdoors and do not address pollutants from indoor industrial production. These practices are to be considered a work in process and are by no means a complete list of appropriate pollution control measures. DEQ may periodically add other best management practices to this document.

Introduction

Background:

Under the Total Daily Maximum Load, or TMDL, program states must list waterbodies not meeting water quality standards and to determine, for each degraded waterbody, the “total maximum daily load” of the problematic pollutant that can be allowed without violating the applicable water quality standard. The regulating community or agency then determines what types of additional pollutant loading reductions are needed, considering not only point sources but also nonpoint sources. The regulator then establishes controls on these sources to ensure further reductions to achieve applicable water quality goals. National Pollutant Discharge Elimination permit conditions must respond to federal U.S. Environmental Protection Agency stormwater requirements, as well as TMDLs, which have been mandated by Congress to regulate stormwater discharges more rigorously. Locally in 2007 and 2008, two environmental advocacy groups, Northwest Environmental Defense Center and Columbia Riverkeeper, challenged the validity of the Oregon’s current industrial permits under the federal Clean Water Act. DEQ revised the industrial NPDES permit as part of a settlement agreement and implemented significant changes.

Organization:

This is a ‘living document’ with new additions generally added at the document’s end. Table 1, following the Reference section, is organized by type of activity and provides an index to the numbered best management practices for easy access to the body of information.

Best Usage:

The best way to use this guide is to assess your site’s *activities* that affect your stormwater discharge(s), using Table 1. Determine the pollutants in the stormwater discharge(s) and the potential sources of those pollutants on site, then determine which potential sources have the most significant impact on the discharge(s). Select a best management practice or practices that will be most effective in controlling pollution in the stormwater discharges, while being practical about resources and costs that will be required to implement and maintain those practices. After you install selected best management practices, sample the stormwater discharges to verify reduced pollutants and determine if additional practices will be necessary to meet permit monitoring requirements for the various pollutants of concern. [Caution: The efficiencies provided in this document should be used as indicators of the potential pollutant reduction related to best management practice installation. The efficiencies can be variable depending on a number of factors including flow, maintenance of the best management practice, loading and other factors.]

Low Impact Development began in Prince George’s County, Maryland in 1990 as an alternative approach to the no longer cost-effective detention ponds and basin on construction sites. The concept has become the preferred method of stormwater management because engineered small-scale hydrologic controls replicate pre-developed conditions through infiltration, filtration, storage, evaporating and detaining water close to its original source. Often space is a limiting factor for industrial facilities’ use of low-impact development controls. Other limitations include: soil conditions, climate, groundwater levels, cost and maintenance. DEQ promotes the use of low-impact development practices to reduce stormwater flows and control the mass load of pollutants that enter the receiving stream. In addition, if an industrial facility can capture and treat and/or infiltrate all stormwater without discharging to waters of the state or a conveyance system that discharges to waters of the state, that facility may be eligible for termination of NPDES permit coverage. Low-impact development options include:

- Bioretention Areas
- Dispersion or Swales
- Vegetated Roofs
- Permeable Pavements or Pavers
- Roof Rainwater Collection Systems (for re-use)

Underground Injection Control places fluids below the ground through dry wells, drill holes, soaking

Oregon Department of Environmental Quality

Industrial Stormwater Best Management Practices

trenches and infiltration facilities with under drains. Any infiltration facility is a UIC if it is deeper than the facility is wide. Oregon Association of Clean Water Agencies hired Kennedy/Jenks Consultants to evaluate stormwater data before entering UIC devices. This report use data from five municipalities around Oregon, Clackamas County, Gresham, Redmond, Bend and Portland to provide DEQ with groundwater protectiveness models to demonstrate UICs do not pose a likely adverse risk to groundwater. This report and other factors reaffirm that injection systems to dispose of water that may come in contact with any raw material, product, byproduct or waste during manufacturing or processing may be a viable option while protecting groundwater under the Safe Drinking Water Act federally enacted in 1974. If all stormwater can be injected into the ground, permitting will be addressed through the underground injection control program and the facility may be exempt from NPDES permitting. All underground injection controls must be registered and approved for issuance through either a water pollution control facility (WPCF) permit or authorized by rule. Stormwater may be managed through underground injection systems provided conditions established in rule can be met. Some industrial activities which may inhibit use of groundwater injection include:

- Vehicle washing, maintenance, repair and recovery
- Airport de-icing
- Storage of treated lumber
- Facilities handling hazardous materials or improper storage and containment of chemicals
- Sites under Resource Conservation and Recovery Act (RCRA)

Best Management Practices

BMP 1 Coolant/Oil Recovery

Activity: Mechanical metal removal through the use of high-speed equipment and the associated discharge of metal fines in the form of swarf, grindings, chips, etc.



Typical Pollutants: Heavy metals, i.e. chromium, copper, manganese, lead, zinc; Dissolved Oxygen consuming organisms, i.e. bacteria, fungi; Chemicals in the coolant, i.e. corrosion inhibitors, emulsifiers, biocides, and etc.; Tramp oil; and Decreased pH.

Typical Problem: Swarf and turnings are discharged into a hopper along with varying amounts of coolant and tramp oil. The hopper is transported outside and dumped into a dumpster or special portable scrap bin supplied by a scrap dealer. Typically the outside bin or dumpster is not liquid proof nor is it covered. The coolants, metal fines, and tramp oil leak out of the outside bin or are spilled in the process of loading onto a transport vehicle. Quite often the discharge continues as the truck carries the scrap down the highway.

BMP: Locating the outside scrap bin on a concrete pad that drains into a dead-end containment sump and is bermed to prevent storm water run-on may resolve the potential source providing that the sump is emptied periodically. The sump should either be double contained or be coated on the inside with a flexible epoxy to minimize any seepage from any small cracks that may develop in the concrete sump. The trapped oil in the sump can be removed with a Belt Skipper similar to that shown on the right.



Industrial Stormwater Best Management Practices

Another approach that works is to modify the scrap hopper located at the metal removing machinery for coolant/oil separation from the swarf while the coolant/oil is warm and less viscous. This approach would minimize or eliminate leakage outdoors by removing most of the potential contaminants at the source.

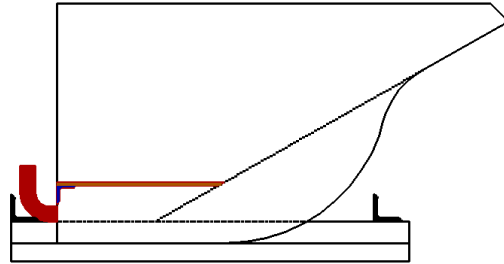

A removable plate, either solid or with small perforations, either screened or unscreened, can be added to the bottom of the swarf/chip hopper. This creates a sump for the coolant and oils to drain into while the liquid is very hot and thus less viscous. A piping connection should be made into the lower chamber sized to fit the hose end on your sump sucker. If holes are made in the bottom plate, the number of holes will be determined with experimentation. They should be sufficient to provide the air draw of the sump sucker and should be located to encourage the best flow out of the lower chamber when the liquid is sucked out.



The same thing can be done with large scrap dumpsters. A Vacuum Truck would be needed to suck out all of the fluids from the large sump pipe.

Coolant should be of the synthetic type and should be recycled on site. Small package recycling units are available from several manufacturers.



A few manufacturers will modify existing hoppers or sell new hoppers that have a filtering

Industrial Stormwater Best Management Practices

screen and filter material separating the scrap from the liquid chamber.



Two commercially available bins with built in screening.

As the scrap bins are moved outside, pause at the outside door where someone should use a sump sucker to draw the liquid/fines out of the lower chamber for either proper disposal or recycling of the coolant.

Efficiency/Impact: Virtually all liquid and metal fines from this activity are prevented from entering the storm water drainage by implementation of this BMP provided the outside scrap dumpster/bin is covered when scrap from inside bins are not being discharged in to it. This point source should no longer be a significant contributor of pollutants to the storm water discharge.

BMP 2 Weld Fume Control

Activity: Metal cutting with gas burners, oxygen/acetylene torches, and welding of metal with stick, wire, or gas welders.

Typical Pollutants: Oily air emissions, metal particles; gaseous metal; and vaporized flux.

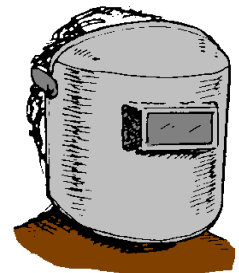

Typical Problem: The fume from the metal cutting/welding operation is exhausted to the outside where it comes in contact with rain and precipitates out into the storm water. Indoor air quality is also of concern.

BMP: Welding creates an oily soot type smoke. The amount of smoke produced from the welding process can be estimated using the table below.

Fume Ratio:

MIG (Wire Feed)	0.005-0.01	lb. of smoke/lb. of rod
TIG	0.004	lb. of smoke/lb. of rod
Oxy-acetylene torch	0.004	lb. of smoke/lb. of rod
Stick	0.015	lb. of smoke/lb. of rod
Flux core	0.02	lb. of smoke/lb. of rod

This fume has products that can be very small, submicron in size.

Industrial Stormwater Best Management Practices



There are several methods to control this fume. Centralized cartridge filtration systems like that shown on the left and portable HEPA filtration systems similar to that shown on the right are a couple of control methods in use today which appear to be phasing out electrostatic precipitator systems. Air extraction units with mist or charcoal filters can also be used.

Efficiency/Impact: Implementation of one of these BMPs will mostly eliminate this source of pollutants, not only to storm water but also to air, and significantly improve indoor air quality. As an added benefit, if the air inside of a building is heated, it may be possible to recycle the air and provide a significant energy cost savings in the winter months. This point source should no longer be a significant contributor to the storm water discharge concerns.

BMP 3 Drum & Container Containment

Activity: Oil (& other fluids) dispensing and outside storage

Typical Pollutants: Oil, hydraulic fluid, antifreeze, paint, solvent, cleaners, petroleum hydrocarbons, toluene, ethylene glycol, etc.



Typical Problem: Drums, pails, and small containers of liquids are stored outside in non-bermed, un-contained areas, which through expansion and contraction of the container, can damage the container, or the container bungs causing leaks, or filling/dispensing op-

Industrial Stormwater Best Management Practices

erations can discharge pollutants to the ground in the vicinity. Rain and snow contact this material and transport it off site or into the ground water.

Dispensing oil, antifreeze, and other potentially hazardous liquids may result in spills and leaks around the dispensing area. This leaked liquid can be tracked to other locations, or can seep through cracks and floor joints into the soil and groundwater beneath the floor. Rain and snow melt may transport these pollutants off site.

BMP: Portable metal storage buildings with built-in containment reduces this risk and better protects the liquid containers from damage and possible contamination. Environmental controls, i.e. heating and air conditioning, and fire protection are usually available in these pre-constructed units if needed.



If drums must be kept outside consider using cone shaped drum covers to keep water off the top of the drums

Industrial Stormwater Best Management Practices



Containment pallets made from steel or plastic will contain the liquid

When dispensing into secondary containers, the containment should drain into a drum or other container. Hoses on dispensing stations should not be able to extend beyond the containment area. For dispensing area containment, the volume of the containment area should be equal to the tank being dispensed from. If possible dispensing areas should be under roof or some other protection from stormwater. If a roof is not provided to keep out rain and snow, then the volume of the enclosure should be 110% of the volume of the largest bulk tank inside of the enclosure

Efficiency/Impact: Implementation of these BMPs will reduce the risk of exposure to stormwater of the contaminants associated with the delivery, dispensing, and storage of the materials in bulk tanks. Some risk of contamination will still exist from the material handling activities associated with moving containers of these liquids to and from the pallets or storage buildings or dispensing.

BMP 4 Tank Containment

Activity: Storage of liquids in bulk containers or tanks.



Typical Pollutants: Oils, diesel, gasoline (petroleum hydrocarbons); antifreeze (ethylene glycol); and solvents (toluene, mineral oil)

Typical Problem: Leakage or spillage occurs around tanks from filling, dispensing, deterioration of pipe connections or failure of secondary containment

Industrial Stormwater Best Management Practices

BMP: Bulk storage tanks should have secondary containment in the form of a curbed enclosure with a liner to prevent migration of the liquids through the enclosure walls and floor. The liner can be in the form of a compatible flexible epoxy or a liner membrane compatible with the fluids being contained. If a roof is not provided to keep out rain and snow, then the volume of the enclosure should be 110% of the volume of the largest bulk tank inside of the enclosure. Fill locations should have drip trays that drain into a drum or other container. Dispensing areas should have their own containment. When dispensing into secondary containers, the containment should drain into a drum or other container. Hoses on dispensing stations should not be able to extend beyond the containment area. For dispensing area containment, the volume of the containment area should be equal to the tank being dispensed from. Dispensing areas should be under roof or some other protection from storm water. Caution should be used to ensure that incompatible materials are not contained within the same enclosure.

Double-walled, aboveground storage tanks maybe used instead of single walled storage tanks with containment structures. Filling and dispensing areas associated with double-walled tanks should have containment and protection from storm water.



Efficiency/Impact: Implementation of this BMP will reduce the risk of exposure to storm water of the contaminants associated with the delivery, dispensing, and storage of the materials in bulk tanks.

BMP 5 Metal Roof & Siding Coating, Gutter and Downspout Treatment

Activity: Runoff from buildings with corrugated galvanized sheet metal roofs and/or siding and gutter and downspouts

Typical Pollutants: Zinc & Iron

Typical Problem: As the sheet metal ages zinc from the galvanized coating is released to storm water runoff. If the loose of zinc continues for too long then, iron will also show up in the storm water discharge and eventually the roof or siding will have to be replaced rather than be repaired.



BMP: Avoid using galvanized sheeting on new construction. Clean and paint the exposed galvanized sheet with a good enamel paint. Be sure to contain and collect any liquids used in cleaning for proper disposal. Instigate a regular inspection and maintenance program concerning the building painting.

Industrial Stormwater Best Management Practices



Painted Siding and Roof

Downspout Treatment

Efficiency/Impact: With proper maintenance of the painted surface the zinc and iron in runoff can be decreased from this source to the non-detect level. Periodic recharging of or replacement of the filter media will significantly reduce the zinc and iron levels in the downspout runoff (see page 23 for some of the possible pollutant reductions obtainable).

BMP 6 Biological Based Parts Cleaners

Activity: Cleaning of parts and equipment in parts cleaners containing mineral spirits/oil or petroleum products.

Typical Pollutants: Petroleum hydrocarbons

Typical Problem: The use of petroleum based cleaners leads to the requirement for either storage of the spent cleaner or recycling companies periodically removing old cleaner solution/sludge and adding new solution. This results in spent cleaner storage on site and/or frequent handling of both the clean and contaminated cleaner. This increases the risk of spills and leakage getting into storm water. The spent cleaning solution/sludge must be treated as a hazardous waste and be properly handled and disposed.

BMP: Large parts and frames are generally cleaned in a shot blast machine. Smaller parts should be cleaned in an aqueous based solution (caustic or other) or in a biological solution. These units typically are heated and may involve agitation. Parts cleaners other than these typically have a sludge residue or the solution has to be replaced periodically. The sludge or removed solution is usually considered a hazardous waste somewhere in its cycle. The sludge from an aqueous based or biological parts washer is not typically hazardous and solutions are only added, never removed.

Industrial Stormwater Best Management Practices



There are now many manufacturers and suppliers of Biological Parts Washers.

Efficiency/Impact: Use of water based or biological parts cleaning solutions could potentially result in no hazardous waste generation, improved health for employees, and overall cost savings in material, labor, and waste disposal. Generally, cleaning with these solutions takes employee involvement in the acceptance of the use of the material and usually takes a little bit longer to perform the cleaning operation.

BMP 7 Lined Grease Containers

Activity: Vehicle maintenance, equipment maintenance, and construction involving the addition of grease to joints, couplings, bearings, etc.

Typical Pollutants: Grease (Petroleum Hydrocarbons with heavy metal additives)

Typical Problem: Grease containers when emptied still contain fair amounts of grease residue in them. Should water mix with this grease, potential adverse impact to the environment in the form of oil/water spillage may occur.

BMP: Some suppliers provide returnable containers (bulk) that, when sealed after use, minimize the potential adverse impact. Another environment friendly option is a container that is lined. After emptying, the liners can be removed and more of the grease squeezed out. The liners can then be placed in a drum for accumulation and properly disposed.



Efficiency/Impact: An increase in the amount of grease available at very little increase in labor cost will result from implementation of this BMP. If the lined containers are used, properly accumulated and disposed of after use or bulk returnable containers are used, very little risk of environmental contamination through storm water dis-

Industrial Stormwater Best Management Practices

charges will be present from this source.

BMP 8 Vehicle, Pavement and Building Washing

Activity: Pressure washing or steam cleaning of equipment, outdoor surfaces and/or vehicles. Under the 1200-Z Industrial Stormwater Permit authorized non-stormwater discharges include: Pavement washing where no detergents or hot water are used, no spills or leaks of toxic or hazardous materials have occurred (unless all spill material has been removed), and surfaces are swept prior to washing. In addition, vehicle washing without use of detergent or hot water is authorized depending upon the volume of weekly washing and discharge point. Additional controls and/or DEQ permits will be needed if using heated water, acids, bases, metal brighteners or conduct engine washing.

Typical Pollutants: Degreasers, organics, heavy metals, oil and grease and pollutants from soap, such as, phosphate and nitrogen

Typical Problem: When equipment and/or vehicles are washed outside, contaminants in the wash-water and the overspray mix with the stormwater runoff.

BMP: Ideally wash areas should be located on well-constructed and maintained, impervious surfaces with drains piped to the sanitary sewer. The wash area should extend at least 4 feet in every direction from the perimeter of the vehicle or equipment being washed. When sanitary sewer is not available there are several different approaches that can be taken depending on the size of the site and the resources available, (although permits may be required) such as:

- discharging the storm water to a properly sized grassy swale or constructed wetland,
- discharging the washwater and storm water to a collection sump for later disposal,



- discharging the storm water through an oil/water separator,
- provide a package recirculation/treatment system for washing
- relocating the washing operations to a commercial washing facility,
- contract with a mobile washer to wash the vehicles and ensure that they capture and remove the liquid and solids and properly dispose of them, and/or
- perform the washing activities off site at a commercial vehicle wash facility.

Industrial Stormwater Best Management Practices

- The use of organic solvents or non-biodegradable chemicals, soaps and detergents is prohibited.

Selection of the cleaning detergent is critical if oil/water separation unit is used. Ensure that the detergents used do not emulsify oils as this would allow the oils and grease to flow through the oil/water separator instead of being separated from the effluent. The detergent must be a low sudsing, phosphate-free, biodegradable type. Design the cleaning area with walls to keep the dirty overspray from leaving the wash area.

Commercial Alternatives:

- Hire a commercial mobile washer. These units are capable and must collect all water and solvents, therefore, are less restricted on use of acids or brighteners, engine cleaning or high pressure washing.
- Relocating the washing operations to a commercial washing facility.

Additional Source Controls:

1. All wash water runoff should be drained away from a shop area or chemical storage facility.
2. Cleaning operations should be modified to minimize paint residues (chips), heavy metals, or any other potentially hazardous materials that detach from surfaces. Modifications such as, change of cleaning agent or reduction in water pressure. Detached particles should not enter storm sewers or surface waters but rather collected for proper disposal.
3. The use of acids and/or solvents as cleaning agents for building exteriors and pavement areas is not allowed. Dry or semi-dry methods may be used to clean these surfaces (i.e., sand or other particle blasting, grind-off and vacuum technology, and ice blast technology). If blasting is used as an alternative, all solids should be swept or vacuumed and disposed of properly.
4. Facilities that conduct engine washing, acid/caustic/metal brightener washing, or steam/heated water washing shall conduct all operations on an impermeable surface. This wash water must be collected and treated prior to discharge and a Wash Water Permit is required.

Sanitary Sewer Discharge

1. Prior to disposal of wash water to sanitary sewer, minimum effluent limits must be met as required by the local Sewer Authority. It is the facility's responsibility to meet all discharge conditions before using the sanitary sewer. There are no DEQ permitting requirements if all wash water is authorized and routed into the sanitary sewer.
2. If pretreatment units are necessary they should be operated and maintained in accordance with manufacturer specifications and as required by the local Sewer Authority.

Disposal alternatives to ensure contaminated water does not enter surface waters are as follow:

1. Wash water may be collected in a sump, grit trap, or containment structure to be pumped or si-

Industrial Stormwater Best Management Practices

phoned to a vegetated area so that complete percolation into the ground occurs. An impermeable fabric liner may be needed for the lagoons or constructed wetlands to protect groundwater. All criteria set forth in OAR 340-40 must be met for groundwater quality protection. Treatment options include, but are not limited to:

- grit trap for suspended solids removal
- oil/water separator removes floating oil
- ph adjust unit will neutralize acids and caustics
- advance treatment alternatives

➤ The treatment system must be, at all times, properly operated and maintained. Records of maintenance activities should be maintained on-site for DEQ inspection.

2. Disposal of wash water should occur on ground surfaces with vegetated cover and may not cause any erosion. Depending on the amount of vehicles washed in a week, a permit may be required.

3. If facility is close to surface waters the wash water may be disposed to a dry grassy swale, a minimum of 250 feet in length before the waterbody. Complete percolation in the swale should occur with no direct discharge to the surface water. Discharge into a grassy swale for treatment should not occur within 24 hours after a rainfall event or if water remains ponded in the swale. A distance of 250 feet was based on a hydraulic conductivity of 0.2 gal/ft/day, volume per day of 150 gallons, and a swale with a width of 3 feet.

Efficiency/Impact: The use of a recycling system will not only reduce or eliminate the contaminant discharge to stormwater or sanitary sewer but it will greatly reduce the amount of water used in the process. The use of a bioswale with an oil/water separator will likewise virtually eliminate the total suspended solids, oil and grease, and heavy metals discharged provided both are properly sized. A portable collection system will provide the collection of the contaminants provided the collection system is large enough to capture significant amounts of the overspray.

BMP 9 Oil/Water Separators

Activity: Any site that has steel, equipment or vehicles stored outside and has a potential for oily storm water discharges.

Typical Pollutants: Oil and grease, PAH, and suspended solids

Typical Problem: Structural steel and plate arrives on the site from the supplier coated with oil to inhibit corrosion. As storm water comes in contact with the steel the oil disperses and runs off. Equipment stored outside has grease and oil on it that washes off when contacted by storm water. Vehicles not only have the normal oil and grease associated with them but they also have road film which contains oil.

Industrial Stormwater Best Management Practices

BMP: Installation of a properly sized oil/water separator can reduce the amount of both Total Suspended Solids and Oil and Grease in the storm water run-off. Several types of oil/water separators are available (Gravity, Coalescing, Centrifugal, Carbon Absorption, Ultrafiltration, etc.). Gravity Oil/Water Separators are generally the most economical provided emulsifying chemicals have not been used upstream of the separator, dirt is not a major contaminant, and high shear centrifugal pumps are not used to pump the water to the separator.

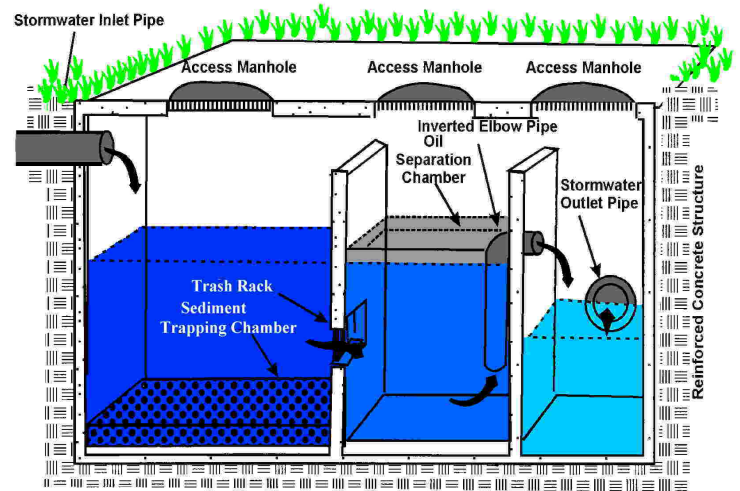

There are three basic types of oil/water separators, spill control (SC), API (longer retaining time), and coalescing plate (CPS) recommended for use in all pipe drainage systems conveying runoff from paved areas, subject to vehicular use or storage of chemicals, prior to discharge from the project site or into an open drainage feature. All three types have the following basic application/selection criteria:

- Urban residential runoff usually low flows
- Suitable for smaller sites, draining 5 or less acres
- Land uses associated with include: industrial, transportation, log storage, airports, fleet yard, railroad, gas station, vehicle/equipment dealers and repair, construction and petroleum storage.
- SC can be effective at retaining small spills but does not remove dispersed oil droplets because they have a short residence time. SC type should be required when the site stores petroleum based products and spills are likely.

API used where there is a relatively high likelihood of dispersed oil contamination. API/CPS should be used in areas with high traffic volumes (2,500 vehicles per day), at sites that are used for petroleum storage/transfer, scrap and wrecking yards, or at sites where heavy equipment is stored and/or maintained. Oil/water separators cannot deal well with heavy sediment loads and should be used in conjunction with detention, biofiltration, or water quality treatment system to protect groundwater. CPS consist of a bundle of plates made of fiberglass or polypropylene installed in a concrete vault. The plates improve the removal of oil and fine suspended sediments and assist in concentrating the pollutants for removal. CPS requires frequent inspection and maintenance to operate as designed. A mechanism should exist for the system to be bypassed, so the system can be taken off line for maintenance. Oil and sediment removed from devices may qualify as hazardous waste and should be tested prior to disposal. Oil separators should be sized for a local six-month reoccurring 24-hour design storm. Larger storms should be diverted from the separators.

Efficiency/Impact: The use of gravity oil/water separators in the storm water outflow can greatly reduce the free oil droplets larger than 0.015cm (150 microns). Ultrafiltration can virtually eliminate oil in the storm water outflow. Fouling of membranes may be

Industrial Stormwater Best Management Practices

come a concern with Ultrafiltration although some newer vibrating membranes show great promise for keeping the membranes clear during backflushing.

BMP 10 Oil/Water Separators for Air Compressors

Activity: The use of compressed air.

Typical Pollutants: Oil

Typical Problem: Compressed air systems typically absorb or condense moisture from the ambient air. Fine oil is released to the compressed air in the compression cycle. The condensed water is either manually drained out of the compressor, filters, and/or the air receiver tank or is automatically drained by a timed valve system. This condensate may be discharged to the ground or to a location that can leak or be spilled into the outside environment. Storm water then flushes this oil to the storm water outfall.

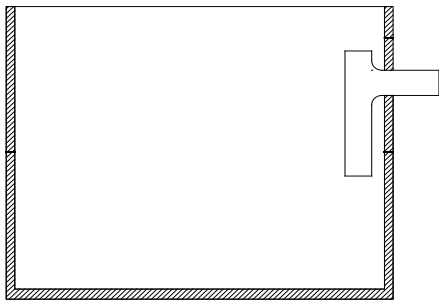

BMP: Install an oil/water separator especially made for compressors and receiver tanks or manufacture a simple separator similar to the one shown on the following page and siphon off the oil. Discharge the remaining water to the sanitary sewer if it is available on-site.

Efficiency/Impact: Oil from this source can be greatly reduced or eliminated and loading to the storm water conveyances will be reduced.

BMP 11 Oil and Sediment Trap Catch Basins

Activity: Storm water runoff from commercial or industrial sites to standard catch basins or drains.

Typical Pollutants: Oil, PAH, and sediment

Typical Problem: On sites that use standard catch basins or drains there is no retention of any oils or sediments. This could result in excessive discharges to storm water of these pollutants.

Industrial Stormwater Best Management Practices

BMP: Retrofitting drains to standard sediment and oil trap (Lynch style) catch basins properly designed for the flow-through rate and when properly maintained can reduce oil and grease levels in the storm water discharge significantly.

Efficiency/Impact: Proper sizing and maintenance can reduce the discharge concentrations of oil and grease to below 10mg/l and suspended solids including heavy metals by from 10% to 42% depending on the influent flow rate and the accumulated sediment level already in the lower sump with the lower efficiency corresponding to the higher flow rates. It is extremely important to remove the accumulated sediments and oil in the catch basin when the sediment retention capacity (depth below the bottom of the outfall pipe) is reduced by 50 % but to a depth of not less than 18 inches to the outfall pipe.

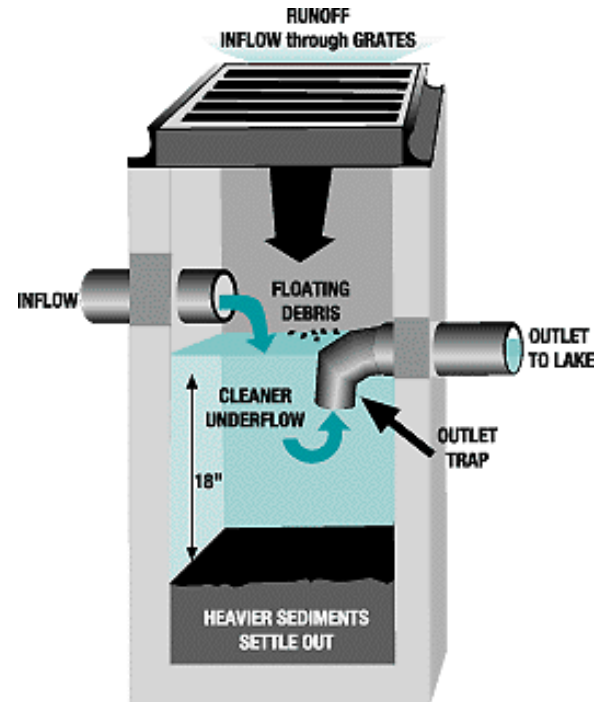

Note: An additional issue on some industrial sites is the lack of a single or common sampling point which may require that sampling be accomplished from the catch basin(s). The catch basin is typically the worst place to sample in that it is where the pollutants are concentrated and retained and it is not really representative of the pollutant concentrations leaving the site. Sometimes an insert bag may be used in the catch basin as a BMP to remove sediments. Moving this bag to the side typically re-suspends TSS that was clinging to the bag thus increasing the TSS in the samples collected. Consider using a pipe Tee instead of an inverted elbow or flat steel invert/cleanout in the catch basin outfall. If the pipe and tee are four inches or more in diameter, it is possible to dip the sample bottle in the clean side of the catch basin and if the tee were extended up through the grate and a removable cap was placed upon it, the insert bag would not have to be disturbed nor would the grate have to be removed in order to sample. Another option for sampling is to excavate to the outfall piping on the discharge side of the catch basin and replace a section of the 45 degree angled drain pipe with a sampling sump with access to a sealed cover at ground level. The depth to the angled outfall pipe would probably be around 18 inches or less in most cases.

Industrial Stormwater Best Management Practices

BMP 12 Containers for Dust Collectors

Activity: Arc furnace or mechanical removal operations (grinding, sanding, shot blasting, etc.) that create dust which is collected in baghouses.

Typical Pollutants: Metal fines, suspended solids in storm water

Typical Problem: Mechanical removal operations involving the removal of metal, paint, wood, and other materials generate dust that is collected in bag filter houses. Arc furnaces will generate a metallic fume that condenses out as a dust on the way to the baghouse. The baghouses must discharge the dust collected to a dumpster, drum, or bin. If the connection between the baghouse and the collection container is not airtight then, dust leaks out into the environment. Storm water will contact this dust and convey it off-site, typically causing a TSS discharge problem.



BMP: If a drum is being used for collection of the dust, manufacture from a removable drum top a flange or sleeve that a flexible boot can be clamped to and attach the sleeve to both the discharge point on the baghouse and to the drum sleeve. Use quick release clamps to attach the removable drum top to the drum. If a dumpster or other large container is used to collect the dust, manufacture a solid reinforced cover for the container using rubber sealing strips and

Industrial Stormwater Best Management Practices

clamps or bolts to hold the cover in place. The cover should have a sleeve or flange that attaches to a flexible boot which is attached to the discharge point on the baghouse. It may be necessary to also include a vent line from the dust receiving container back into the dust collector in order to relieve the air pressure resulting from the dust dropping down in to the collection container.

Spillage that occurs from connecting and disconnecting to the flexible boot should be immediately cleaned up using a vacuum. A fixed vacuum duct may be plumbed into the inlet of the dust collector with a valve so that the spillage can be reintroduced into the dust collector. Also, frequent vacuum sweeping of the area around the dust collector should be performed.

Efficiency/Impact: Through the use and proper maintenance of the container covers most of the dust can be contained significantly reducing the amount of dust that could leak out to the environment. This would, in turn, greatly reduce the impact from this source of suspended solids and metals to the storm water discharge.

BMP 13 Ozone Generators for Cooling Towers

Activity: The use of cooling towers with the associated water treatment chemicals and blowdown discharges.

Typical Pollutants: Biocides, algacides, fungicides, and corrosion inhibitors (BOD, COD); suspended solids; zinc; and copper



Typical Problem: Chemicals such as Biocides, Algacides, and Corrosion Inhibitors are added to cooling towers to prevent biological growth, and to reduce scaling and corrosion. Periodically cooling tower water must be blown down in order to remove sediment and particulate buildup in the cooling tower sump. This water should be discharged to sanitary sewer but may not be in areas where a sanitary sewer is not available. Even when the water is discharged to a sanitary sewer an upset can occur in which the cooling tower sump water is discharged to outside areas and comes in contact with storm water. This water can contain elevated levels of copper, zinc, and chemicals with high BOD₅ and COD.

BMP: Use ozone instead of chemicals to control biological growth and scaling. Ozone is a powerful oxidizing agent. It has one and one-half times the oxidizing potential of chlorine. A properly operated and controlled ozone treatment system will not allow microorganisms that secrete the glue-like substance called mucilage to survive and will break down existing mucilage. Microbiological induced corrosion (MIC) can be controlled through the use of ozone. The pH of the water when using ozone is around 8 in comparison to levels typically below 7 when using chemical treatment. Cooling tower sumps can be vacuumed out using a swimming pool type vacuum. With little or no biological growth, the absence of chemical additives, and the absence of scaling sediment, particulate accumulation can be restricted to airborne particulates for the most part which should reduce the frequency for the need to remove sediments and particulates by blowing down the sump. Use of a swimming pool vacuum cleaner could eliminate almost all blowdown.

Industrial Stormwater Best Management Practices

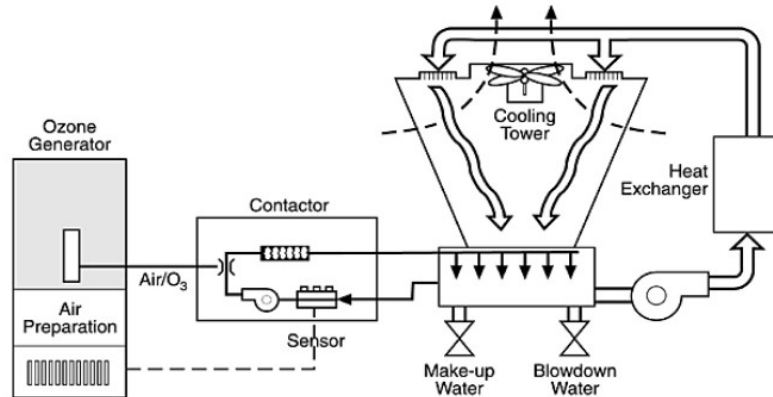

An alternative to introducing ozone is the use of ultraviolet light disinfection to control microbial growth in cooling tower water. In this case the cooling tower is recirculated through the UV unit which kills organisms attempting to grow in the water. Blowdown will still have to occur but will probably be required at a reduced frequency over that necessary when chemicals are used. The computer chip industry has used this method for their ultrapure water processes for years and the machinery coolant recycling equipment industry has also been using UV treatment units to eliminated biological growth in their coolant recycling equipment.

Efficiency/Impact: By replacing chemical additives with ozone or UV treatment and using a swimming pool vacuum cleaner for sediment removal, potential pollutants from this source to the storm water conveyances can be reduced or eliminated.

BMP 14 Cartridge Filtration

Activity: Operations with exposed copper and/or galvanized piping, galvanized siding and/or roofing materials, cathodic protection coatings of copper such as may be found on boats, or other exposed copper, brass, and/or zinc coated materials that are exposed to storm water may have significant levels of these metals present in their storm water discharge. Operations involving heavy vehicle traffic may also have metals in their storm water discharge such as copper from brake shoes and clutches or zinc from tire wear.

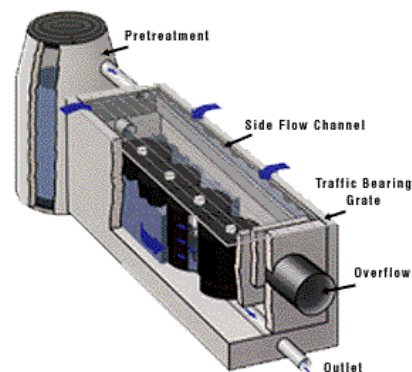
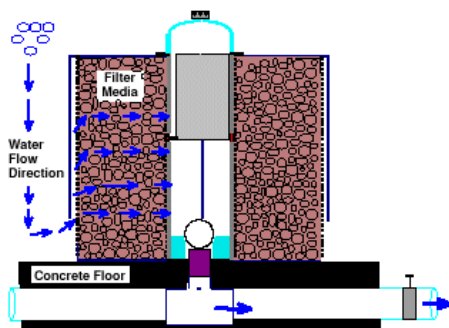

Vault type filters

Industrial Stormwater Best Management Practices

Typical Pollutants: Copper, zinc, PAH, and Total Suspended Solids

Typical Problem: Dust from tires (1% Zinc wear rate = 90mg/km/tire) and clutch/brake mechanisms, deterioration from galvanized building materials or corrosion and/or oxidation of copper piping and fixtures cause discharges of particulate and dissolved chemical forms of copper and zinc to the environment when contacted by storm water. Copper based cathodic protection on boats and other equipment generates chemical and particulate forms of copper that becomes combined with storm water.

BMP: The installation of properly sized compost filtration units can remove significant amounts of both chemical and particulate forms of some heavy metals, including copper and zinc, and reduce TSS levels in the storm water discharge. Colloidal particulate levels from clay soils should also be reduced effectively.

Effectiveness/Impact: Evaluation of existing sites over a three-year period show that the mean reductions of pollutants in storm water for the following were achieved:

For Compost Media

TDS	22.4%	Turbidity	91.8%
COD	70.4%	Total Phosphorus	44.9%
Lead	44.9%	Zinc	83.2%
Copper	65.3%	Oil & Grease	80.9%

In general, reductions for Heavy Metals can be expected to be in the range of 65 to 95% and for Oil & Grease up to 85% for a properly designed and sized system.

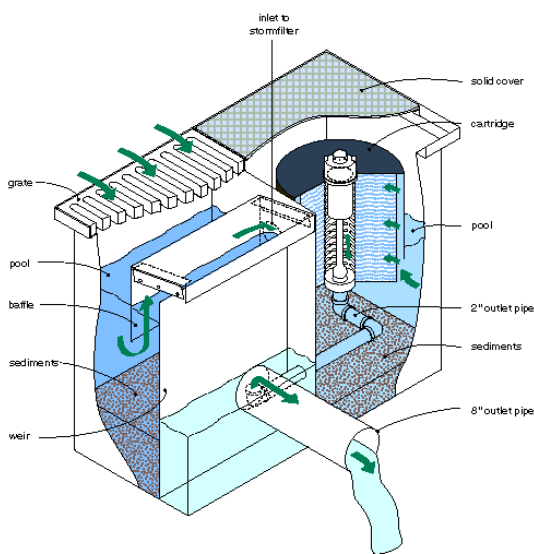

Catch Basin type filter



Roof Downspout type filter

Industrial Stormwater Best Management Practices

BMP 15 Sweeping

Activity: Operations that have exposed copper and/or galvanized piping, galvanized siding and/or roofing materials, or other exposed copper, brass, and/or zinc coated materials exposed to storm water can have significant levels of these metals present in the storm water discharge. Operations involving heavy vehicle traffic also produce elevated metal levels in storm water from vehicle brake shoes or clutches (copper) and tire particles (1% zinc wear rate = 90mg/km/tire).

Typical Pollutants: Total Suspended Solids, PAH, Copper, Zinc.

Typical Problem: Dust from tires and clutch or brake mechanisms, deterioration from galvanized building materials, or corrosion and/or oxidation of copper piping and fixtures cause discharges of particulate and dissolved chemical forms of copper and zinc to the environment when contacted by storm water. Copper based cathodic protection on boats and other equipment also generate dissolved chemical and particulate forms of copper that can become combined with storm water.



BMP: Sweeping of paved roads, parking lots, and storage areas with a type of vacuum sweeper that incorporates HEPA filtration or other high efficiency method of filtration of the exhaust air from the sweeper to trap the very fine metallic particles found in road or parking lot dust can reduce these discharges to storm water.



Ensure that good control measures are implemented when dumping the contents of the sweeper and practice proper disposal methods for the emptied contents to ensure that there is no adverse environmental impact after spending so much effort in the initial clean-up.

Industrial Stormwater Best Management Practices

Efficiency/Impact: This type of Sweeper is capable of collecting and containing up to 99.6% of particles as small as 2.5 microns in size. The elimination of particulates in storm water is related to the frequency of sweeping as is shown comparisons of various types of sweepers in the following graph.

There are sweeper certifications, PM-10 and AQMD, which both are high efficiency sweepers that can contain small particle sizes. Some models, as shown below, contain hoppers which can be emptied directly into a dumpster or dump and debris as it is picked up from the floor and passed through a polyester filter. When the hopper is full, it can be emptied directly into a dumpster or dump truck, minimizing the chance of particulate matter being re-released into the air. Information from the manufacturer, reports that the sweepers will retain particles 10 microns, or 0.001 mm, or larger. The smaller size of the model and four-wheel steering makes it easy to maneuver in small spaces that traditional sweepers would not fit.

BMP 16 Battery Storage



Activity: The outdoor replacement or storage of lead/acid or nickel/cadmium batteries and the long time storage of vehicles or battery powered equipment outside.

Typical Pollutants: Soluble metals such as lead, nickel, or cadmium, Sulfuric acid

Typical Problem: When batteries are replaced, the used batteries are generally stored around a site until enough have been collected to make it feasible to either have them picked up or shipped out to a battery recycler. These batteries are usually stored on the shop floor or outside without containment and with no thought of exposure to storm water. Sometimes electric lift trucks, pallet jacks, welders, portable powered pumps, etc. are stored outside with the batteries used for starting or for operation left in place and poorly protected from storm water contact. Lead sulfate usually present on lead/acid batteries or in the spillage of the lead/acid or nickel-cadmium/acid solution can create soil contamination and a storm water run-off problem.

Industrial Stormwater Best Management Practices

BMP: Batteries should be stored in a contained area protected from the weather. Containment pallets can be used to collect any acid spillage. The pallets should be placed inside of buildings to keep storm water from coming into contact with the batteries.



Efficiency/Impact: Containment, protection from the weather, and frequent shipment to the recycler can minimize or eliminate the adverse storm water impact from this potential source of contamination.

BMP 17 Wrecked Vehicle Storage & Scrap Metal Recycling



Activity: Wrecked or Damaged Vehicle Storage or Scrap Metal Recycling

Typical Pollutants: Antifreeze (ethylene glycol), gasoline, oil, grease, brake fluid, diesel

Industrial Stormwater Best Management Practices



Typical Problem: Depending on the damage to the vehicle, fluids may leak due to the damage incurred and/or the damage may expose oily components of the vehicle that would normally be protected from the weather. Storm water will contact these contaminants and infiltrate the ground, contaminating the soil and groundwater at the site and combining with storm water runoff, depending on the rainfall and soil conditions, to waters of the State.

BMP: Provide containment of wrecked vehicles on impervious surfaces. If wrecked vehicles are stored on impervious surfaces, the drainage from those surfaces should pass through an oil/water separator prior to discharging to a storm water drainage system or to a storm water sewer. Insure that all fluids are completely drained from wrecked vehicles. If possible, provide a roofed storage area to prevent storm water contact with wrecked or damaged vehicles.



Fluid Vacuum Extraction System



Fluid Vacuum Drill System

Remove engine oil, transmission fluid, rear-end oil, antifreeze, Freon, and any other fluids before storing the vehicles on the site.

Industrial Stormwater Best Management Practices



Fluid Gravity Drain System

Efficiency/Impact: Storage of all vehicles under a roof with a storm water divergence berm should, by eliminating storm water contact and allowing collection of potential contaminants, eliminate storm water concerns. Providing an impervious surface for the vehicles should eliminate the concern for groundwater contamination. Draining of the vehicle fluids would minimize but not eliminate the contaminant(s) concern.

BMP 18 Paint Stripping

Activity: Stripping coatings (paint, plastic, etc.) from metal and wood surfaces outdoors.

Typical Pollutants: Hazardous stripping chemicals, lead from old lead based paints, zinc chromate from old paint preparations, metal particulate, low pH, and increased suspended solids

Typical Problem: Stripping of wood and metal parts is usually accomplished with the use of chemicals that have health and environmental hazards. High pressure water blasting can cause increased runoff and can, in the case of blasting wood, damage the surface. Sand blasting creates a large amount of solids to dispose, i.e. the sand plus the paint removed which may be considered hazardous waste.



BMP: Consider using dry ice or baking soda abrasion type removal of old surface coatings instead of chemical or sand blasting. The dry ice system removes the surface

Industrial Stormwater Best Management Practices

coating and leaves only the material removed on the ground, which can be vacuumed or swept up. Using baking soda as the blasting agent leaves the material removed plus baking soda which is not typically harmful and can be fairly easily separated from the paint removed with it by using reclamation equipment or through dissolving the baking soda in water and separating the paint by sedimentation and then evaporating the water. Use a removable ground cover before blasting to ease the cleanup efforts at job completion.



Another consideration is the use of a temporary or portable structure to contain and isolate the work and debris from the stripping from contact with storm water runoff such as the temporary structure on the left used to protect a boat during hull stripping.

Efficiency/Impact: By placing a removable ground cover such as a plastic tarp down prior to conducting the work and using one of the blasting methods mentioned or building a temporary structure, virtually all of the removed material can easily be cleaned up with minimal volumes of material involved. Disposal will be less costly when less volume of combined materials are involved over the conventional sand blasting methods. The overall impact to the environment and especially to storm water discharges will be minimized or eliminated.

BMP 19 Equipment Covers

Activity: Storage of used or new equipment outside exposed to rain and snow fall.

Typical Pollutants: Metals, TSS, Oil & Grease



Typical Problem: During the removal and installation of production or facilities equipment, the equipment is typically stored outside exposed to the elements for short durations in the case of new equipment being installed or for longer duration for equipment removed from service. This may allow rainwater or snow melt to wash oil and grease along with metal solids into the stormwater runoff.

Industrial Stormwater Best Management Practices

BMP: Obtain tarps or plastic sheeting and wood bracing or pallets in the case of used equipment to keep the equipment above the surface water runoff and to eliminate the exposure of the equipment to rainfall and snowfall. The tarps or sheeting must be securely anchored to minimize the maintenance activities that may be needed to keep the protection in place.

Efficiency/Impact: Except for the times that the equipment is being placed in the buildings or unloaded/loaded on trucks for shipping this source of contaminants should be able to be eliminated.

BMP 20 Brake Shoe Replacement

Activity: Vehicle repair/brake shoe replacement including materials handling vehicles.

Typical Pollutants: Asbestos, copper, total suspended solids



Typical Problem: Dust in the brake shoe/wheel housing is typically disturbed and can be released into the environment when brake shoes are replaced. This dust will migrate from inside buildings to outside areas creating an asbestos and/or increased copper discharge when contacted by storm water.

BMP: Use the Low Pressure/Wet Cleaning Method described below for dust removal in brake shoe housings. Some older brake shoes may still be present which contain asbestos. Some new brake shoes on mobile equipment still contain asbestos. Brake shoes contain copper compounds in addition to other materials. The dust in the brake shoe housing can, because of its micron and sub-micron size, escape the shop area and contaminate the site to a level that, when contacted by storm water, may exceed the copper discharge benchmark. If a vacuum is used, ensure that it is of a type that has a HEPA filtration system that can retain the micron sized particles.

Low Pressure/Wet Cleaning Method

- A drip pan shall be placed under the brake assembly, positioned to avoid splashes and spills.
- The reservoir shall contain water containing an organic solvent or wetting agent. The flow of liquid shall be controlled such that the brake assembly is gently flooded to prevent the asbestos-containing brake dust from becoming airborne.
- The aqueous solution shall be allowed to flow between the brake drum and brake support before the drum is removed.
- After removing the brake drum, the wheel hub and back of the brake assembly shall be thoroughly wetted to suppress dust.
- The brake support plate, brake shoes and brake components used to attach the brake shoes shall be thoroughly washed before removing the old shoes.

Industrial Stormwater Best Management Practices

- In systems using filters, the filters, when full, shall be first wetted with a fine mist of water, then removed and placed immediately in an impermeable container, properly labeled and disposed.
- Any spills of asbestos-containing aqueous solution or any asbestos-containing waste material shall be cleaned up immediately and properly disposed.
- The use of dry brushing during low pressure/wet cleaning operations is prohibited.

Efficiency/Impact: Use of the wet method for removing the dust in the wheel/brake housing or the use of a HEPA vacuum will significantly reduce or eliminate this practice as a source for copper or asbestos in storm water. It will also significantly reduce the potential health hazard associated with asbestos exposure to employees.

BMP 21 Employee Environmental Training

Activity: Employee environmental education and training.

Typical Pollutants: All



Typical Problem: Many employees are not aware of the potential adverse impact the company's business may have on the environment or how they personally can affect those impacts. They may not have even thought about environmental impacts and cannot recognize bad practices. Some may not know whom to inform of upsets or potential problems.

BMP: Provide periodic training that describes the potential adverse environmental impacts of the business and methods for preventing those impacts. The training should:

- Describe how the company is being environmentally responsible.
- Encourage employees to bring forth suggestions for improving the environmental performance of the business.
- Describe how and to whom the employee should report potential environmentally related concerns.
- Inform the employee of what to do.
- Provide incentives to employees to offer ideas for improvement.

Record attendance of the training. Show graphics in the presentation such as pictures of the various parts of the site under discussion during the presentation. Schedule regular inspections of the site looking for possible conditions or operations that could produce potential adverse environmental impacts. Use a team approach to this inspection, as it is too easy, even for professionals, to acquire tunnel vision during the inspection. During the site inspections, write up every questionable item or practice for later thought or resolution. To resolve or dismiss a suggestion or

Industrial Stormwater Best Management Practices

question during the inspection may distract from the process of the inspection or discourage employees from providing their input. Do not associate biodegradable with environmentally safe. Verify that the company is not moving wastes from one media to another, i.e. water to air, storm water to groundwater, etc.

Before the training takes place, analyze the potential problem areas of the site and the potential for how the site's manufacturing process can adversely impact the environment. Develop the training program presentation around these areas. Ask the question "what message am I trying to present?" and thoroughly provide the information necessary to answer the question. How and to whom should it be reported? Involve employees in the presentation through discussion items. Don't over look providing this training to temporary employees.

Efficiency/Impact: By making employees aware of the potential adverse impacts of the business and encouraging employees to offer ideas and suggestions, employers will see, not only a decrease in pollutants in their storm water discharge but, potentially in air, hazardous waste, and other media.

BMP 22 Housekeeping

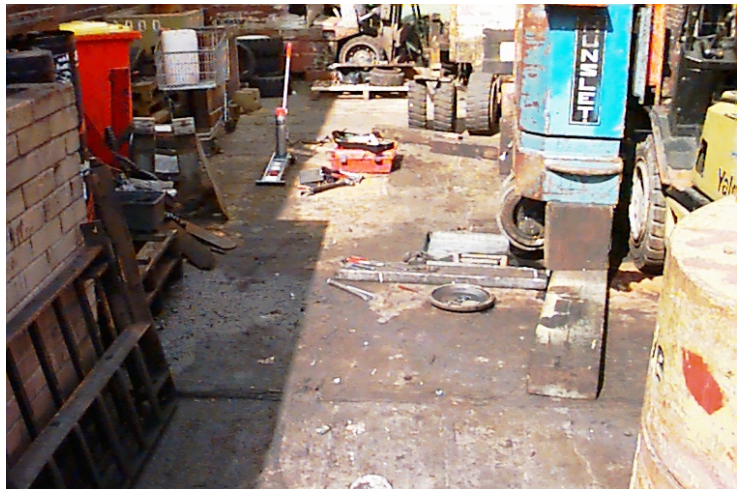

Activity: Any site that stores material outside.

Typical Pollutants: Total suspended solids from erosion, oil and grease, BOD₅, heavy metals.

Typical Problem: Poor housekeeping inside and outside on a site provide a possible indicator of the degree of the site's compliance with environmental, health and safety regulations. In addition, poor outside housekeeping tends to discharge paper, cardboard, wood, pallet and box strapping, and other wastes to the storm water conveyance system. These wastes can plug the storm water conveyances, and divert storm water flows causing increased erosion and localized flooding.

Industrial Stormwater Best Management Practices

BMP: Good housekeeping includes:

- Orderly storage of bags, drums, and piles of materials and chemicals; prompt cleanup of spilled liquids;
- Frequent sweeping, vacuuming, or other cleanup methods for accumulated dry chemicals and materials can cut down on possible storm water contamination;
- Proper disposal of toxic and hazardous wastes, and
- Removal of accumulated scrap and spare parts.

Good housekeeping doesn't just happen. It occurs when it is well planned, scheduled, and when upper management demonstrates its importance by participating in regular inspections. Set aside time in the work schedule for cleanup activities.

- Schedule personnel to be responsible for the cleanup and rotate every employee through the schedule.
- Periodic inspections and regular site cleanup can prevent problems from occurring. The frequency of outside inspections should be increased during the October through May rainy period.
- Encourage employees to pick up trash when it is seen and to report when more intensive clean up is needed.

Every site that is environmentally responsible has good housekeeping activities. Most sites with environmental problems do not have good housekeeping activities.

Efficiency/Impact: The implementation of a formal housekeeping program with education and encouragement of employees can reduce or eliminate pollution by bringing the importance of how materials are stored and how trash can affect the storm water discharges to their attention along with the importance that management places on the issue. A regular maintenance schedule for storm water conveyances minimizes erosion and visually verifies the condition of the storm water discharges. Several typical pollutants in storm water can readily be identified by visual observance.

Industrial Stormwater Best Management Practices

BMP 23 Lawn Care



Activity: Facilities having lawns or vegetated areas.

Typical Pollutants: Fertilizers, pesticides, herbicides, fungicides, phosphorus, nitrogen, zinc, copper, and pH.

Typical Problem: Lawn care entails the application of fertilizers, herbicides, pesticides, and water in order to achieve a rich vibrant lawn. Weeds are quite often controlled through the application of chemicals. Over fertilizing and the over-application of pesticides and herbicides can contaminate storm water. Too much irrigation can wash these chemicals off the site into storm water conveyances, streams, rivers, and lakes. The nutrients, phosphorus, nitrogen, and pH can be detrimental to slow moving water bodies by encouraging algae growth. Herbicides and pesticides can adversely impact human health, fish and other wildlife. All of these pollutants can significantly affect the beneficial uses of water bodies.

BMP: If a landscape contractor is hired to take care of the lawn and other vegetated areas of the site, ensure that they do their part to protect the environment by applying the appropriate amount of chemicals. Encourage them to investigate more environmentally friendly alternatives to the use of chemicals such as a thin layer of compost on top of the lawn in the fall.

A few simple precautions can minimize adverse environmental impacts from lawn care. No matter what chemicals are used, over-watering can move the chemicals in to the storm water conveyance system. Use rain measuring equipment to automatically prevent automatic lawn sprinklers from turning on. In the Northwest, watering to a depth of six inches a couple of times a week is sufficient for a lush green growth. Always water in the morning, between 6 a.m. and noon, or in the evening around sundown so that the water has time to infiltrate before it evaporates

Fertilization:

For lawn fertilization, 1,000 square feet of lawn requires 0.5 pound of nitrogen per month of active growth (~8 months in Portland area ~ 4 pounds). A good ratio for fertilizer is 3 parts nitrogen

Industrial Stormwater Best Management Practices

to 1 part phosphorus to 2 parts potassium to 1 part sulfur (3:1:2:1). Use a slow release fertilizer such as one containing water insoluble nitrogen (WIN). After determining the amount of fertilizer to use per year based upon the growing season, apply the fertilizer in four equal applications of approximately one pound per 1,000 square feet each application, i.e. 1/4 in early spring, 1/4 in late spring, 1/4 in late summer, and 1/4 in the fall.

Have your site's soil tested to determine if other materials such as iron (for low pH soil < 6.8), boron, chlorine, copper, manganese, molybdenum, nickel, and zinc should be added for a healthy lawn. If soil testing indicates that one or more of the additives above is needed, contact your county Extension Agent, a lawn and garden center, or a master gardener for advice on how much of the additives to apply for optimum growing conditions.

Fertilizer over-use, over watering, and watering at the wrong time of the day set up a good environment for many grass diseases and for invasion by weeds that are very competitive with the grasses in the lawn.

Pest Management:

Pest management can be conducted in an environmentally friendly manner through:

- **Knowledge**
 1. knowing the variety of grass in your lawn;
 2. knowing its growth characteristics; and

- **Identification**
 1. identifying the weeds present;
 2. identifying the grass disease present; and/or
 3. identifying the insect pests present
 - a). Note where the pest is located on the lawn
 - b). Draw a picture of the pest or collect a sample
 - i. Research in books for a match of the pest found to a photograph;
 - ii. Contact local County Extension office for assistance and advice; or
 - iii. Take sample to local home and garden center for identification.

Weed removal is best accomplished by hand-pulling.

Maintain a buffer strip next to waterways. Do not apply fertilizer or pesticides to this strip. It is used to absorb excess fertilizer from the care of the rest of the lawn. It will also retain excess nutrients and sediments.

Healthy Lawn

Step 1: Lawn conversion Convert lawn areas into groundcover, trees, shrubs, or meadow plantings. For a low input approach, replace the grass underneath mature trees with groundcover. For an even lower input approach, examine your lawn for potential conversion areas and plant groundcovers, trees, shrubs, or perennials in all areas where grass is hard to grow. For the lowest input approach, use turf only where

Industrial Stormwater Best Management Practices

it is the best plant to fulfill a particular function, such as providing children's sports area.

Step 2: Soil building

Provide a strong foundation for the lawn. For a low input lawn, get a soil test to determine the soil's pH and fertility. You may not need to add any lime or fertilizer to your lawn. For a lower input lawn, test for soil compaction. Can you sink a screwdriver into the ground without pounding or is the soil compacted? If the soil is compacted, aerate with a hand corer or mechanical aerator. For the lowest input lawn, examine the soil's texture- neither extremely sandy soils nor extremely heavy clay soils make for good lawns. Next count earthworms - if none can be found in a square foot of soil, there's a problem. A healthy soil community has over 10 per square foot. With this basic understanding of soil acidity, fertility, compaction, texture, and earth-worms, one can build soil that supports dense, healthy turf.

Step 3: Grass selection

Choose the type of grass that will be easiest to grow. For a low input lawn, select hardy grass species adapted to your region's climate. For a lower input lawn, select named grass varieties to meet your specific needs. For the lowest input lawn, try the new low input slow growing or dwarf grass mixes.

Step 4: Mowing and thatch management

Mow to the right height at the right time and recycle clippings. For a low input lawn, leave clippings on the lawn to provide nutrients and moisture. For a lower input lawn, set mowing height as high as possible. For the lowest input lawn, adjust mowing height and frequency during the growing season and monitor thatch levels.

Step 5: Minimal fertilization

Give the lawn what it needs but don't overfeed. For a low input lawn, recycle clippings and (in the right season) apply commercial fertilizer at half the recommended rate; avoid weed and feed formulations and don't fertilize if rain is imminent. For a lower input lawn, fertilize as above but use encapsulated nitrogen or an organic product instead and fertilize only if soil tests show it's needed. For the lowest input lawn, substitute home generated compost for commercial organic or encapsulated products.

Step 6: Weed control and tolerance

Establish a realistic tolerance level for weeds and use less toxic control methods to maintain it. For a low input lawn use least toxic weed control methods such as: cultivation, solarization, flaming, mowing, or herbicidal soap. For a lower input lawn, grow strong healthy grass and it will crowd out weeds. For the lowest input lawn, broaden your definition of "lawn" to include weeds that perform desirable functions.

Step 7: Integrated pest

Establish a realistic tolerance level for pests and use least toxic con-

Industrial Stormwater Best Management Practices

management

control methods to maintain it. For a low input lawn, use least toxic control methods such as removing or trapping pests, introducing biological control agents, or apply least toxic chemical controls such as insecticidal soaps. For a lower input lawn, grow strong, healthy grass that can resist attack. For the lowest input lawn, use cultural controls to prevent infestation, protect natural predators, and add beneficial soil microbes.

Step 8: Sensible irrigation

Practice water conserving landscaping techniques.

For a low input lawn, water infrequently, in the early morning, but soak the lawn well. For a lower input lawn, water only when the lawn definitely needs it, and calibrate sprinklers. For the lowest input lawn, accept that the grass may not be green year round.

Efficiency/Impact: Proper maintenance of lawns and vegetative strips can be pleasing to the eye and provide environmental benefits such as reduced pollution to streams, rivers, and lakes, cooler runoff, reduce sediments in the runoff, and in some cases reduce other pollutants from the site. The degree that this BMP will be effective is directly proportional to the degree of involvement in the care of the lawn or the degree of caution exercised in selecting a lawn care contractor and the degree that the watering system is in tune with the lawn and the weather.

BMP 24 Dumpster Covering



Activity: Storage of general rubbish or food rubbish outside in dumpsters.

Typical Pollutants: Suspended solids, nutrients, bacteria, dioxin, chemicals

Typical Problem: Waste materials are typically removed from inside the site buildings to a collection container (dumpster) outside of the buildings. If these dumpsters have an open top or the top is left open at times when materials are not being dumped into them, storm water makes contact and will mix with the wastes and leak out to the storm water discharge conveyances for the site.

Industrial Stormwater Best Management Practices



BMP: There are two effective methods for addressing this concern. At the end of a building, extend the roof over the area where the dumpsters will be placed to keep storm water out. Slope the floor that the dumpsters are sitting on to a drain where the contaminated storm water/dumpster drainage can be collected and discharged to a sanitary sewer, if necessary.

The other method is to ensure that covers are on all of the dumpsters and that the covers are lowered when wastes are not being discharged into them. The second method has the most risk in that this method relies on employees always performing the proper procedure and many different situations can arise that may interrupt the procedure and prevent it from occurring. No matter which method is used, ensure that no storm water catch basin is located close by.

Efficiency/Impact: Either method for protecting wastes from storm water exposure will minimize or eliminate storm water pollution from this source. The method that relies on the least effort from employees is usually the most reliable.

Industrial Stormwater Best Management Practices

BMP 25 Semi-Trucks and Trailers



Activity: Trucking firms or other operations in which semi trailers are parked on site and dollies are used to attach to the trailers to move the trailers around the site or operations in which semi tractors are used on site.

Typical Pollutants: Oil and grease

Typical Problem: Fifth wheel hitching mechanisms used to attach semi-tractors or Yard Goats to semi-trailers have a thick coating of grease on them to minimize the friction encountered and to ease the attachment process during connection of tractors or Yard Goats to the trailers. When the Yard Goats or semi-tractors are parked and not attached to trailers the grease on the fifth wheel is exposed to storm water. This allows the storm water run-off to pick up the oil and grease.



BMP: Manufacture or purchase a quick install cover to slip over the hitch. A simple lightweight inexpensive cylindrical slip-on cover could be made out of fiberglass. Ensure that all operators of the equipment are instructed to place the cover over the hitches when they are not being used. Changing from the lubricated type fifth wheel hitch to a Teflon non-lubricated type is a better approach but, if rental or transit trailers are in use frequently this may not be a viable option due to the requirement that both the trailer and the tractor fifth wheel slider plates need to be coated with the Teflon.

Efficiency/Impact: While there will always be some exposure especially at the times the covers are removed for making the connections and the moving of the trailers, this method should minimize the adverse impact that the practice has on the storm water run-

Industrial Stormwater Best Management Practices

off.

BMP 26 Fueling and Liquid Loading/Unloading Operations

Activity: Fueling operations performed by employees on-site or through restricted access systems such as Cardlock sites in various locals across the State.

Typical Pollutants: Gasoline and diesel fuels (Petroleum Hydrocarbon)

Typical Problem: Fueling nozzles can stick in the open or on position when fueling vehicles. Loading/unloading hoses can leak or become disconnected. Employees some times are not instructed in the correct methods for spill clean-up. Frequently, spill clean-up materials are not available at the dispensing pumps Or the loading areas. Fueling stations may not have roofed areas or properly sloped or contained areas for collecting spilled fuel. All of these situations and conditions can result in fuel or other liquids contacting storm water and entering the site runoff.



Cover



Berm

BMP: The fueling area should be designed and operated to minimize contact between spilled fuel, leaked fluids, and storm water. This can be accomplished through roofing the dispensing/loading/unloading area and providing an impervious berm to keep the surface runoff outside the liquid dispensing/loading/unloading areas.

- Use a damp cloth on the pumps and a damp mop on the pavement for area clean up.
- Clean up spills immediately:
 - Spread absorbent material and sweep it up with a broom.

Industrial Stormwater Best Management Practices

- Perform a hazardous waste determination on the absorbed material.
- Dispose of the absorbed material properly.
- Ensure that the overfill nozzle protection is in working order.
- Do not try to top off tanks. Stop filling when the dispensing nozzle shuts off the first time.
- Remove any nozzle locking mechanism which allows the fuel to stay on with the operator absent. The operator should be present at all times to ensure that overfilling and spillage does not occur.
- Cover fueling areas and berm/slope the pavement under the roof to a drain system that is connected to a holding tank or contains the spillage at the surface for easy clean up.
- Provide an easily accessible and well-marked emergency shutoff for pumps with plainly written instructions on how to operate the shutoff.
- Never hose down the fueling area.
- Don't drain spills to the sanitary or the storm water sewers.
- Ensure that the fueling area has an undamaged continuous paved or otherwise impervious surface.
- Ensure that spill cleanup materials are readily available.
- For areas where multiple customers or operators from multiple companies have access, provide highly visible, simple instructions on how to clean up spills and report the incidence.
- Provide well placed, understandable instructions on the proper procedures to follow in the event of an emergency, including reporting information.

Efficiency/Impact: Implementation of this BMP can virtually eliminate this potential source of storm water contamination provided site inspection is frequently performed.

BMP 27 Parking Lots and Yards



Activity: Using gravel areas that do not have a geotextile underlay for vehicle storage, parking or other industrial usage.

Typical Pollutants: Total Suspended Solids, (TSS) turbidity, metals, oil, and other pollutants which attach to soil particles.

Industrial Stormwater Best Management Practices

Typical Problem: Vehicle wheels push the gravel into the underlying soil and pumps the fine soils up through the gravel.

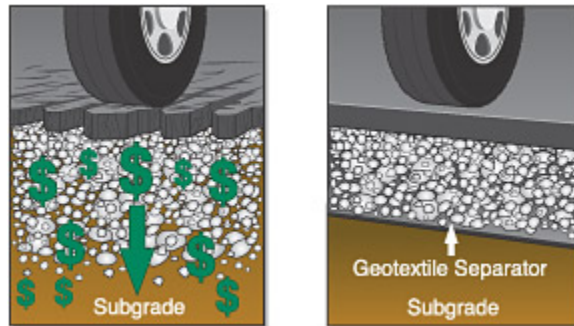

BMP: Remove some of the gravel, place geotextile fabric, and reapply clean gravel on top. This will allow water to migrate through but provide a barrier to gravel soil movement.



Efficiency/Impact: Use of geotextiles to separate soil and rock in roadbeds and in parking lots greatly reduces the amount of soil available to migrate off site in the stormwater runoff. There is a much less expensive method than either asphalt or concrete paving to reduce the sediment and turbidity in the stormwater runoff. The use of these fabrics will normally reduce the level of soil in the runoff to below permitted levels

BMP 28 Stormwater Diversion - Speed Bumps and Speed Humps

Activity: Diverting runoff from sensitive areas or diverting it to an area where it can be treated or controlled

Typical Pollutants: Fertilizers, fuel, alcohol, granular products, just about any type of chemical, TSS, and etc.

Typical Problem: Either stormwater runs into an area that you do not want it to go and becomes contaminated or a product migrates into the stormwater runoff.

Industrial Stormwater Best Management Practices

BMP: Install an asphalt or a concrete or a temporary removable berm to either retain the product or divert the stormwater. In areas where the berm (width and height are approximately the same) would cause problems due to its height and short width, extend the width and make it into a hump (width is typically six or more times the height). The hump would work well where tractor trailer or lift truck operations occur. Humps are presently used in some cities to cause vehicle to slow down without the ability to cause major damage to the vehicles when crossed at reasonable speeds.



Efficiency/Impact: Implementing this control will greatly reduce or illuminate the mixing of pollutants from the mixing and can greatly facilitate the treatment of the runoff by keeping the volume of the runoff that needs to be treated to a minimum.

BMP 29 Grassy Filter Strip and Planter

Activity: Sites with surface water runoff contamination that have implemented specific non-point source BMPs for pollution prevention but have been unable to reduce the pollutant discharges in their storm water runoff to levels below the benchmarks. Unused excess land may be necessary to implement these BMPs.

Typical Pollutants: Sediment (TSS), PAH, metals, BOD, phosphorus, and hydrocarbons (Oil & Grease)

Typical Problem: When the implementation of specific point source BMPs has not eliminated or reduced the contaminants in the storm water to the specific benchmarks, end of the pipe or final discharge BMPs may be necessary.



Industrial Stormwater Best Management Practices

BMP: Install a grassy filter strip and ensure that the storm water passes through the strip in sheet flow. Vegetated filter (buffer) strips are best used on sites with sheet runoff, such as parking lots.

- Effective filter strip widths range from a minimum of 50 feet to a maximum of 200 feet.
- Best for smaller drainage basins, five acres or less.
- Not suitable on slopes or sites with shallow depth to bedrock .
- Best for sheet flow. Do not use on slopes over 10%.
- Good for conventional pollutants.
- Cannot be used to convey larger storms, or concentrated flow discharges as their effectiveness will be destroyed plus they could become sources of pollution through erosion.
- Best grasses are tall fescue, followed by western wheatgrass, annual or Italian Ryegrass, Kentucky Bluegrass.
- Rectangular and V shaped cross sections are the least desirable.
- Design to create a low velocity flow, bent grass is not as good a filter.
- Curbing for impervious areas draining to the filter strips should have a one-foot gap every five feet.



Efficiency/Impact: Properly sized and maintained vegetated filter strips can have a removal efficiency of up to 80 percent for suspended solids.

The graph on the right shows for different simulated rainfall events of a specific intensity and various durations of 30 to 180 minutes, the effect vegetation cover has on the retention and removal of sediment from a site with a 10 % slope.

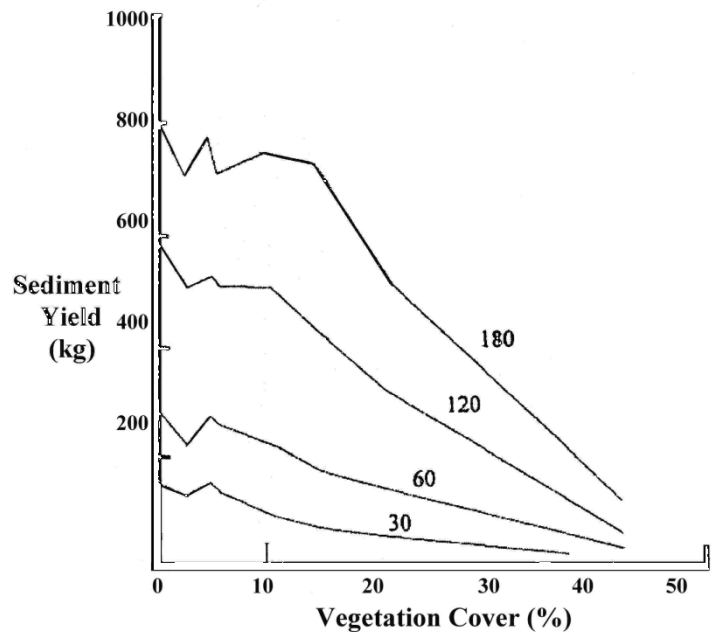

Industrial Stormwater Best Management Practices

BMP 30 Catch Basin Insert Bag

Activity: Sites with surface water runoff contamination that have implemented specific non-point source BMPs for pollution prevention but have been unable to reduce the pollutant discharges in their storm water runoff to levels below the benchmarks. Unused excess land may be necessary to implement these BMPs.



Typical Pollutants: Sediment (TSS), PAH, metals, BOD, phosphorus, and hydrocarbons (Oil & Grease)

Typical Problem: When the implementation of specific point source BMPs has not eliminated or reduced the contaminants in the storm water to the specific benchmarks, end of the pipe or final discharge BMPs may be necessary.

BMP: Install a catch basin filter system (**normal flow**) without overflow slots in the filter media: a catch basin coupled with a sump and sediment traps (i.e. trapped or Lynch style catch basins). May also be used with an inlet device, prefiltering insert and screens (see other facilities and retrofit). The inserts consist of several filtering trays suspended from the inlet grate. Common filters are charcoal, wood fibers or fiberglass.

- Retains small particles, partially effective with high levels of particulate heavy metals, oil/grease, and TSS. Moderate reduction in TSS and turbidity. However, few pollutants are associated with these coarser solids.
- Disadvantage: When 60% full, the suspended solid deposition is in equilibrium with scour, and the capture efficiency is reduced to zero.
- Best in small basins and with treatment of highly turbid runoff prior to discharge to catch basin.
- Do not use on unstable or steep slopes.
- Usually used with vaults, tanks, sumps or inverted (hood) inlet. Inlet can be coupled with a filtration system (see retrofit).
- Maintenance is critical and must be at least semiannual. Require a maintenance schedule and plan for disposal of material removed by the catch basin.
- Insert maintenance is required quarterly and should be inspected more frequently during wet periods.
- Catch basins with a restrictor device (multiple orifice and weir/riser section) for controlling outflow provide minimal control for floatables and petroleum based products.
- Design the size of catch basin sump to handle the site runoff rate, TSS concentration in runoff and how often it will be cleaned out.
- To minimize groundwater pollution problems, be careful where infiltrating catch basins are used (residential areas) and pre-treat the infiltration water.
- **Using a Catch Basin Insert Filter Bag with a bypass or overflow is not recommended as they tend to bypass the inflow almost all of the time. Even during a relatively small rainfall event the types of catch basin insert bags with an overflow or bypass will tend to bypass on trapped (Lynch) type catch basins a significant amount of the runoff**

Industrial Stormwater Best Management Practices

thereby eliminating the benefits of using this BMP. Using an insert bag without an overflow or bypass may result in flow back up and cause temporary local flooding unless the bag has the largest surface area (filtering area) inside of the bag possible for the size of the catch basin in which it is used.

Efficiency/Impact: Catch Basin Filter System Efficiency: TSS up to 22%, and Turbidity up to 38%

BMP 31 Constructed Wetlands

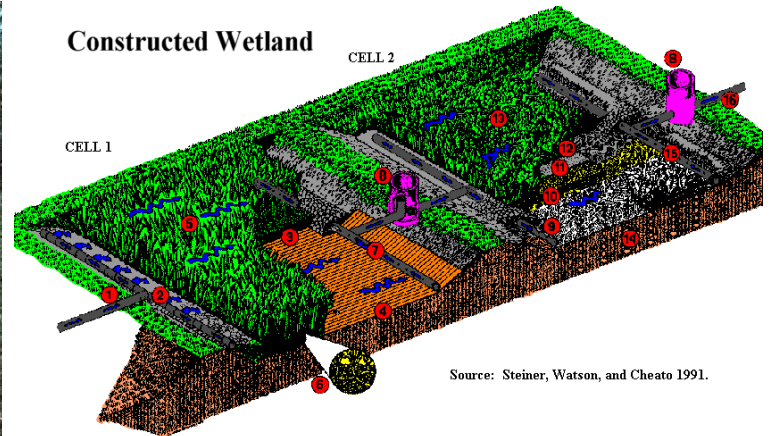

See the Biofilters document at <http://www.deq.state.or.us/wq/stormwater/docs/nwr/biofilters.pdf> for further information on Constructed Wetlands.

Activity: Sites with surface water runoff contamination that have implemented specific non-point source BMPs for pollution prevention but have been unable to reduce the pollutant discharges in their storm water runoff to levels below the benchmarks. Unused excess land may be necessary to implement these BMPs.

Typical Pollutants: Sediment (TSS), PAH, metals, BOD, phosphorus, and hydrocarbons (Oil & Grease)

Typical Problem: When the implementation of specific point source BMPs has not eliminated or reduced the contaminants in the storm water to the specific benchmarks, end of the pipe or final discharge BMPs may be necessary.

BMP: Install a constructed wetland. Constructed wetlands are constructed by a combination of excavation and/or berming. The basic types of constructed wetlands are: shallow marsh, a 2 or 3 celled pond/marsh, extended-detention wetland and pocket wetland.

Storm water treatment facilities are not considered waters of the State, however, their discharge is regulated in the same way as any treatment system. Created wetlands built as mitigation for loss of wetlands under the Clean Water Act Section 404, are considered waters of the State. Created wetlands are protected as natural wetlands and cannot be used for conveyance or treatment of wastewater, unlike constructed wetlands.

- Extended-detention wetland and pocket wetlands are less effective in removal of some types

Industrial Stormwater Best Management Practices

of pollution than other types of wetlands.

- The constructed wetland should be lined when located over permeable soils for permanent pool maintenance. This is to prevent potential groundwater and soil contamination. Use a Bentonite clay (12" thick) or commercial heavy plastic pond liner (minimum 40 ml). Place a minimum of 18" thick compacted soil over the liner prior to seeding.
- The permanent pool depth should be between three to six feet in depth, plus one foot of dead storage for sediment. Six feet is the maximum depth or the pond will stratify in summer and create low oxygen conditions which result in the re-release of phosphorus and other pollutants. In addition, if the pond is deeper than six feet, it will likely pollute the groundwater.
- Suitable for larger sites up to 100 acres.
- Soils should be tested to determine suitability. Best when located in clay loams, silty clay loams, sandy clays, silty clays and clays.
- Cannot be used in areas with shallow depth to bedrock or unstable slopes.
- Good for removal of nutrients and conventional pollutants such as oil and grease and some heavy metals.
- Needs to have a shallow marsh system in association to deal with nutrients.
- Should be multi-celled, preferably three of equal sizes. The first cell should be three feet deep to trap coarse sediments and slow turbulence. They need to be designed as a flow through facility, and the pond bottom should be flat to facilitate sedimentation.
- Need to be designed with periodic maintenance in mind by using an overhead scooping device.
- Side slopes should be 2:1, not steeper than 3:1, and 10 to 20 feet in width. A length to width ratio of 5:1 is preferred, with a minimum ratio of 2:1 to enhance water quality benefits. The longer length allows more travel time and opportunity for infiltration, biofiltration and sedimentation.
- Pond berm embankments over six feet should be designed by a registered engineer. Berm tops should be 15 feet wide for maintenance access and should be fenced for public safety.
- Shape should be long, narrow, and irregular since these are less prone to short circuiting, are more effective, and maximize the treatment area.
- Baffles can be used to increase the flow path and water residence time.
- Should have an overflow system/emergency spillway to accommodate a 100 year, 24 hour flood and a gravity drain.
- Maintenance is of primary importance. The site must be responsibly selected. A maintenance plan needs to address removal of dead vegetation (that release nutrients) prior to the winter wet season, debris removal from trash racks, sediment monitoring in forbays and in basin are likely to contain significant amounts of heavy metals and organics (regular testing is advised).
- Access to the wet pond is to be restricted with a gate and posted signs.
- For mosquito control, either stock the pond with fish or allow it to be drained for short periods of time (do not kill the marsh vegetation).
- Constructed wetland is more complex, with more vegetation, and shallower with greater surface area, hydrologic factors (flow) play a larger part in siting.
- Selection of vegetation should be done by a wetland specialist.
- Oil/water separators can be used prior to the constructed wetland, depending upon the surrounding land uses.
- Relatively low maintenance costs.
- Fence off for safety (children), to protect plants/wildlife.

Industrial Stormwater Best Management Practices

- Disadvantages/constructed wetlands:
 - a.) Constructed wetlands have a larger land requirement for equivalent service compared to a wet pond.
 - b.) Relatively high construction costs.
 - c.) Delayed efficiency until plants are well established (1–2 seasons).
- Buffer width 25 to 50 feet.
- Limit water level fluctuations, as they kill plants.

Efficiency/Impact: Wet pond/wetland removal efficiencies:*

- a) Heavy metals = 40 to 80%;
- b) Total Phosphorus = 40 to 80%
- c) Total Nitrogen = 40 to 60%
- d) TSS = 70%
- e) Soluble reactive phosphorus 75%
- f) Nitrate = 65%
- g) Ammonia = -43
- h) COD = 2
- i) Total copper, lead and zinc = 80 to 95%

* Higher efficiencies are associated with use of O/G trap, larger pond/marsh area and volume. These efficiencies assume that the intensity of the storm water inflow does not exceed the capacity of the wetlands and that the pollutants are not in a concentrated form from a large spill or discharge.

BMP 32 Bioswales



See the **Biofilters** document at

<http://www.deq.state.or.us/wq/stormwater/docs/nwr/biofilters.pdf> for further information on Bioswales.

Activity: Sites with surface water runoff contamination that have implemented specific non-point source BMPs for pollution prevention but have been unable to reduce the pollutant discharges in their storm water runoff to levels below the benchmarks. Unused excess land may be necessary to implement these BMPs.

Typical Pollutants: Sediment (TSS), PAH, metals, BOD, phosphorus, and hydrocarbons (Oil & Grease)

Industrial Stormwater Best Management Practices

Typical Problem: When the implementation of specific point source BMPs has not eliminated or reduced the contaminants in the storm water to the specific benchmarks, end of the pipe or final discharge BMPs may be necessary.

BMP: Install a grassy bioswale. Swales basically act as filters for runoff from frequent storms. The principle form of treatment is the settling out of pollutants and the use of vegetation to take up the dissolved fraction. For best results a swale should be designed to deal with the peak runoff for a two year, 24 hour storm event.

- Does well with first flush runoff, economically feasible, improves aesthetics and has minimal environmental impacts. Best in median strips and parking lot islands.
- The organic topsoil layer is good for degrading petroleum solvents, heavy metals, nutrients and hydrocarbons.
- Critical design elements: size of drainage area to be treated, location of bioretention areas, sizing guidelines, calculate water budget.
- Biofiltration is suitable for smaller sites 10 or less acres.
- Needs a minimum width of 20 feet.
- Must be graded to create sheet flow, not a concentrated stream. Sheet flow decreases the chance of producing gully erosion and distributes contaminants over a wider area. Level spreaders (i.e. slotted curbs) can be used to facilitate sheet flow.
- Can be placed anywhere with careful site design.
- Do not use on steep, unstable slopes or landslides.
- Can reduce peak flow rates.
- Best when used for treatment and conveyance of storm water after a settling pond.
- Good for nutrient removal and conventional pollutants such as suspended solids and some heavy metals.
- Best at 200 feet in length, in tight spaces obtain more length by using a curved path. Should have a maximum bottom width of 50 feet. One foot high check dams should be installed every 50 feet starting 20 feet downstream from the inflow point.
- Good when used at a storm water outfall, commercial development or roadside.

Efficiency/Impact: Bioswales can, when sized correctly and when incorporated with an upstream settling pond, provide similar pollutant removal efficiencies to those achieved by a biopond or constructed wetland.

Removal efficiencies:	a) TSS = 83 to 92%
	b) Lead = 67%
	c) Copper = 46%
	d) Total phosphorus = 29 to 80%
	e) Total zinc and aluminum = 63%
	g) Oil/grease/TPH = 75%
	h) Nitrate-N = 39 to 89%

Industrial Stormwater Best Management Practices

BMP 33 Sand Filters

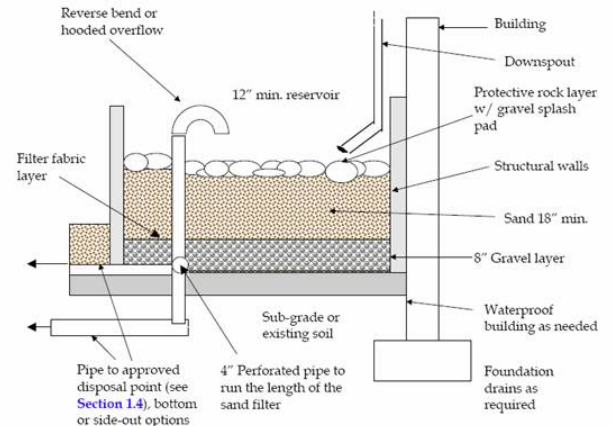

Activity: Sites with surface water runoff contamination that have implemented specific non-point source BMPs for pollution prevention but have been unable to reduce the pollutant discharges in their storm water runoff to levels below the benchmarks.

Typical Pollutants: Total Phosphorus, Heavy Metals, Bacteria, Total Nitrogen

Typical Problem: When the implementation of specific point source BMPs has not eliminated or reduced the contaminants in the storm water to the specific benchmarks, end of the pipe or final discharge BMPs may be necessary.

BMP: Installation of a sand filter has shown to reduce some heavy metals.

Efficiency/Impact: Research has shown zinc to be reduced to as little as 8% of the original concentration. More research is needed to determine the effect a sand filter will have on other metals. The mechanism for the removal of the metals is not completely understood at this time. Due to the particle size, this method should have negligible effect on the dissolved metals.

Typical Pollutant Removal Efficiency

Pollutant	Percent Removal	Pollutant	Percent Removal
Biochemical Oxygen Demand (BOD)	70	Total Kjeldahl Nitrogen (TKN)	46
Total Suspended Solids (TSS)	70	Total Phosphorus (TP)	33 - 85
Total Organic Carbon (TOC)	48	Iron (Fe)	45
Total Nitrogen (TN)	21-47	Lead (Pb)	45
Zinc (Zn)	45	Bacteria	55

Industrial Stormwater Best Management Practices

BMP 34 Porous Pavers

Activity: Areas of a site in which uncontaminated runoff is occurring, the likelihood of chemical or fine particle spill is minimal, and the underlying soils have a capacity to infiltrate. This should also generally be an area of no or low weight vehicle traffic, i.e. sidewalks, passenger automobile parking or traffic areas.

Typical Pollutants: Oil & Grease, small quantities of biodegradable chemicals

Typical Problem: Fairly clean runoff is mixing with contaminated runoff such that the combined volume of runoff is expensive to treat or there is a desire to recharge the shallow subsurface aquifer rather than constructing additional drainage structures or systems.



BMP: Use pavers, porous concrete, and in some cases porous asphalt to provide drainage, surcharge of the shallow aquifer, and a reduction in the stormwater runoff.

Efficiency/Impact: Small amounts of petroleum contamination will be treated by the biota in the shallow soils beneath the porous material. If sediment is present refreshing the porosity can be challenging unless removable pavers are used. In the case of the use of porous asphalt it is unknown as to whether or not the asphalt can be renewed as it is doubtful that a sealcoat can be applied to extend the life of the material as can be done for standard parking lots or roads. If the porous material is properly designed and installed there is the ability to drain fairly large areas in western Oregon during the rainy season and thus reduce or eliminating storm water runoff. This BMP should not be used in areas that have a likelihood of spills or sediment loading.

BMP 35 Flocculation



Activity: Sites with surface water runoff contamination that have implemented specific non-point source BMPs for pollution prevention but have been unable to reduce the pollutant discharges in their storm water runoff to levels below the benchmarks. Unused excess land may be necessary to implement these BMPs.

Industrial Stormwater Best Management Practices

Typical Pollutants: Sediment (TSS), PAH, metals, BOD, phosphorus, and hydrocarbons (Oil & Grease)

Typical Problem: When implementation of specific point source BMPs have not managed or eliminated the contaminants in the storm water to the benchmarks or below or where potential point sources for the contaminants cannot be identified, end of the pipe or final discharge BMPs may be necessary.

BMP: Install a flocculation system using a flocculent such as Chitosan, Calgon Cat Flocc 2953, or a Polyaluminum Chloride such as Sumalchlor-50 or other.

Fine particles suspended in water give it a milky appearance, usually measured as turbidity. Their small size, often much less than 0.001 mm in diameter, give them a very large surface area relative to their volume compared to Total Suspended Solids particles that are in the range of 0.0015 mm in size and larger. These fine particles typically carry a negative surface charge. Largely because of these two factors, small size and negative charge, these particles tend to stay in suspension for extended periods of time. Because of this, removal is not practical by settling alone. Polymers and inorganic chemicals speed the process of clarification. The added chemical destabilizes the suspension and causes the smaller particles to agglomerate. The process consists of three steps: coagulation, flocculation, and settling or clarification.

The conditions under which clarification is achieved can affect performance.

Currents can reduce settling efficiency. Currents can be produced by wind, by differences between the temperature of the incoming water and the water in the clarifier, and by flow conditions near the inlets and outlets. Calm water such as that which occurs during batch clarification provides a good environment for effective performance, as many of these factors become less important in comparison to flow-through clarification basins. One source of currents that is likely important in batch systems is movement of the water leaving the clarifier unit. Given that flocs are relatively small and light the exit velocity of the water must be as low as possible. Sediment on the bottom of the basin can be resuspended and removed by fairly modest velocities.

Coagulants and flocculant-aids:

Polymers are large organic molecules that are made up of subunits linked together in a chain-like structure. Polymers that carry groups with positive charges are called cationic. Cationic polymers can be used as primary coagulants to destabilize negatively-charged turbidity particles present in storm water. Inorganic chemicals such as aluminum or ferric sulfate and aluminum or ferric chloride can also be used, as these chemi-

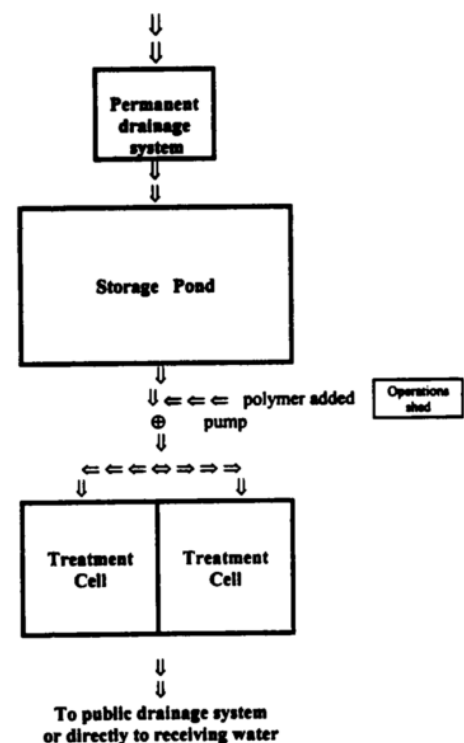

Industrial Stormwater Best Management Practices

cals become positively charged when dispersed in water.

In practice, the only way to determine whether a polymer is effective for a specific application is to perform preliminary or on-site testing. Polymer effectiveness can degrade with time and also from other influences. Thus, manufacturers' recommendations for storage should be followed.

Application of coagulants and flocculant-aids at the appropriate concentration or dosage rate for optimum turbidity removal is important for management of chemical cost, as well as for effective performance. The optimum dose in a given application depends on several site-specific features. The turbidity of untreated water is a primary determinant. The surface charge of particles to be removed is also important, as previously noted. Environmental factors that can influence dosage rate are water temperature, pH, and the presence of constituents that consume or otherwise affect polymer effectiveness (for example, color, oils). Preparation of working solutions and thorough dispersal of polymers in water to be treated is also important to establish the appropriate dosage rate.

Design engineers wishing to review more detailed presentations on this subject are referred to the following textbooks:

- Fair, G., J. Geyer and D. Okun, *Water and Wastewater Engineering*, Wiley and Sons, NY, 1968.
- American Water Works Association, *Water Quality and Treatment*, McGraw-Hill, NY, 1990.
- Weber, W.J., *Physicochemical Processes for Water Quality Control*, Wiley and Sons, NY, 1972.

Comparisons

The above discussion indicates that the design and operation of a polymer system should take into consideration the factors that determine optimum, cost-effective performance. It may not be possible to fully incorporate all of the classic concepts into the design because of practical limitations at construction sites. Nonetheless it is important to recognize the following:

- The right polymer must be used at the right dosage. A dosage that is either too low or too high will not produce the lowest turbidity. There is an optimum dosage rate. This is a situation where the adage "more is always better" does not apply.
- The coagulant must be mixed rapidly into the water to ensure proper dispersion.
- A flocculation step is important to increase the rate of settling, to produce the lowest turbidity and to keep the dosage rate as low as possible.
- Too little energy input into the water during the flocculation stage results in flocs that are too small and/or insufficiently dense. Too much energy can rapidly destroy floc as it is formed.
- Since the volume of the basin is a determinant in the amount of energy per unit volume, a basin can be too big relative to the size of the energy input system.
- Care must be taken in the design of the withdrawal system to minimize outflow velocities.

Number and volume of treatment cells

There are three reasons for having two rather than one treatment cell. First, if something goes wrong with the treatment of a particular batch, the contractor can continue treatment in the second cell. Oregon Department of Environmental Quality

Industrial Stormwater Best Management Practices

cond cell while dealing with the problem in the first cell. The second reason is the uncertainty over the time required to achieve satisfactory clarification. If one had confidence that satisfactory settling could be achieved consistently within 30 to 60 minutes, it might be reasonable to conclude that only one cell is needed since turnover could occur rapidly. The third reason is the time to empty the cell after treatment. It therefore seems appropriate to use two cells.

The second consideration is the volume of the individual treatment cell. There are two opposing considerations in sizing the treatment cells. There is a desire to have a large cell- so as to be able to treat a large volume of water each time a batch is processed. However, the larger the cell the longer the time required to empty the cell. It is also possible that the larger the cell the less effective the flocculation process, and therefore the settling. The simplest approach to sizing the treatment cell is to multiply the allowable discharge rate by the desired draw-down time. The desired draw-down time is about four hours.

A four-hour draw-down time allows one batch per cell per eight hour work period. A batch can be prepared in the morning including an hour or so of flocculation followed by about two hours of settling followed by discharge, although discharge could occur after hours. Or a batch can be prepared in the afternoon, followed by settling overnight, with discharge the following morning. The main point is that it appears to be most logical to size the cell to fit the desired drawdown time, constrained by the allowable release rate.

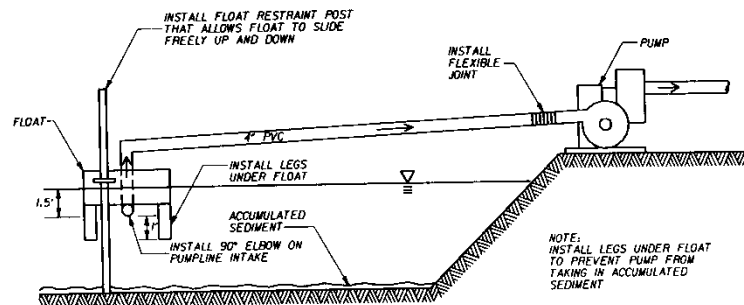

FLOATING PUMPLINE INTAKE (TYP.)

Configuration of the outlet device

The withdrawal device used for removing the liquid from the settling pond should be designed so that pulling settled sediments from the bottom of the treatment cell in the vicinity of the device does not occur. Whether this is a problem is not known but it should be evaluated. One approach is to place the discharge outlet near the area where treated water enters the cell. At this location there will be relatively little accumulation of solid because of the turbulence created by the incoming water.

A second approach is to use the float configuration as in the diagram shown above. The use of four rather than one inlet pipe reduces the inlet velocity. Reduced inlet velocity reduces the possibility that sediments will be picked up and discharged from the settling pond.

A third approach is to modify the float to include a square circular weir that the water enters before reaching the outlet pipe. A circular weir with, say, 10 feet of circumference would significantly reduce the overflow rates (velocity) over the weir. As an example, examine how exit ve-

Industrial Stormwater Best Management Practices

locities are kept as low as possible in water and wastewater clarifiers. These clarifiers include what is known as effluent launders. They are long troughs, placed at the outlet end the clarifier or around the outside circumference in the case of circular clarifiers, into which the water flows. Actually weirs, they reduce the exit velocity of the water leaving the clarification area of the clarifier.

The weir may provide at least one and possibly two benefits with the treatment of storm water. First, it may reduce the carry-out of floc that is still settling while the cell is being drawn down, could result in lower final effluent turbidities and/or allow a reduction in the settling time to achieve the same effluent turbidity. Secondly, the weir could reduce if not eliminate the tendency for the withdrawal pipe to suck-up previously settled sediment.

FLOCCULATION SYSTEMS SHOULD BE DESIGNED BY KNOWLEDGEABLE PERSONNEL. A CONSULTANT SHOULD BE CONTRACTED WITH TO DEVELOP AND IMPLEMENT A SYSTEM. OPERATING PERSONNEL NEED TO BE SPECIFICALLY TRAINED TO OPERATE THESE SYSTEMS.

Chitosan

A product made from shrimp and crab shells called Chitosan has started to be used in Oregon. This material comes in two forms, the semi liquid and a semisolid. Chitosan in the solid form is available in a sock that can be mounted inside of a pipe. This sock form would be released based upon the flow of water around it and does not require the injection and monitoring equipment that other flocculation systems require.



The picture on the left shows a Chitosan sock.

In the picture on the right a sample of turbid water is shown after the Chitosan solid has been lightly dipped and stirred in the sample and left for approximately 10 minutes. The flocculated sediment can be seen forming in the bottom of the jar.

Efficiency/Impact: Mean turbidity reductions can be achieved in the 95.5% to 99.4% range. Metals and other pollutants may be treated with removal efficiencies of 35 to 99 %.

BMP 36 Electrocoagulation

Activity: Sites with surface water runoff contamination that have implemented specific non-point source BMPs for pollution prevention but have been unable to reduce the pollutant dis-

Oregon Department of Environmental Quality

Industrial Stormwater Best Management Practices

charges in their storm water runoff to levels below the benchmarks.

Typical Pollutants: Sediment (TSS), PAH, metals, BOD, phosphorus, and turbidity

Typical Problem: When implementation of specific point source BMPs have not managed or eliminated the contaminants in the storm water to the benchmarks or below or where potential point sources for the contaminants cannot be identified, end of the pipe or final discharge treatment BMPs may be necessary.

BMP: Experiments with a process tentatively called ElectroFloc or Electrocoagulation indicates that it may be possible to use electricity to floc dissolved metals, TSS, turbidity, and other pollutants from storm water runoff. By charging aluminum plates with about 40 volts DC in a batch process, it has been shown to create an approximately equal number of charged particles in suspension. These dissimilar charged particles attract each other and due to aluminum ions present remain in contact with each other in as little as five minutes per liter. This works for TSS and turbidity in the lab and should work for dissolved metals as the metals usually are not really dissolved but submicron in size particles. Dissolved oxygen is increased in the water due to the splitting of the water molecule into hydrogen and oxygen in which the hydrogen leaves the water and the oxygen saturates the water volume. Some commercial package units are available.

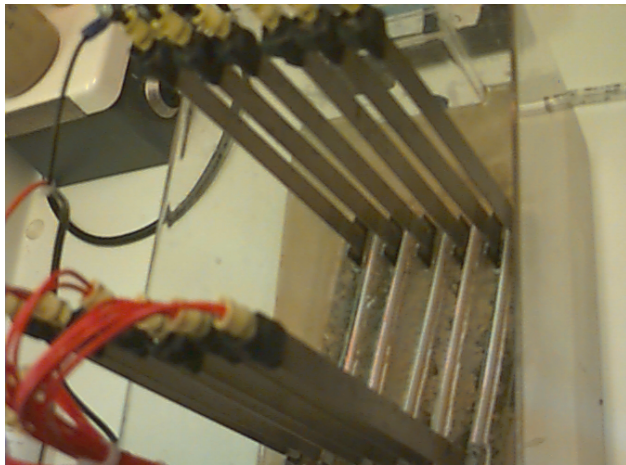

Lab Test Unit showing some floc forming on the surface



Industrial Package Unit

Industrial Stormwater Best Management Practices

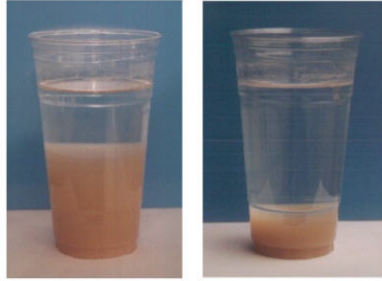

Electro-pulse treatment after 2 minutes of settling time.

Electro-pulse treatment after 3 minute of settling time.

Turbidity from Clay Soils

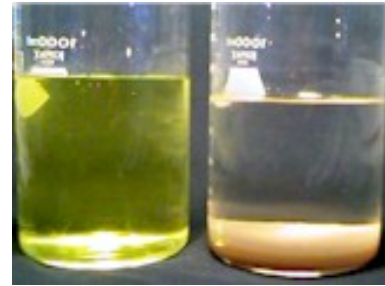

Chromium

Efficiency/Impact:

Lab tests have repeatedly show that TSS and turbidity can be reduced by 98% and the dissolved oxygen content can be increased to around 16 mg/l. The following are various manufacturer's test removal results for the units that they provide:

Arsenic	37 %	Aluminum	75-99.7 %
Barium	94 %	BOD	53-89 %
Calcium	69-98 %	Cadmium	98-99.9 %
COD	65.4-86.2 %	Chromium, Hexavalent	99.9 %
Chromium, Total	97-99.9%	Copper	97-99.9 %
Cyanide	96.1 %	Fluoride	56 %
Iron	95-99 %	Lead	76-98 %
Magnesium	31-74 %	Nickel	90-99.7%
Nitrogen, Total	41.5 %	Oil & Grease	99.5 %
Phosphate	75-97 %	Phosphorus, Total	90.2 %
Radium (pCiL)	98 %	Selenium	44 %
Silicon	84-99 %	Strontium	49 %
Sulfate	33 %	TOC	96-98.6 %
TSS	45.5-99 %	Turbidity	77.8 %
Uranium	96 %	Vanadium	70 %
Zinc	96-99.9%		

References

(Individual manufacturers or suppliers are shown as examples of equipment discussed in this document only and are not specifically recommended by DEQ.)

1. Alfred Kärcher Inc. (1999). *The Kärcher ASA 600 Waste-Water Recycling System*. [On-line]. Available: <http://www.karcher.com>.
2. Botts, J., L. Allard & J. Wheeler. (1998). *Structural Best Management Practices for Storm Water Pollution Control at Industrial Facilities*.
3. Bowler, P. & J. Malek. (1997). *Wetland Restoration/Global Sustainability*. University of California - Irvine.
4. DeLancy, T.A. (1995). *Benefits to Downstream Flood Attenuation and Water Quality as a Result of Constructed Wetlands in Agricultural Landscapes*. American Farmland Trust; Journal of Soil and Water Conservation: <http://www.jswconline.org/content/50/6/620.short>
5. Environmental Best Manufacturing Practices. (1999). *How to be green and stay in the black*. [On-line]. Available: <http://www.bmpcoe.org/library/books/navso%20p-3680/index.html>
6. FloTrend Systems, Inc. (1999). *About Flo Trend Systems, Inc. - Container Filters*. [On-line]. Available: <http://www.flotrend.com/>.
7. Foss Environmental (1998). [On-line]. Available: <http://www.fossenv.com>.
8. Gullywasher (1998). *Catch Basin Inserts* [On-line]. Available: <http://www.gullywasher.com>.
9. Jelen, S.L. & R.C. Sutherland. (1996). *Studies Show Sweeping Has Beneficial Impact on Storm water Quality*. American Public Works Association Reporter; <http://www.apwa.net/Resources/Reporter/>
10. Jelen, S.L., G. Minton & R.C. Sutherland. (1998). *High Efficiency Sweeping as an Alternative to the Use of Wet Vaults for Storm water Treatment, Advances in Modeling the Management of Storm water Impacts*. Vol. 5 & Vol. 6, ISBN 0-9697422-8-2. [On-line]. Available: <http://pacificwr.com/Publications/Chapter18-wetvaults.pdf>
11. Jurries, D. (1997). *Best Available Economical Environmental Practices*. Blackhawk Services.
12. KriStar. (1998). *Fossil Filter*. [On-line]. Available: <http://kristar.com>.
13. Landa Inc. (1999) *North America's largest manufacturer of pressure washers and water cleaning systems*. [On-line]. Available: <http://www.landa-inc.com>
14. Los Alamos National Laboratory Pollution Prevention Program Office. (1998). [On-line]. Available: <http://www.lanl.gov>.

Industrial Stormwater Best Management Practices

15. National Technology Transfer Center. (1999). [On-line]. Available: <http://iridium.nttc.edu>.
16. North Carolina Department of Environment and Natural Resources. (1999). *Division of Water Quality*. [On-line]. Available: <http://portal.ncdenr.org/web/wq/ws/su>
17. Ohio Environmental Protection Agency. (1993). *Extending the Life of Metal Working Fluids*, Ohio EPA Fact Sheet – Number 11. [On-line]. Available: <http://www.P2pays.org/ref/01/00072.htm>.
18. Oregon Association of Clean Water Agencies. (1998). *Municipal Storm water Toolbox for Maintenance Practices*.; <http://www.oracwa.org/pdf/or-municipal-stormwater-toolbox-for-maintenance%20practices.pdf>
19. Oregon Department of Environmental Quality. (1998). *Storm Water Management Guidelines*.
20. Pacific Northwest Pollution Prevention Research Center. (1998). [On-line]. Available: <http://www.pprc.org>
21. Parts Washers and Water Recycling Systems. (1998). [On-line]. Available: <http://www.hotsy.com>
22. Pollution Engineering. (1998). [On-line]. Available: <http://www.pollutioneng.com>.
23. Pollution Online. (1998). [On-line]. Available: <http://www.pollutiononline.com>.
24. Pollution Prevention Management Company. (1996). *Selected Pollution Prevention Techniques for Wastewater Agencies*.; 6327 SW Capitol Highway, Suite 101, Portland, (503)225-1050
25. Ruisinger, T.P. (1996). Ozonation in Cooling Water Systems. *Plant Engineering Magazine*. The Marley Cooling Tower Co.; <http://www.highbeam.com/doc/1G1-18669207.html>;
<http://www.plantengineering.com/magazine.html>
26. Resource Planning Associates/HoweConsult. (1999). *Polymer-Assisted Clarification of Storm water from Construction Sites: Experience in the City of Redmond, Washington*. [On Line] Available: <http://www.regulations.gov/#!documentDetail;D=EPA-HQ-OW-2008-0465-1497>
27. The Scotts Company. (1999). *Lawn care and gardening tips and products for the homeowner and do-it-yourself markets*. <http://www.scotts.com/>
28. The Schwarze EV-series Cleaners. (1999). [On-line]. Available: <http://www.schwarze.com/sweepers/ev>.
29. StormTreat Systems (1999). [On-line]. Available: <http://www.stormtreat.com>
30. Canister Filtration; Contech Engineered Solutions LLC. Available: <http://www.conteches.com/>
31. University of Idaho. (1999). *Best Management Practices for Small, Medium, and Large Lawns in the Pacific Northwest Water Quality Brochure*. [On-line]. Available: <http://www.uidaho.edu/wq/wqbr/wqbr23.html>.

Industrial Stormwater Best Management Practices

32. U.S. Environmental Protection Agency. (1998). *Sector Notebook Reports*. [On-line]. Available: <http://www.epa.gov/>
33. U.S. Environmental Protection Agency - Office of Water (EN-336). (1993). *Guidance Manual for Developing Best Management Practices (BMP)*. EPA 833-B-93-004. USEPA; <http://www.epa.gov/>
34. Stormwater Treatment Northwest. Vol. 6, No.2, July 2000; <http://www.stormwaterbook.com/newsletter.html>
35. Ben R. Urbonas, P. E., Chief, Master Planning Program, “*Sand Filter Design, Hydraulic Design of Sand Filters for Stormwater Quality*”, (1997), [On-line]. Available: http://www.udfed.org/downloads/pdf/tech_papers/Sand-flt-paper.pdf
36. EPA, “*Storm Water Technology Fact Sheet – Sand Filters*”, EPA 832-F-99-007, September 1999, [On-line]. Available: http://water.epa.gov/scitech/wastetech/upload/2002_06_28_mtb_sandfltr.pdf
37. EPA, “*Storm Water Technology Fact Sheet – Water Quality Inlets*”, EPA 832-F-99-029, September 1999, [On-line]. Available: http://water.epa.gov/scitech/wastetech/upload/2007_05_29_mtb_wtrqlty.pdf
38. ChemFree Corporation, “SmartWasher”, [On-line]. Available: <http://www.chemfree.com>
39. Haz-Stor, “Hazardous Storage Buildings”, [On-line]. Available: <http://www.hazstor.com>
40. Hazmat Storage Containers, “Containment Pallets”, [On-line]. Available: <http://www.hazmatstorage.com>
41. Tennant Company, “Sweepers & Scrubbers”, [On-line]. Available: <http://www.tennantco.com>
42. Seeds and Lawns; Hobbs & Hopkins, 1712 SE Ankeny St., Portland, OR 97215, (503) 239-7518, [On-line]. Available: <http://www.protimelawnseed.com/>
43. EPA, “*Storm Water Technology Fact Sheet – Modular Treatment System*”, EPA 832-F-99-044, September 1999, [On-line]. Available: http://water.epa.gov/scitech/wastetech/upload/2002_06_28_mtb_modtreat.pdf
44. CJE Consultants and Contractors, Inc., P.O. Box 65, Turner, OR 97392, (503) 743-2291, “*Flocculation System Summary – West Linn Corporate Park*”, September 30, 1999, e-mail: cje@viser.net.
45. Advanced Environmental Solutions, Inc., “*Containment Pallets & Berms*”, [On-line]. Available: <http://www.advenvironmental.com>.
46. Watershed Protection Techniques, 1(5): 254-264; “*Toward a Low Input Lawn*”; Available: Stormwater Manager's Resource Center; <http://www.stormwatercenter.net>
47. Ecosystems and Water Quality Conference, March 18-21, 1996, U.S. EPA and the Northeastern Planning Commission, Chicago, IL., “*New Critical Source Area Controls in the SLAMM Storm-*

Industrial Stormwater Best Management Practices

water Quality Model”, Robert Pitt, Dept. of Civil Engineering, University of Alabama at Birmingham.

48. Chitosan, HaloSource, Inc.; 1725 220th Street SE Suite 103, Bothell, WA 98021; (425) 861-9499, 425-881-6464; <http://www.halosource.com/index.aspx>
50. Raising the Bar on Construction Storm Water Treatment, Stormwater Magazine, May/June 2004, <http://www.forester.net>
51. UltraTech International Inc., Portable Containment Berm, 800-353-1611, <http://www.spillcontainment.com>
52. Technical and Regulatory Guidance Document for Constructed Wetlands, December 2003, Interstate Technology Regulatory Council (ITRC), <http://www.itrcweb.org/>
53. Sentry Portable Welding Fume Extractor high efficiency HEPA filtration. Sentry Air Systems, Inc. (800) 799-4609, <http://www.sentryair.com>
54. Welding Fume Control; Hawthorne Systems, Inc. (419) 643-5861, <http://www.hawthornesystems.com/index.html>
55. Abanaki Oil Skimmers, Abanaki Corporation Oil Skimmer Division (800) 358-7546, <http://www.abanaki.com/petrox.html>
56. Hydro Engineering, Inc., Portable Wash Rack “*Closed Loop Wash Rack System*”, 800-247-8424, <http://www.hydroblaster.com>
57. Pavement deep cleaning scrubbing system; EnviroClean Seattle Inc. (206) 835-7000
58. Parking Lot Supply, Speed Bumps and Speed Humps, (888)776-2498, www.parkinglotsupply.com
59. EPA - Stormwater Best Management Practices (BMP) Performance Analysis, Tetra Tech, Inc, 2010, <http://www.epa.gov/region1/npdes/stormwater/assets/pdfs/BMP-Performance-Analysis-Report.pdf>
60. The Lawn Institute. [On-line]. Available: <http://www.lawninstitute.com>.
61. University of Idaho. (2003). *Best Management Practices for Small, Medium, and Large Lawns in the Pacific Northwest* Water Quality Brochure. [On-line]. Available: <http://www.uiweb.uidaho.edu/wq/wqbr/wqbr23.html>
62. Upper Susquehanna Coalition (USC) Wetland Program <http://www.u-s-c.org/html/wetlandprogram1.htm>
63. Washington Stormwater Center (1998). [On-line]. Available: <http://www.wastormwatercenter.org/>