

**FIRE CODE / LAND USE / BUILDING REVIEW  
APPLICATION**



**North Operating Center**  
11945 SW 70<sup>th</sup> Avenue  
Tigard, OR 97223  
Phone: 503-649-8577

**South Operating Center**  
8445 SW Elligsen Rd  
Wilsonville, OR 97070  
Phone: 503-649-8577

REV 6-30-20

**Project Information**

Applicant Name: MIG  
Address: 506 SW 6th Avenue, Suite 400, Portland, OR 97204  
Phone: (503) 757-1211  
Email: cbrennecke@migcom.com  
Site Address: None (SW Parkway Road, north of Boeckman Road, adjacent to Interstate 5)  
City: Wilsonville  
Map & Tax Lot #: 31W11 00800  
Business Name: PGE  
Land Use/Building Jurisdiction: Wilsonville  
Land Use/ Building Permit # DB23-0007

Choose from: Beaverton, Tigard, Newberg, Tualatin, North Plains, West Linn, Wilsonville, Sherwood, Rivergrove, Durham, King City, Washington County, Clackamas County, Multnomah County, Yamhill County

**Project Description**

Development of a new PGE electrical substation on an undeveloped lot at SW Parkway Road, north of Boeckman Road, adjacent to Interstate 5 (tax lot 31W11 00800).

**Permit/Review Type (check one):**

- Land Use / Building Review - Service Provider Permit
- Emergency Radio Responder Coverage Install/Test
- LPG Tank (Greater than 2,000 gallons)
- Flammable or Combustible Liquid Tank Installation (Greater than 1,000 gallons)
  - \* Exception: Underground Storage Tanks (UST) are deferred to DEQ for regulation.
- Explosives Blasting (Blasting plan is required)
- Exterior Toxic, Pyrophoric or Corrosive Gas Installation (in excess of 810 cu.ft.)
- Tents or Temporary Membrane Structures (in excess of 10,000 square feet)
- Temporary Haunted House or similar
- OLCC Cannabis Extraction License Review
- Ceremonial Fire or Bonfire (For gathering, ceremony or other assembly)

**For Fire Marshal's Office Use Only**

TVFR Permit # 2023-0106  
Permit Type: SPP - Wilsonville  
Submittal Date: 7/24/2023  
Assigned To: McGladrey  
Due Date: 7/24/2023  
Fees Due: N/A  
Fees Paid: 0

**Approval/Inspection Conditions**  
(For Fire Marshal's Office Use Only)

**This section is for application approval only**

M. J. 7/24/2023  
Fire Marshal or Designee Date

Conditions:

See Attached Conditions:  Yes  No

Site Inspection Required:  Yes  No

**This section used when site inspection is required**

Inspection Comments:

N/A







City of Wilsonville  
Exhibit B1 DB23-0007

Final TVFR Approval Signature & Emp ID Date

SHEET NOTES

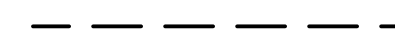
TOTAL LOT AREA = 185,272 SF  
 PROPOSED GRAVEL AREA = 141,808 SF  
 PROPOSED LANDSCAPE AREA = 43,464 SF

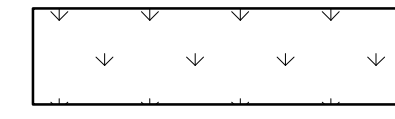
SHEET LEGEND

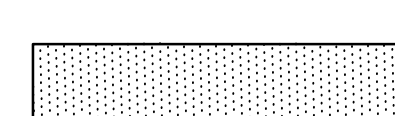
-  PROPERTY LINE
-  EASEMENT LINE
-  PROPOSED FENCE
-  PROPOSED FILTRATION RAIN GARDEN PER COW DETAIL ST-6020
-  PROPOSED GRAVEL SURFACING
-  STANDARD ASPHALT PAVEMENT

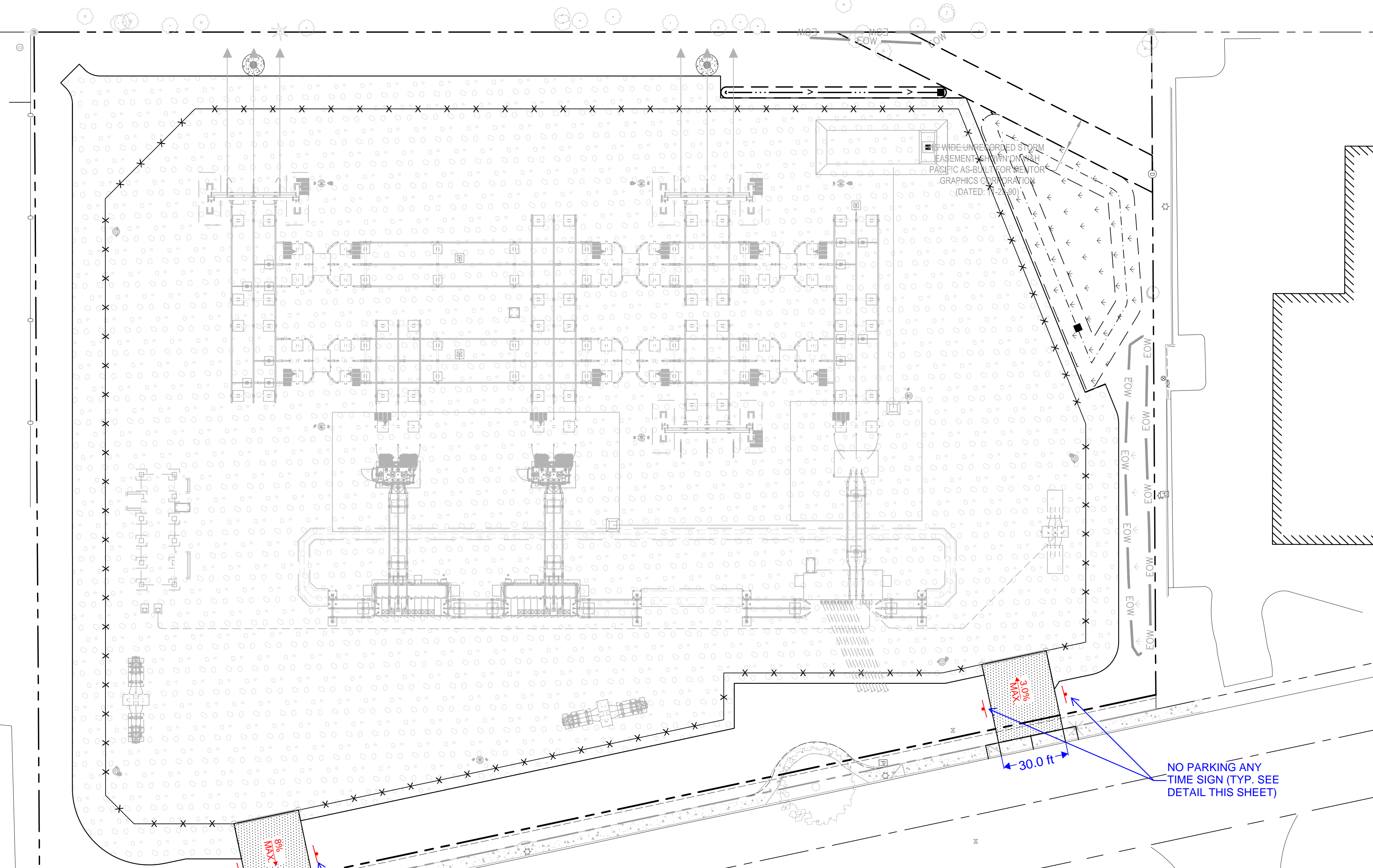
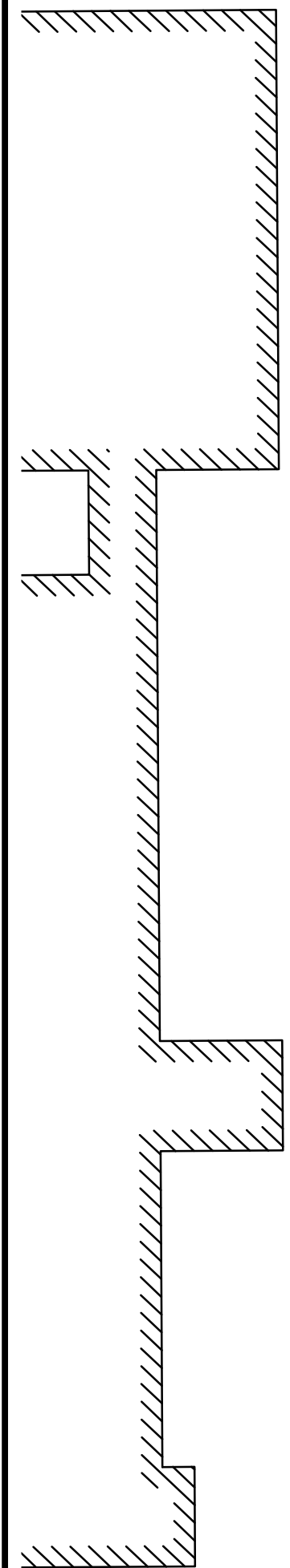

NO PARKING ANY TIME SIGN (TYP. SEE DETAIL THIS SHEET)

NO PARKING ANY TIME SIGN (TYP. SEE DETAIL THIS SHEET)

APPROXIMATE LOCATION OF EXISTING FIRE HYDRANT



TVF&R Permit #2023-0106

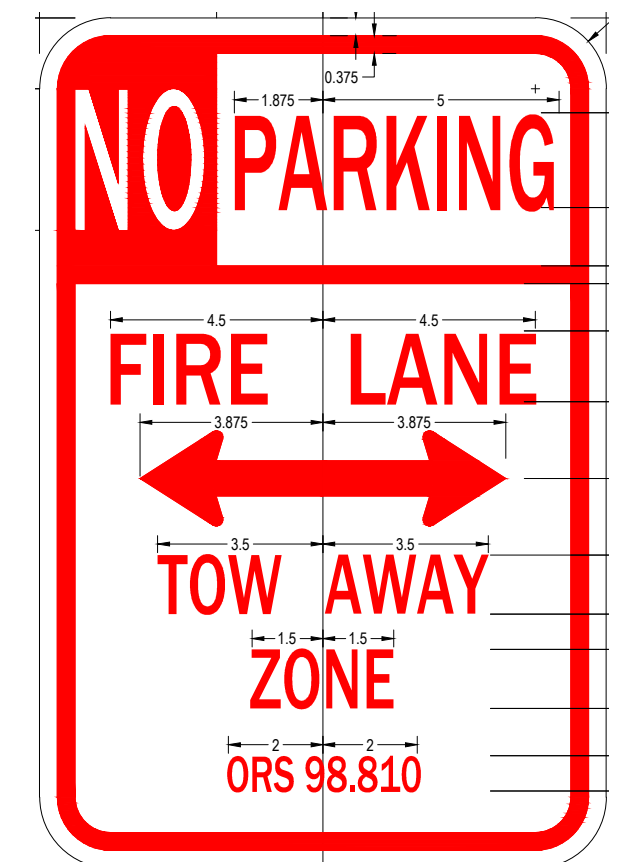

1 NO PARKING SIGNS  
SCALE: NTS

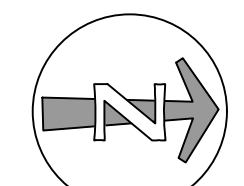
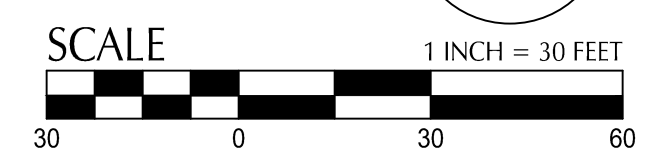

File: \\n:\proj\1\ch\Projects\2022\2204048-PGE-Memorial-Substation\CA\DWG\LOT\U20448-01-SITE-LU.dwg TAB C1  
 Plotted: 7/21/23 at 3:02pm By: lleggat

REVISION	DATE	DESCRIPTION	BY



JOB No.:	2200448
DESIGNED BY:	TL, BC
DRAWN BY:	TL, RC
CHECKED BY:	JL
PLOT DATE:	7/21/23 3:02pm
PLOTTED BY:	lleggat
DWG NAME:	20448-01SITELU.dwg
TAB NAME:	C1



PORTLAND GENERAL ELECTRIC CO. - 121 SW SALMON ST. PORTLAND, OR 97204

MEMORIAL SUBSTATION  
 LANDUSE SUBMITTAL  
 27601 SW PARKWAY AVENUE, WILSONVILLE, OR 97070

FIRE SERVICE PLAN

SHEET NO.  
**FS-1**



**After recording return to:**

Alexander J. Clark  
Miller, Canfield, Paddock and Stone, P.L.C.  
840 W. Long Lake Rd., Suite 150  
Troy, Michigan 48098

**GRANTOR:**

Siemens Industry Software Inc.  
5800 Granite Parkway, Suite 600  
Plano, Texas 75024

**Until a change is requested, all tax statements shall be sent to Grantee at the following address:**

Portland General Electric Company  
121 SW Salmon Street  
Portland, Oregon 97204

**This space reserved for recorder's use.**

Clackamas County Official Records	<b>2021-086801</b>
Sherry Hall, County Clerk	09/24/2021 09:01:01 AM
D-D                      Cnt=1 Stn=75 TIFFANY	<b>\$113.00</b>
\$25.00 \$16.00 \$10.00 \$62.00	

**STATUTORY SPECIAL WARRANTY DEED**

SIEMENS INDUSTRY SOFTWARE INC., a Delaware corporation, and successor by merger to Mentor Graphics Corporation ("Grantor") conveys and specially warrants to PORTLAND GENERAL ELECTRIC COMPANY, an Oregon corporation ("Grantee") the real property in Clackamas County, Oregon, more particularly described on Exhibit A attached hereto and by this reference incorporated herein (the "Property"), free of encumbrances created or suffered by the Grantor, except for those encumbrances set forth on Exhibit B, attached hereto and by this reference incorporated herein.

The true consideration for this conveyance in terms of dollars is \$3,550,000.00.

BEFORE SIGNING OR ACCEPTING THIS INSTRUMENT, THE PERSON TRANSFERRING FEE TITLE SHOULD INQUIRE ABOUT THE PERSON'S RIGHTS, IF ANY, UNDER ORS 195.300, 195.301 AND 195.305 TO 195.336 AND SECTIONS 5 TO 11, CHAPTER 424, OREGON LAWS 2007, SECTIONS 2 TO 9 AND 17, CHAPTER 855, OREGON LAWS 2009, AND SECTIONS 2 TO 7, CHAPTER 8, OREGON LAWS 2010. THIS INSTRUMENT DOES NOT ALLOW USE OF THE PROPERTY DESCRIBED IN THIS INSTRUMENT IN VIOLATION OF APPLICABLE LAND USE LAWS AND REGULATIONS. BEFORE SIGNING OR ACCEPTING THIS INSTRUMENT, THE PERSON ACQUIRING FEE TITLE TO THE PROPERTY SHOULD CHECK WITH THE APPROPRIATE CITY OR COUNTY PLANNING DEPARTMENT TO VERIFY THAT THE UNIT OF LAND BEING TRANSFERRED IS A LAWFULLY ESTABLISHED LOT OR PARCEL, AS DEFINED IN ORS 92.010 OR 215.010, TO VERIFY THE APPROVED USES OF THE LOT OR PARCEL, TO DETERMINE ANY LIMITS ON LAWSUITS AGAINST FARMING OR FOREST PRACTICES, AS DEFINED IN ORS 30.930, AND TO INQUIRE ABOUT THE RIGHTS OF NEIGHBORING PROPERTY OWNERS, IF ANY, UNDER ORS 195.300, 195.301 AND 195.305 TO 195.336 AND SECTIONS 5 TO 11, CHAPTER 424, OREGON LAWS 2007, SECTIONS 2 TO 9 AND 17, CHAPTER 855, OREGON LAWS 2009, AND SECTIONS 2 TO 7, CHAPTER 8, OREGON LAWS 2010.

[Signatures appear on next page(s)]

DATED: September 24, 2021

**Siemens Industry Software Inc.,**  
a Delaware corporation

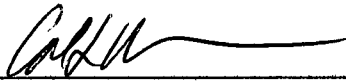
By:   
Name: Anthony L. Hemmelgarn  
Its: President

State of TEXAS )  
County of COLLIN )

On this 21<sup>ST</sup> day of September, 2021, personally appeared before me Anthony L. Hemmelgarn, who being by me duly sworn, did say that he/she is the President of Siemens Industry Software Inc., a Delaware corporation, and that the execution of said instrument on behalf of said corporation was authorized by said corporation through its bylaws and resolutions, and acknowledged to me that said corporation executed the same.

SEAL

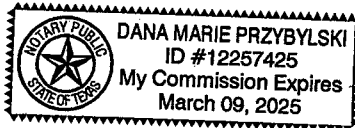

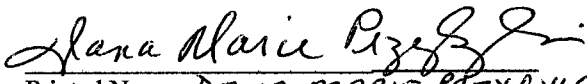
  
Printed Name: DANA MARIE PRZYBYLSKI  
My commission expires: 3-9-2025  
Notary Public, in and for said County and State  
My Commission Expires: 3-9-2025  
Acting in COLLIN County

[Signature page to Statutory Special Warranty Deed]



By: Timo Nentwich  
Name: Timo Nentwich  
Its: Chief Financial Officer

State of TEXAS )

County of COLLIN )

On this 21<sup>ST</sup> day of September, 2021, personally appeared before me Timo Nentwich, who being by me duly sworn, did say that he/she is the Chief Financial Officer of Siemens Industry Software Inc., a Delaware corporation, and that the execution of said instrument on behalf of said corporation was authorized by said corporation through its bylaws and resolutions, and acknowledged to me that said corporation executed the same.

SEAL

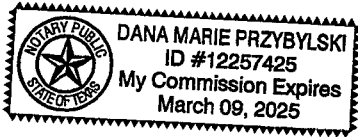

Dana Marie Przybylski  
Printed Name: DANA MARIE PRZYBYLSKI  
My commission expires: 3-9-2025  
Notary Public, in and for said County and State  
My Commission Expires: 3-9-2025  
Acting in COLLIN County

**EXHIBIT A**

**LEGAL DESCRIPTION**

The land situated in the County of Clackamas, State of Oregon, as more particularly described as follows:

PART OF THE EAST ONE -HALF OF THE SOUTHEAST ONE -QUARTER OF SECTION 11, TOWNSHIP 3 SOUTH, RANGE 1 WEST, OF THE WILLAMETTE MERIDIAN, IN THE CITY OF WILSONVILLE, COUNTY OF CLACKAMAS AND STATE OF OREGON, DESCRIBED AS FOLLOWS:

BEGINNING AT A POINT ON THE EAST LINE OF THE WEST PORTLAND-HUBBARD HIGHWAY, INTERSTATE HIGHWAY NO. 5 WITH THE SOUTH LINE OF THE NORTH ONE-HALF OF THE SOUTHEAST ONE-QUARTER OF THE SOUTHEAST ONE - QUARTER OF SECTION 11; THENCE NORTH 0°27'45" EAST ALONG THE EAST LINE OF SAID HIGHWAY A DISTANCE OF 509.8 FEET, MORE OR LESS, TO AN IRON ROD AT THE WEST END OF THE BOUNDARY LINE DESCRIBED IN AN AGREEMENT RECORDED JUNE 21, 1974 AS RECORDER'S FEE NO. 74 17239, FILM RECORDS; THENCE SOUTH 89°55' EAST A DISTANCE OF 308.52 FEET TO AN IRON ROD AT THE EAST END OF SAID BOUNDARY LINE, BEING ON THE WESTERLY LINE OF COUNTY ROAD NO. 217; THENCE SOUTHERLY ALONG THE WESTERLY LINE OF SAID COUNTY ROAD A DISTANCE OF 521 FEET, MORE OR LESS, TO A POINT ON THE SOUTH LINE OF THE NORTH ONE - HALF OF SAID SOUTHEAST ONE - QUARTER OF THE SOUTHEAST ONE - QUARTER; THENCE NORTH 89°55' WEST A DISTANCE OF 418.91 FEET, MORE OR LESS TO THE POINT OF BEGINNING

Property Address: Vacant SW Parkway Avenue, Wilsonville, Oregon  
Tax Parcel Identification Number: 00805196



## **EXHIBIT B**

### **ENCUMBRANCES**

- (a) The lien of all ad valorem real estate taxes and assessments not yet due and payable as of the date hereof;
- (b) Local, state and federal laws, ordinances or governmental regulations, including but not limited to, building and zoning laws, ordinances and regulations, now or hereafter in effect relating to the Property;
- (c) Any and all recorded easements, reservations, restrictions, encroachments, encumbrances, and all other covenants, conditions, agreements, and other items of record that encumber the Property;
- (d) Any matters which would be shown by an inspection, a survey of the real estate described in this deed or by inquiry of persons in possession of the Property;
- (e) The terms and provisions contained in the document entitled "Boundary Line Agreement" recorded June 21, 1974 as Fee No. 74017239 of Official Records;
- (f) Easement, including the terms and provisions contained therein, in favor of the City of Wilsonville, Oregon for street construction and public utilities as recorded June 7, 1988 as Fee No. 88022435 of Official Records; and
- (g) Easement, including the terms and provisions contained therein, in favor of the City of Wilsonville, Oregon for sidewalk purposes as recorded March 7, 2002, as Fee No. 2002 022173 of Official Records.



**Portland General Electric**  
121 SW Salmon Street · Portland, Ore. 97204

**CONDITIONAL USE  
SITE DESIGN REVIEW**

# ***PGE Memorial Substation***

**Submitted to:  
City of Wilsonville  
Planning Department**

**Submitted on Behalf of:  
Portland General Electric Company**

Prepared by:



***Submitted for 3<sup>rd</sup> Completeness: December 4, 2023***



## TABLE OF CONTENTS

<b>I. Proposal Summary Information</b> .....	<b>4</b>
<b>II. Project Team</b> .....	<b>5</b>
<b>III. Project Description and Existing Conditions</b> .....	<b>6</b>
Background .....	6
Site Context.....	7
Requested Approvals .....	7
<b>IV. Conformance with Wilsonville Development Code</b> .....	<b>11</b>
A. PDI Development Standards.....	11
B. Planned Development Standards and Regulations for all Planned Development (PD) Zones.....	17
C. Site Design Review .....	19
D. General Development Regulations .....	26
E. Conditional Use .....	50
F. Underground Utilities.....	51
G. Tree Preservation and Protection .....	52
H. Definition of Terms.....	53
<b>V. Conclusion</b> .....	<b>54</b>

## **EXHIBITS**

### **Exhibit A. Plan Set**

- C.0 Existing Conditions/Survey
- C.1 Site Development Plan
- C.2 Grading and Utility Plan
- L1.1 Landscape Plan
- L1.2 Tree Preservation and Protection Plan
- S1-2 Sign Plans

### **Exhibit B. Land Use Development Application Form**

### **Exhibit C. Deed/ Title Report/Tax Map**

### **Exhibit D. Arborist Report**

### **Exhibit E. Stormwater Report**

### **Exhibit F: Traffic Memo**

### **Exhibit G: Lighting Study, Photometric Plan and Cut Sheets**

### **Exhibit H: Fence Details**

### **Exhibit I: Transmission Routing and Distribution Sheet**

### **Exhibit J: TVF&R Service Provider Letter**

### **Exhibit K: Public Works Construction Standards Waiver Request w/exhibits**



## I. Proposal Summary Information

<b>Applicant:</b>	<b>Portland General Electric</b> Attn: Andrew Yaden, Property Services Specialist 121 SW Salmon Street, 1WTC1302 Portland, Oregon 97204 Phone: 503-329-2693 Email: <a href="mailto:andrew.yaden@pgn.com">andrew.yaden@pgn.com</a>
<b>Applicants Representative:</b>	<b>MIG   APG</b> Attn: Carrie Brennecke, AICP, Senior Planner 506 SW 6 <sup>th</sup> Avenue, Suite 400 Portland, OR 97204 Phone: 503-757-1211 Email: <a href="mailto:cbrennecke@migcom.com">cbrennecke@migcom.com</a>
<b>Owner:</b>	<b>Portland General Electric Company</b> Signatory: Meredith Armstrong, Property Services Manager 121 SW Salmon Street, 1WTC1302 Portland, Oregon 97204 Phone: 503-464-7672
<b>Request:</b>	Conditional Use, Type III Site Design Review, Type II
<b>Location:</b>	SW Parkway Road, north of Boeckman Road, adjacent to Interstate 5
<b>Tax Lot ID:</b>	31W11 00800
<b>Zoning Designation:</b>	Planned Development Industrial (PDI)
<b>Tax Lot Size:</b>	4.32 acres

## II. Project Team

### Owner

Portland General Electric Company  
121 SW Salmon Street  
Portland, Oregon 97204

Meredith Armstrong  
Manager, Property Services,  
503.464.2174  
[Meredith.armstrong@pgn.com](mailto:Meredith.armstrong@pgn.com)

Andrew Yaden  
Associate Specialist, Property Services  
503-329-2693  
[Andrew.yaden@pgn.com](mailto:Andrew.yaden@pgn.com)

Jordan Messinger, PE, SE  
Senior Project Manager  
503-464-8554  
[jordan.messinger@pgn.com](mailto:jordan.messinger@pgn.com)

### Land Use Planner

MIG  
506 SW 6<sup>th</sup> Avenue, Suite 400  
Portland, Oregon 97205

Carrie Brennecke, AICP  
Senior Planner  
503-757-1211  
[cbrennecke@migcom.com](mailto:cbrennecke@migcom.com)

### Engineering

KPFF  
111 SW 5th Ave, Suite 2400  
Portland, OR 97204

Josh Lighthipe  
Senior Project Manager  
503-542-3860  
[Josh.Lighthipe@kpff.com](mailto:Josh.Lighthipe@kpff.com)

### Landscape Architect

NNA Landscape Architecture  
1811 S. River Drive, Suite 300  
Portland, OR 97201

Jane Jewett  
Landscape Architect  
503-239-0600  
[jane@nnala.com](mailto:jane@nnala.com)

### Arborist

Integrated Arboricultural Solutions  
PO Box 68012  
Portland, Oregon 97267

Chris Whitman  
971-335-1414  
[chris@integratedarbsolutions.com](mailto:chris@integratedarbsolutions.com)

### **III. Project Description and Existing Conditions**

#### ***Background***

Portland General Electric Company (PGE) is Oregon’s largest electric utility and has provided electricity to customers in the northern Willamette Valley since 1889. Headquartered in Portland, Oregon, PGE has nearly 125 years of experience in the generation, transmission, and distribution of electricity, supplying power to a population of over 1.9 million people, with approximately 862,000 residential and more than 105,000 commercial customers within a 4,000 square-mile service territory, including 51 Oregon cities.

The Wilsonville region is currently experiencing increases in electrical demand due to continuing residential growth as well as a number of new commercial and industrial facilities with substantial electrical supply needs. Currently, the Wilsonville region is served exclusively by the existing Coffee Creek and Wilsonville substations. No other substations currently exist within a reasonable distance to offset the load at these facilities. Additionally, the existing Wilsonville substation is not a candidate for expansion due to the limited space available at the current site. This has necessitated the development of a new substation to create additional capacity.

This application is to develop the new substation facility and associated site improvements. At construction a single distribution transformer and two transmission sources will be installed which will allow for the sharing of load with the existing substations to allow for their continued use. When the existing Wilsonville substation reaches the end of its service life, a second and third distribution transformer and a third transmission source will be added in the gravel yard of the substation, and the existing Wilsonville substation will be decommissioned. This will allow PGE to provide reliable and cost-effective electricity service to Wilsonville customers now and into the future. Note the entire substation will be developed with this application. Only additional PGE equipment (second and third distribution transformer/switchgear) is proposed to be added at a later date within the developed facility. There is not an approximate timeline for the additional equipment installation. No site expansion or alterations will be required for the installation of the future equipment.

In conjunction with the site improvements for the substation, PGE will also be modifying the routing of a nearby existing transmission line to provide the two transmission sources into the new substation facility, which will be the source of electricity that will be converted into a lower voltage for local electric service.

#### ***Project Summary***

Portland General Electric Company (PGE) is requesting approval of a Type III Conditional Use and Site Design Review, for development of an electrical substation at SW Parkway Road, north of Boeckman Road, adjacent to Interstate 5 (tax lot 31W11 00800).

The site is in the Planned Development Industrial (PDI) zone, shown in Figure 1, Zoning Map. The Memorial Substation is a crucial element of substation improvements across PGE’s network and is needed to provide PGE’s service to the growing region. The population and employment

base in the region and its surrounding communities have grown significantly in recent years. The development of the substation is necessary to add capacity to the power delivery system, increase system reliability, meet the demands of growth, and continue to provide reliable and safe power to serve Wilsonville and surrounding areas into the future. The proposed location minimizes potential negative impacts of a new substation on existing and future residential areas, secures a location in an area already developed for industrial uses, and supports PGE’s long-term plans for the provision of electrical services in this area of the region.

The Memorial Substation is a facility that converts high voltage (115,000 volts) transmission level electricity travelling on high voltage lines down to a lower voltage (13,000 volts) so that it can be distributed out to neighborhoods for power supply to homes and businesses via local distribution lines. The high voltage of the equipment in the substation necessitates the need for more space between each individual piece of equipment, in addition to the clearance required for safe travel by workers and vehicles within the station while it is energized. It also dictates the distances needed between the equipment and other metal objects (fences) and trees, which can conduct electricity and cause arcing. This prevents accidental electrical arcing between equipment and either other equipment or people, which would cause safety concerns for workers and nearby residents/pedestrians and electrical service reliability issues.

### ***Site Context***

The site is approximately 4.32 acres and is located between Interstate 5 and SW Parkway Avenue, just north of the intersection with SW Boeckman Road. The development area for the proposed Memorial Substation is approximately 185,272 square feet which will be primarily gravel area and landscape area. Currently, the development area is vacant with primarily grass vegetation and a few scattered small trees. The site is bounded by I-5 on the west, SW Parkway Avenue on the east, a church on the north, and a garden supply store to the south. Access to the substation will be from SW Parkway Avenue via two driveways. There is a City of Wilsonville designed Heritage Tree (Failmezger Tree) location in the right-of-way on SW Parkway Avenue adjacent to the property.

### ***Requested Approvals***

PGE is requesting the approval of a Type III Conditional Use Permit and Type II Site Design Review. Both applications will be reviewed under a Type III process with a public hearing and a decision by the Development Review Board.

### ***Key Issues and Discussion Items***

A pre-application conference for the development of the substation took place on February 2, 2023 (PRE23-0001 - New PGE Substation). During the conference and in the meeting notes City of Wilsonville staff identified the following special concerns and discussion items that should be addressed by the applicant.

### **Transmission Lines**

While this application is focused on the development of the Memorial Substation facility, there are also associated modifications to the existing high voltage (115,000 volt) transmission

system which supplies electricity to all PGE substations for conversion into lower voltages appropriate for local distribution to homes and businesses. These transmission lines are the pathways that PGE utilizes to move large amounts of electricity around the regional grid, and because of this, redundant links between substations (usually two or three), are required to ensure that there are back-up pathways in the case of storms or other impacts to the lines. Constructing multiple transmission links between each substation is one way that PGE is improving the grid to increase reliability and resilience of our system.

For this project, the existing transmission line running north/south along SW Boones Ferry Road will be “spilt” into two lines that will then both cross over SW Boones Ferry Road and Interstate-5 directly into the substation facility. This will provide the initial two transmission sources into the substation and is the least impact option since it will only require the addition of two new spans of transmission wire (for the highway crossing) and occurs entirely within existing right-of-way (City of Wilsonville and Oregon Department of Transportation). This provides links between the new Memorial substation and the existing Sherwood substation and existing Wilsonville substation. Even though the existing Wilsonville substation is very close, it still requires a link, and is in turn tied to the existing Rosemont substation. Alternatives to the proposed routing would require new overhead transmission lines along SW Parkway Avenue between SW Boeckman Road and the new facility which is less desirable to the City of Wilsonville.

PGE transmission planning is continually evaluating how to modify the grid to accommodate load growth and maintain the best level of service. As the system develops and electric demand changes, the substation layout allows for a future third transmission source at a later date, if needed.

### Heritage Tree

The pre-application notes state that ‘The presence of the Heritage Tree and other trees onsite will require a thorough arborist report. For the protection of the Heritage Tree during construction it will be necessary for a certified arborist to determine the location of the roots. Tree Protection fencing at the dripline may not be sufficient. Additionally, all proposed and future plans for construction and electric lines must avoid any potential impact to the Heritage Tree now and in the future, including but not limited to the trimming of canopy and impact to the root zone’.

A detailed Arborist Report on the Failmezger Tree is included with this application as Exhibit D. The arborist determined the location of the root zone of the tree and PGE has designed all elements of the substation to avoid any impacts or future impacts to the root zone of the tree. The permanent perimeter fence, electrical lines and landscaping avoid any impacts to the root zone, canopy, and drip line of the Heritage Tree. The perimeter fence has been specifically notched to avoid impact with the root zone. A Tree Preservation and Protection Plan (Exhibit A) shows 5 ft high protection fencing with signage during construction. PGE is also considering uplighting for the Heritage Tree, an Oregon White Oak, as part of this project to highlight the

Heritage Tree for the community. If the landscape lighting is implemented, no digging or impacts within the root zone will be allowed. The Tree Preservation and Protection Plan (Exhibit A) contains a tree table identifying all trees on or directly adjacent to the site. No trees will be removed or impacted by the development of the site.

### Noise and Visual Impacts

The pre-application notes state that ‘Consideration must be given to existing conditions of surrounding development and minimizing visual and noise impact. Given these considerations landscaping, more specifically screening and buffering, will be a large component of the application. To determine whether the High Screen Landscaping Standard or High Wall Standard will be applied information regarding noise generation shall be submitted with the application’.

High screen landscape is proposed on three sides of the substation: along SW Parkway Ave (where not in conflict with the Heritage Tree), along the boundary of the church property to the north, and along the boundary with the garden center to the south. An 8-foot high *Partially Sight-Obscuring Fence* surrounds the development. Only stormwater facilities and an access drive are proposed between the fence and high screen landscape and the adjacent properties. PGE designs all new facilities with dark sky fixtures and attempts to minimize light pollution to the greatest extent possible. A detailed Lighting Study is provided as Exhibit G to this application. The PGE property will be adequately screened to minimize visual impact to adjacent properties.

To address potential noise impacts, the PGE transformers are the only equipment that emits a consistent sound within the facility. The technical specifications set a maximum sound level for the transformers, and the manufacturer will provide test data to confirm actual values prior to it leaving the factory (they are typically lower than specified). The transformer specification calls for -10 dB relative to NEMA TR1 standard. NEMA lists 78dB when all fan stages are on so they would be 68dB with all fan stages on. This would be our loudest scenario. Actual sound tests will be completed during factory acceptance testing. For comparison, 68dB is about normal conversation level. The overall low level of noise will be produced by the substation. The project proposes the high screen landscape to mitigate any potential noise impacts to adjacent properties. In addition, the site and the adjacent properties sit direct adjacency to the consistent high level of noise from Interstate 5 and it is unlikely any sound emitted from the substation would impact adjacent properties greater than they experience under current conditions.

Figure 1: Zoning Map

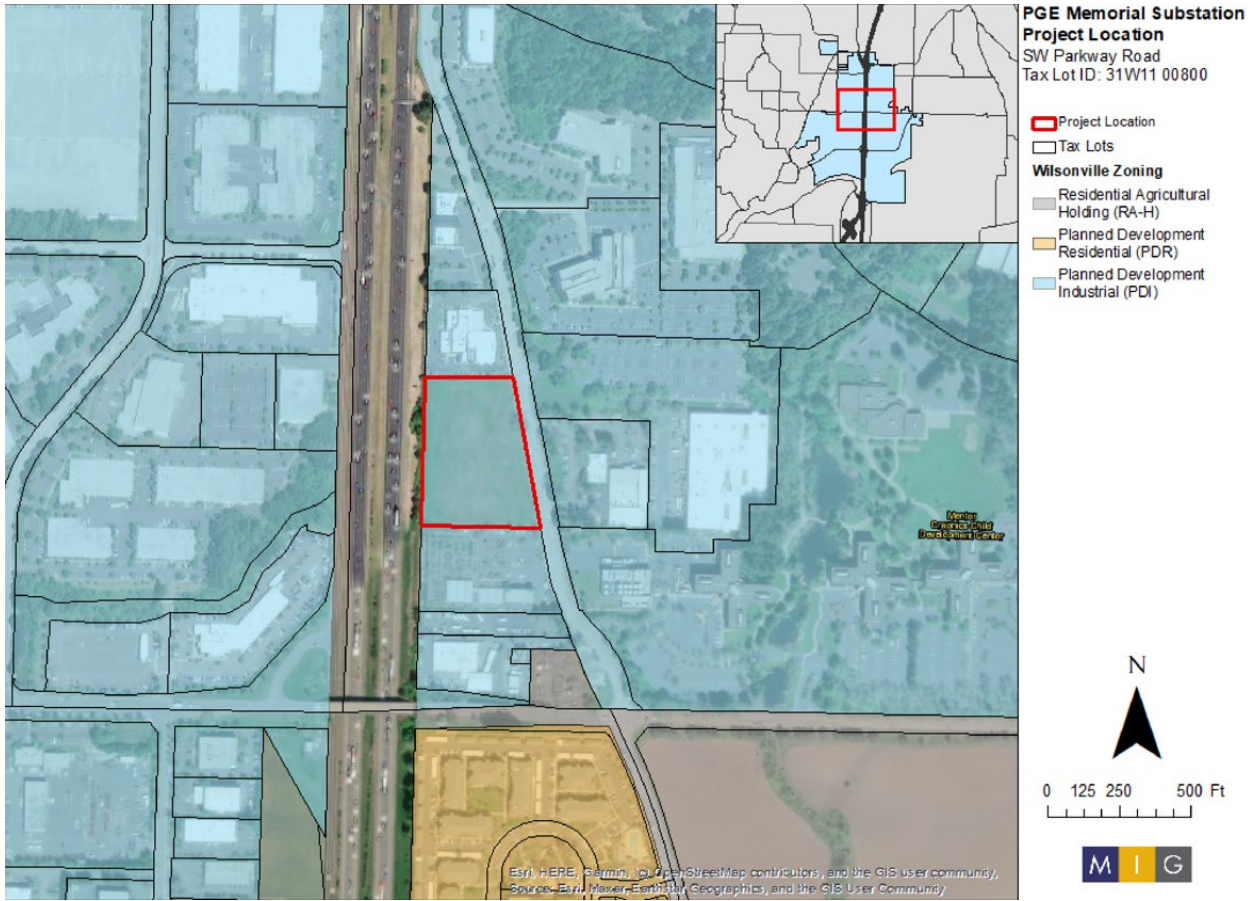



## IV. Conformance with Wilsonville Development Code

Compliance with applicable standards in the following sections of the Wilsonville Development Code are addressed below:

### PDI Development Standards

- A. Section 4.135 – Planned Development Industrial Zone  
Planned Development Standards and Regulations for all Planned Development (PD) Zones
- B. Section 4.118 – Standards Applying to all Planned Development (PD)
- C. Section 4.140 - Planned Development Regulations  
Site Design Review
- D. Section 4.400 – Site Design Review  
General Development Regulations
- E. Section 4.171 – Protection of Natural Features and Other Resources
- F. Section 4.175 – Public Safety and Crime Prevention
- G. Section 4.176 – Landscaping Screening and Buffering
- H. Section 4.177 – Street and Improvement Standards
- I. Section 4.199 – Outdoor Lighting  
Conditional Use
- J. Section 4.184 – Conditional Use Permits  
Underground Utility Regulations
- K. Sections 4.300 through 4.320  
Tree Preservation and Protection
- L. Section 4.620 – Tree Protection During Construction

### **A. PDI Development Standards**

#### ***Section 4.135 – Planned Development Industrial Zone.***

*(.03) Uses that are typically permitted:*

**Response:** See responses to Section 4.184 below. Electrical substations are regulated as conditional uses in all zoning districts.

*(.04) Block and access standards. The PDI zone shall be subject to the same block and access standards as the PDC zone, Section 4.131(.02) and (.03).*

**Response:** As shown on the Site Development Plan (Exhibit A, Sheet C1), two driveway access points are provided along Parkway Avenue. None of the block and access standards in the PDC zone, section 4.131(.02 and (0.3) apply to electrical substations. The standards regulate residential and mixed-use development. Therefore, this standard is met.

*(.05) Performance Standards.*

*A. All uses and operations except storage, off-street parking, loading and unloading shall be confined, contained, and conducted wholly within completely enclosed buildings, unless outdoor activities have been approved as part of Stage II, Site Design or Administrative Review.*

**Response:** This application is for Site Design Review. See responses to Site Design Review, Section 4.421.

*B. Vibration. Every use shall be so operated that the ground vibration inherently and recurrently generated from equipment other than vehicles is not perceptible without instruments at any boundary line of the property on which the use is located.*

**Response:** No ground vibrations perceptible without instruments are expected with this use. Therefore, this standard is met.

*C. Emission of odorous gases or other odorous matter in quantities as detectable at any point on any boundary line of the property on which the use is located shall be prohibited.*

**Response:** No odorous gases or other odorous matter are expected with this use. No gases or other matter will be emitted from the substation. Therefore, this standard is met.

*D. Any open storage shall comply with the provisions of Section 4.176, and this Section.*

**Response:** Any open storage will be contained behind a screening fence and comply with the provisions of Section 4.176. See responses to Section 4.176 for compliance with this standard. Therefore, this standard is met.

*E. No building customarily used for night operation, such as a baker or bottling and distribution station, shall have any opening, other than stationary windows or required fire exits, within 100 feet of any residential district and any space used for loading or unloading commercial vehicles in connection with such an operation shall not be within 100 feet of any residential district.*

**Response:** No buildings used for night operation are proposed with this use. Therefore, this standard does not apply.

*F. Heat and Glare:*

1. Operations producing heat or glare shall be conducted entirely within an enclosed building.
2. Exterior lighting on private property shall be screened, baffled, or directed away from adjacent residential properties. This is not intended to apply to street lighting.

**Response:** No heat or glare will be produced by the substation. A Photometric Plan and Lighting Study have been prepared and submitted with this application. The site is not adjacent to residential properties. Therefore, this standard is met.

*G. Dangerous Substances.* Any use which involves the presence, storage or handling of any explosive, nuclear waste product, or any other substance in a manner which would cause a health or safety hazard for any adjacent land use or site shall be prohibited.

**Response:** No dangerous substances will be present on site. Therefore, this standard does not apply.

*H. Liquid and Solid Wastes:*

1. *Any storage of wastes which would attract insects or rodents or otherwise create a health hazard shall be prohibited.*
2. *Waste products which are stored outside shall be concealed from view from any property line by a sight-obscuring fence or planting as required in Section 4.176.*
3. *No connection with any public sewer shall be made or maintained in violation of applicable City or State standards.*
4. *No wastes conveyed shall be allowed to or permitted, caused to enter, or allowed to flow into any public sewer in violation of applicable City or State standards.*
5. *All drainage permitted to discharge into a street gutter, caused to enter or allowed to flow into any pond, lake, stream, or other natural water course shall be limited to surface waters or waters having similar characteristics as determined by the City, County, and State Department of Environmental Quality.*
6. *All operations shall be conducted in conformance with the City's standards and ordinances applying to sanitary and storm sewer discharges.*

**Response:** No waste storage is proposed on site. All storage associated with the site is enclosed with the sight-obscuring fence and planning as required in Section 4.176. See Landscape Plan (Exhibit A) and responses to Section 4.176. No sewer or water connections, outside of water needed for irrigation, are necessary with this use. The only drainage on the site will be from surface waters or similar. See Exhibit E, Stormwater Report, for more information on stormwater drainage and conveyance. All stormwater drainage is in conformance with City standards. Therefore, this standard is met.

*I. Noise. Noise generated by the use, with the exception of traffic noises from automobiles, trucks, and trains, shall not violate any applicable standards adopted by the Oregon Department of Environmental Quality and W.C. 6.204 governing noise control in the same or similar locations.*

**Response:** The noise generated from this use will be minimal. Some noise is inherent to a substation. The noise generated for the transformer specification calls for -10 dB relative to NEMA TR1 standard. NEMA lists 78dB when all fan stages are on so it would be 68dB with all fan stages on. This would be our loudest scenario and not violate any applicable standards adopted by the Oregon Department of Environmental Quality. Therefore, this standard is met.

*J. Electrical Disturbances. Except for electrical facilities wherein the City is preempted by other governmental entities, electrical disturbances generated by uses within the PDI zone which interfere with the normal operation of equipment or instruments within the PDI Zone are prohibited. Electrical disturbances which routinely cause interference with normal activity in abutting residential use areas are also prohibited.*

**Response:** The proposed use is an electrical substation which is listed as an exception to this criteria. The substation should not create any electrical disturbances. Therefore, this standard does not apply.

*K. Discharge Standards. There shall be no emission of smoke, fallout, fly ash, dust, vapor, gases, or other forms of air pollution that may cause a nuisance or injury to human, plant, or animal life, or to property. Plans of construction and operation shall be subject to the recommendations and regulations of the State Department of Environmental Quality. All measurements of air pollution shall be by the procedures and with equipment approved by the State Department of Environmental Quality or equivalent and acceptable methods of measurement approved by the City. Persons responsible for a suspected source of air pollution upon the request of the City shall provide quantitative and qualitative information regarding the discharge that will adequately and accurately describe operation conditions.*

**Response:** No emissions such as smoke, fallout, fly ash, dust, vapor, or other forms of air pollution are expected or necessary with this use. Therefore, this standard is met.

*L. Open burning is prohibited.*

**Response:** No open burning is proposed or necessary with the proposed use. Therefore, this standard is met.

*M. Storage:*

- 1. Outdoor storage must be maintained in an orderly manner at all times.*
- 2. Outdoor storage area shall be gravel surface or better and shall be suitable for the materials being handled and stored. If a gravel surface is not sufficient to meet the performance standards for the use, the area shall be suitably paved.*
- 3. Any open storage that would otherwise be visible at the property line shall be concealed from view at the abutting property line by a sight obscuring fence or planting not less than six feet in height.*

**Response:** All outdoor storage will be on a gravel surface and concealed from abutting properties with a partial sight obscuring fence 8 feet in height and high screen landscape over six feet in height. See Site Development Plan (Exhibit A), Landscape Plan (Exhibit A) and Fence Detail (Exhibit H).

*N. Landscaping:*

- 1. Unused property, or property designated for expansion or other future use, shall be landscaped and maintained as approved by the Development Review Board. Landscaping for unused property disturbed during construction shall include such things as plantings of ornamental shrubs, lawns, native plants, and mowed, seeded fieldgrass.*
- 2. Contiguous unused areas of undisturbed fieldgrass may be maintained in their existing state. Large stands of invasive weeds such as Himalayan blackberries, English ivy, cherry Laurel, reed canary grass or other identified invasive plants shall be removed and/or mowed at least annually to reduce fire hazard. These unused areas, located within a phased development project or a future expansion cannot be included in the area calculated to meet the landscape requirements for the initial phase(s) of the development.*

3. *Unused property shall not be left with disturbed soils that are subject to siltation and erosion. Any disturbed soil shall be seeded for complete erosion cover germination and shall be subject to applicable erosion control standards.*

**Response:** The proposed development utilizes the entire property. No portions of the property will be unused or otherwise left undeveloped. Landscaping is provided in accordance with Section 4.176 (see responses below). Therefore, this standard is met.

*(.07) Other Standards:*

A. *Minimum Individual Lot Size.* No limit save and except as shall be consistent with the other provisions of this Code (e.g., landscaping, parking, etc.).

**Response:** Minimum lot size standards do not apply. Therefore, this standard is met.

B. *Maximum Lot Coverage.* No limit save and except as shall be consistent with the other provisions of this Code (e.g., landscaping, parking, etc.).

**Response:** Maximum lot coverage does not apply. Therefore, this standard is met.

C. *Front Yard Setback.* Thirty (30) feet. Structures on corner or through lots shall observe the minimum front yard setback on both streets. Setbacks shall also be maintained from the planned rights-of-way shown on any adopted City street plan.

**Response:** As shown on the Site Development Plan (Exhibit A, Sheet C1), a minimum 30-foot setback is shown on the front property line. This is after the ROW dedication.

D. *Rear and Side Yard Setback.* Thirty (30) feet. Structures on corner or through lots shall observe the minimum rear and side yard setbacks on both streets. Setbacks shall also be maintained from the planned rights-of-way shown on any adopted City street plan.

**Response:** As shown on the Site Development Plan (Exhibit A, Sheet C1), a minimum 30-foot setback is provided at the side and rear property lines. Therefore, this standard is met.

E. No setback is required when side or rear yards abut on a railroad siding.

**Response:** A railroad is not adjacent to the site. Therefore, this standard does not apply.

F. Corner Vision: Corner lots shall have no sight obstruction to exceed the vision clearance standards of Section 4.177.

**Response:** This site is not a corner lot. Therefore, this standard does not apply.

G. Off-Street Parking and Loading: As provided in Section 4.155.

**Response:** No parking is proposed for this use. The substation is not open to the public and will not have staff on site. The only vehicle traffic to the site will be for maintenance and upkeep as needed. Therefore, this standard is met.

H. Signs: As provided in Sections 4.156.01 through 4.156.11.

**Response:** Other than signage necessary for the safety of the substation and its operators, no other signage is proposed. Therefore, this standard is met.

***B. Planned Development Standards and Regulations for all Planned Development (PD) Zones***

***Section 4.118 – Standards Applying to all Planned Development (PD)***

*(.01) Height Guidelines. In "S" overlay zones, the solar access provisions of Section 4.137 shall be used to determine maximum building heights. In cases that are subject to review by the Development Review Board, the Board may further regulate heights as follows:*

*A. Restrict or regulate the height or building design consistent with adequate provision of fire protection and fire-fighting apparatus height limitations.*

*B. To provide buffering of low density developments by requiring the placement of three or more story buildings away from the property lines abutting a low density zone.*

*C. To regulate building height or design to protect scenic vistas of Mt. Hood or the Willamette River.*

*D. In no case shall the height of duplexes, triplexes, fourplexes, or townhouses be limited to less than the maximum height allowed for detached single-family dwellings in the same zone. In addition, in no case shall the height of triplexes, fourplexes, or townhouses be limited to less than 25 feet.*

**Response:** The property is not located in a "S" overlay zone. This standard is not applicable.



*(.02) Underground Utilities shall be governed by Sections 4.300 to 4.320. All utilities above ground shall be located so as to minimize adverse impacts on the site and neighboring properties.*

**Response:** See responses to Section 4.300 to 4.320 below.

*(.09) Habitat-Friendly Development Practices. To the extent practicable, development and construction activities of any lot shall consider the use of habitat-friendly development practices, which include:*

*A. Minimizing grading, removal of native vegetation, disturbance and removal of native soils, and impervious area;*

**Response:** The existing conditions on the site are mostly flat with only grass. Existing trees and vegetation on the west side of the site will be preserved along with the heritage tree. Grading is minimized to account for leveling the site for the substation equipment and required stormwater detention. See Exhibit A, Grading and Utility Plan, Sheet C2.

*B. Minimizing adverse hydrological impacts on water resources, such as using the practices described in Part (a) of Table NR-2 in Section 4.139.03, unless their use is prohibited by an applicable and required state or federal permit, such as a permit required under the federal Clean Water Act, 33 U.S.C. §§ 1251 et seq., or the federal Safe Drinking Water Act, 42 U.S.C. §§ 300f et seq., and including conditions or plans required by such permit;*

**Response:** The proposed development includes a bioretention detention pond for filtering rainwater, on site detention and stormwater drainage. See Stormwater Report, Exhibit E for compliance with Habitat-Friendly Development Practices in table NR-2. The development does not impact resources listed in Section 4.139.03.

*C. Minimizing impacts on wildlife corridors and fish passage, such as by using the practices described in Part (b) of Table NR-2 in Section 4.139.03; and*

**Response:** No wildlife corridors or fish passages are present on-site. Therefore, this standard does not apply.

*D. Using the practices described in Part (c) of Table NR-2 in Section 4.139.03.*

**Response:** Native vegetation will be used in the landscaping as shown in the Landscape Plan (Exhibit A). No Significant Resource Overlay Zones are on or adjacent to the site, therefore, there will not be light spill-off into a Significant Resource Overlay Zone. All existing trees on the property will be preserved. Therefore, this standard is met.

#### ***Section 4.140 - Planned Development Regulations***

**Response:** The proposed substation is located on a single lot owned by PGE. Lots adjacent to the subject lot are developed and under different ownership. No Planned Development permit is proposed with this application. Therefore, this section is not applicable.

### **C. Site Design Review**

#### ***Section 4.400. Purpose.***

*(.01) Excessive uniformity, inappropriateness or poor design of the exterior appearance of structures and signs and the lack of proper attention to site development and landscaping in the business, commercial, industrial and certain residential areas of the City hinders the harmonious development of the City, impairs the desirability of residence, investment or occupation in the City, limits the opportunity to attain the optimum use in value and improvements, adversely affects the stability and value of property, produces degeneration of property in such areas and with attendant deterioration of conditions affecting the peace, health and welfare, and destroys a proper relationship between the taxable value of property and the cost of municipal services therefor.*

*(.02) The City Council declares that the purposes and objectives of site development requirements and the site design review procedure are to:*

*A. Assure that Site Development Plans are designed in a manner that insures proper functioning of the site and maintains a high quality visual environment.*

*B. Encourage originality, flexibility and innovation in site planning and development, including the architecture, landscaping and graphic design of said development;*

*C. Discourage monotonous, drab, unsightly, dreary and inharmonious developments;*

*D. Conserve the City's natural beauty and visual character and charm by assuring that structures, signs and other improvements are properly related to their sites, and to surrounding sites and structures, with due regard to the aesthetic qualities of the natural terrain and*

*landscaping, and that proper attention is given to exterior appearances of structures, signs and other improvements;*

*E. Protect and enhance the City's appeal and thus support and stimulate business and industry and promote the desirability of investment and occupancy in business, commercial and industrial purposes;*

*F. Stabilize and improve property values and prevent blighted areas and, thus, increase tax revenues;*

*G. Insure that adequate public facilities are available to serve development as it occurs and that proper attention is given to site planning and development so as to not adversely impact the orderly, efficient and economic provision of public facilities and services.*

*H. Achieve the beneficial influence of pleasant environments for living and working on behavioral patterns and, thus, decrease the cost of governmental services and reduce opportunities for crime through careful consideration of physical design and site layout under defensible space guidelines that clearly define all areas as either public, semi-private, or private, provide clear identity of structures and opportunities for easy surveillance of the site that maximize resident control of behavior—particularly crime;*

*I. Foster civic pride and community spirit so as to improve the quality and quantity of citizen participation in local government and in community growth, change and improvements;*

*J. Sustain the comfort, health, tranquility and contentment of residents and attract new residents by reason of the City's favorable environment and, thus, to promote and protect the peace, health and welfare of the City.*

**Response:** The Wilsonville area is currently experiencing increases in electrical demand due to continuing residential growth as well as new commercial and industrial facilities with substantial electrical supply needs. This increase in demand necessitates the development of a new substation to create additional capacity. The substation will expand capacity in Wilsonville, ensuring adequate facilities are available to serve existing users and allow for new development, thereby promoting the desirability of investment and occupancy in business, commercial and industrial purposes and improving property values. Adequate electrical service is needed to sustain the comfort, health, tranquility and contentment of residents and to attract new residents by reason of the city's favorable environment and, thus, to promote and protect the peace, health and welfare of the City. The new PGE Memorial Substation will provide this service.

The project as submitted complies with the applicable criteria of Wilsonville's Planning and Development Ordinance to ensure a high quality and functioning visual environment is maintained in the city. The site design was crafted by a team of engineers, planners, arborists, and landscape architects to ensure creative design and to minimize impacts from the electrical substation. As a substation, the use is unique and is not monotonous or duplicative in the city. Special care was taken in the design of the substation to mitigate any impacts to surrounding property owners and users of public rights-of-way. Special care was taken to work around the

Wilsonville designed Heritage Tree (Failmezger Tree) located in the right-of-way on Parkway Ave adjacent to the site. An Arborist Report is included in the application and the tree is being preserved and protected. All other trees on-site or adjacent to the development are preserved.. High screen landscape and fencing is proposed to mitigate any visual or noise impacts to the adjacent properties. Adequate fencing and lighting are provided to prevent crime. The site is fully fenced with signs stating that the property is not accessible to the public.

Therefore, these objectives are met.

***Section 4.421 – Criteria and Application of Design Standards.***

*(.01) The following standards shall be utilized by the Board in reviewing the plans, drawings, sketches and other documents required for Site Design Review.*

*A. Preservation of Landscape. The landscape shall be preserved in its natural state, insofar as practicable, by minimizing tree and soils removal, and any grade changes shall be in keeping with the general appearance of neighboring developed areas.*

**Response:** The existing lot is primarily flat and featureless. The site was previously filled with outside dirt and gravel. Minimal grading is proposed to accommodate drainage and the substation equipment. The existing trees on the west side of the property and the Failmezger Heritage Tree in the ROW adjacent to the property on SW Parkway Road will be preserved.

*B. Relation of Proposed Buildings to Environment. Proposed structures shall be located and designed to assure harmony with the natural environment, including protection of steep slopes, vegetation and other naturally sensitive areas for wildlife habitat and shall provide proper buffering from less intensive uses in accordance with Sections 4.171 and 4.139 and 4.139.5. The achievement of such relationship may include the enclosure of space in conjunction with other existing buildings or other proposed buildings and the creation of focal points with respect to avenues of approach, street access or relationships to natural features such as vegetation or topography.*

**Response:** No steep slopes or naturally sensitive areas are present on the property. Therefore, this standard does not apply.

*C. Drives, Parking and Circulation. With respect to vehicular and pedestrian circulation, including walkways, interior drives and parking, special attention shall be given to location and number of access points, general interior circulation, separation of pedestrian and vehicular traffic, and arrangement of parking areas that are safe and convenient and, insofar as practicable, do not detract from the design of proposed buildings and structures and the neighboring properties.*

**Response:** The development will have two new access driveways along SW Parkway Avenue that will be gated. The driveways are 30 feet wide standard asphalt pavement. The location of the driveways allow the safest and most convenient access to the site for PGE or emergency personnel. The substation will not be accessible to public vehicles or pedestrians. The volume of vehicles accessing the driveway is extremely low: once or twice a month, and no daily trips during peak hours. A Traffic Memo (Exhibit F) has been prepared for this application. Based on the analysis, the proposed access locations and spacing are not a safety concern as proposed on the site plan because the project site generates such a low volume of vehicle trips (see Vehicle Trip Generation),. However, an exception or variance to the City’s Public Works Construction Standards will be required and is submitted as Exhibit K. Therefore, this standard is met.

*D. Surface Water Drainage. Special attention shall be given to proper site surface drainage so that removal of surface waters will not adversely affect neighboring properties of the public storm drainage system.*

**Response:** Two landscaped bioretention detention ponds are proposed to be located at the northwest and southwest corners of the f the property to filter and control stormwater drainage from the site without adversely impacting adjacent properties. Both ponds discharge directly to the existing public storm mains that outfall into swales in the adjacent ODOT right-of-way. Detailed information on the proposed surface water drainage is located in Exhibit E, Stormwater Report. Therefore, this standard is met.

*E. Utility Service. Any utility installations above ground shall be located so as to have a harmonious relation to neighboring properties and site. The proposed method of sanitary and storm sewage disposal from all buildings shall be indicated*

**Response:** The proposed substation will feature three new electrical poles on the west side of the property. These poles will connect the substation to the rest of the grid and are necessary for use of the property as a substation. The visual impact of the substation will be minimized through landscaping and fence screening and the location of the poles on the west side of the property (adjacent to I-5). No sanitary sewage is necessary with this development. Therefore, this standard is met.

*F. Advertising Features. In addition to the requirements of the City's sign regulations, the following criteria should be included: the size, location, design, color, texture, lighting and materials of all exterior signs and outdoor advertising structures or features shall not detract from the design of proposed buildings and structures and the surrounding properties.*

**Response:** No signage other than the required safety signage is proposed. Therefore, this standard is met.

*G. Special Features. Exposed storage areas, exposed machinery installations, surface areas, truck loading areas, utility buildings and structures and similar accessory areas and structures shall be subject to such setbacks, screen plantings or other screening methods as shall be required to prevent their being incongruous with the existing or contemplated environment and its surrounding properties. Standards for screening and buffering are contained in Section 4.176.*

**Response:** All aspects of the substation including exposed machinery, utilities, and accessory areas are located outside of the required setbacks. All aspects of the substation are located behind an 8-foot screening fence. A high screen landscape is proposed where the property abuts SW Parkway Avenue and the adjacent North and South properties. All standards from screening and buffering are being met. See responses to Section 4.176. See Landscape Plan, Exhibit A for fencing location and proposed buffering. Therefore, this standard is met.

*(.02) The standards of review outlined in Sections (a) through (g) above shall also apply to all accessory buildings, structures, exterior signs and other site features, however related to the major buildings or structures.*

**Response:** No accessory structures, exterior signs, or other site features related to the substation are proposed. All proposed structures meet sections (a) through (g). Therefore, this standard does not apply.

*(.03) The Board shall also be guided by the purpose of Section 4.400, and such objectives shall serve as additional criteria and standards.*

**Response:** The applicant is aware that the purpose and objectives for Site Design Review outlined in Section 4.400 will be considered by the Development Review Board. The objectives are broad and discretionary. A response by the applicant to the purpose and objectives is provided above in Section 4.400.

*(.04) Conditional application. The Planning Director, Planning Commission, Development Review Board or City Council may, as a Condition of Approval for a zone change, subdivision, land partition, variance, conditional use, or other land use action, require conformance to the site development standards set forth in this Section.*

**Response:** See responses to Section 4.184 below in this narrative. This applicant is requesting conditional use approval in conjunction with the Site Design Review. Therefore, this standard is met.

***Section 4.430. - Location, Design and Access Standards for Mixed Solid Waste and Recycling Areas.***

(.01) The following locations, design and access standards for mixed solid waste and recycling storage areas shall be applicable to the requirements of [Section 4.179](#) of the Wilsonville City Code.

**Response:** Section 4.179 is not applicable to this proposal as no new multi-family or non-residential buildings are proposed with the development. Therefore, this section is not applicable.

***Section 4.440. - Procedure.***

(.01) *Submission of Documents.* A prospective applicant for a building or other permit who is subject to site design review shall submit to the Planning Department, in addition to the requirements of Section 4.035, the following:

- A. A site plan, drawn to scale, showing the proposed layout of all structures and other improvements including, where appropriate, driveways, pedestrian walks, landscaped areas, fences, walls, off-street parking and loading areas, and railroad tracks. The site plan shall indicate the location of entrances and exits and direction of traffic flow into and out of off-street parking and loading areas, the location of each parking space and each loading berth and areas of turning and maneuvering vehicles. The site plan shall indicate how utility service and drainage are to be provided.

**Response:** A Site Development Plan, Sheet C1 is submitted as Exhibit A to this application. It meets the site plan requirements applicable to the substation development. This criteria is met.

- B. A Landscape Plan, drawn to scale, showing the location and design of landscaped areas, the variety and sizes of trees and plant materials to be planted on the site, the location and design of landscaped areas, the varieties, by scientific and common name, and sizes of trees and plant materials to be retained or planted on the site, other pertinent landscape features, and irrigation systems required to maintain trees and plant materials. An inventory, drawn at the same scale as the Site Plan, of existing trees of four inch caliper or more is required. However, when large areas of trees are proposed to be retained undisturbed, only a survey identifying the location and size of all perimeter trees in the mass is necessary.



**Response:** A Landscape Plan and Tree Preservation and Protection Plan is submitted as Exhibit A to this application. It meets the landscape plan requirements applicable to the substation development. This criteria is met.

- C. Architectural drawings or sketches, drawn to scale, including floor plans, in sufficient detail to permit computation of yard requirements and showing all elevations of the proposed structures and other improvements as they will appear on completion of construction. Floor plans shall also be provided in sufficient detail to permit computation of yard requirements based on the relationship of indoor versus outdoor living area, and to evaluate the floor plan's effect on the exterior design of the building through the placement and configuration of windows and doors.

**Response:** The Site Development Plan shows the approximate location of all PGE equipment and improvements proposed with the development. No buildings are proposed with this development. No architectural plans are provided. See Exhibit A, Site Development Plan, Sheet C1 for compliance with this criteria. This criteria is met.

- D. A Color Board displaying specifications as to type, color, and texture of exterior surfaces of proposed structures. Also, a phased development schedule if the development is constructed in stages.

**Response:** No structures, other than electrical substation equipment are proposed with this development. A color board is not applicable.

This application is to develop the new substation facility and associated site improvements. At construction a single distribution transformer and two transmission sources will be installed which will allow for the sharing of load with the existing substations to allow for their continued use. When the existing Wilsonville substation reaches the end of its service life, a second and third distribution transformer and a third transmission source will be added in the gravel yard of the substation, and the existing Wilsonville substation will be decommissioned. This will allow PGE to provide reliable and cost-effective electricity service to Wilsonville customers now and into the future. Note the entire substation will be developed with this application. Only additional PGE equipment (second and third distribution transformer/switchgear) is proposed to be added at a later date within the developed facility. There is not an approximate timeline for the additional equipment installation. No site expansion or alterations will be required for the installation of the future equipment.

The Site Development Plan (Exhibit A, sheet C1) shows the phasing of the equipment installation. Therefore, this criteria is met.



- E. A sign Plan, drawn to scale, showing the location, size, design, material, color and methods of illumination of all exterior signs.

**Response:** A Sign Plan (Exhibit A) is provided with this application. It shows location, design, materials and size of all signs proposed on the site. No illuminated exterior signs are proposed. Signs are for PGE staff direction and safety. Any signs located outside the sight obscuring fence will obtain a sign permit if required. No public access will be permitted on the site. This criteria is met.

- F. The required application fee.

**Response:** All application fees were paid upon submittal of the applications.

***Section 4.450. - Installation of Landscaping.***

(.01) All landscaping required by this section and approved by the Board shall be installed prior to issuance of occupancy permits, unless security equal to 110 percent of the cost of the landscaping as determined by the Planning Director is filed with the City assuring such installation within six months of occupancy. "Security" is cash, certified check, time certificates of deposit, assignment of a savings account or such other assurance of completion as shall meet with the approval of the City Attorney.

(.02) Action by the City approving a proposed landscape plan shall be binding upon the applicant. Substitution of plant materials, irrigation systems, or other aspects of an approved landscape plan shall not be made without official action of the Planning Director or Development Review Board, as specified in this Code.

(.03) All landscaping shall be continually maintained, including necessary watering, weeding, pruning, and replacing, in a substantially similar manner as originally approved by the Board, unless altered with Board approval.

**Response:** All landscaping as shown on Exhibit A, Landscape Plan will be installed prior to issuance of occupancy permits and shall be maintained in a manner originally approved by the Board. See notes on Exhibit A – Landscape Plan for more detail on landscape installation and maintenance.

***D. General Development Regulations***

***Section 4.171 – Protection of Natural Features and Other Resources***

*(.02) General Terrain Preparation:*

*A. All developments shall be planned, designed, constructed and maintained with maximum regard to natural terrain features and topography, especially hillside areas, floodplains, and other significant landforms.*

**Response:** The existing terrain is primarily flat and featureless. No floodplains, hillsides, or other significant landforms are present. The proposed grading will have minimal impact on the natural terrain. Therefore, this standard is met.

*B. All grading, filling and excavating done in connection with any development shall be in accordance with the Uniform Building Code.*

**Response:** The Grading and Utility Plans, Sheet C2 have been submitted as Exhibit A for review by City of Wilsonville engineering and building departments. No buildings are proposed with this development that would require review under the uniform building code. Therefore, this standard is met.

*C. In addition to any permits required under the Uniform Building Code, all developments shall be planned, designed, constructed and maintained so as to:*

- 1. Limit the extent of disturbance of soils and site by grading, excavation and other land alterations.*
- 2. Avoid substantial probabilities of: (1) accelerated erosion; (2) pollution, contamination, or siltation of lakes, rivers, streams and wetlands; (3) damage to vegetation; (4) injury to wildlife and fish habitats.*
- 3. Minimize the removal of trees and other native vegetation that stabilize hillsides, retain moisture, reduce erosion, siltation and nutrient runoff, and preserve the natural scenic character.*

**Response:** The extent of site grading is shown on the Grading and Utility Plans, Sheet C2 (Exhibit A). Grading will be done to minimize the impact of erosion. No lakes, rivers, streams, wetlands, or wildlife habitats are present on the site. All existing trees on-site will be preserved. Therefore, this standard is met.

*(.04) Trees and Wooded Areas:*

*A. All developments shall be planned, designed, constructed and maintained so that:*

- 1. Existing vegetation is not disturbed, injured, or removed prior to site development and prior to an approved plan for circulation, parking and structure location.*

2. *Existing wooded areas, significant clumps/groves of trees and vegetation, and all trees with a diameter at breast height of six inches or greater shall be incorporated into the development plan and protected wherever feasible.*
3. *Existing trees are preserved within any right-of-way when such trees are suitably located, healthy, and when approved grading allows.*

**Response:** As shown in the Tree Protection Plan (Exhibit A), all existing trees on the site will be preserved. Therefore, this standard is met.

*B. Trees and woodland areas to be retained shall be protected during site preparation and construction according to City Public Works design specifications, by:*

1. *Avoiding disturbance of the roots by grading and/or compacting activity.*
2. *Providing for drainage and water and air filtration to the roots of trees which will be covered with impermeable surfaces.*
3. *Requiring, if necessary, the advisory expertise of a registered arborist/horticulturist both during and after site preparation.*
4. *Requiring, if necessary, a special maintenance, Management program to insure survival of specific woodland areas of specimen trees or individual heritage status trees.*

**Response:** As shown in the Tree Preservation and Protection Plan (Exhibit A), all existing trees on site will be preserved. An Arborist Report has been prepared and submitted (Exhibit D) with this application. The Failmezger Heritage Tree will be protected by a 6-foot chain-link fence that follows the edge of the 45-foot root protection zone during construction as recommended by the Arborist's report (Exhibit D). The permanent 8-foot site obscuring fence is proposed outside the 45-foot root protection zone determined by the arborist. The area in the root zone is proposed to be mulched and not disturbed. All other trees are off site, the majority of which are not implicated by the development of the substation but will be protected to meet Prescriptive Path Requirements. Trees 5520 and 5521 (10" and 14" Hawthorn, trunks located on ODOT Property) will likely have some root and crown encroachment on PGE property due to construction but are anticipated to remain. Tree protection measures meeting the Performance Path Requirements listed in the Arborists Report will be put in place to protect tree health for 5520 and 5521.

Therefore, this standard is met.

#### **Section 4.175 – Public Safety and Crime Prevention**

*(.01) All developments shall be designed to deter crime and insure public safety.*

**Response:** The substation will be surrounded by a 8-foot tall fence reinforced by metal panels and tension cross-bracing. The top 1-foot of the fence will consist of barbed wire and extension brackets to protect the facility from trespassing and vandalism.

*(.02) Addressing and directional signing shall be designed to assure identification of all buildings and structures by emergency response personnel, as well as the general public.*

**Response:** A Sign Plan (Exhibit A) is provided with this application. The property address will be displayed at the main gate entrance. Other required safety signage will be installed for the identification of structures for emergency personnel, public safety and the PGE employees. Therefore, this standard is met.

*(.03) Areas vulnerable to crime shall be designed to allow surveillance. Parking and loading areas shall be designed for access by police in the course of routine patrol duties.*

**Response:** When staff are not on site the gate to the site will be locked and closed. Adequate lighting will be provided to allow for surveillance of the property. See responses to Section 4.199 Outdoor Lighting below. Therefore, this standard is met.

*(.04) Exterior lighting shall be designed and oriented to discourage crime.*

**Response:** As shown in Exhibit G, Exterior Lighting Study and Cut Sheets, exterior lighting is provided throughout the property to allow for proper visibility. See responses to Section 4.199 Outdoor Lighting for more details on proposed exterior lighting. The property will be well lit and visible from the public right-of-way to discourage crime. Therefore, this standard is met.

### ***Section 4.176 – Landscaping Screening and Buffering***

*(.02) Landscaping and Screening Standards:*

*C. General Landscaping Standard:*

*2. Required materials. Shrubs and trees, other than street trees, may be grouped. Ground cover plants must fully cover the remainder of the landscaped area (see Figure 21: General Landscaping). The General Landscaping Standard has two different requirements for trees and shrubs:*

- a) Where the landscaped area is less than 30 feet deep, one tree is required for every 30 linear feet.*

- b) *Where the landscaped area is 30 feet deep or greater, one tree is required for every 800 square feet and two high shrubs or three low shrubs are required for every 400 square feet.*

**Response:** The Landscape Plan identifies where the landscape is 30 feet deep or greater. Trees and shrubs are provided to meet this standard See Landscaping Plan (Exhibit A).

*F. High Screen Landscaping Standard:*

*2. Required materials. The High Screen Landscaping Standard requires sufficient high shrubs to form a continuous screen at least six feet high and 95 percent opaque, year-round. In addition, one tree is required for every 30 linear feet of landscaped area, or as otherwise required to provide a tree canopy over the landscaped area. Ground cover plants must fully cover the remainder of the landscaped area. A six foot high masonry wall or a berm may be substituted for the shrubs, but the trees and ground cover plants are still required. When applied along street lot lines, the screen or wall is to be placed along the interior side of the landscaped area. (See Figure 24: High Screen Landscaping).*

**Response:** As shown in the Landscaping Plan (Exhibit A), in the proposed screening plants, minimum 6-foot tall evergreen shrubs (Myrica, Arbutus, Ceanothus and Juniper) are proposed along the north, south, and east property lines along with a mix of other shrubs, trees, and ground cover. The high screen standard is being used where the site abuts different uses, a garden center to the south, church to the north, and SW Parkway Avenue. The high screen landscaping is being implemented to reduce visual and noise impacts the new substation may have on the adjacent parcels. The high screen landscape applied along the street lot line on SW Parkway Avenue is placed along the interior side of the landscape area adjacent to the *Partially Sight-Obscuring Fence*. High screen landscape is being used in conjunction with a *Partially Sight-Obscuring Fence* to provide separation between the substation and the adjacent uses. A 6-foot masonry wall is not proposed.

*G. High Wall Standard:*

*1.Intent. The High Screen Landscaping Standard is a landscape treatment that relies primarily on screening to separate uses or developments. It is intended to be applied in situations where visual separation is required.*

*2. Required materials. The High Wall Standard requires a masonry wall at least six feet high along the interior side of the landscaped area (see Figure 25: High Wall Landscaping). In addition, one tree is required for every 30 linear feet of wall, or as otherwise required to provide a tree canopy over the landscaped area. Ground cover plants must fully cover the remainder of the landscaped area.*

**Response:** A high wall is not proposed. Noise and visual impacts of the substation do not require complete visual separation. This standard is not applicable.

*I. Partially Sight-Obscuring Fence Standard:*

1. *Intent.* The Partially Sight-Obscuring Fence Standard is intended to provide a tall, but not totally blocked, visual separation. The standard is applied where a low level of screening is adequate to soften the impact of one use or development on another, and where some visibility between abutting areas is preferred over a total visual screen. It can be applied in conjunction with landscape plantings or applied in areas where landscape plantings are not necessary and where nonresidential uses are involved.

2. *Required materials.* Partially Sight-Obscuring Fence Standard are to be at least six feet high and at least 50 percent sight-obscuring. Fences may be made of wood (other than plywood or particle-board), metal, bricks, masonry or other permanent materials (see Figure 27: Partially Sight-Obscuring Fence).

**Response:** As shown in Exhibit H (Fence details), the proposed 8-foot fence consists of expanded metal fabric with 1-foot of barbed wire. The fence will be partially sight-obscuring. The proposed fence will be adequate to soften the impact of the substation to the adjacent uses and it being applied in conjunction with high screen landscape. The Partial Sight-Obscuring Fence and high screen landscape is preferred over a total visual screen to allow for some visibility of the sight for security purposes. Therefore, this standard is met.

(.03) *Landscape Area.* Not less than 15 percent) of the total lot area, shall be landscaped with vegetative plant materials. The ten percent parking area landscaping required by section 4.155.03(B)(1) is included in the 15 percent total lot landscaping requirement. Landscaping shall be located in at least three separate and distinct areas of the lot, one of which must be in the contiguous frontage area. Planting areas shall be encouraged adjacent to structures. Landscaping shall be used to define, soften or screen the appearance of buildings and off-street parking areas. Materials to be installed shall achieve a balance between various plant forms, textures, and heights. The installation of native plant materials shall be used whenever practicable. (For recommendations refer to the Native Plant List maintained by the City of Wilsonville).

**Response:** As shown on the Landscape Plans (Exhibit A), the property is 185,272 SF and will have 28,881 SF of landscaping for approximately 15.5% of the site. The landscaping is provided in three distinct areas of the lot including the Parkway Avenue frontage, along the south property line, and along the north property line. Additional landscaping is located around the stormwater rain gardens. The intent of the landscaping is to meet the High Screening standards and stormwater standards. Native plant materials are used for the majority of species. All additional types used are well adapted to site conditions, low resource use and easy to maintain.

*(.04) Buffering and Screening.* Additional to the standards of this subsection, the requirements of the Section 4.137.5 (Screening and Buffering Overlay Zone) shall also be applied, where applicable.

**Response:** The site is not located in the Screening and Buffering Overlay Zone. This section is not applicable.

*(0.5) Sight-Obscuring Fence or Planting.* The use for which a sight-obscuring fence or planting is required shall not begin operation until the fence or planting is erected or in place and approved by the City. A temporary occupancy permit may be issued upon a posting of a bond or other security equal to 110 percent of the cost of such fence or planting and its installation. (See Sections 4.400 to 4.470 for additional requirements.)

**Response:** A sight obscuring-fence and plantings are proposed and will be installed prior to beginning operation. Therefore, this standard is met.

*(.06) Plant Materials:*

A. Shrubs and Ground Cover. All required ground cover plants and shrubs must be of sufficient size and number to meet these standards within three years of planting. Non-horticultural plastic sheeting or other impermeable surface shall not be placed under mulch. Native topsoil shall be preserved and reused to the extent feasible. Surface mulch or bark dust are to be fully raked into soil of appropriate depth, sufficient to control erosion, and are confined to areas around plantings. Areas exhibiting only surface mulch, compost or bark dust are not to be used as substitutes for plant areas.

1. *Shrubs.* All shrubs shall be well branched and typical of their type as described in current AAN Standards and shall be equal to or better than 2-gallon containers and ten inches to 12 inches spread.

2. *Ground cover.* Shall be equal to or better than the following depending on the type of plant materials used: gallon containers spaced at four feet on center minimum, four inch pot spaced two feet on center minimum, two one-fourth inch pots spaced at 18 inch on center minimum. No bare root planting shall be permitted. Ground cover shall be sufficient to cover at least 80 percent of the bare soil in required landscape areas within three years of planting. Where wildflower seeds are designated for use as a ground cover, the City may require annual re-seeding as necessary.

3. Turf or lawn in non-residential developments. Shall not be used to cover more than ten percent of the landscaped area, unless specifically approved based on a finding that, due to site conditions and availability of water, a larger percentage of turf or lawn area is appropriate. Use of lawn fertilizer shall be discouraged. Irrigation drainage runoff from lawns shall be retained within lawn areas.

4. Plant materials under trees or large shrubs. Appropriate plant materials shall be installed beneath the canopies of trees and large shrubs to avoid the appearance of bare ground in those locations.

5. Integrate compost-amended topsoil in all areas to be landscaped, including lawns, to help detain runoff, reduce irrigation and fertilizer needs, and create a sustainable, low-maintenance landscape.

**Response:** Plant materials have been selected to meet these standards. Sizes or densities will meet or exceed requirements. No landscape fabric is proposed for use. No bare root plantings are proposed for use. Seeded areas are proposed with self-sustaining types and are not anticipated to need reseeding. Plantings are not proposed for the area under the Heritage Tree to minimize disturbance and competition. See Exhibit A – Landscape Plan for the planting plan and plant palette.

B. *Trees.* All trees shall be well-branched and typical of their type as described in current American Association of Nurserymen (AAN) Standards and shall be balled and burlapped. The trees shall be grouped as follows:

1. Primary trees which define, outline or enclose major spaces, such as Oak, Maple, Linden, and Seedless Ash, shall be a minimum of two-inch caliper.

2. Secondary trees which define, outline or enclose interior areas, such as Columnar Red Maple, Flowering Pear, Flame Ash, and Honeylocust, shall be a minimum of 1¾ inch to 2 inch caliper.

3. Accent trees which, are used to add color, variation and accent to architectural features, such as Flowering Pear and Kousa Dogwood, shall be 1¾ inch minimum caliper.

4. Large conifer trees such as Douglas Fir or Deodar Cedar shall be installed at a minimum height of eight feet.



5. Medium-sized conifers such as Shore Pine, Western Red Cedar or Mountain Hemlock shall be installed at a minimum height of five to six feet.

**Response:** As shown in the Landscape Plan (Exhibit A) Trees List, the proposed trees are Mexican Blue Oak, Canyon Live Oak which have a 3” Caliper and Cascara which have a 1.75” caliper. Therefore, this standard is met.

D. *Street Trees.* In order to provide a diversity of species, the Development Review Board may require a mix of street trees throughout a development. Unless the Board waives the requirement for reasons supported by a finding in the record, different types of street trees shall be required for adjoining blocks in a development.

1. All trees shall be standard base grafted, well branched and typical of their type as described in current AAN Standards and shall be balled and burlapped (b&b). Street trees shall be planted at sizes in accordance with the following standards:

a. Arterial streets—Three inches minimum caliper

**Response:** The proposed street trees are Mexican Blue Oak and Canyon Live Oak, both of which have a mature height of 30’ and a 3” caliper. Therefore, this standard is met.

2. The following trees and varieties thereof are considered satisfactory street trees in most circumstances; however, other varieties and species are encouraged and will be considered:

a. Trees over 50 feet mature height: *Quercus garryana* (Native Oregon White Oak), *Quercus rubra borealis* (Red Oak), *Acer Macrophyllum* (Native Big Leaf Maple), *Acer nigrum* (Green Column Black Maple), *Fraxinus americanus* (White Ash), *Fraxinus pennsylvannica* 'Marshall' (Marshall Seedless Green Ash), *Quercus coccinea* (Scarlet Oak), *Quercus pulustris* (PinOak), *Tilia americana* (American Linden).

b. Trees under 50 feet mature height: *Acer rubrum* (Red Sunset Maple), *Cornus nuttallii* (Native Pacific Dogwood), *Gleditsia triacanthos* (Honey Locust), *Pyrus calleryana* 'Bradford' (Bradford Pear), *Tilia cordata* (Little Leaf Linden), *Fraxinus oxycarpa* (Flame Ash).

c. Other street tree species. Other species may be specified for use in certain situations. For instance, evergreen species may be specified where year-round color is desirable and no adverse effect on solar access is anticipated. Water-loving species may be specified in low locations where wet soil conditions are anticipated.

**Response:** The proposed street trees are Mexican Blue Oak and Canyon Live Oak, both have a mature height of 30' and a 3" caliper. The high voltage of the equipment in the substation dictates the distances needed between the equipment and trees, which can conduct electricity and cause arcing. The Mexican Blue Oak and Canyon Live Oak were selected to maintain a safe distance from the high voltage equipment. These trees were also selected as West Coast Oaks to reinforce the Oak Savanna character of the existing heritage tree. These varieties are very well adapted to conditions and are anticipated to be adaptable to future climate change. Therefore, this standard is met.

*E. Types of Plant Species:*

1. Existing landscaping or native vegetation may be used to meet these standards, if protected and maintained during the construction phase of the development and if the plant species do not include any that have been listed by the City as prohibited. The existing native and non-native vegetation to be incorporated into the landscaping shall be identified.
2. Selection of plant materials. Landscape materials shall be selected and sited to produce hardy and drought-tolerant landscaping. Selection shall be based on soil characteristics, maintenance requirements, exposure to sun and wind, slope and contours of the site, and compatibility with other vegetation that will remain on the site. Suggested species lists for street trees, shrubs and groundcovers shall be provided by the City of Wilsonville.
3. *Prohibited plant materials.* The City may establish a list of plants that are prohibited in landscaped areas. Plants may be prohibited because they are potentially damaging to sidewalks, roads, underground utilities, drainage improvements, or foundations, or because they are known to be invasive to native vegetation.

**Response:** Besides the Heritage Tree in the SW Parkway Avenue ROW, existing vegetation is not being used to meet the landscape standards. Landscape materials shall be selected and sited to produce hardy and drought-tolerant landscaping with the exception of the rain garden plants. A prohibited plant list is not established by the City or Wilsonville. Therefore, this standard is met.

*F. Tree Credit.* Existing trees that are in good health as certified by an arborist and are not disturbed during construction may count for landscaping tree credit as follows (measured at four and one-half feet above grade and rounded to the nearest inch):

**Response:** One existing tree, the Heritage Tree in the SW Parkway Avenue ROW has a 33' caliper and could be used for tree credit. An Arborist Report (Exhibit D) is provided demonstrating the health of the tree and a Tree Preservation and Protection Plan (Exhibit A) is also provided. However, no tree credit is being requested. Therefore, this standard is met.

9. *Landscape Plans.* Landscape plans shall be submitted showing all existing and proposed landscape areas. Plans must be drawn to scale and show the type, installation size, number and placement of materials. Plans shall include a plant material list. Plants are to be identified by both their scientific and common names. The condition of any existing plants and the proposed method of irrigation are also to be indicated. Landscape plans shall divide all landscape areas into the following categories based on projected water consumption for irrigation:

- A. High water usage areas ( $\pm$  two inches per week): small convoluted lawns, lawns under existing trees, annual and perennial flower beds, and temperamental shrubs;
- B. Moderate water usage areas ( $\pm$  one inch per week): large lawn areas, average water-using shrubs, and trees;
- C. Low water usage areas (Less than one inch per week, or gallons per hour): seeded fieldgrass, swales, native plantings, drought-tolerant shrubs, and ornamental grasses or drip irrigated areas.
- D. Interim or unique water usage areas: areas with temporary seeding, aquatic plants, erosion control areas, areas with temporary irrigation systems, and areas with special water-saving features or water harvesting irrigation capabilities.

These categories shall be noted in general on the plan and on the plant material list.

**Response:** See Landscape Plan (Exhibit A) for locations of plantings and irrigation needs. All plantings proposed are grouped by irrigation need, and all require low water usage for this project. An automatic irrigation system has not yet been designed, but will be provided to sustain plantings through establishment and into the future. No irrigation is proposed for existing plantings, in particular the Heritage Tree Oak.

10. *Completion of Landscaping.* The installation of plant materials may be deferred for a period of time specified by the Board or Planning Director acting on an application, in order to avoid hot summer or cold winter periods, or in response to water shortages. In these cases, a temporary permit shall be issued, following the same procedures specified in subsection (.07)(C)(3), above, regarding temporary irrigation systems. No final Certificate of Occupancy shall be granted until an adequate bond or other security is posted for the completion of the landscaping, and the City is given written authorization to enter the property and install the required landscaping, in the event that the required landscaping has not been installed. The form of such written authorization shall be submitted to the City Attorney for review.

**Response:** All landscaping will be installed at the end of construction. The applicant is not requesting to defer installation. Therefore, this standard is met.

*11. Street Trees Not Typically Part of Site Landscaping.* Street trees are not subject to the requirements of this Section and are not counted toward the required standards of this Section. Except, however, that the Development Review Board may, by granting a waiver or variance, allow for special landscaping within the right-of-way to compensate for a lack of appropriate on-site locations for landscaping. See subsection (.06), above, regarding street trees.

**Response:** A waiver for planting of landscaping in the right-of-way is not requested. Therefore, this standard does not apply.

#### ***Section 4.177 – Street and Improvement Standards***

*(.01) Development and related public facility improvements shall comply with the standards in this section, the Wilsonville Public Works Standards, and the Transportation System Plan, in rough proportion to the potential impacts of the development. Such improvements shall be constructed at the time of development or as provided by Section 4.140, except as modified or waived by the City Engineer for reasons of safety or traffic operations.*

**Response:** A Traffic Memo (Exhibit F), produced and signed by the City of Wilsonville, addresses the requirements for Street Frontage Improvements for this project. Please see Page 3 of the Traffic Memo. In summary, the Traffic Memo states, “Per discussions with the City, there are no additional Minor Arterial Street improvements along the project frontage that will be required of the applicant.” No street improvements are proposed or required with this development. The application meets the Public Works standards except for the access spacing requirements. The access spacing requirements are also addressed in the Traffic Memo (Exhibit F). The applicant provided a “Request to Waive Access Spacing Requirement in City of Wilsonville Public Works Construction Standards” via Memo to the City of Wilsonville City Engineer for their consideration. See Exhibit K.

#### *(.02) Street Design Standards:*

*A. All street improvements and intersections shall provide for the continuation of streets through specific developments to adjoining properties or subdivisions.*

- 1. Development shall be required to provide existing or future connections to adjacent sites through the use of access easements where applicable. Such easements shall be required in addition to required public street dedications as required in Section 4.236(.04).*

**Response:** No street access easements are necessary with this development. Therefore, this standard does not apply.

*B. The City Engineer shall make the final determination regarding right-of-way and street element widths using the ranges provided in Chapter 3 of the Transportation System Plan and the additional street design standards in the Public Works Standards.*

**Response:** As shown in the Site Development Plan (Exhibit A), the proposed development dedicates 6.5 feet of ROW along Parkway Avenue. According to Figure 3-2 of the Wilsonville Transportation System Plan, Parkway Avenue is classified as a Minor Arterial. Figure 3-7 shows a typical cross section for minor arterial street has at least 73' of ROW. Measured from the centerline of Parkway Ave, the 6.5' wide dedicated ROW will allow for 36.5' of ROW. The ROW dedication location was provided by the City Engineer in the Pre-Application Meeting and Notes.

As shown on Exhibit A, sheet C0 Existing Conditions Plan, the current right-of-way from west to east is composed of a 6' curb tight sidewalk, a 5' bike lane, 12.5' travel lane, 13' center turn lane, 12.5' travel lane, 5' bike lane, and 6' curb tight sidewalk.

Existing curb tight sidewalk along this project frontage matches the condition to the north and south of this project and on the opposite side of the street. The existing curb tight sidewalk is also being retained to prevent any disturbance to the root protection zone of the Heritage Tree.

Therefore, this standard is met.

**C. Rights-of-way:**

- 1. Prior to issuance of a Certificate of Occupancy Building permits or as a part of the recordation of a final plat, the City shall require dedication of rights-of-way in accordance with the Transportation System Plan. All dedications shall be recorded with the County Assessor's Office.*
- 2. The City shall also require a waiver of remonstrance against formation of a local improvement district, and all non-remonstrances shall be recorded in the County Recorder's Office as well as the City's Lien Docket, prior to issuance of a Certificate of Occupancy Building Permit or as a part of the recordation of a final plat.*
- 3. In order to allow for potential future widening, a special setback requirement shall be maintained adjacent to all arterial streets. The minimum setback shall be 55 feet from the centerline or 25 feet from the right-of-way designated on the Master Plan, whichever is greater.*

**Response:** As stated above, the proposed development includes a dedication of 6.5' of ROW along Parkway Avenue as required by the Transportation System Plan. Therefore, this standard is met.

*D. Dead-end Streets. New dead-end streets or culs-de-sac shall not exceed 200 feet in length, unless the adjoining land contains barriers such as existing buildings, railroads or freeways, or environmental constraints such as steep slopes, or major streams or rivers, that prevent future street extension and connection. A central landscaped island with rainwater management and infiltration are encouraged in cul-de-sac design. No more than 25 dwelling units shall take access to a new dead-end or cul-de-sac street unless it is determined that the traffic impacts on adjacent streets will not exceed those from a development of 25 or fewer units. All other dimensional standards of dead-end streets shall be governed by the Public Works Standards. Notification that the street is planned for future extension shall be posted on the dead-end street.*

**Response:** No dead-end streets are proposed with this development. Therefore, this standard does not apply.

*E. Corner or clear vision area:*

- 1. A clear vision area which meets the Public Works Standards shall be maintained on each corner of property at the intersection of any two streets, a street and a railroad or a street and a driveway. However, the following items shall be exempt from meeting this requirement:
  - a. Light and utility poles with a diameter less than 12 inches.*
  - b. Trees less than six inch d.b.h., approved as a part of the Stage II Site Design, or administrative review.*
  - c. Except as allowed by b., above, an existing tree, trimmed to the trunk, ten feet above the curb.*
  - d. Official warning or street sign.*
  - e. Natural contours where the natural elevations are such that there can be no cross-visibility at the intersection and necessary excavation would result in an unreasonable hardship on the property owner or deteriorate the quality of the site.**

**Response:** This property is not a corner lot, street intersection or railroad crossing. The Site Development Plan, sheet C1 (Exhibit A) shows the clear vision area for the two driveways. The clear vision areas meets requirements of the Public Works Standards. Therefore, this standard is met.

*F. Vertical clearance. A minimum clearance of 12 feet above the pavement surface shall be maintained over all streets and access drives.*

**Response:** As shown in the Site Development Plan, sheet C1 (Exhibit A) a 12' vertical clearance is provided over both access drives. No structures are proposed over the driveways. Therefore, this standard is met.

*G. Interim improvement standard. It is anticipated that all existing streets, except those in new subdivisions, will require complete reconstruction to support urban level traffic volumes. However, in most cases, existing and short-term projected traffic volumes do not warrant improvements to full Master Plan standards. Therefore, unless otherwise specified by the Development Review Board, the following interim standards shall apply.*

- 1. Arterials 24 foot paved, with standard sub-base. Asphalt overlays are generally considered unacceptable, but may be considered as an interim improvement based on the recommendations of the City Engineer, regarding adequate structural quality to support an overlay.*
- 2. Half-streets are generally considered unacceptable. However, where the Development Review Board finds it essential to allow for reasonable development, a half-street may be approved. Whenever a half-street improvement is approved, it shall conform to the requirements in the Public Works Standards:*
- 3. When considered appropriate in conjunction with other anticipated or scheduled street improvements, the City Engineer may approve street improvements with a single asphalt lift. However, adequate provision must be made for interim storm drainage, pavement transitions at seams and the scheduling of the second lift through the Capital Improvements Plan.*

**Response:** No new streets or half-streets are proposed with this development.

*(.03) Sidewalks. Sidewalks shall be provided on the public street frontage of all development. Sidewalks shall generally be constructed within the dedicated public right-of-way, but may be located outside of the right-of-way within a public easement with the approval of the City Engineer.*

*A. Sidewalk widths shall include a minimum through zone of at least five feet. The through zone may be reduced pursuant to variance procedures in Section 4.196, a waiver pursuant to Section 4.118, or by authority of the City Engineer for reasons of traffic operations, efficiency, or safety.*



**Response:** As shown in the Existing Conditions (Exhibit A, Sheet C0,0), an existing 5-foot sidewalk is provided along Parkway Avenue and will remain with the new development. Existing curb tight sidewalk along this project frontage matches the condition to the north and south of this project and on the opposite side of the street. The existing curb tight sidewalk is also being retained to prevent any disturbance to the root protection zone of the Heritage Tree. This standard is met.

*B. Within a Planned Development, the Development Review Board may approve a sidewalk on only one side. If the sidewalk is permitted on just one side of the street, the owners will be required to sign an agreement to an assessment in the future to construct the other sidewalk if the City Council decides it is necessary.*

**Response:** The property is not within a planned development. This standard is not applicable.

*(.04) Bicycle Facilities. Bicycle facilities shall be provided to implement the Transportation System Plan, and may include on-street and off-street bike lanes, shared lanes, bike boulevards, and cycle tracks. The design of on-street bicycle facilities will vary according to the functional classification and the average daily traffic of the facility.*

**Response:** No bike facilities are proposed or required with this development. Bike lanes ADD DIAMENTION are already present on SW Parkway Avenue on the project frontage. The bike lanes are shown on the Site Development Plan, sheet C1 (Exhibit A). The Traffic Memo, signed by the City, states that no additional street improvements along the project frontage on SW Parkway Avenue will be required of the project applicant. Therefore, this standard is met.

*(.05) Multiuse Pathways. Pathways may be in addition to, or in lieu of, a public street. Paths that are in addition to a public street shall generally run parallel to that street, and shall be designed in accordance with the Public Works Standards or as specified by the City Engineer. Paths that are in lieu of a public street shall be considered in areas only where no other public street connection options are feasible, and are subject to the following standards.*

*A. Paths shall be located to provide a reasonably direct connection between likely pedestrian and bicyclist destinations. Additional standards relating to entry points, maximum length, visibility, and path lighting are provided in the Public Works Standards.*

**Response:** No multiuse pathways are proposed. Therefore, this standard does not apply.

*(.06) Transit Improvements. Development on sites that are adjacent to or incorporate major transit streets shall provide improvements as described in this section to any bus stop located*



*along the site's frontage, unless waived by the City Engineer for reasons of safety or traffic operations. Transit facilities include bus stops, shelters, and related facilities. Required transit facility improvements may include the dedication of land or the provision of a public easement.*

*A. Development shall at a minimum provide:*

- 1. Reasonably direct pedestrian connections, as defined by Section 4.154, between building entrances and the transit facility and between buildings on the site and streets adjoining transit stops.*
- 2. Improvements at major transit stops. Improvements may include intersection or mid-block traffic management improvements to allow for pedestrian crossings at major transit stops.*

**Response:** No transit facilities are located adjacent to the property or proposed. Therefore, this standard does not apply.

*B. Developments generating an average of 49 or more pm peak hour trips shall provide bus stop improvements per the Public Works Standards. Required improvements may include provision of benches, shelters, pedestrian lighting; or provision of an easement or dedication of land for transit facilities.*

**Response:** As described in the Traffic Memo (Exhibit F), the proposed use is an electrical substation that is expected to generate an average of no daily or PM peak hour vehicle trips as the site will contain electrical equipment only and no office space or other trip generating land uses. Therefore, this standard does not apply.

*C. In addition to the requirements of 4.177(.06)(A.)(2.), development generating more than 199 pm peak hour trips on major transit streets shall provide a bus pullout, curb extension, and intersection or mid-block traffic management improvements to allow for pedestrian crossings at major transit stops.*

**Response:** As stated above, the development will generate no trips during peak hours. Therefore, this standard does not apply.

*(.08) Access Drive and Driveway Approach Development Standards:*

*A. An access drive to any proposed development shall be designed to provide a clear travel lane free from any obstructions.*

**Response:** As shown in the Site Development Plan (Exhibit A), there are two driveway access lanes that are 30- feet wide and provide a clear travel lane free of obstructions. Therefore, this standard is met.

*B. Access drive travel lanes shall be constructed with a hard surface capable of carrying a 23-ton load.*

**Response:** The proposed driveways will be standard asphalt pavement. Therefore, this standard is met.

*C. Where emergency vehicle access is required, approaches and driveways shall be designed and constructed to accommodate emergency vehicle apparatus and shall conform to applicable fire protection requirements. The City may restrict parking, require signage, or require other public safety improvements pursuant to the recommendations of an emergency service provider.*

**Response:** Emergency vehicle access on to the site is not required. The proposed driveways will be able to accommodate any emergency vehicles and PGE response vehicles that need to access the site. Therefore, this standard is met.

*D. Secondary or emergency access lanes may be improved to a minimum 12 feet with an all-weather surface as approved by the Fire District. All fire lanes shall be dedicated easements.*

**Response:** No secondary access lanes or emergency access lanes are proposed with this development.

*E. Minimum access requirements shall be adjusted commensurate with the intended function of the site based on vehicle types and traffic generation.*

**Response:** The proposed land use of the site is an electrical substation. No adjustment to minimum access requirements is necessary with this development. Therefore, this standard is met.

*F. The number of approaches on higher classification streets (e.g., collector and arterial streets) shall be minimized; where practicable, access shall be taken first from a lower classification street.*

**Response:** Parkway Avenue is the only street to access the property. A Traffic Memo (Exhibit F) has been produced by the City of Wilsonville evaluating the impact of the proposed development on the transportation system and an evaluation of the proposed access points (driveways). The development will have two new access driveways along SW Parkway Avenue that will be gated. SW Parkway Avenue is classified as a minor arterial. The driveways are 30 feet wide standard asphalt pavement. The location of the driveways allows the safest and most convenient access to the site for PGE or emergency personnel. The substation will not be accessible to public vehicles or pedestrians. The volume of vehicles accessing the driveway is extremely low, once or twice a month, with no daily trips during peak hours. The analysis in the Traffic Memo concludes that because the project site generates such a low volume of vehicle trips (see Vehicle Trip Generation), the currently proposed access locations and spacings are not a safety concern as proposed on the site plan. However, an exception or variance to the City's Public Works Construction Standards will be required. See Exhibit K. Therefore, this standard is met.

*G. The City may limit the number or location of connections to a street, or impose access restrictions where the roadway authority requires mitigation to alleviate safety or traffic operations concerns.*

**Response:** No traffic or safety concerns have been identified by the roadway authority. A Traffic Memo (Exhibit F) is submitted with this application. The Traffic Memo concludes that because the project site generates such a low volume of vehicle trips (see Vehicle Trip Generation in Traffic Memo), the proposed access locations and spacings are not a safety concern as currently proposed on the site plan. Therefore, this standard is met.

*H. The City may require a driveway to extend to one or more edges of a lot and be designed to allow for future extension and inter-lot circulation as adjacent properties develop. The City may also require the owner(s) of the subject site to record an access easement for future joint use of the approach and driveway as the adjacent property(ies) develop(s).*

**Response:** No new access easements are required or proposed with this development. Therefore, this standard does not apply.

*I. Driveways shall accommodate all projected vehicular traffic on-site without vehicles stacking or backing up onto a street.*

**Response:** The onsite circulation and two driveway access aisles will allow for any vehicles entering the site to exit without backing up onto the street. One vehicle is expected to access the site at a time.

*J. Driveways shall be designed so that vehicle areas, including but not limited to drive-up and drive-through facilities and vehicle storage and service areas, do not obstruct any public right-of-way.*

**Response:** As shown on the Site Development Plan (Exhibit A, Sheet C.1), no portion of the driveway will be used for parking, vehicle storage, or as a service area. The driveways will not create any obstructions to the public right-of-way. Therefore, this standard is met.

*K. Approaches and driveways shall not be wider than necessary to safely accommodate projected peak hour trips and turning movements, and shall be designed to minimize crossing distances for pedestrians.*

**Response:** The proposed driveways are 30 feet' wide to accommodate any service vehicles visiting the site. As stated above, no trips will be generated by this use and little to no pedestrian traffic is expected. Therefore, this standard is met.

*L. As it deems necessary for pedestrian safety, the City, in consultation with the roadway authority, may require traffic-calming features, such as speed tables, textured driveway surfaces, curb extensions, signage or traffic control devices, or other features, be installed on or in the vicinity of a site.*

**Response:** No traffic-calming features are expected to be necessary with this request. Please see the Traffic Memo (Exhibit F). Therefore, this standard does not apply.

*M. Approaches and driveways shall be located and designed to allow for safe maneuvering in and around loading areas, while avoiding conflicts with pedestrians, parking, landscaping, and buildings.*

**Response:** The two driveways will be gated and locked except for PGE employees who occasionally service the substation. The driveways are located and designed to allow for PGE vehicles to maneuver through the site by entering one gate and exiting the other without having to turn around. No pedestrians, parking, landscaping or buildings are located inside the perimeter fence. Therefore, this standard is met.

*N. Where a proposed driveway crosses a culvert or drainage ditch, the City may require the developer to install a culvert extending under and beyond the edges of the driveway on both sides of it, pursuant applicable Public Works standards.*

**Response:** The proposed driveways do not cross a culvert or drainage ditch. Therefore, this standard does not apply.

*O. Except as otherwise required by the applicable roadway authority or waived by the City Engineer, temporary driveways providing access to a construction site or staging area shall be paved or graveled to prevent tracking of mud onto adjacent paved streets.*

**Response:** As shown on the Grading and Utility Plan, Sheet C2 (Exhibit A) a construction entrance is proposed in the location of the new southern driveway. The construction entrance will be gravel and inlet protection and sediment fence or straw wattles are proposed. Therefore, this standard is met.

*P. Unless constrained by topography, natural resources, rail lines, freeways, existing or planned or approved development, or easements or covenants, driveways proposed as part of a residential or mixed-use development shall meet local street spacing standards and shall be constructed to align with existing or planned streets, if the driveway.*

**Response:** The proposed driveways are not a part of a residential or mixed-use development. Therefore, this standard does not apply.

### **Section 4.199 – Outdoor Lighting**

#### *Section 4.199.20. Applicability.*

*(.01) This Ordinance is applicable to:*

*A. Installation of new exterior lighting systems in public facility, commercial, industrial and multi-family housing projects with common areas.*

**Response:** Exterior lighting is being proposed as part of the substation for access and security. The substation is an industrial use. Therefore, Section 4.199 is applicable.

#### **Section 4.199.40. Lighting Systems Standards for Approval.**

*(.01) Non-Residential Uses and Common Residential Areas.*

*A. All outdoor lighting shall comply with either the Prescriptive Option or the Performance Option below.*

**Response:** The Substation lighting shall comply with the Performance option. See responses to 4.199.40.01.C below.

*C. Performance Option.* If the lighting is to comply with the Performance Option, the proposed lighting design shall be submitted by the applicant for approval by the City meeting all of the following:

1. The weighted average percentage of direct upright lumens shall be less than the allowed amount per Table 9.
2. The maximum light level at any property line shall be less than the values in Table 9, as evidenced by a complete photometric analysis including horizontal illuminance of the site and vertical illuminance on the plane facing the site up to the mounting height of the luminaire mounted highest above grade. The Building Official or designee may accept a photometric test report, demonstration or sample, or other satisfactory confirmation that the luminaire meets the shielding requirements of Table 7. Luminaires shall not be mounted so as to permit aiming or use in any way other than the manner maintaining the shielding classification required herein:
  - a. *Exception 1.* If the property line abuts a public right-of-way, including a sidewalk or street, the analysis may be performed across the street at the adjacent property line to the right-of-way.
  - b. *Exception 2.* If, in the opinion of the Building Official or designee, compliance is impractical due to unique site circumstances such as lot size or shape, topography, or size or shape of building, which are circumstances not typical of the general conditions of the surrounding area. The Building Official may impose conditions of approval to avoid light trespass to the maximum extent possible and minimize any additional negative impacts resulting to abutting and adjacent parcels, as well as public rights-of-way, based on best lighting practices and available lighting technology.
3. The maximum pole or mounting height shall comply with Table 8.

**Response:** The Substation lighting shall comply with the Performance option. Please see provided Lighting Study (Exhibit G) for reference. The study includes footcandle measurements for Area lighting and Task lighting. It also includes information on light fixtures and poles.

There are two lighting schemes within the Substation. The Area lighting scheme is used during normal modes of operation. Four Area lights are located on the control enclosure and two are located on the switchgear enclosure near enclosure doors. They are mounted at 8 feet from grade and come with shields to block upward light trespass. They are controlled by a photocell to ensure enough light for PGE crews to safely enter the station at night. The study shows less than .1 footcandles at the property line except for the South side which shows between .1 and .25 footcandles.

The Task lighting scheme includes the Area Lights along with lights mounted on 11 light poles located within the substation fence. Task lighting is only used under emergency circumstances and ensures that PGE crews have enough lighting to safely work on substation equipment. Task lights are controlled by switches located near entry gates and within the control enclosure. Light poles within the substation yard have lights mounted at 35' above grade. The lights are designed to illuminate equipment in the yard but are shielded to avoid upward light trespass. Side shields are also used to avoid horizontal trespass across the property line. The lighting study shows less than .5 foot candles at the property line when Area lights are on.

This standard is met.

D. *Curfew*. All prescriptive or performance based exterior lighting systems shall be controlled by automatic device(s) or system(s) that:

1. Initiate operation at dusk and either extinguish lighting one hour after close or at the curfew times according to Table 10; or
2. Reduce lighting intensity one hour after close or at the curfew time to not more than 50 percent of the requirements set forth in the Oregon Energy Efficiency Specialty Code unless waived by the DRB due to special circumstances; and
3. Extinguish or reduce lighting consistent with 1. and 2. above on Holidays.

The following are exceptions to curfew:

- a. *Exception 1*: Building Code required lighting.
- b. *Exception 2*: Lighting for pedestrian ramps, steps and stairs.
- c. *Exception 3*: Businesses that operate continuously or periodically after curfew.

**Response:** Requesting Exception 3 for lighting curfew requirements. PGE requests an exception to the curfew due to the necessity of safe substation access at any time of day. Area lights will automatically be controlled by photocell turning lights on at dusk and off at dawn. Task lights are not automatically controlled. This standard is met with exception 3c.

Section 4.199.50. - Submittal Requirements.

(.01) Applicants shall submit the following information as part of DRB review or administrative review of new commercial, industrial, multi-family or public facility projects:

- A. A statement regarding which of the lighting methods will be utilized, prescriptive or performance, and a map depicting the lighting zone(s) for the property.
- B. A site lighting plan that clearly indicates intended lighting by type and location. For adjustable luminaires, the aiming angles or coordinates shall be shown.

C. For each luminaire type, drawings, cut sheets or other documents containing specifications for the intended lighting including but not limited to, luminaire description, mounting, mounting height, lamp type and manufacturer, lamp watts, ballast, optical system/distribution, and accessories such as shields.

D. Calculations demonstrating compliance with Oregon Energy Efficiency Specialty Code, Exterior Lighting, as modified by Section 4.199.40(.01)(B.)(2.)

E. Lighting plans shall be coordinated with landscaping plans so that pole lights and trees are not placed in conflict with one another. The location of lights shall be shown on the landscape plan. Generally, pole lights should not be placed within one pole length of landscape and parking lot trees.

F. Applicants shall identify the hours of lighting curfew.

**Response:** Please see attached Lighting Study (Exhibit G) for Memorial Substation which will include items listed above. Exhibit G contains the Lighting Study, Photometric Plan and Cut Sheets. This standard is met.

(.02) In addition to the above submittal requirements, Applicants using the Prescriptive Method shall submit the following information as part of the permit set plan review:

**Response:** Not Applicable because the applicant proposed using the performance method.

(.03) In addition to the above submittal requirements, Applicants using the Performance Method shall submit the following information as part of the permit set plan review:

A. Site plan showing horizontal isocandle lines, or the output of a point-by-point computer calculation of the horizontal illumination of the site, showing property lines and light levels immediately off of the subject property.

B. For each side of the property, the output of a point-by-point vertical footcandle calculation showing illumination in the vertical plane at the property line from grade to at least ten feet higher than the height of the tallest pole.

C. Lighting plans shall be prepared by a qualified licensed engineer.

**Response:** Please see attached Lighting Study (Exhibit G) for compliance with A-C. This standard is met.



## **E. Conditional Use**

### **Section 4.184 – Conditional Use Permits**

*(.01) A. Authorization to Grant or Deny Conditional Uses: A conditional use listed in this ordinance shall be permitted, altered, or denied in accordance with the standards and procedures of this Section. In judging whether a conditional use permit shall be approved, or determining appropriate conditions of approval, the Development Review Board shall weigh the proposal's positive and negative features that would result from authorizing the particular development at a location proposed, and to approve such use, shall find that the following criteria are either met, can be met by observance of conditions, or are not applicable:*

*1. The proposal will be consistent with the provisions of the Comprehensive Plan and the requirements of [Chapter 4](#) of the Wilsonville Code and other applicable policies of the City.*

**Response:** As demonstrated in this narrative, the proposal is consistent with the requirements of Ch. 4 of the Wilsonville Code and other applicable policies of the City. The proposed development is consistent with the following provisions of the Comprehensive Plan:

- *Policy 3.1.13 The City of Wilsonville shall coordinate planning activities with the utility companies, to insure orderly and efficient installation of needed service lines and equipment.*

The applicant, a utility company, is working with the City of Wilsonville to expand service to serve the growth of the City of Wilsonville. The Wilsonville area is currently experiencing increases in electrical demand due to continuing residential growth as well as a number of new commercial and industrial facilities with substantial electrical supply needs. Currently, the Wilsonville region is served exclusively by the existing Coffee Creek and Wilsonville substations. No other substations currently exist within a reasonable distance to offset the load at these facilities. Additionally, the existing Wilsonville substation is not a candidate for expansion due to the limited space available at the current site. This has necessitated the development of a new substation to create additional capacity and serve the City. PGE is coordinating with Wilsonville to serve the City's growth and development.

*2. The characteristics of the site are suitable for the proposed use considering size, shape, design, location, topography, existence of improvements and natural features.*

**Response:** The site is currently vacant and adjacent to I-5 and a commercial use (garden center) and institutional use (church). The site is relatively flat and minimal grading will be necessary. A historic tree is present on the site that will be protected as shown in the Tree Preservation and Protection Plan (Exhibit A). The substation will be adequately screened with an 8-foot perimeter fence and high screen landscape to minimize potential visual and noise impacts. The substation will not produce noise above 68dB max with all fan stages on which means the noise produced will be a maximum normal conversation level. The location of the site is adjacent to Interstate 5, therefore any potential noise produced by the substation would not impact

adjacent sites (also adjacent to Interstate 5) greater than the noise produced by the existing freeway.

*3. All required public facilities and services exist, or will be provided, to adequately meet the needs of the proposed development.*

**Response:** As demonstrated in this narrative, all necessary public facilities for this use already exist on the site. Therefore, this standard is met.

*4. The proposed use will not alter the character of the surrounding area in a manner which substantially limits, or precludes the use of surrounding properties for the uses listed as permitted in the zone.*

**Response:** This proposal is not expected to alter the character of the surrounding properties or preclude the use of surrounding properties for their permitted uses. The substation is permitted as conditional use in the PDI zone and adequate landscaping, screening, and tree preservation that will minimize the substation's impact on the surrounding area.

*(.06) Conditional Use Regulations—Public Utility Structures.*

*A. Except as provided in this Section and Section 4.800, all transmission and public utility structures, including, but not limited to, distribution lines and poles, sub-transmission structures, lines and poles, double poles and steel towers for transmission lines, substations, automatic telephone exchanges, relay stations, microwave towers, satellite antennas, pumping stations and treatment plants shall be regulated as conditional uses in all zones.*

**Response:** This request is for an electrical substation, and we are requesting conditional use approval.

**F. Underground Utilities**

**Sections 4.310 - Exceptions**

*Section 4.300 of this Code shall not apply to surface-mounted transformers, surface-mounted connection boxes, wireless communication facilities, and meter cabinets and other appurtenances which are reasonably necessary to be placed above ground, or to temporary utility service facilities during construction, or to high capacity electric and communication feeder lines, or to utility transmission lines operating at 50,000 volts or more.*

**Response:** This proposal is for an electrical substation with ground mounted transformers and utility transmission lines operating at 50,000 volts or more. Therefore, this standard applies, and the proposal is exempt from underground utility requirements.

**Sections 4.320 - Requirements**

*(.01) The developer or subdivider shall be responsible for and make all necessary arrangements with the serving utility to provide the underground services (including cost of rearranging any existing overhead facilities). All such underground facilities as described shall be constructed in compliance with the rules and regulations of the Public Utility Commission of the State of Oregon relating to the installation and safety of underground lines, plant, system, equipment and apparatus.*

*(.02) The location of the buried facilities shall conform to standards supplied to the subdivider by the City. The City also reserves the right to approve location of all surface-mounted transformers.*

*(.03) Interior easements (back lot lines) will only be used for storm or sanitary sewers, and front easements will be used for other utilities unless different locations are approved by the City Engineer. Easements satisfactory to the serving utilities shall be provided by the developer and shall be set forth on the plat.*

**Response:** As stated above, this development is exempt from underground utility requirements. Therefore, this standard is met.

**G. Tree Preservation and Protection**

**Section 4.600.30. - Tree Removal Permit Required.**

*(.01) Requirement Established. No person shall remove any tree without first obtaining a Tree Removal Permit (TRP) as required by this subchapter.*

**Response:** No trees are being removed with this development as demonstrated on the Tree Table on the Tree Preservation and Protection Plan (Exhibit A). Therefore, no TRP is required.

**Section 4.620.10 – Tree Protection During Construction.**

*(.01) Where tree protection is required by a condition of development under Chapter 4 or by a Tree Maintenance and Protection Plan approved under this subchapter, the following standards apply:*

- A. All trees required to be protected must be clearly labeled as such.*
- B. Placing Construction Materials Near Tree. No person may conduct any construction activity likely to be injurious to a tree designated to remain, including, but not limited to, placing solvents, building material, construction equipment, or depositing soil, or placing irrigated landscaping, within the drip line, unless a plan for such construction activity has been approved by the Planning Director or Development Review Board based upon the recommendations of an arborist.*

- C. *Attachments to Trees During Construction. Notwithstanding the requirement of WC 4.620.10(1)(A), no person shall attach any device or wire to any protected tree unless needed for tree protection.*
- D. *Protective Barrier. Before development, land clearing, filling or any land alteration for which a Tree Removal Permit is required, the developer shall erect and maintain suitable barriers as identified by an arborist to protect remaining trees. Protective barriers shall remain in place until the City authorizes their removal or issues a final certificate of occupancy, whichever occurs first. Barriers shall be sufficiently substantial to withstand nearby construction activities. Plastic tape or similar forms of markers do not constitute "barriers." The most appropriate and protective barrier shall be utilized. Barriers are required for all trees designated to remain, except in the following cases:*
- 1) *Rights-of-Way and Easements. Street right-of-way and utility easements may be cordoned by placing stakes a minimum of 50 feet apart and tying ribbon, plastic tape, rope, etc., from stake to stake along the outside perimeters of areas to be cleared.*
  - 2) *Any property area separate from the construction or land clearing area onto which no equipment will venture may also be cordoned off as described in paragraph (D) of this subsection, or by other reasonable means as approved by the reviewing authority.*

**Response:** As shown in the Tree Preservation and Protection Plan (Exhibit A), the Heritage Tree on site will be protected during construction with a 6-foot chain-link fence. The protective fence location was determined by the Arborist's report (Exhibit D), which recommends a barrier fence around the root protection zone. No construction materials will be placed inside the fence. Trees 5520 and 5521 (10" and 14" Hawthorn, trunks located on ODOT Property) will likely have some root and crown encroachment on PGE property due to construction but are anticipated to remain. Tree protection measures meeting the Performance Path Requirements listed in the Arborists Report will be put in place to protect tree health for 5520 and 5521. All other trees are off site, the majority of which are not implicated by the development of the substation but will be protected to meet Prescriptive Path Requirements.

## H. Definition of Terms

### *Section 4.001 – Definition of Terms*

**Response:** This application uses and recognizes the definition of terms identified in Wilsonville's Development Code.

## **V. Conclusion**

As demonstrated in the findings above, the proposed substation meets the applicable Conditional Use and Site Design Review requirements that are applicable to the development.



---

Planning Department  
City of Wilsonville  
29799 SW Town Center Loop E  
Wilsonville, OR 97070

July 24, 2023

**RE: 27601 SW Parkway Ave. - Off Site Tree Assessment**

Dear Planner,

I am writing to address the potential impact of our development and construction activities on off-site trees near the property located at 27601 SW Parkway Ave. As part of our due diligence and in response to your request, we have conducted an additional assessment, taking into account the neighboring.

Upon observation, I have identified approximately fifteen small diameter trees to the south of the development site at 27755 SW Parkway Ave. These trees are situated in an irrigated planter bed and are isolated from the primary construction area by a significant distance of at least forty feet. It has been determined that no root impact is likely and as a result, no special protections are necessary for these trees.

Similarly, there are nine small diameter trees located at 27501 SW Parkway Ave to the north of the site. Based on current plans and the size and location of the trees, there is no expectation that development activities will impact the root zone or have any deleterious effect on the trees. As a result, no protection measures are deemed necessary.

In reviewing Section 4.600, Planning and Land Development (Tree Preservation and Protection), of the Wilsonville City Code, I have not identified any specific requirements or guidance pertaining to the protection of adjacent off-site trees. While I fully acknowledge the importance of tree preservation and often recommend protection of off-site trees, in this case, due to the location of the trees in proximity to the development site and the lack of specific requirements in the City Code, no protection appears to be required. Nevertheless, we will continue to exercise due diligence in construction practices and materials placement to ensure the least possible disruption to neighboring trees.

Thank you for your consideration in this matter. If you require any further information or have additional concerns, please do not hesitate to reach out.

Integrated Arboricultural Solutions  
P.O. Box 68012  
Portland, OR 97267  
(971) 335-1414  
[chris@integratedarbsolutions.com](mailto:chris@integratedarbsolutions.com)



---

A handwritten signature in black ink, appearing to read "Chris Whitman". The signature is fluid and cursive, with a long horizontal stroke at the end.

Chris Whitman

Board Certified Master Arborist

ISA # WE-10291BU, TRAQ

Integrated Arboricultural Solutions

P.O. Box 68012

Portland, OR 97267

(971) 335-1414

[chris@integratedarbsolutions.com](mailto:chris@integratedarbsolutions.com)

May 24, 2023

# PORTLAND GENERAL ELECTRIC

---

## Memorial Substation *Photometric Analysis Report* Rev A

**PROJECT NUMBER:**

0239542

**PROJECT CONTACT:**

ANDREW LARSON, P.E.

**EMAIL:**

ANDREW.LARSON@POWERENG.COM

**PHONE:**

503-892-6765





# PHOTOMETRIC ANALYSIS REPORT

**PREPARED FOR:**  
PORTLAND GENERAL ELECTRIC

**PREPARED BY:**  
JACOB OHONICH – (503) 892-6706 – JACOB.OHONICH@POWERENG.COM

REVISION HISTORY						
REV.	ISSUE DATE	ISSUED FOR	PREP BY	CHKD BY	APPD BY	NOTES
A	2023-05-23	Permit	JJO	AJG		Issued for Land Use Permit

**“Issued For” Definitions:**

- “Permit” means this document is issued for preliminary permit review, not for implementation
- “Prelim” means this document is issued for preliminary review, not for implementation
- “Appvl” means this document is issued for review and approval, not for implementation
- “Impl” means this document is issued for implementation
- “Record” means this document is issued after project completion for project file

# 1 DESIGN CRITERIA

The PGE Memorial Substation outdoor lighting system was designed per PGE Standard S13710 - Yard Design for Substations Rev.1.

PGE Substation lighting systems are comprised of two operating conditions, Area Lighting, and Task Lighting.

- I. Normal operation: Lighting is intended to provide basic illumination for operators navigating the substation at night. Lighting under normal operation will consist of the following:
  - a. Photocell controlled lights on the Control Enclosure, and Switchgear only.
- II. Emergency Operation: Lighting is intended to provide a higher level of illumination for the purpose of observing high-voltage equipment at night. Area and Task Lighting is switched on at the gate or at lighting control panel inside the control house by personnel as needed for maintenance or observation purposes.
- III. The Area and Task Lighting illumination for Memorial Substation under emergency operation will be defined as the following:
  - a. Grade (0')
    - i. Inside the fence: 0.5 to 1.0 foot-candles
    - ii. At the property lines: 0.5 foot-candles
  - b. Disconnect switch operators (3'): 2.0 foot-candles
  - c. Disconnect switch blades: 2.0 foot-candles
    - i. 115kV "Low" Disconnect switch blades: 14'
    - ii. 115kV "High" Disconnect switch blades: 21'
    - iii. 115kV A-frame-mounted Disconnect switch blades: 28'

# 2 PERMITTING

Memorial Substation is within the City of Wilsonville's Lighting Overlay Zone. PGE has requested to follow the Performance option under section 4.199.40.

- I. Design Criteria:
  - a. Lightings levels for LZ2 per section 4.199.40.03.C(2) table 9:
    - i. 0.5 foot-candles in the Horizontal plane
    - ii. 0.4 foot-candles in the Vertical plane
  - b. Vertical plane height requirement per section 4.199.50.03 (b) shall be forty-five feet, which is ten feet higher then the height of the fiberglass poles.

# 3 SITE LAYOUT – SEE DRAWING ONE NEXT PAGE

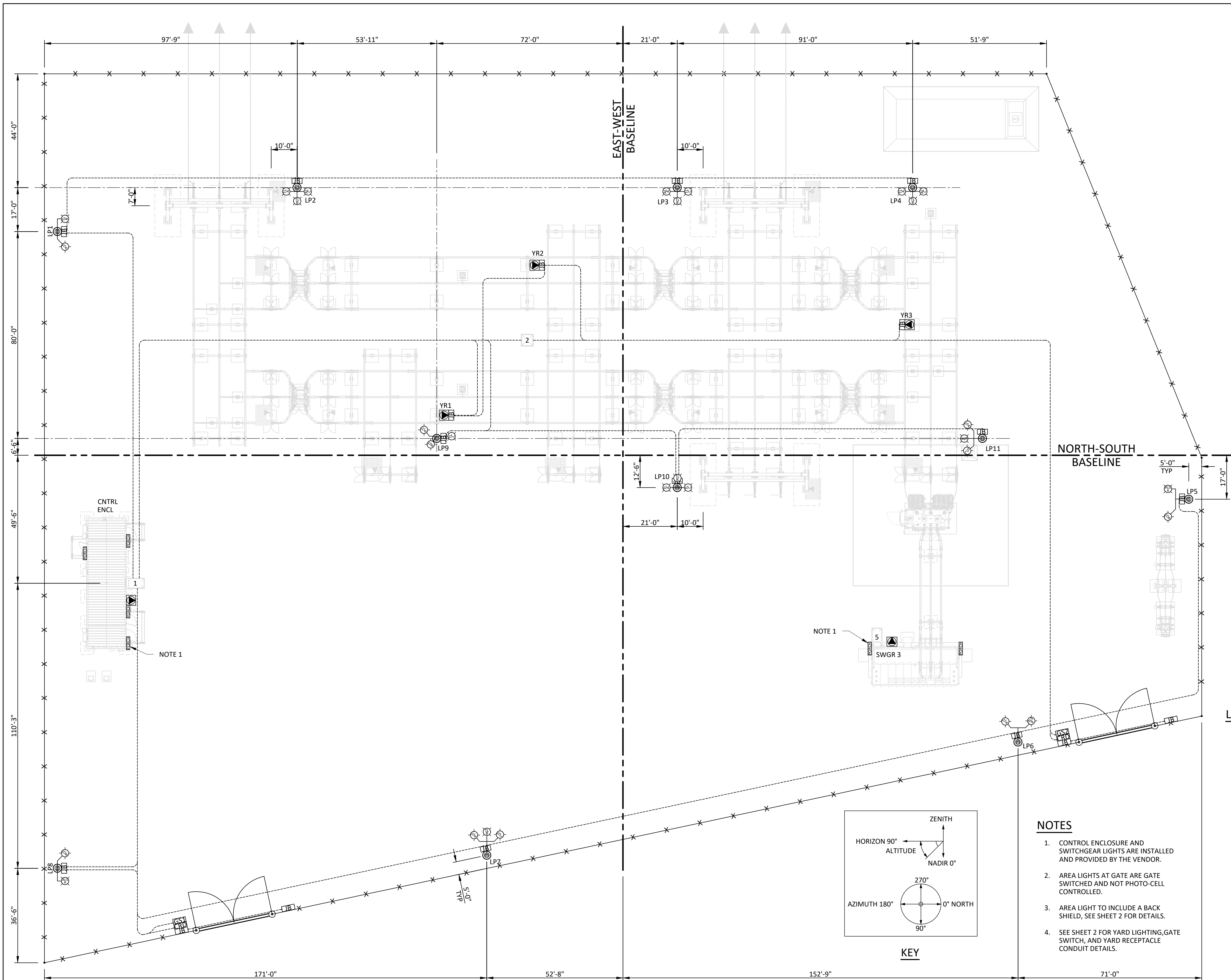

LIGHTING TABLE						
POLE	LIGHT	MODEL #	ALTITUDE	AZIMUTH	MOUNTING HEIGHT	LIGHTING GROUP
LP1	A	TASK LIGHT EFME-01CCT-3740NA-S1-DKBZ	60° BELOW HORIZON	45°	36'	1
LP1	B	TASK LIGHT EFME-01CCT-3740NA-S1-DKBZ	60° BELOW HORIZON	0°	36'	1
LP2	A	TASK LIGHT EFME-01CCT-3740NA-S1-DKBZ	60° BELOW HORIZON	180°	36'	1
LP2	B	TASK LIGHT EFME-01CCT-3740NA-S1-DKBZ	60° BELOW HORIZON	90°	36'	1
LP2	C	AREA LIGHT GE EALS-030F4-AF740ND-S1-DKBZ	90° BELOW HORIZON	0°	36'	1
LP3	A	AREA LIGHT GE EALS-030F4-AF740ND-S1-DKBZ	90° BELOW HORIZON	180°	36'	1
LP3	B	TASK LIGHT EFME-01CCT-3740NA-S1-DKBZ	60° BELOW HORIZON	90°	36'	1
LP3	C	TASK LIGHT EFME-01CCT-3740NA-S1-DKBZ	60° BELOW HORIZON	0°	36'	1
LP4	A	TASK LIGHT EFME-01CCT-3740NA-S1-DKBZ	60° BELOW HORIZON	180°	36'	1
LP4	B	TASK LIGHT EFME-01CCT-3740NA-S1-DKBZ	60° BELOW HORIZON	90°	36'	1
LP4	C	AREA LIGHT GE EALS-030F4-AF740ND-S1-DKBZ	90° BELOW HORIZON	0°	36'	1
LP5	A	AREA LIGHT GE EALS-030F4-AF740ND-S1-DKBZ	90° BELOW HORIZON	180°	36'	2
LP5	B	TASK LIGHT EFME-01CCT-3740NA-S1-DKBZ	60° BELOW HORIZON	135°	36'	2
LP6	A	TASK LIGHT EFME-01CCT-3740NA-S1-DKBZ	60° BELOW HORIZON	225°	36'	2
LP6	B	AREA LIGHT GE EALS-030F4-AF740ND-S1-DKBZ	90° BELOW HORIZON	315°	36'	2
LP7	A	TASK LIGHT EFME-01CCT-3740NA-S1-DKBZ	60° BELOW HORIZON	225°	36'	2
LP7	B	TASK LIGHT EFME-01CCT-3740NA-S1-DKBZ	60° BELOW HORIZON	270°	36'	2
LP7	C	TASK LIGHT EFME-01CCT-3740NA-S1-DKBZ	60° BELOW HORIZON	315°	36'	2
LP8	A	AREA LIGHT GE EALS-030F4-AF740ND-S1-DKBZ	90° BELOW HORIZON	0°	36'	2
LP8	B	TASK LIGHT EFME-01CCT-3740NA-S1-DKBZ	60° BELOW HORIZON	315°	36'	2
LP9	A	TASK LIGHT EFME-01CCT-3740NA-S1-DKBZ	60° BELOW HORIZON	225°	36'	3
LP9	B	TASK LIGHT EFME-01CCT-3740NA-S1-DKBZ	60° BELOW HORIZON	135°	36'	3
LP9	C	TASK LIGHT EFME-01CCT-3740NA-S1-DKBZ	60° BELOW HORIZON	0°	36'	3
LP10	A	TASK LIGHT EFME-01CCT-3740NA-S1-DKBZ	60° BELOW HORIZON	180°	36'	3
LP10	B	TASK LIGHT EFME-01CCT-3740NA-S1-DKBZ	60° BELOW HORIZON	270°	36'	3
LP10	C	TASK LIGHT EFME-01CCT-3740NA-S1-DKBZ	60° BELOW HORIZON	0°	36'	3
LP11	A	TASK LIGHT EFME-01CCT-3740NA-S1-DKBZ	60° BELOW HORIZON	225°	36'	3
LP11	B	TASK LIGHT EFME-01CCT-3740NA-S1-DKBZ	60° BELOW HORIZON	180°	36'	3
LP11	C	TASK LIGHT EFME-01CCT-3740NA-S1-DKBZ	60° BELOW HORIZON	160°	36'	3

**LEGEND:**

- CENTER LINE
- - - CONDUIT TERMINATED AT OR ABOVE GRADE
- FENCE
- ▭ FOUNDATION ABOVE GRADE
- - - FOUNDATION BELOW GRADE
- LG1 LG3 LIGHTING CIRCUIT(S)
- OIL CONTAINMENT LINER
- - - STATION BASELINE
- ⊠ CONDUIT VAULT WITH NUMBER
- ⊠ CRD CARD READER WITH RISER
- ⊠ GS# GATE SWITCH - 3 OR 4 WAY WITH CONDUIT RISER
- ⊠ JB JUNCTION BOX WITH CONDUIT RISER(S)
- ⊠ SJ# JUNCTION BOX FOR SECURITY WITH CONDUIT RISER(S)
- YR # JUNCTION BOX FOR 50A RECEPTACLE WITH CONDUIT RISER(S)
- LP # LIGHT POLE WITH NUMBER
- ⊠ AL AREA LIGHT
- ⊠ ALS AREA LIGHT W/ SHIELD
- ⊠ TL TASK LIGHT
- ⊠ PORCH PHOTO-CELL CONTROLLED ENCLOSURE DOOR LIGHTS

**NOTES**

1. CONTROL ENCLOSURE AND SWITCHGEAR LIGHTS ARE INSTALLED AND PROVIDED BY THE VENDOR.
2. AREA LIGHTS AT GATE ARE GATE SWITCHED AND NOT PHOTO-CELL CONTROLLED.
3. AREA LIGHT TO INCLUDE A BACK SHIELD, SEE SHEET 2 FOR DETAILS.
4. SEE SHEET 2 FOR YARD LIGHTING, GATE SWITCH, AND YARD RECEPTACLE CONDUIT DETAILS.

NOTE 3  
NOTES 2 & 3  
NOTES 2 & 3

DRAWN/ISSUE/ENGR./CHK./APPD.	PEI/JCO/AFL/PNK				
REVISION DESCRIPTION	REVISION DESCRIPTION	REVISION DESCRIPTION	REVISION DESCRIPTION	REVISION DESCRIPTION	REVISION DESCRIPTION
REV.	DATE	DATE	DATE	DATE	DATE
0	05-23-23	05-23-23	05-23-23	05-23-23	05-23-23
ORIGINAL ISSUE: AWO 1000009925 (CREATED USING MSTR-4400-1 REV 1)					
<b>MEMORIAL SUBSTATION</b> <b>YARD LIGHTING &amp; RECEPTACLE PLAN</b>					
MMRL-4400	SHEET 1 OF 1	DISTR. CODE AG	SCALE 1" = 20'-0"	REV. 0	PNC

## 4 EQUIPMENT

The luminaires used within the substation shall be defined as follows:

- Area lights: GE EALS-030F4AF740ND-S1-DKBZ
  - Back Shield for area lights at perimeter: GE EAL-RBL-BLCK
- Task Lights: GE EFM1-010CCT3740NA-S1-DKBZ
- Control Enclosure: RAB Lighting WPLED4T150N
- Switchgear: Hubbell PVL#-180L5K-U-DB

The luminaires shall be mounted on one of the following brackets with 2-3/8" Tenons in line:

- 2 Bracket: GE FBSB-2B2-TTGV
- 3 Bracket: GE FBSB-2C2-TTGV
- 4 Bracket: GE FBSB-2D2-TTGV

The luminaires and brackets shall be mounted on direct-embed fiberglass poles, with a 36' mounting height.

- Shakespeare BB41-02N2B101

## ROUND TAPERED COMPOSITE LIGHT POLE DIRECT BURIAL INSTALLATION

### SHAKESPEARE B-SERIES DIRECT BURIAL POLES

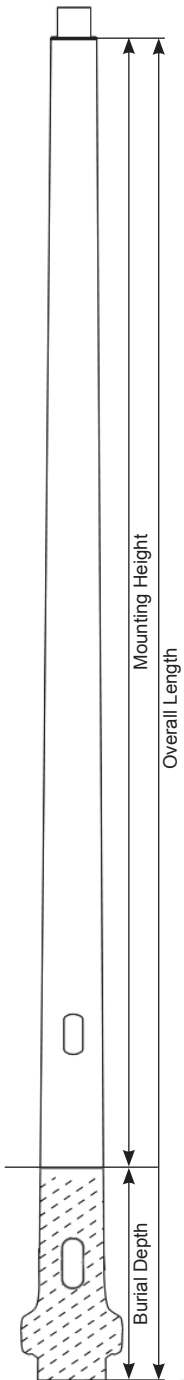

OVERALL LENGTH	MOUNTING HEIGHT	BURIAL DEPTH	TIP DIAMETER	GROUNDLINE DIAMETER	WEIGHT
24	20	4	6.4	8.9	132
25	21	4	6.4	9.1	137
26	22	4	6.4	9.2	142
27	23	4	6.4	9.4	148
28	24	4	6.4	9.5	153
30	25	5	6.4	9.6	158
31	26	5	6.4	9.8	163
32	27	5	6.4	9.9	168
33	28	5	6.4	10.0	173
34	29	5	6.4	10.2	177
35	30	5	6.4	10.3	183
37	31	6	6.4	10.5	187
38	32	6	6.4	10.6	191
39	33	6	6.4	10.7	196
40	34	6	6.4	10.9	200
41	35	6	6.4	11.0	205
43	36	7	6.4	11.1	213
44	37	7	6.4	11.3	220
45	38	7	6.4	11.4	236
46	39	7	6.4	11.6	261
47	40	7	6.4	11.7	287

- Mounting heights to 40 feet
- Smooth, semi-smooth or natural finish
- 3 standard and 5 special architectural colors available
- High performance UV and weather-resistant pigmented resin system with an additional pigmented polyurethane coating.
- Tenon top or Drilled and Capped
- Standard 2-1/2" x 5" handhole located 18" above grade
- Standard 2 EA - 2-1/2" x 6" wire access hole 24" below grade
- Anti-rotation flare structurally integrated into the pole base during manufacture
- Poles are individually identified with a permanent embossed tag located 9" from tip.
- Sleeved individually for shipment
- Lightweight, easy to install, saves money

### ORDERING INFORMATION

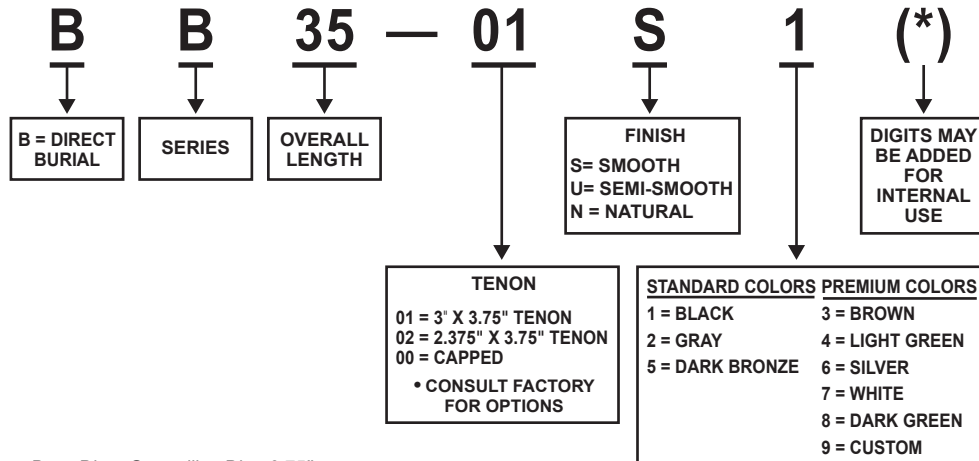

Base Dia. = Groundline Dia + 3.75"

# Accessories

## FLOOD LIGHTING BRACKETS FOR ALUMINUM POLES WITH PLATE MOUNT

Floodlighting bracket, aluminum, for mounting on aluminum poles, **plate mount only**. Bracket mounts multiple luminaires on 2-3/8-in. OD tenons.

Brackets Selection Table						
Number/ Placement Tenons	See Fig.	Ordering Number	Adjacent Tenon Spacing A (in)	Tenon Top OD (in)	Bracket Size	
					Weight (lbs)	EPA (sq ft)
2 in line	1a	FBAPB2TT	33	2-3/8	5	0.6
3 in line	1b	FBAPC2TT	33	2-3/8	8	1.1
4 in line	1c	FBAPD2TT	33	2-3/8	11	1.6
3 at 120°	1d	FBAPE2TT	41	2-3/8	10	0.7
4 at 90°	1e	FBAPF2TT	34	2-3/8	13	0.8

## LIGHTING CROSSARM BRACKETS

Sports lighting bracket, steel crossarm for mounting 2, 3, or 4 floodlights on wood poles.

Brackets Selection Table					
Number of Floodlights	See Fig.	Pole Material	Ordering Number	Bracket Size	
				Weight (lbs)	EPA (sq ft)
2	2	wood	SBSXBWPP	21	1.4
3	3	wood	SBSXCWPP	54	3.9
4	4	wood	SBSXDWPP	65	4.8

**NOTE:** If bracket is to be used for retrofitting an existing steel pole, substitute **S** for **W** in ordering number listed in Selection Table.

**NOTE:** All brackets are prime painted. For galvanized brackets, contact factory .

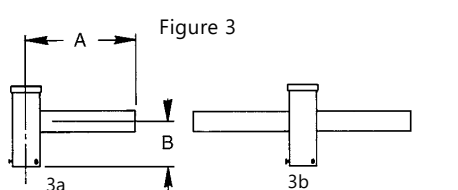
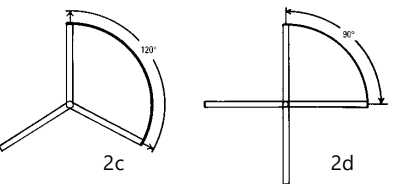
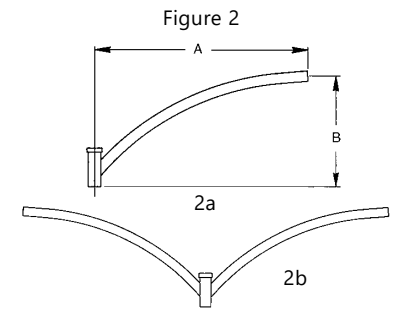
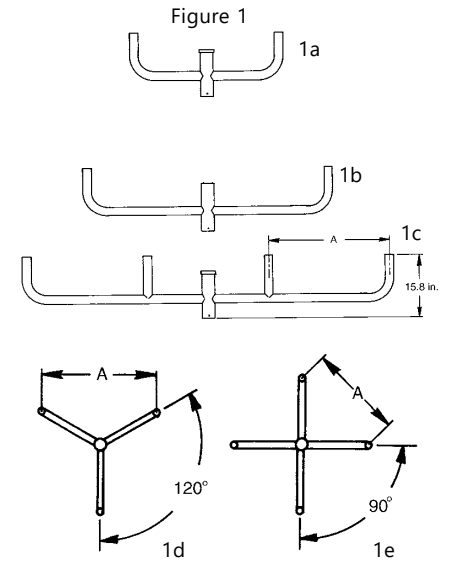
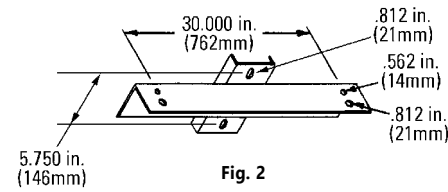
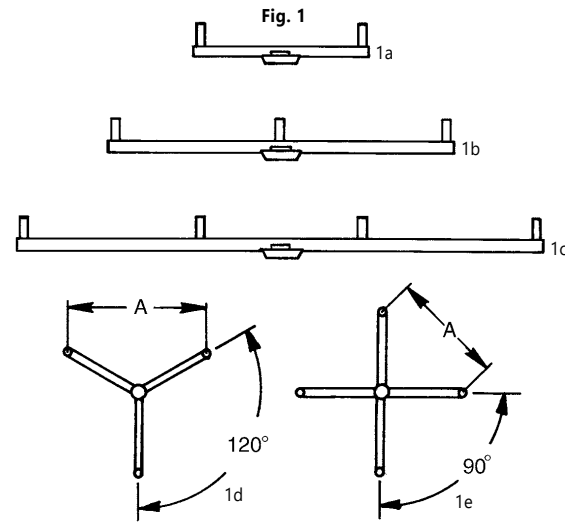
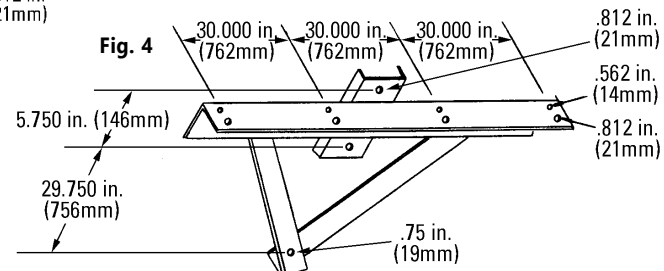
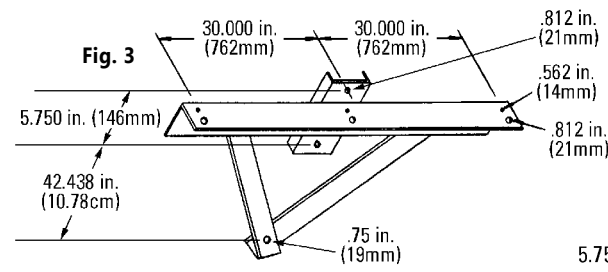

# Accessories

## FLOODLIGHTING BRACKETS, STEEL BULLHORN

Floodlighting bracket steel bullhorn for pole with 2-3/8 in. or 4 in. OD top tenon. Bracket has 2-3/8 in. top OD and is prime painted.

Brackets Selection Table								
Number/ Placement Tenons	See Fig.	Maximum Load Per Luminaire		Ordering Number	Adjacent Tenon Spacing A (in)	Luminaire Mounting OD (in)	Bracket Size	
		Max Weight (lbs)	Max EPA (sq ft)				Weight (lbs)	EPA (sq ft)
<b>Brackets T Fit Poles Having 2-3/8" OD Top Tenon</b>								
2 in line	1a	100	5.0	FBSB2B2TTPP	36	2-3/8	21	10.
3 in line	1b	100	3.8	FBSB2C2TTPP	30	2-3/8	32	1.6
4 in line	1c	100	3.0	FBSB2D2TTPP	30	2-3/8	44	2.3
3 at 120°	1d	100	3.8	FBSB2E2TTPP	41	2-3/8	34	1.3
4 at 90°	1e	100	3.0	FBSB2F2TTPP	34	2-3/8	44	1.6
<b>Brackets T Fit Poles Having 4" OD Top Tenon</b>								
3 in line	1b	125	6.0	FBSB4C2TTPP	36	2-3/8	37	1.9
4 in line	1c	125	6.0	FBSB4D2TTPP	36	2-3/8	67	2.6
3 at 120°	1d	125	6.0	FBSB4E2TTPP	41	2-3/8	38	1.5
4 at 90°	1e	125	6.0	FBSB4F2TTPP	34	2-3/8	48	1.6

**NOTE:** All brackets are prime painted. For galvanized brackets, substitute GV for PP in ordering number listed in Selection Table.

**NOTE:** Brackets may support more EPA and total weight than allowed by pole. Ensure the bracket and fixture loads do not exceed the pole limits.

## ROADWAY BRACKETS, STEEL UPSWEEP AND STRAIGHT FOR 2-3/8" OD POLE TOP TENONS

Floodlighting bracket steel bullhorn for pole with 2-3/8 in. or 4 in. OD top tenon. Bracket has 2-3/8 in. top OD and is prime painted.

Brackets Selection Table									
Number/ Placement Tenons	See Fig.	Bracket Dimensions		Maximum Load Per Luminaire		Ordering Number	LUMINAIRE MOUNTING OD (in)	Bracket Size	
		A (ft)	B (in)	Max Weight (lbs)	Max EPA (sq ft)			Weight (lbs)	EPA (sq ft)
<b>Steel Upsweep Bracket For 2-3/8" OD Top Tenon</b>									
1	2a	6	24	75	2.0	RBSU2H6PP	2-3/8	29	1.5
2 at 180°	2b	6	24	75	2.0	RBSU2J6PP	2-3/8	54	2.8
3 at 120°	2c	4	24	75	2.0	RBSU2K4PP	2-3/8	76	1.8
4 at 90°	2d	4	24	75	2.0	RBSU2L4PP	2-3/8	99	2.9
<b>Steel Straight Bracket For 2-3/8" OD Top Tenon</b>									
1	3a	2	5	125	6.0	RBSS2H2PP	2-3/8	12	0.6
2 at 180°	3b	2	5	125	6.0	RBSS2J2PP	2-3/8	18	1.0
3 at 120°	2c	2	5	125	6.0	RBSS2K2PP	2-3/8	26	1.0
4 at 90°	2d	2	5	125	6.0	RBSS2L2PP	2-3/8	32	1.4

**NOTE:** Brackets may support more EPA and total weight than allowed by pole. Ensure the bracket and fixture loads do not exceed the pole limits.



# Ordering Number Logic

## Evolve™ LED Area Light (EALS-03)



E ALS 03 7

PROD. ID	GENERATION	VOLTAGE	OPTICAL DISTRIBUTION CODE	CRI	CCT	DIMMING	CONTROLS	MOUNTING ARM	COLOR	OPTIONS
----------	------------	---------	---------------------------	-----	-----	---------	----------	--------------	-------	---------

**E** = Evolve  
**AL** = Area Light  
**S** = Standard

**03** = 3rd Generation

**0** = 120-277\*  
**1** = 120  
**2** = 208  
**3** = 240  
**4** = 277  
**5** = 480  
**D** = 347  
**H** = 347-480\*  
 \*Not available with Fusing.  
 Must choose a discreet voltage with F Option

**SM** = Symmetric Medium  
**SW** = Symmetric Wide  
**SH** = Symmetric High Angle  
**AF** = Asymmetric Forward  
**AH** = Asymmetric High Angle  
**AW** = Asymmetric Wide  
**AN** = Asymmetric Narrow/Auto

**7** = 70 (min)

**30** = 3000K  
**40** = 4000K  
**50** = 5000K  
 ◊Select 3000K CCT for IDA Approved units

**N** = Dimming thru PE receptacle  
**D** = External Dimming 18/2-3ft cable  
**X** = Non-dimmable\*  
 All constructions supplied with ANSI C136.41 7-pin Receptacle  
 \*Required for Cx Optical Codes. Not available for other optical codes.  
**Note:** Standard dimming 0-10V

**A** = ANSI 7-pin PE receptacle (no control)  
**D** = ANSI 7-pin PE receptacle with shorting cap provided  
**Note:** See accessories section on page 10 for PE Control ordering

**C1** = Integral Slipfitter for 1.25" - 2" Pipe (1.66in. OD - 2.378in. OD)\*  
**D1** = Universal Mounting Arm, fitted for round or square pole mounting\*\*  
**K1** = Knuckle Slipfitter for 1.9 in - 2.3in. OD Tenon\*\*\*  
**S1** = Knuckle Slipfitter for 2.3in. - 3.0in OD Tenon\*\*\*  
**V1** = Knuckle Wall Mount\*\*\*  
 \* Supplied with 3FT leads  
 \*\* Supplied with 3FT #14/3 power cable  
 \*\*\* Restricted Aiming Angle 0° to +45°

**GRAY** = Gray  
**BLCK** = Black  
**DKBZ** = Dark Bronze  
**WHITE** = White

**F** = Fusing  
**H** = Motion Sensor (Sensor Switch)  
**H2** = Motion Sensor (Daintree)  
**J** = cUL/Canada  
**L** = Tool-Less Entry  
**R** = Enhanced Surge Protection (10kV/5kA)  
**S1** = Rotated Left †  
**S2** = Rotated Right †  
**T** = Elevated Surge Protection (20kV/10kA)  
**U** = DALI dimming ^+  
**V** = 3-Position Terminal Block Y = Coastal Finish  
**XXX** = Special Options  
 \* Contact Manufacturer for availability  
 + Compatible with LightGrid 2.0 nodes  
 ^ Not compatible at 347-480V or with motion sensor control  
 † For aimed left or right light distribution orientation, as assembled in manufacturing. Not applicable for Symmetric Distributions.  
**Note:** H2 option not available at 370V-480V

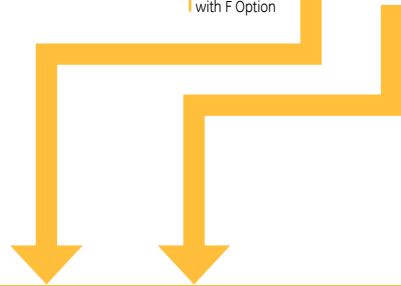

TYPE	OPTICAL CODE	DISTRIBUTION	TYPICAL INITIAL LUMENS		TYPICAL SYSTEM WATTAGE	BUG RATING		IES FILE NUMBER		
			3000K	4000K & 5000K	120-277V & 347-480V	3000K B-U-G	4000 & 5000K B-U-G	IES FILE NUMBER 3000K	IES FILE NUMBER 4000K	IES FILE NUMBER 5000K
Type V	C5	Symmetric Medium (SM)	7300	7500	46	B3-U0-G1	B3-U0-G1	EALS03_C5SM730_IES	EALS03_C5SM740_IES	EALS03_C5SM750_IES
	D5	Symmetric Medium (SM)	9800	10000	64	B3-U0-G1	B3-U0-G1	EALS03_D5SM730_IES	EALS03_D5SM740_IES	EALS03_D5SM750_IES
	F5	Symmetric Medium (SM)	14700	15000	101	B4-U0-G2	B4-U0-G2	EALS03_F5SM730_IES	EALS03_F5SM740_IES	EALS03_F5SM750_IES
	H5	Symmetric Medium (SM)	19600	20000	140	B4-U0-G2	B4-U0-G2	EALS03_H5SM730_IES	EALS03_H5SM740_IES	EALS03_H5SM750_IES
	J5	Symmetric Medium (SM)	24500	25000	186	B4-U0-G2	B4-U0-G2	EALS03_J5SM730_IES	EALS03_J5SM740_IES	EALS03_J5SM750_IES
	K5	Symmetric Medium (SM)	29400	30000	239	B5-U0-G3	B5-U0-G3	EALS03_K5SM730_IES	EALS03_K5SM740_IES	EALS03_K5SM750_IES
	C5	Symmetric Wide (SW)	7300	7500	46	B2-U0-G1	B2-U0-G1	EALS03_C5SW730_IES	EALS03_C5SW740_IES	EALS03_C5SW750_IES
	D5	Symmetric Wide (SW)	9800	10100	64	B3-U0-G1	B3-U0-G1	EALS03_D5SW730_IES	EALS03_D5SW740_IES	EALS03_D5SW750_IES
	F5	Symmetric Wide (SW)	14700	15100	101	B3-U0-G2	B4-U0-G2	EALS03_F5SW730_IES	EALS03_F5SW740_IES	EALS03_F5SW750_IES
	H5	Symmetric Wide (SW)	19700	20200	140	B4-U0-G2	B4-U0-G2	EALS03_H5SW730_IES	EALS03_H5SW740_IES	EALS03_H5SW750_IES
	J5	Symmetric Wide (SW)	24600	25200	186	B4-U0-G2	B4-U0-G2	EALS03_J5SW730_IES	EALS03_J5SW740_IES	EALS03_J5SW750_IES
	K5	Symmetric Wide (SW)	29600	30300	239	B5-U0-G2	B5-U0-G2	EALS03_K5SW730_IES	EALS03_K5SW740_IES	EALS03_K5SW750_IES
	C5	Symmetric High Angle (SH)	7000	7200	46	B3-U0-G1	B3-U0-G1	EALS03_C5SH730_IES	EALS03_C5SH740_IES	EALS03_C5SH750_IES
	D5	Symmetric High Angle (SH)	9400	9600	64	B3-U0-G2	B3-U0-G2	EALS03_D5SH730_IES	EALS03_D5SH740_IES	EALS03_D5SH750_IES
	F5	Symmetric High Angle (SH)	14200	14500	101	B4-U0-G2	B4-U0-G2	EALS03_F5SH730_IES	EALS03_F5SH740_IES	EALS03_F5SH750_IES
H5	Symmetric High Angle (SH)	18900	19300	140	B4-U0-G2	B4-U0-G2	EALS03_H5SH730_IES	EALS03_H5SH740_IES	EALS03_H5SH750_IES	
J5	Symmetric High Angle (SH)	23600	24100	186	B5-U0-G3	B5-U0-G3	EALS03_J5SH730_IES	EALS03_J5SH740_IES	EALS03_J5SH750_IES	
K5	Symmetric High Angle (SH)	28400	29000	239	B5-U0-G3	B5-U0-G3	EALS03_K5SH730_IES	EALS03_K5SH740_IES	EALS03_K5SH750_IES	
Type IV	C4	Asymmetric Forward (AF)	7300	7500	50	B1-U0-G2	B1-U0-G2	EALS03_C4AF730_IES	EALS03_C4AF740_IES	EALS03_C4AF750_IES
	D4	Asymmetric Forward (AF)	9800	10000	70	B2-U0-G2	B2-U0-G2	EALS03_D4AF730_IES	EALS03_D4AF740_IES	EALS03_D4AF750_IES
	F4	Asymmetric Forward (AF)	14700	15000	116	B2-U0-G2	B2-U0-G2	EALS03_F4AF730_IES	EALS03_F4AF740_IES	EALS03_F4AF750_IES
	H4	Asymmetric Forward (AF)	19600	20000	140	B3-U0-G3	B3-U0-G3	EALS03_H4AF730_IES	EALS03_H4AF740_IES	EALS03_H4AF750_IES
	J4	Asymmetric Forward (AF)	24500	25000	186	B3-U0-G3	B3-U0-G3	EALS03_J4AF730_IES	EALS03_J4AF740_IES	EALS03_J4AF750_IES
	K4	Asymmetric Forward (AF)	29400	30000	239	B3-U0-G4	B3-U0-G4	EALS03_K4AF730_IES	EALS03_K4AF740_IES	EALS03_K4AF750_IES
	C4	Asymmetric High Angle (AH)	7000	7200	50	B2-U0-G2	B2-U0-G2	EALS03_C4AH730_IES	EALS03_C4AH740_IES	EALS03_C4AH750_IES
	D4	Asymmetric High Angle (AH)	9400	9600	70	B2-U0-G2	B2-U0-G2	EALS03_D4AH730_IES	EALS03_D4AH740_IES	EALS03_D4AH750_IES
	F4	Asymmetric High Angle (AH)	14200	14500	116	B3-U0-G3	B3-U0-G3	EALS03_F4AH730_IES	EALS03_F4AH740_IES	EALS03_F4AH750_IES
	H4	Asymmetric High Angle (AH)	18900	19300	140	B3-U0-G3	B3-U0-G4	EALS03_H4AH730_IES	EALS03_H4AH740_IES	EALS03_H4AH750_IES
J4	Asymmetric High Angle (AH)	23600	24100	186	B3-U0-G4	B3-U0-G4	EALS03_J4AH730_IES	EALS03_J4AH740_IES	EALS03_J4AH750_IES	
K4	Asymmetric High Angle (AH)	28400	29000	239	B3-U0-G4	B3-U0-G4	EALS03_K4AH730_IES	EALS03_K4AH740_IES	EALS03_K4AH750_IES	
Type III	C3	Asymmetric Wide (AW)	7300	7500	50	B2-U0-G1	B2-U0-G1	EALS03_C3AW730_IES	EALS03_C3AW740_IES	EALS03_C3AW750_IES
	D3	Asymmetric Wide (AW)	9800	10100	70	B2-U0-G2	B2-U0-G2	EALS03_D3AW730_IES	EALS03_D3AW740_IES	EALS03_D3AW750_IES
	F3	Asymmetric Wide (AW)	14700	15100	116	B2-U0-G2	B2-U0-G2	EALS03_F3AW730_IES	EALS03_F3AW740_IES	EALS03_F3AW750_IES
	H3	Asymmetric Wide (AW)	19700	20200	140	B3-U0-G2	B3-U0-G3	EALS03_H3AW730_IES	EALS03_H3AW740_IES	EALS03_H3AW750_IES
	J3	Asymmetric Wide (AW)	24600	25200	186	B3-U0-G3	B3-U0-G3	EALS03_J3AW730_IES	EALS03_J3AW740_IES	EALS03_J3AW750_IES
K3	Asymmetric Wide (AW)	29600	30300	239	B3-U0-G3	B3-U0-G3	EALS03_K3AW730_IES	EALS03_K3AW740_IES	EALS03_K3AW750_IES	
Type II	C2	Asymmetric Narrow/Auto (AN)	7300	7500	50	B2-U0-G2	B2-U0-G2	EALS03_C2AN730_IES	EALS03_C2AN740_IES	EALS03_C2AN750_IES
	D2	Asymmetric Narrow/Auto (AN)	9800	10100	70	B2-U0-G2	B2-U0-G2	EALS03_D2AN730_IES	EALS03_D2AN740_IES	EALS03_D2AN750_IES
	F2	Asymmetric Narrow/Auto (AN)	14700	15100	116	B3-U0-G3	B3-U0-G3	EALS03_F2AN730_IES	EALS03_F2AN740_IES	EALS03_F2AN750_IES
	H2	Asymmetric Narrow/Auto (AN)	19700	20200	140	B3-U0-G3	B3-U0-G3	EALS03_H2AN730_IES	EALS03_H2AN740_IES	EALS03_H2AN750_IES
	J2	Asymmetric Narrow/Auto (AN)	24600	25200	186	B3-U0-G3	B3-U0-G3	EALS03_J2AN730_IES	EALS03_J2AN740_IES	EALS03_J2AN750_IES
K2	Asymmetric Narrow/Auto (AN)	29600	30300	239	B3-U0-G3	B3-U0-G3	EALS03_K2AN730_IES	EALS03_K2AN740_IES	EALS03_K2AN750_IES	

# Photometrics

## Evolve™ LED Area Light (EALS-03)

**EALS Type II - Asymmetric Narrow/Auto**  
30,300 Lumens, 5000K (EALS03\_K2AN750\_\_IES)

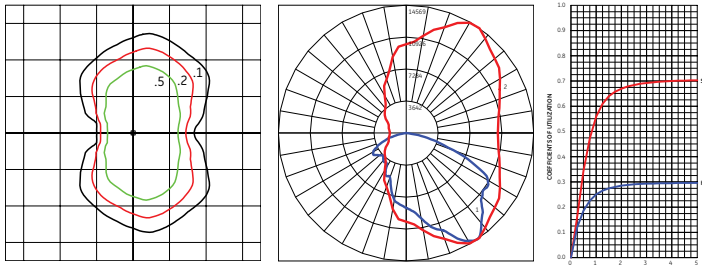

Grid Distance in Units of Mounting Height at 40' Initial Footcandle Values at Grade  
 — Vertical plane through horizontal angle of maximum candlepower at 55°  
 — Vertical plane through horizontal angle of 34°

**EALS Type VS - Symmetric High Angle**  
29,000 Lumens, 5000K (EALS03\_K5SH750\_\_IES)

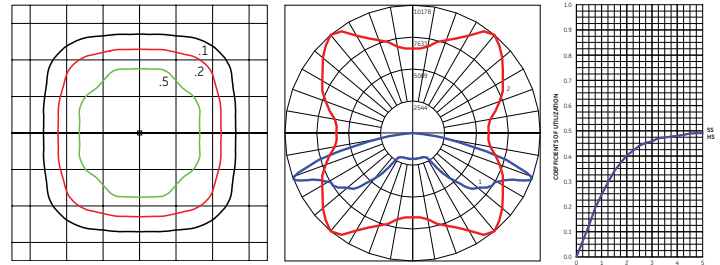

Grid Distance in Units of Mounting Height at 40' Initial Footcandle Values at Grade  
 — Vertical plane through horizontal angle of maximum candlepower at 50°  
 — Vertical plane through horizontal angle of 69°

**EALS Type III - Asymmetric Wide**  
30,300 Lumens, 5000K (EALS03\_K3AW750\_\_IES)

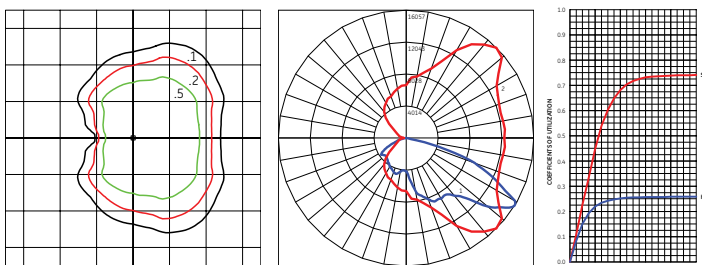

Grid Distance in Units of Mounting Height at 40' Initial Footcandle Values at Grade  
 — Vertical plane through horizontal angle of maximum candlepower at 45°  
 — Vertical plane through horizontal angle of 58°

**EALS Type VS - Symmetric Medium**  
30,000 Lumens, 5000K (EALS03\_K5SM750\_\_IES)

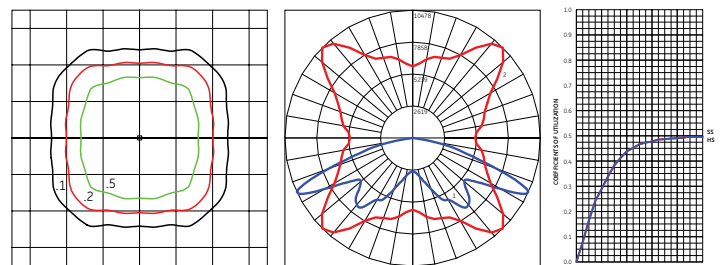

Grid Distance in Units of Mounting Height at 40' Initial Footcandle Values at Grade  
 — Vertical plane through horizontal angle of maximum candlepower at 45°  
 — Vertical plane through horizontal angle of 65°

**EALS Type IV - Asymmetric Forward**  
30,000 Lumens, 5000K (EALS03\_K4AF750\_\_IES)

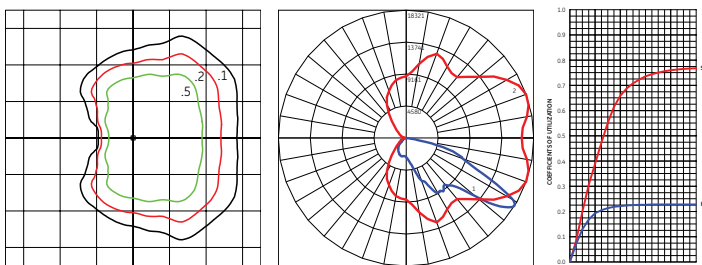

Grid Distance in Units of Mounting Height at 40' Initial Footcandle Values at Grade  
 — Vertical plane through horizontal angle of maximum candlepower at 20°  
 — Vertical plane through horizontal angle of 58°

**EALS Type VS - Symmetric Wide**  
30,300 Lumens, 5000K (EALS03\_K5SW750\_\_IES)

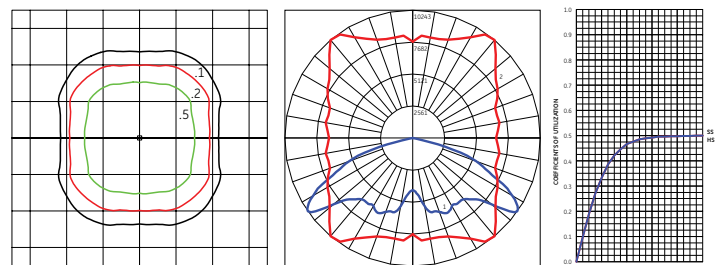

Grid Distance in Units of Mounting Height at 40' Initial Footcandle Values at Grade  
 — Vertical plane through horizontal angle of maximum candlepower at 50°  
 — Vertical plane through horizontal angle of 55°

**EALS Type IV - Asymmetric High Angle**  
29,000 Lumens, 5000K (EALS03\_K4AH750\_\_IES)

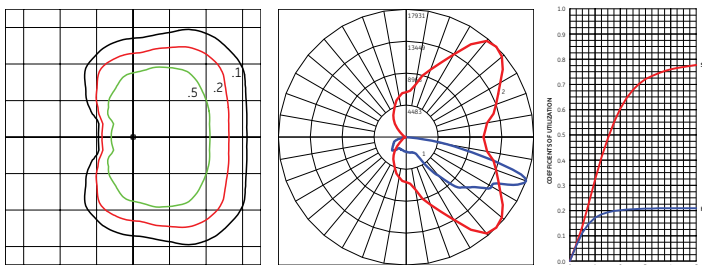

Grid Distance in Units of Mounting Height at 40' Initial Footcandle Values at Grade  
 — Vertical plane through horizontal angle of maximum candlepower at 45°  
 — Vertical plane through horizontal angle of 70°



# EAL Shielded Fixture Examples



Single Module Left/Right Shield



Double Module Left/Right Shield



Single Module Front Shield



Double Module Front Shield



Single Module Back Shield



Double Module Back Shield

<b>EALP01</b> 1 Module Optical Codes
C4, C3, C2
D4, D3, D2
F4, F3, F2

<b>EALS01</b> 1 Module Optical Codes
D4, D3, D2
F4, F3, F2

<b>EALP01</b> 2 Module Optical Codes
H4, H3, H2
J4, J3, J2
K4, J3, J2
L4, J3, J2
C5, D5, F5, H5, J5, K5, L5
M5, N5, Q5, S5, T5, U5, V5
KA, LA

<b>EALS01</b> 2 Module Optical Codes
H4, H3, H2
J4, J3, J2
K4, J3, J2
D5, F5, H5, J5, K5
N5, Q5, S5, T5, U5
KA

# Evolve™ LED Area Light

## Shielding for EAL Area Light Fixtures

The next evolution of the GE Evolve™ LED Area Light delivers even better trespass control. GE's exclusive reflective optical ring design produces superior vertical illuminance and efficiently directs the light without wasteful and unwelcomed light spill into neighboring properties. Due to the extensive variation of parking lot configurations coupled with tightening ordinances, GE now offers a full array of shielding to accommodate challenging sites.

The shielding options available for the GE Evolve Area Light focus on the following applications:

- Left and Right cutoff
- Front cutoff
- Backlight control and B-U-G improvement

Within each of the shielding families, there are multiple shielding cutoff levels that are categorized in mounting height (MH) increments. GE accommodates cutoff distance from 1MH to 2.5 MH in 0.5 MH increments. The shields that are listed are for the most common applications. Please contact the manufacturer if your need is not listed.

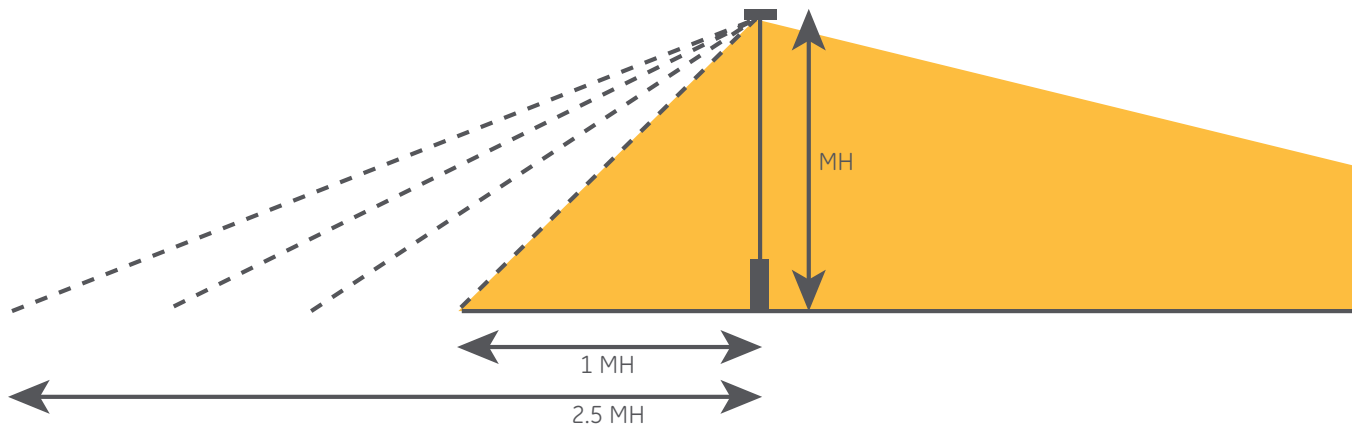

All shields can be installed easily in the field. The next evolution of the GE Evolve LED Area Light and shielding options will help you meet any parking lot challenge.

# GE Evolve™

## LED Flood & Spot Lighting

### EFM1



Project name \_\_\_\_\_  
 Date \_\_\_\_\_  
 Type \_\_\_\_\_

## Ordering Number Logic

**E FM1 01**

PROD. ID	GEN.	VOLTAGE	OPTIC CODE	DISTRIBUTION*	CRI	CCT	DIMMING	CONTROLS	MOUNTING	FINISH	OPTIONS
E = Evolve FM = Flood Medium 1 = Standard	01 = 1st Gen	0 = 120-277V* 1 = 120V 2 = 208V 3 = 240V 4 = 277V 5 = 480V D = 347V H = 347-480V* *Not available with fusing	AA = 5,000lm BB = 10,000lm CC = 15,000lm DD = 20,000lm EE = 24,000lm FF = 27,000lm	65 = NEMA 6x5 66 = NEMA 6x6 76 = NEMA 7x6 77 = NEMA 7x7 (80° Wide Flood) T3 = Type 3/ Facade/Billboard* S2 = 20° Spot* *Not available with optical code DD, EE or FF	7 = 70 (min)	30 = 3000K 40 = 4000K 50 = 5000K	A = ANSI C1 36.41 7-Pin Receptacle** D = No Receptacle, with external dimming 18/2 3ft cable* N = No PE receptacle & non-dimmable* P = ANSI 7-pin receptacle with external dimming 18/2 3ft cable** +Unrestricted aiming angle ++All units with option A and P have Restricted Aiming Angle. See page 8.	A = No Control D = Shorting Cap* See below ordering logic for dimming PE and standard PE control options. Light Grid also available. Must order separately. *Can only be ordered with dimming option A or P	K1 = Knuckle Slipfitter for 1.9 in.-2.3 in. OD Tenon* S1 = Knuckle Slipfitter for 1.9 in.-3.0 in. OD Tenon* K2 = Knuckle Slipfitter for 1.9 in.-2.3 in. OD Tenon with external 3ft #14/3 power cable S2 = Knuckle Slipfitter for 1.9 in.-3.0 in. OD Tenon with external 3ft #14/3 power cable V1 = Knuckle Wall Mount* T1 = Trunnion with external 3ft #14/3 power cable. *Supplied with leads	GRAY = Gray BLCK = Black DKBZ = Dark Bronze WHITE = White	F = Fusing< H = Daintree enabled motion sensor# ^ L = Tool-Less Entry P = Prewired with 6 FT #14/3 cable* R = 10kV/5kA Enhanced Surge Protection T = 20kV/10kA Surge Protection> U = DALI Dimming +# V = 3-Position Terminal Block XXX = Special Options * When Dimming option is selected without Dimming PE, a #14-5 cable will be supplied at length above + Compatible with LightGrid 2.0 nodes. # Not available in 347V-480V, optic code EE and FF ^ Only available in mount K1 or S1 < Dimming and Fusing not available with Optical Code AA for distributions "T3" and "S2" > Check manufacturer for availability <b>NOTE:</b> Options F, R, T, and V not available with optical code AA with voltage 347 - 480 and distributions 65, 66, 76, and 77.

OPTICAL CODE	DIST. CODE	OPTICAL DIST./NEMA CLASS	TYPICAL INITIAL LUMENS		TYPICAL SYSTEM WATTAGE		3000K		IES FILE NUMBER	
			3000K	5000K	120-277V	347-480V	120-277V	5000K		
AA	77	7X7	4900	5000	30	32	EFM101_AA77730_120-277V_IES	EFM101_AA77730_347-480V_IES	EFM101_AA77740_120-277V_IES	EFM101_AA77740_347-480V_IES
BB	77	7X7	9800	10000	64	64	EFM101_BB77730_IES		EFM101_BB77740_IES	EFM101_BB77750_IES
CC	77	7X7	14700	15000	96	96	EFM101_CC77730_IES		EFM101_CC77740_IES	EFM101_CC77750_IES
DD	77	7X7	20400	20900	146	146	EFM101_DD77730_IES		EFM101_DD77740_IES	EFM101_DD77750_IES
EE	77	7X7	23400	24000	175	175	EFM101_EE77730_IES		EFM101_EE77740_IES	EFM101_EE77750_IES
FF	77	7X7	26200	27000	196	196	EFM101_FF77730_IES		EFM101_FF77740_IES	EFM101_FF77750_IES
AA	76	7X6	4700	4800	30	32	EFM101_AA76730_120-277V_IES	EFM101_AA76730_347-480V_IES	EFM101_AA76740_120-277V_IES	EFM101_AA76740_347-480V_IES
BB	76	7X6	9500	9700	64	64	EFM101_BB76730_IES		EFM101_BB76740_IES	EFM101_BB76750_IES
CC	76	7X6	14300	14600	96	96	EFM101_CC76730_IES		EFM101_CC76740_IES	EFM101_CC76750_IES
DD	76	7X6	19900	20400	146	146	EFM101_DD76730_IES		EFM101_DD76740_IES	EFM101_DD76750_IES
EE	76	7X6	23300	23900	175	175	EFM101_EE76730_IES		EFM101_EE76740_IES	EFM101_EE76750_IES
FF	76	7X6	25600	26300	196	196	EFM101_FF76730_IES		EFM101_FF76740_IES	EFM101_FF76750_IES
AA	66	6X6	4700	4800	30	32	EFM101_AA66730_120-277V_IES	EFM101_AA66730_347-480V_IES	EFM101_AA66740_120-277V_IES	EFM101_AA66740_347-480V_IES
BB	66	6X6	9400	9600	64	64	EFM101_BB66730_IES		EFM101_BB66740_IES	EFM101_BB66750_IES
CC	66	6X6	14200	14500	96	96	EFM101_CC66730_IES		EFM101_CC66740_IES	EFM101_CC66750_IES
DD	66	6X6	19700	20200	146	146	EFM101_DD66730_IES		EFM101_DD66740_IES	EFM101_DD66750_IES
EE	66	6X6	22900	23500	175	175	EFM101_EE66730_IES		EFM101_EE66740_IES	EFM101_EE66750_IES
FF	66	6X6	25200	25900	196	196	EFM101_FF66730_IES		EFM101_FF66740_IES	EFM101_FF66750_IES
AA	65	6X5	4400	4500	30	32	EFM101_AA65730_120-277V_IES	EFM101_AA65730_347-480V_IES	EFM101_AA65740_120-277V_IES	EFM101_AA65740_347-480V_IES
BB	65	6X5	8900	9100	64	64	EFM101_BB65730_IES		EFM101_BB65740_IES	EFM101_BB65750_IES
CC	65	6X5	13400	13700	96	96	EFM101_CC65730_IES		EFM101_CC65740_IES	EFM101_CC65750_IES
DD	65	6X5	18700	19100	146	146	EFM101_DD65730_IES		EFM101_DD65740_IES	EFM101_DD65750_IES
EE	65	6X5	21600	22200	175	175	EFM101_EE65730_IES		EFM101_EE65740_IES	EFM101_EE65750_IES
FF	65	6X5	23800	24400	196	196	EFM101_FF65730_IES		EFM101_FF65740_IES	EFM101_FF65750_IES
AA*	T3	Type 3	6400	6600	50	50	EFM101_AAT3730_IES		EFM101_AAT3740_IES	EFM101_AAT3750_IES
BB	T3	Type 3	10200	10500	88	88	EFM101_BBT3730_IES		EFM101_BBT3740_IES	EFM101_BBT3750_IES
CC	T3	Type 3	14700	15000	141	141	EFM101_CCT3730_IES		EFM101_CCT3740_IES	EFM101_CCT3750_IES
AA*	S2	20° Spot	7100	7300	50	50	EFM101_AAS2730_IES		EFM101_AAS2740_IES	EFM101_AAS2750_IES
BB	S2	20° Spot	11300	11600	88	88	EFM101_BBS2730_IES		EFM101_BBS2740_IES	EFM101_BBS2750_IES
CC	S2	20° Spot	16300	16700	141	141	EFM101_CCS2730_IES		EFM101_CCS2740_IES	EFM101_CCS2750_IES

\*Dimming not available

# GE Evolve™

## LED Flood & Spot Lighting

### EFM1

## Photometrics:

### Evolve™ LED Flood Light (EFM1)

**EFM1**  
NEMA 6x5

19,100 Lumens  
4000K  
EFM101\_DD65740\_-

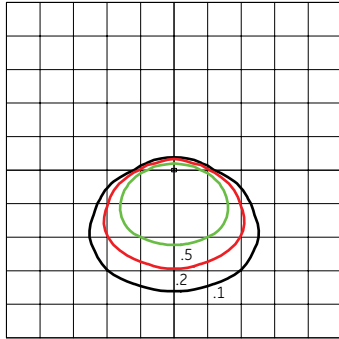

Grid Distance in Units of Mounting Height at 35°  
Tilt is 45°. Initial Footcandle Values at Grade

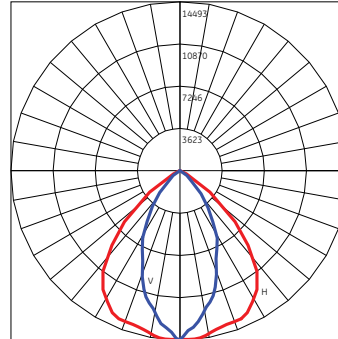

— Vertical angle of Max Cd. at -2.5°  
— Horizontal angle of Max Cd. at 2.5°

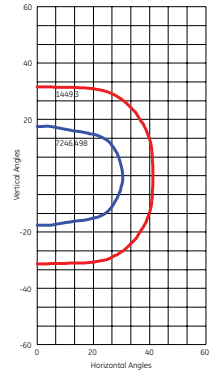

**EFM1**  
NEMA 6x6

20,200 Lumens  
4000K  
EFM101\_DD66740\_-

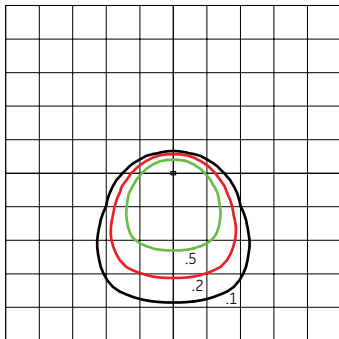

Grid Distance in Units of Mounting Height at 35°  
Tilt is 45°. Initial Footcandle Values at Grade

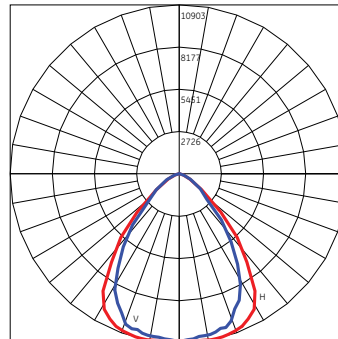

— Vertical angle of Max Cd. at -5°  
— Horizontal angle of Max Cd. at 2.5°

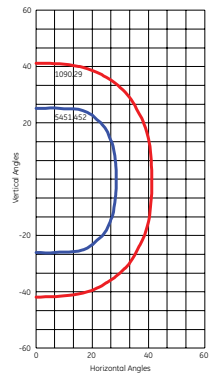

**EFM1**  
NEMA 7x6

20,400 Lumens  
4000K  
EFM101\_DD76740\_-

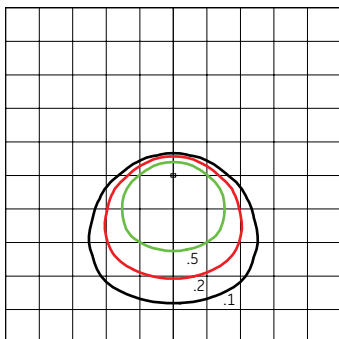

Grid Distance in Units of Mounting Height at 35°  
Tilt is 45°. Initial Footcandle Values at Grade

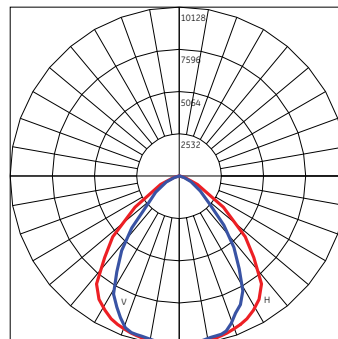

— Vertical angle of Max Cd. at -2.5°  
— Horizontal angle of Max Cd. at 2.5°

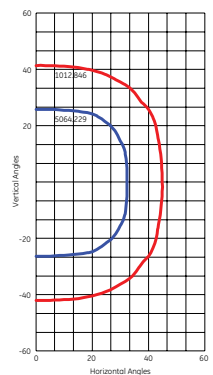

# GE Evolve™

## LED Flood & Spot Lighting

### EFM1

## Photometrics:

### Evolve™ LED Flood Light (EFM1)

**EFM1**  
NEMA 7x7

20,900 Lumens  
4000K  
EFM101\_DD77740\_-

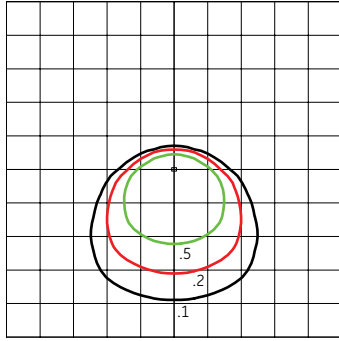

Grid Distance in Units of Mounting Height at 35'  
Tilt is 45°. Initial Footcandle Values at Grade

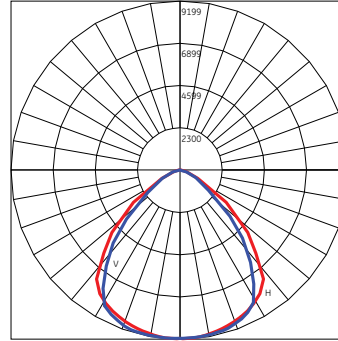

— Vertical angle of Max Cd. at -7.5°  
— Horizontal angle of Max Cd. at 5°

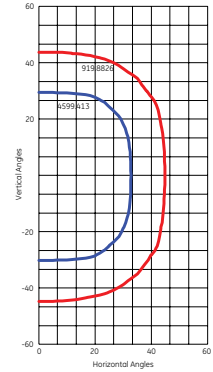

**EFM1**  
TYPE III  
FACADE/BILLBOARD

15,000 Lumens  
4000K  
EFM101\_CCT3740\_-

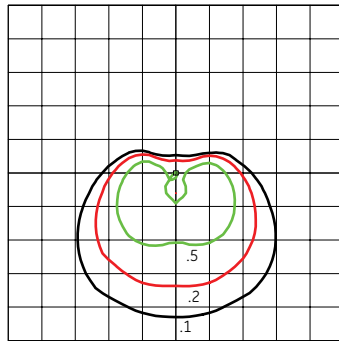

Grid Distance in Units of Mounting Height at 35'  
Tilt is 25°. Initial Footcandle Values at Grade

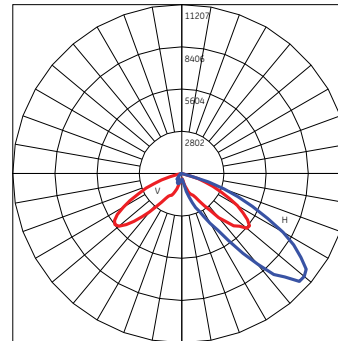

— Vertical angle of Max Cd. at 47.5°  
— Horizontal angle of Max Cd. at 15°

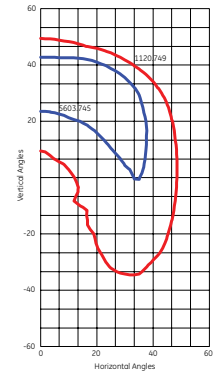

**EFM1**  
20° SPOT

16,700 Lumens  
4000K  
EFM101\_CCS2740\_-

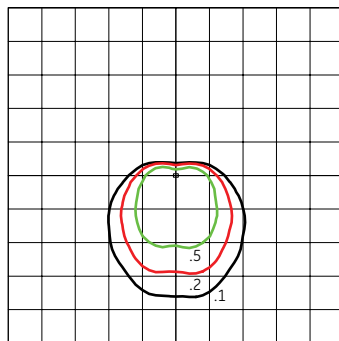

Grid Distance in Units of Mounting Height at 35'  
Tilt is 45°. Initial Footcandle Values at Grade

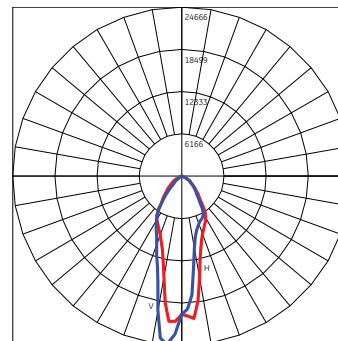

— Vertical angle of Max Cd. at -5°  
— Horizontal angle of Max Cd. at 0°

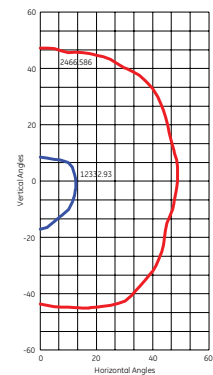

## **5 HORIZONTAL PLANE RESULTS**

1. Grade with photocell lights only (see drawing LGHT Study Sheet 1):
  - a. Substation meets all PGE requirements of 0.5 foot-candles at the property line
  - b. Substation meets the City of Wilsonville light zone overlay requirements of 0.5 foot-candles at the property line.

## **6 VERTICAL PLANE RESULTS**

1. Grade with photocell lights only (see drawing Normal operation – photocell lights):
  - a. Substation meets the City of Wilsonville light zone overlay requirements of 0.4 foot-candles at the property line.



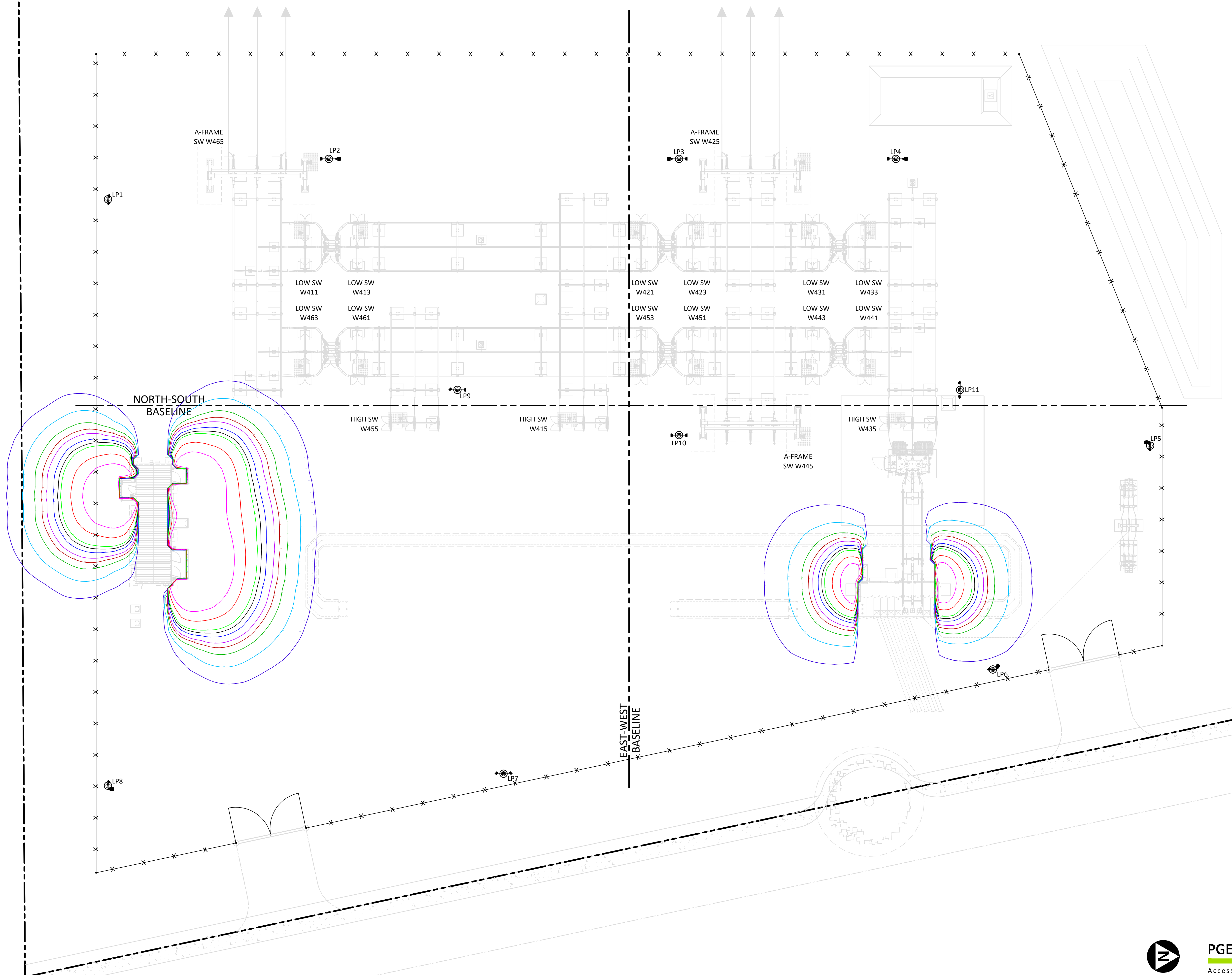

**LEGEND**

	LIGHT POLE
	FENCE
	PROPERTY LINE
	STATION BASELINE
	0.1 FOOT-CANDLES
	0.25 FOOT-CANDLES
	0.5 FOOT-CANDLES
	0.75 FOOT-CANDLES
	1.0 FOOT-CANDLES
	1.5 FOOT-CANDLES
	2.0 FOOT-CANDLES
	3.0 FOOT-CANDLES
	5.0 FOOT-CANDLES
	10.0 FOOT-CANDLES

**NOTES:**

1. SUBSTATION MEETS THE REQUIREMENT OF 0.5 FOOT-CANDLES AT THE PROPERTY LINE AT ALL LOCATIONS.

REV.	DATE	DESCRIPTION	APPD.	CHK.	APPD.
0	05-23-23	ORIGINAL ISSUE: AWO 1000009925.			
PEI	JCO	AFL	AG	PNK	

**Portland General Electric**

**MEMORIAL SUBSTATION**  
 LIGHTING STUDY  
 AREA LIGHTING - PHOTO CELL  
 (0'-0" ABOVE GRADE)

REV.	SHEET	DISTR. CASE	SCALE
0	1 OF 6	AG	1" = 20'-0"

**PGE Internal Use**  
 Access Limited to PGE

**FOR PERMIT ONLY**  
**NOT FOR CONSTRUCTION**

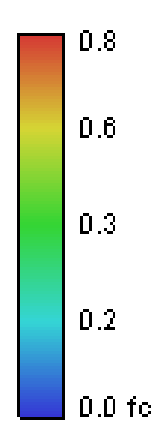
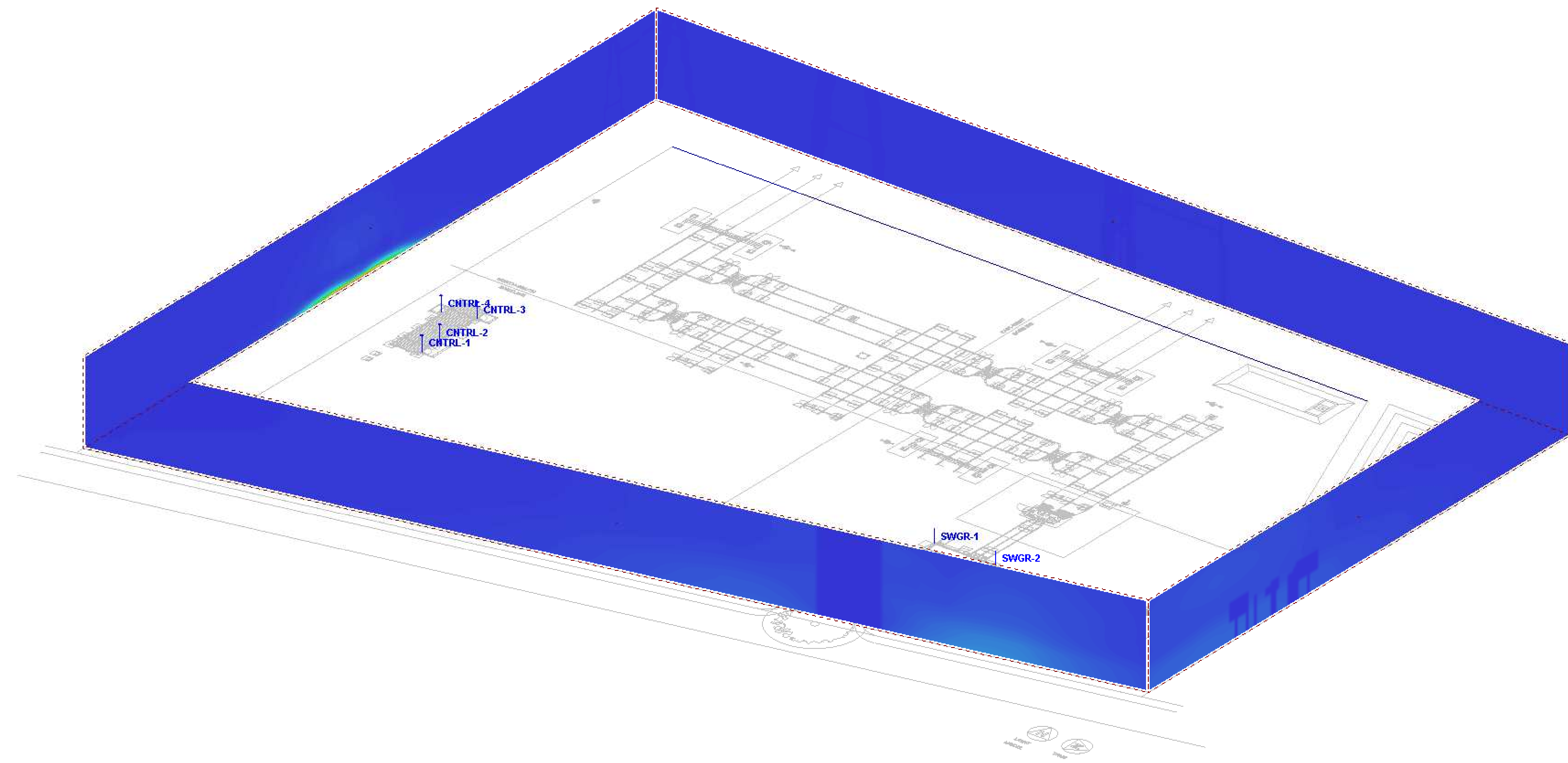

NORMAL OPERATION - PHOTOCCELL LIGHTS ONLY





# memo portland

---

to **Amy Pepper, City of Wilsonville**

from **Carrie Brennecke, MIG and Andrew Yaden, PGE**

re **Request to Waive Access Spacing Requirement in City of Wilsonville Public Works Construction Standards**

date **12/04/23**

---

MIG is preparing Conditional Use and Site Design land use applications for a new PGE substation located at 27601 SW Parkway Avenue in Wilsonville, Oregon. One requirement for the application is a Trip Generation Memorandum which has been prepared by DKS for the City of Wilsonville. The purpose of the Trip Generation Memorandum is to determine how much additional traffic the proposed land use would generate through the City's transportation system, if any, and provide a review of the site plan and its consistency with City transportation standards (access spacing, street frontage improvements, etc.).

The project proposes two new driveways (accesses) on SW Parkway Avenue. The Memorandum concluded that the two driveways are not in compliance with the City of Wilsonville Public Works Construction Standards.

"Access spacing requirements for the City of Wilsonville are provided in the City's Public Works Construction Standards<sup>2</sup> and are based on the street classification. SW Parkway Avenue is classified as a minor arterial and therefore has a minimum access spacing of 600 feet and a desired spacing of 1,000 feet. Accesses include driveways, alleys, and streets. The total distance between the two proposed driveways is 310 feet, which does not meet the minimum access spacing standard. Because the site frontage is 525 feet in length and there are existing driveways on adjacent parcels that are located close to the edge of the project site, 600 feet access spacing cannot be achieved.

Because the project site generates such a low volume of vehicle trips (see Vehicle Trip Generation), the currently proposed accesses locations and spacings are not a safety concern as currently proposed on the site plan."

Due to the fact that compliance the Public Works Construction Standard is not directly addressed in applicants' narrative responses to the Planning and Land Development Ordinance (Development Code) requirements, the City of Wilsonville Engineering requested the applicant to prepare a memorandum with additional information about why a second driveway is necessary to serve the

site given the low number of trips. Below is the justification from PGE on why two driveways are requested for the site:

- The PGE substation requires two access points because there is not adequate space on the lot for the substation equipment and appropriately sized PGE vehicles to access and service the equipment and to have space for a vehicle turnaround. The waiver is requested due to issue that the size and lot configuration does not allow for the substation equipment and a vehicle turn around on site. Therefore, two access points to allow for one way in and one way out access is needed.
- The PGE substation requires two access points to service the three (3) transmission towers outside of the substation fence adjacent to the ODOT ROW. A one-way drive around the perimeter of the property is included in the site design to allow for the service of the towers on the west property line. The requirement for two stormwater detention facilities do not allow adequate space for a truck turnaround in a location that would allow access to the three towers from one access point.
- The number of trips generated for the use is not creating the need for the two access points. No average daily trip generation is expected, some trip generation is expected on a monthly basis as only two separate trips to the site for maintenance are expected every 45 – 60 days.
- Due to the nature of servicing and maintaining electrical equipment and towers, two access points are needed by PGE to ensure the safety of their employees in case of emergency.
- The need for a waiver is due to existing conditions on adjacent properties. Because the site frontage is 525 feet in length it precludes two driveways. The size of the site and the limited frontage only allows for one driveway as there are existing driveways on adjacent parcels that are located close to the edge of the project site that 600 feet access spacing cannot be achieved. The site is in between two developed sites, which precludes working with adjacent property owners achieve the required access spacing. Note both adjacent uses not industrial uses but are commercial and institutional.

Please see attached Mobile Path Exhibit 1 & 2 for demonstration of the the need for the second access to the site for the PGE vehicles and employees to safely access the equipment for maintenance and emergencies.

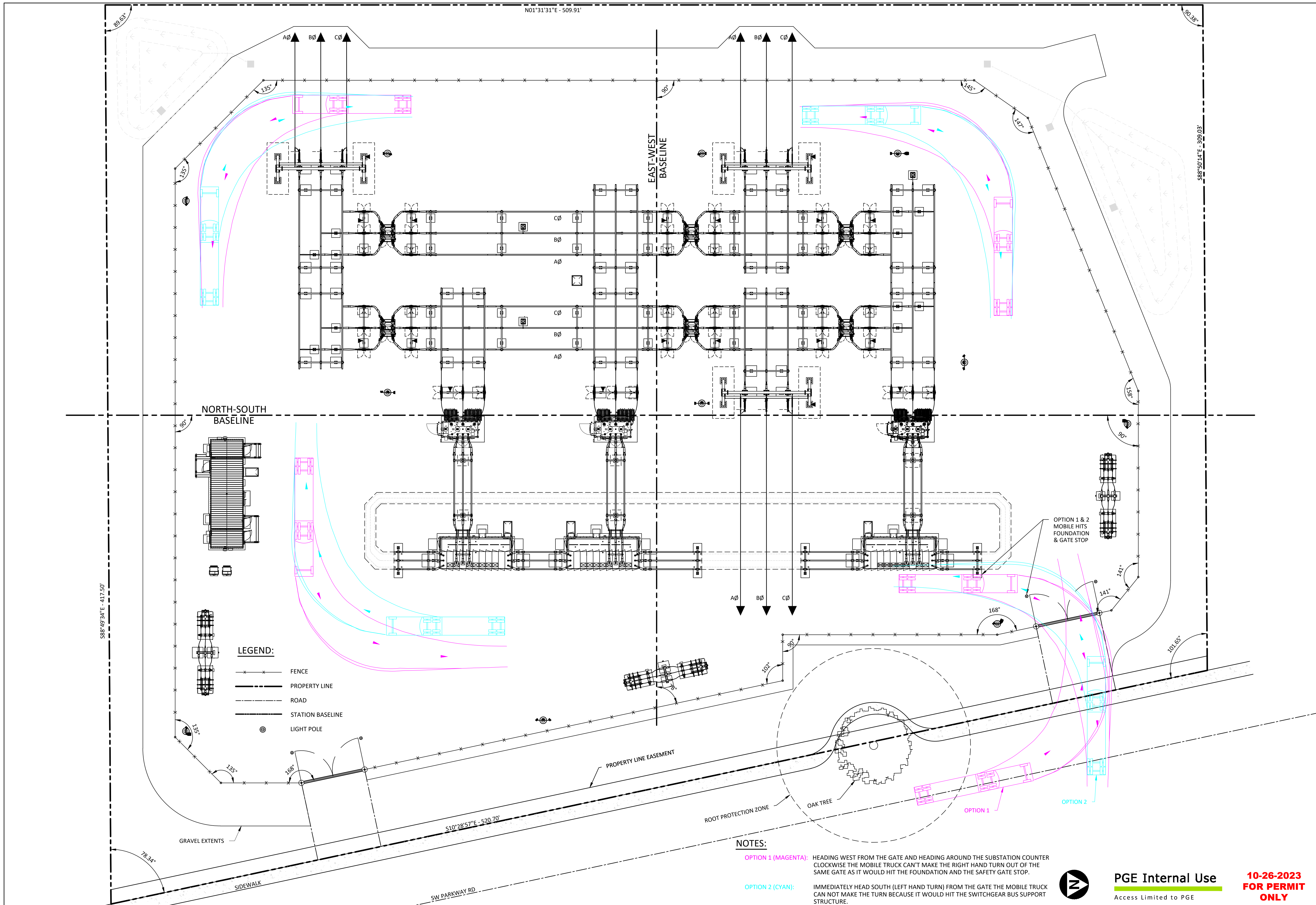

S88°49'34"E - 417.50'

N01°31'31"E - 509.91'

S88°50'14"E - 309.03'

NORTH-SOUTH  
BASELINE

EAST-WEST  
BASELINE

LEGEND:

- x — FENCE
- — — PROPERTY LINE
- — — ROAD
- — — STATION BASELINE
- ⊙ LIGHT POLE

NOTES:

**OPTION 1 (MAGENTA):** HEADING WEST FROM THE GATE AND HEADING AROUND THE SUBSTATION COUNTER CLOCKWISE THE MOBILE TRUCK CAN'T MAKE THE RIGHT HAND TURN OUT OF THE SAME GATE AS IT WOULD HIT THE FOUNDATION AND THE SAFETY GATE STOP.

**OPTION 2 (CYAN):** IMMEDIATELY HEAD SOUTH (LEFT HAND TURN) FROM THE GATE THE MOBILE TRUCK CAN NOT MAKE THE TURN BECAUSE IT WOULD HIT THE SWITCHGEAR BUS SUPPORT STRUCTURE.

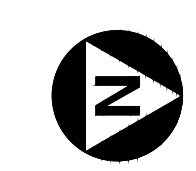

**PGE Internal Use**  
Access Limited to PGE

**10-26-2023**  
**FOR PERMIT ONLY**

**MMRL-1002**

SHEET 1 OF 2

REV. 0

DISTR. CODE AG

SCALE 1" = 20'-0"

**Portland General Electric**

**PGE**

**MEMORIAL SUBSTATION**  
FUTURE GENERAL LAYOUT  
WITH MOBILE PATHS  
NORTH GATE ENTRANCE

REV.	DATE	DESCRIPTION	ENGR.	CHK.	APPD.
0	XX-XX-23	ORIGINAL ISSUE: AWO 1000009925.	PEI	JJO	AFL
					KSC
					PNK



N01°31'31"E - 509.91'

90°35'

S88°50'14"E - 309.03'

S88°49'34"E - 417.50'

78.34°

NORTH-SOUTH  
BASELINE

EAST-WEST  
BASELINE

ENRNL ENCL

PROPERTY LINE EASEMENT

ROOT PROTECTION ZONE

OAK TREE

SIDEWALK

SW PARKWAY RD

S10°28'57"E - 520.70'

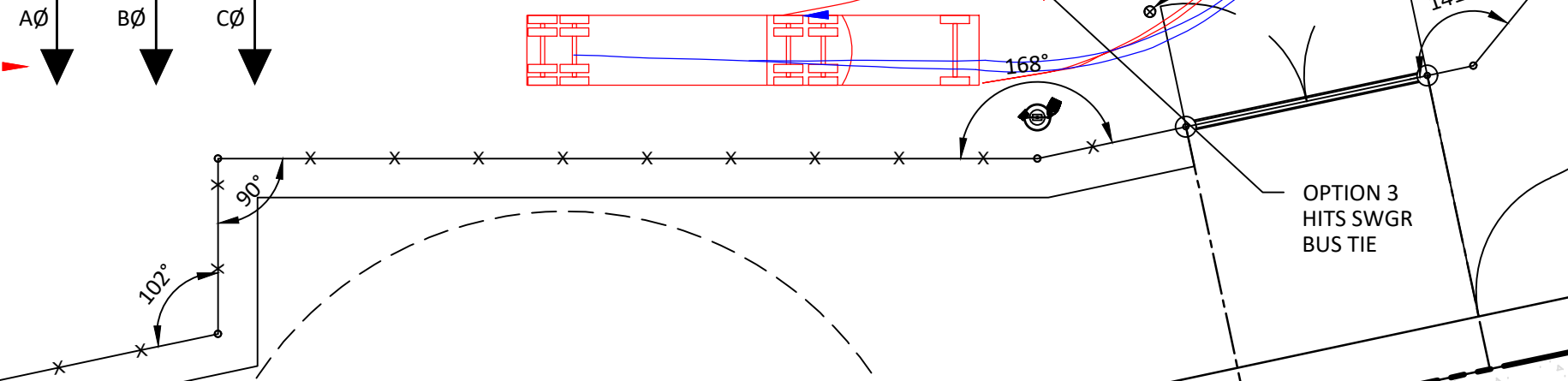
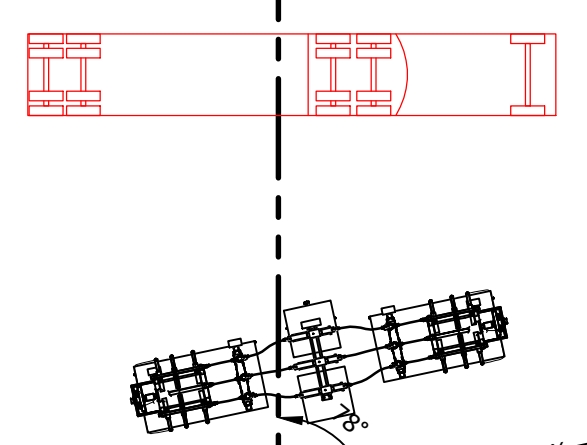
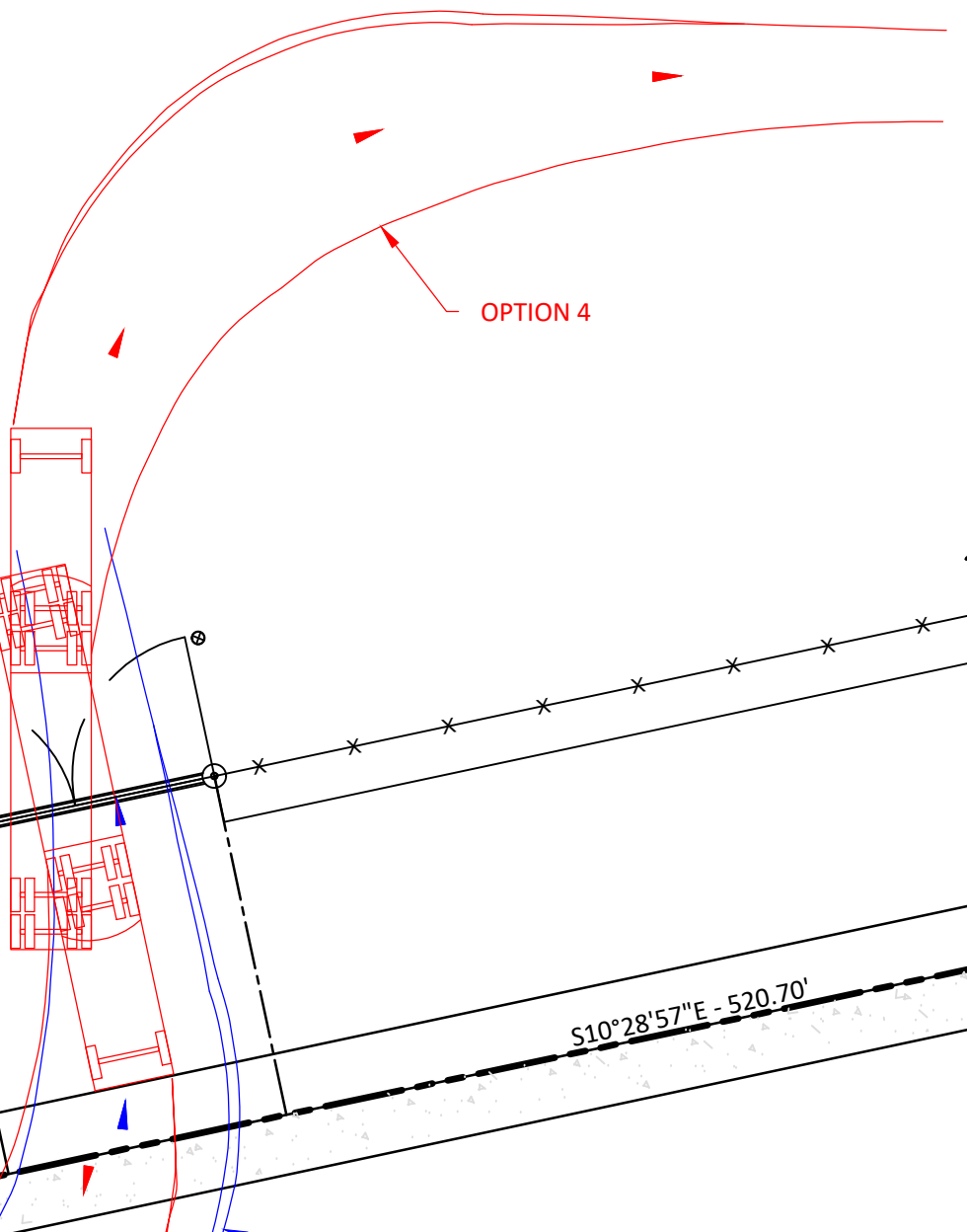
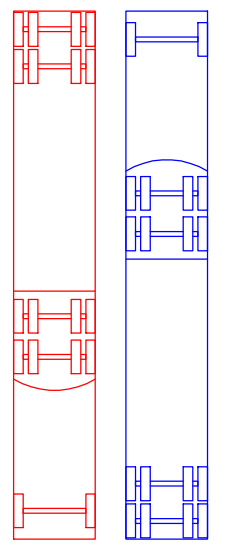
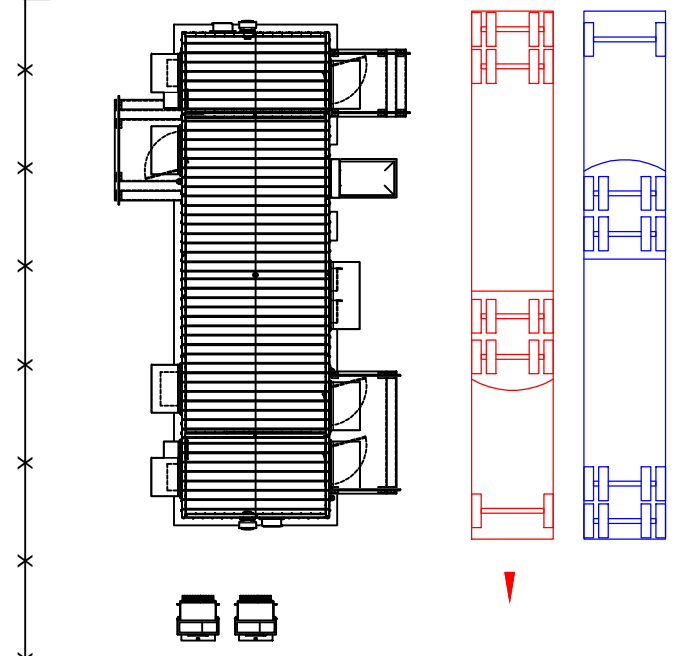
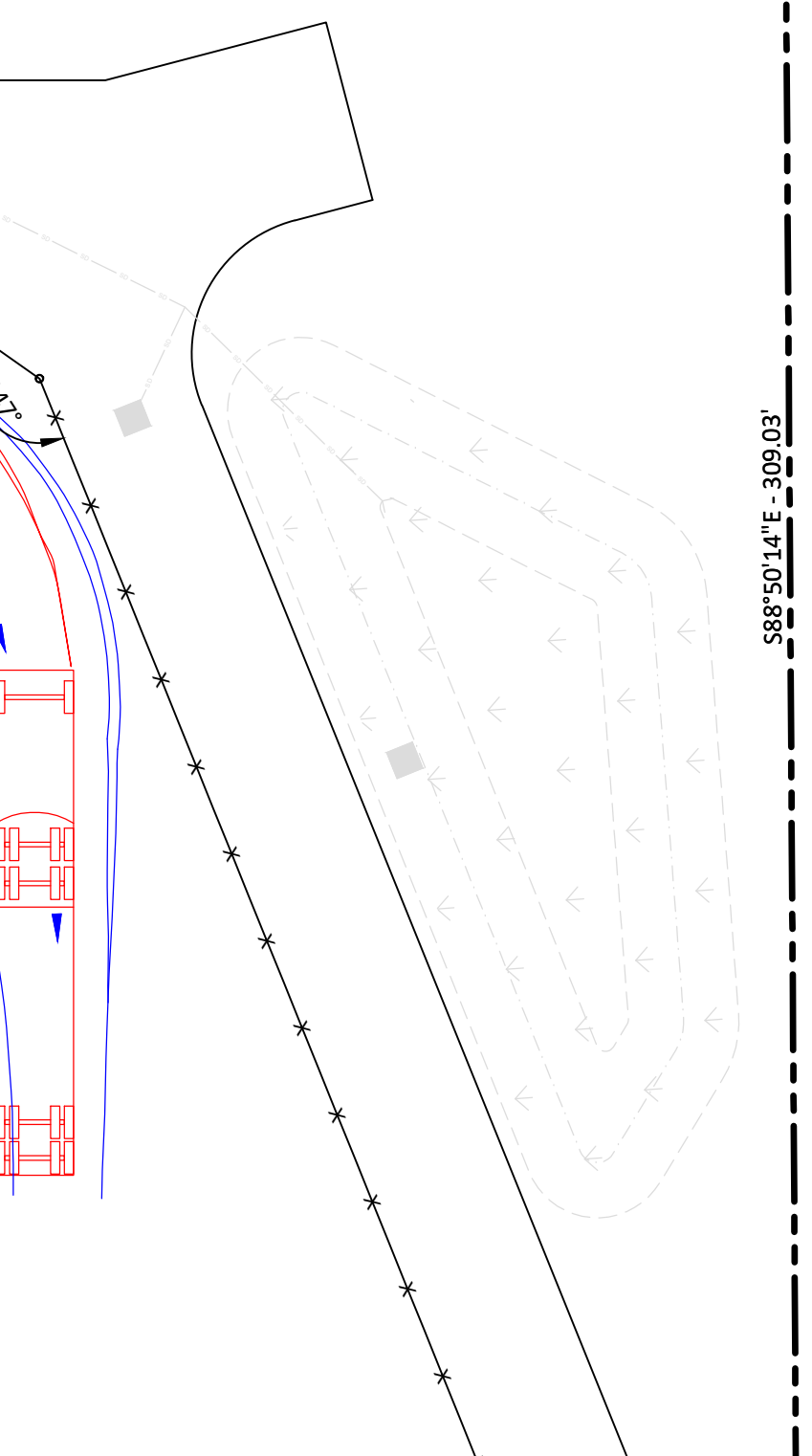
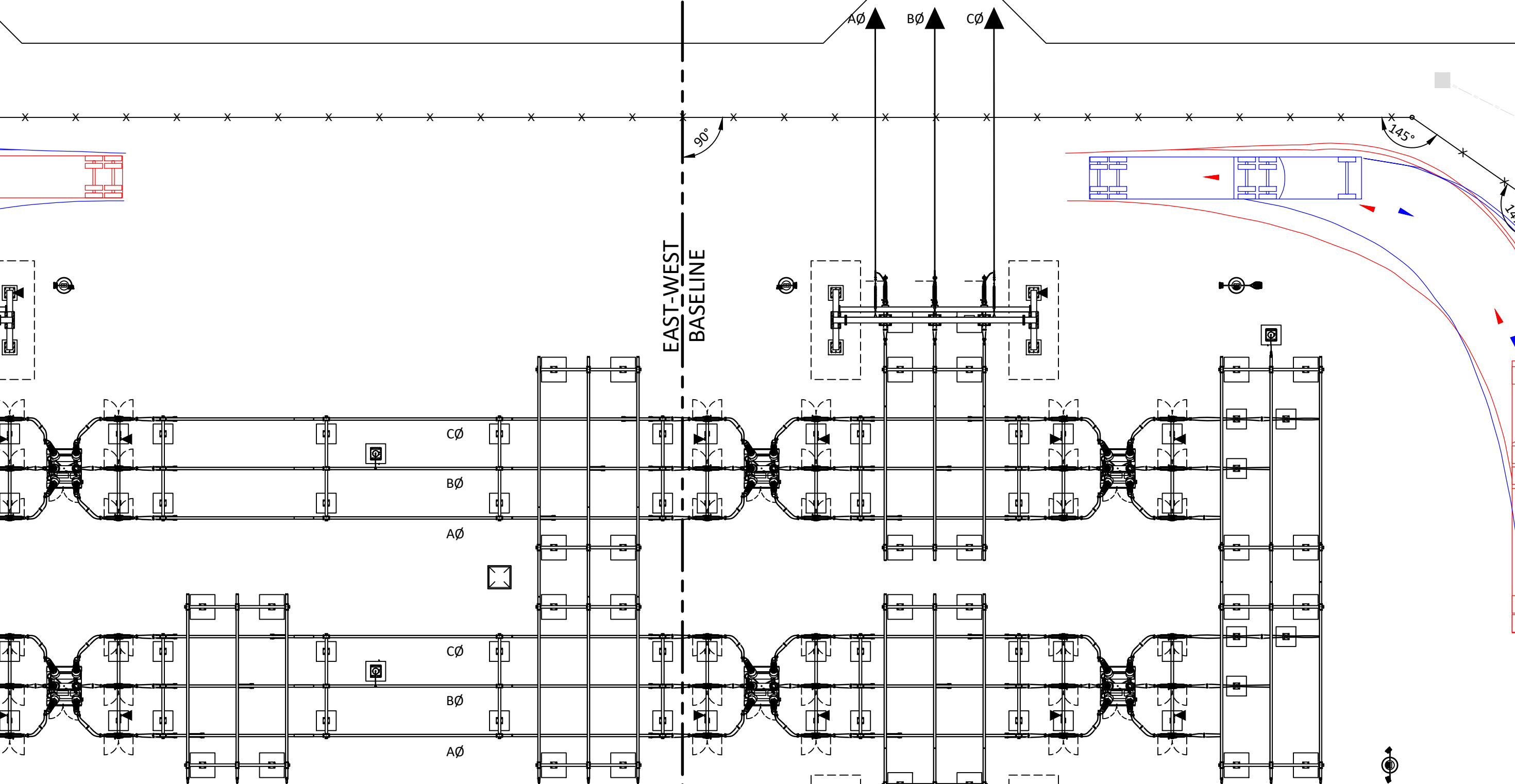
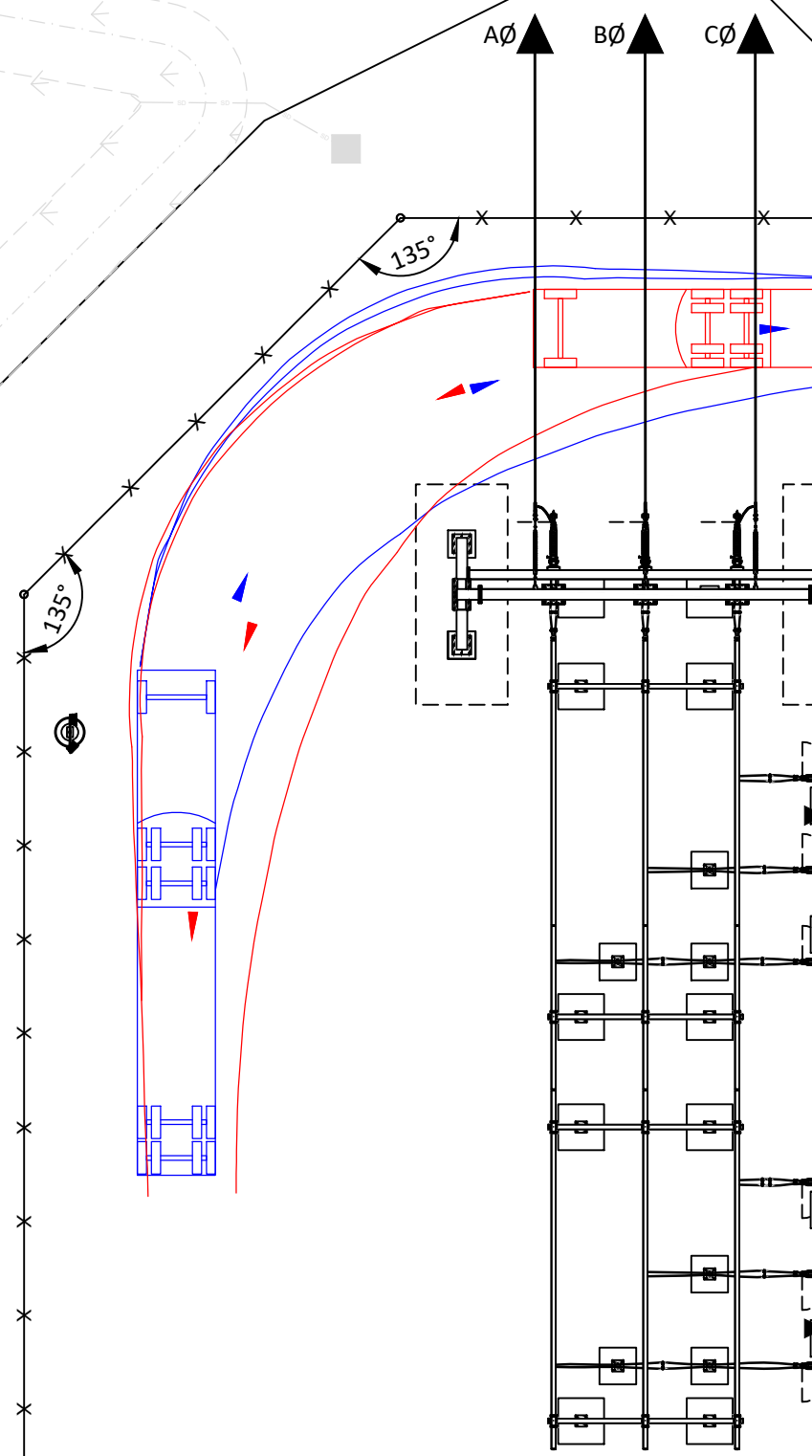

OPTION 3 & 4  
MOBILE HITS  
GATE STOP

OPTION 3  
HITS SWGR  
BUS TIE

LEGEND:

- FENCE
- PROPERTY LINE
- ROAD
- STATION BASELINE
- ⊙ LIGHT POLE

NOTES:

OPTION 3 (BLUE):

HEADING WEST FROM THE GATE AND HEADING AROUND THE SUBSTATION CLOCKWISE THE MOBILE TRUCK CAN'T HEAD SOUTH (RIGHT HAND TURN) AND EXIT OUT OF THE SAME GATE AS IT WOULD HIT THE FOUNDATION AND THE SAFETY GATE STOP.

OPTION 4 (RED):

IMMEDIATELY HEAD NORTH (RIGHT HAND TURN) FROM THE GATE THE MOBILE TRUCK CAN NOT MAKE THE TURN BECAUSE IT WOULD HIT THE SAFETY GATE STOP.



PGE Internal Use  
Access Limited to PGE

10-26-2023  
FOR PERMIT  
ONLY

REV.	DATE	REVISION DESCRIPTION
0	XX-XX-23	ORIGINAL ISSUE: AWO 1000009925.

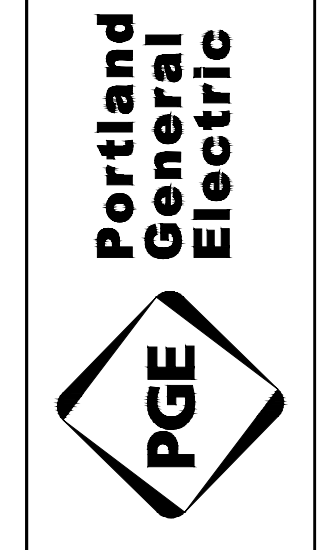

MEMORIAL SUBSTATION  
FUTURE GENERAL LAYOUT  
WITH MOBILE PATHS  
SOUTH GATE ENTRANCE

MMRL-1002	SHEET 2 OF 2	DISTR. CODE AG
REV. 0	SCALE 1" = 20'-0"	

DRAWN	CHK.	APPD.
PEI	JJO	KSC
ENGR.	AFL	PNK



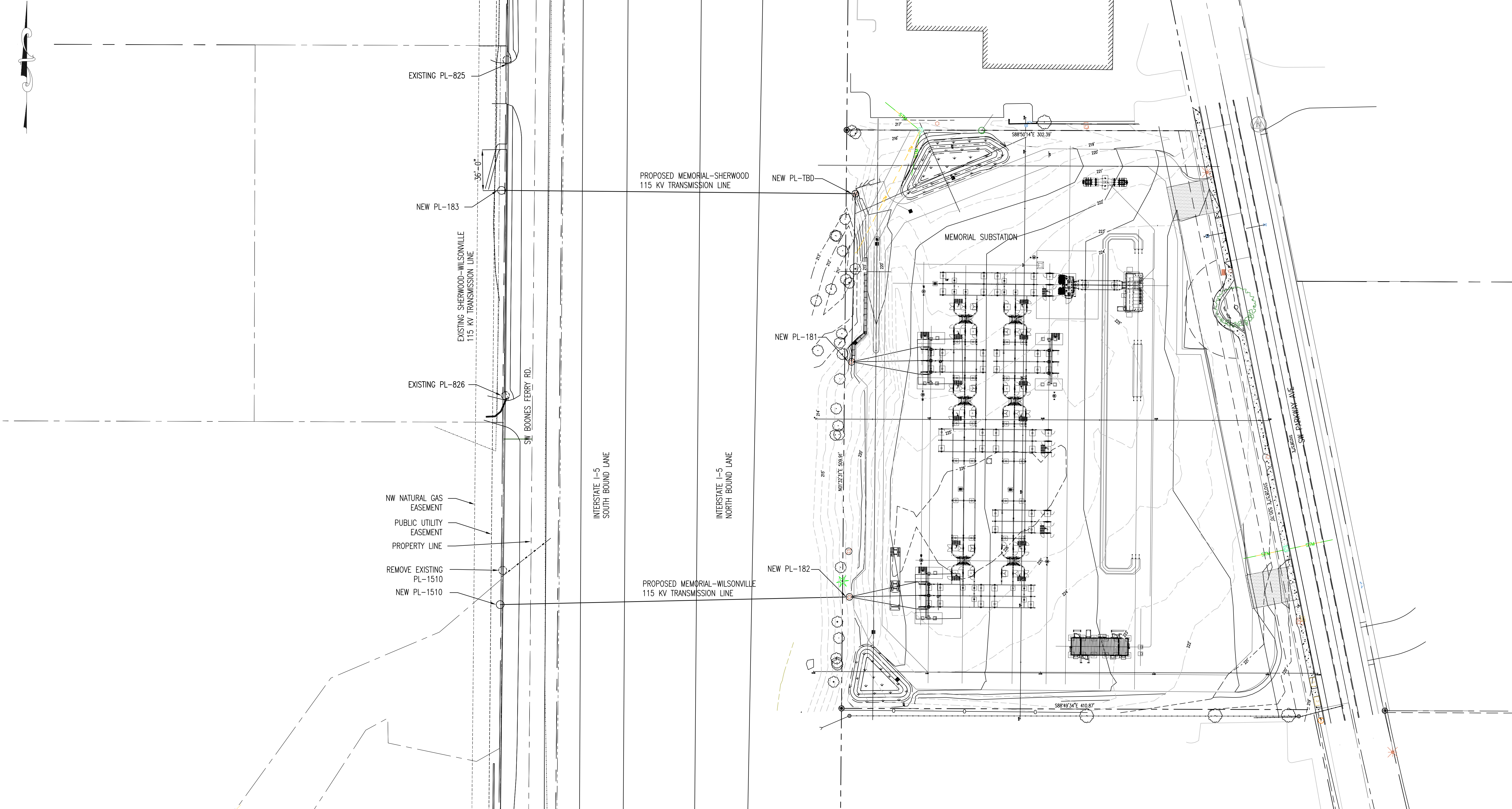

LEGEND:

- PROPERTY LINE
- PUBLIC UTILITY EASEMENT & NW NATURAL EASEMENT
- GAS LINE
- 115 KV TRANSMISSION LINE
- PGE EXISTING STRUCTURE
- PGE NEW STRUCTURE

1	ISSUE FOR INFORMATION -UPDATED LINWORK	11/13/2023	ALB	ALB	MG	MG
0	ISSUE FOR INFORMATION	07/20/2023	ALB	ALB	MG	MG
REV	DESCRIPTION	DATE	DRN	DSGN	CKD	APPD
DATE:	SCALE:	DRAWING NO.	JOB NO.		JOB NO.	
07/20/2023	1" = 40'	MEMORIAL SUBSTATION	M3280849		M3280849	
TITLE MEMORIAL SUBSTATION LOOP EXHIBIT- T-LINE						
CIRCUIT MEMORIAL-SHERWOOD & MEMORIAL WILSONVILLE						
LOCATION MEMORIAL SUBSTATION, WILSONVILLE OR						
COUNTY WASHINGTON						
SECTION(S) C3111D						
ENGINEER SUPERVISOR MATT GORDANIER						
TRANSMISSION ENGINEERING & SPECIALIZED DESIGN 3700 SE 17TH AVE. PORTLAND, OR 97202						
ENGINEER ANDY BREWER			PHONE 503-915-9441		DRAWN BY ANDY BREWER	
© PORTLAND GENERAL ELECTRIC CO. - ALL RIGHTS RESERVED						SHEET 1 OF 1



## MEMORANDUM

DATE: May 15, 2023

TO: Amy Pepper | City of Wilsonville

FROM: Jenna Bogert, PE | DKS Associates

SUBJECT: Wilsonville PGE Substation Trip Generation

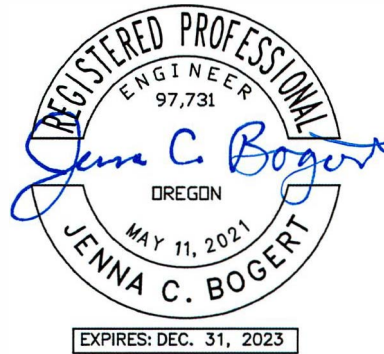

P21123-021

This memorandum documents the vehicle trip generation estimate and site plan review for the proposed PGE substation located at 27601 SW Parkway Avenue in Wilsonville, Oregon. The applicant proposes to develop the vacant parcel into a substation for Portland General Electric (PGE). The substation will consist of control buildings and electrical transformers; the site will not contain any office space or any other trip-generating land uses. Occasional maintenance on the site is expected, but will be infrequent, as the site will be predominantly managed remotely. An existing substation is located just ¼ mile to the south on SW Parkway Avenue. This existing site is expected to remain in operation.

The purpose of this memorandum is to determine how much additional traffic the proposed land use would generate through the City’s transportation system, if any, and provide a review of the site plan and its consistency with City transportation standards (access spacing, street frontage improvements, etc.).

### VEHICLE TRIP GENERATION

Trip generation is the method used to estimate the number of vehicles that are added to the roadway network by the proposed project during a specified period (e.g., PM peak hour). Typically, trip generation for sites are estimated using trip rates provided by the Institute of Transportation Engineers (ITE) *Trip Generation Manual*.<sup>1</sup>

However, this type of land use is not consistent with any of the listed land uses in the *Trip Generation Manual*. Therefore, trip generation for the site was based on information provided by the project applicant. Based on the information provided, the project is anticipated to generate an average of 0 daily and 0 PM peak hour vehicle trips as the site will contain electrical equipment only and no office space or other trip generating land uses. Although there is no average daily trip generation, some trip generation is expected on a monthly basis as two separate trips to the site for maintenance are expected every 45 – 60 days.

<sup>1</sup> Trip Generation Manual, 11th Edition, Institute of Transportation Engineers, 2021.



## SITE PLAN REVIEW

---

The following section discusses the site access spacing, sight distance, and street frontage improvements for the proposed project. The site plan is provided as an attachment.

### SITE ACCESS SPACING

The site plan for the substation proposes two new driveways (accesses) on SW Parkway Avenue that will be gated.

Access spacing requirements for the City of Wilsonville are provided in the City's Public Works Construction Standards<sup>2</sup> and are based on the street classification. SW Parkway Avenue is classified as a minor arterial and therefore has a minimum access spacing of 600 feet and a desired spacing of 1,000 feet. Accesses include driveways, alleys, and streets. The total distance between the two proposed driveways is 310 feet, which does not meet the minimum access spacing standard. Because the site frontage is 525 feet in length and there are existing driveways on adjacent parcels that are located close to the edge of the project site, 600 feet access spacing cannot be achieved.

Because the project site generates such a low volume of vehicle trips (see *Vehicle Trip Generation*), the currently proposed accesses locations and spacings are not a safety concern as currently proposed on the site plan. Although the accesses are not safety concerns, a deviation from the Public Works Standards will need to be requested by the project applicant.

### SIGHT DISTANCE

Sight distance at the accesses is still important for safety even though the project site will generate a very low volume of vehicles trips.

Based on the City's Public Works Construction Standards<sup>3</sup>, adequate sight distance should be provided at all proposed driveways. Objects (e.g., buildings, fences, walls, or vegetation) located near the intersections may inhibit sight distance for drivers attempting to turn out of a driveway onto the SW Parkway Avenue. With a posted speed limit of 45 miles per hour on SW Parkway Avenue, the sight distance requirement for the two driveways is 500 feet for vehicles turning left from the driveways.<sup>4</sup>

Based on a site visit and preliminary evaluation, the sight distances at the two proposed driveways appear to exceed the 500 feet sight distance requirement. There is an existing tree along the project frontage that will be preserved. As long as the southernmost site access is located as far to the south of the tree as possible, sight distance will be maximized at that access and the existing tree will not block the driver's line of vision looking north.

Prior to occupancy, sight distance at any existing or proposed driveways will need to be verified, documented, and stamped by a registered professional Civil or Traffic Engineer licensed in the State of Oregon to assure that buildings, signs, or landscaping does not restrict sight distance.

---

<sup>2</sup> Section 2, Table 2.12, Public Works Construction Standards, City of Wilsonville, Revised September 2017.

<sup>3</sup> Section 2, Table 2.12, Public Works Construction Standards, City of Wilsonville, Revised September 2017.

<sup>4</sup> Chapter 9, Tables 9-7 & 9-9, A Policy on Geometric Design of Highways and Streets, AASHTO, 7<sup>th</sup> Edition, 2018.

## STREET FRONTAGE IMPROVEMENTS

SW Parkway Avenue along the project site frontage should be consistent with the City of Wilsonville’s minor arterial cross section standard. SW Parkway Avenue is a Minor Arterial and the street cross-section standard for Minor Arterials is shown in Figure 3-7 in the City TSP and to the right.<sup>5</sup>

Today, Parkway Avenue fronting the project site has two travel lanes with a center turn lane, bike lanes (5’ wide), and sidewalks (6’ wide).

Per discussions with the City, there are no additional Minor Arterial street improvements along the project frontage that will be required of the applicant.

## SUMMARY

Key findings for the proposed PGE substation are as follows:

- The project is anticipated to generate an average of 0 daily trips and 0 PM peak hour trips as the site will contain electric equipment only and no office space or other trip generating uses.
- The proposed site accesses do not meet the City’s access spacing requirements. However, because the project site generates such a low volume of vehicle trips, the proposed access spacing is not a safety concern. A deviation from Public Works standards will need to be requested by the project applicant.
- Based on a preliminary evaluation, sight distance at the two proposed site driveway locations meets sight distance requirements.
- Prior to occupancy, sight distance at any existing or proposed driveways will need to be verified, documented, and stamped by a registered professional Civil or Traffic Engineer licensed in the State of Oregon to assure that buildings, signs, or landscaping does not restrict sight distance.
- No additional street improvements along the project frontage on SW Parkway Avenue will be required of the project applicant.

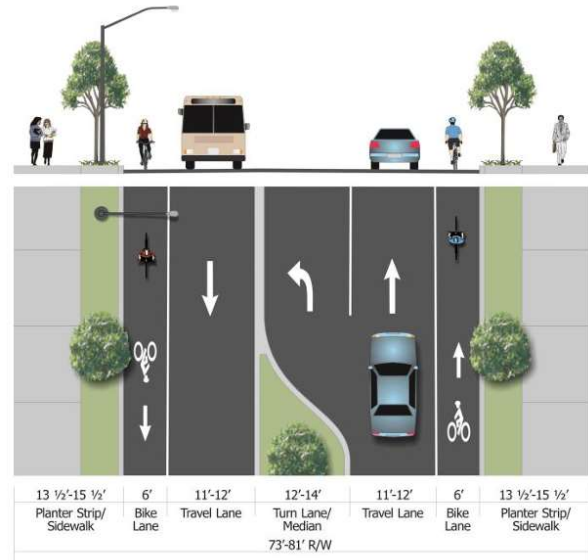

**MINOR ARTERIAL CROSS SECTION**

<sup>5</sup> Chapter 3: The Standards, Wilsonville Transportation System Plan, Amended November 2020.



# Preliminary Storm Drainage Report

## PGE Memorial Substation

Prepared for: Portland General Electric  
Prepared by: KPFF Consulting Engineers  
Project Manager: Josh Lighthipe, PE  
Design Engineers: Tyson Leggate & Justin Collinson

Revised October 2023 | KPFF Project #2200448

#### KPFF'S COMMITMENT TO SUSTAINABILITY

As a member of the US Green Building Council, KPFF is committed to the practice of sustainable design and the use of sustainable materials in our work.

When hardcopy reports are provided by KPFF, they are prepared using recycled and recyclable materials, reflecting KPFF's commitment to using sustainable practices and methods in all of our products.

# Table of Contents

Project Overview .....	3
Existing Conditions .....	3
<i>Wetlands and Sensitive Areas</i> .....	4
<i>Site Soils</i> .....	4
<i>Infiltration Testing</i> .....	5
Developed Conditions .....	5
<i>CoW Storm Requirements &amp; BMP Sizing Tool</i> .....	5
<i>Conveyance</i> .....	8
<i>Downstream Analysis</i> .....	8
<i>Emergency Overflow (100-year storm)</i> .....	8
<i>Maintenance Strategy</i> .....	8

## Tables and Figures

Figure 1: Vicinity Map .....	3
Figure 2: Watershed Map .....	4
Table 1: Catchment and Facility Areas .....	6
Table 2a-Detention Pond A Stage Storage Table .....	7
Table 2b-Detention Pond B Stage Storage Table .....	7
Table 3a: Catchment A - Pre vs. Post-Development Flow Rates .....	7
Table 3b: Catchment B - Pre vs. Post-Development Flow Rates .....	8

## **Appendices**

### Appendix A

A1- Existing Areas

A2- Proposed Area & Storm System Maps

A3 – Wetland Map

### Appendix B

B1- WES BMP Sizing Report

B2- Email from ODOT confirming Detention Requirements

B3- Hydraflow Detention Calculations

B4- Conveyance Calculations\*

### Appendix C

C1-Hydrologic Soil Group

C2- Rainfall Distribution

### Appendix D

Geotechnical Reports

### Appendix E

Plans

### Appendix F

Downstream Analysis

### Appendix G

Operations & Maintenance Manual\*

*\*To be provided in final version of report*

## Project Overview

PGE is proposing the development of a new substation adjacent to Parkway Ave, North of Boeckman Road. Building and grading permits are required. The project is located at 27601 SW Parkway Avenue, Tax lot ID 31W11 00800, Record No 805196 and zoning code Planned Development Industrial (PDI). See Figure 1 below for a vicinity map of the project site.

The area to be developed is approximately 185,272 SF of vacant land. A 6.5-foot right-of-way dedication is required along the project frontage which will make the developed project site area 181,874 SF.

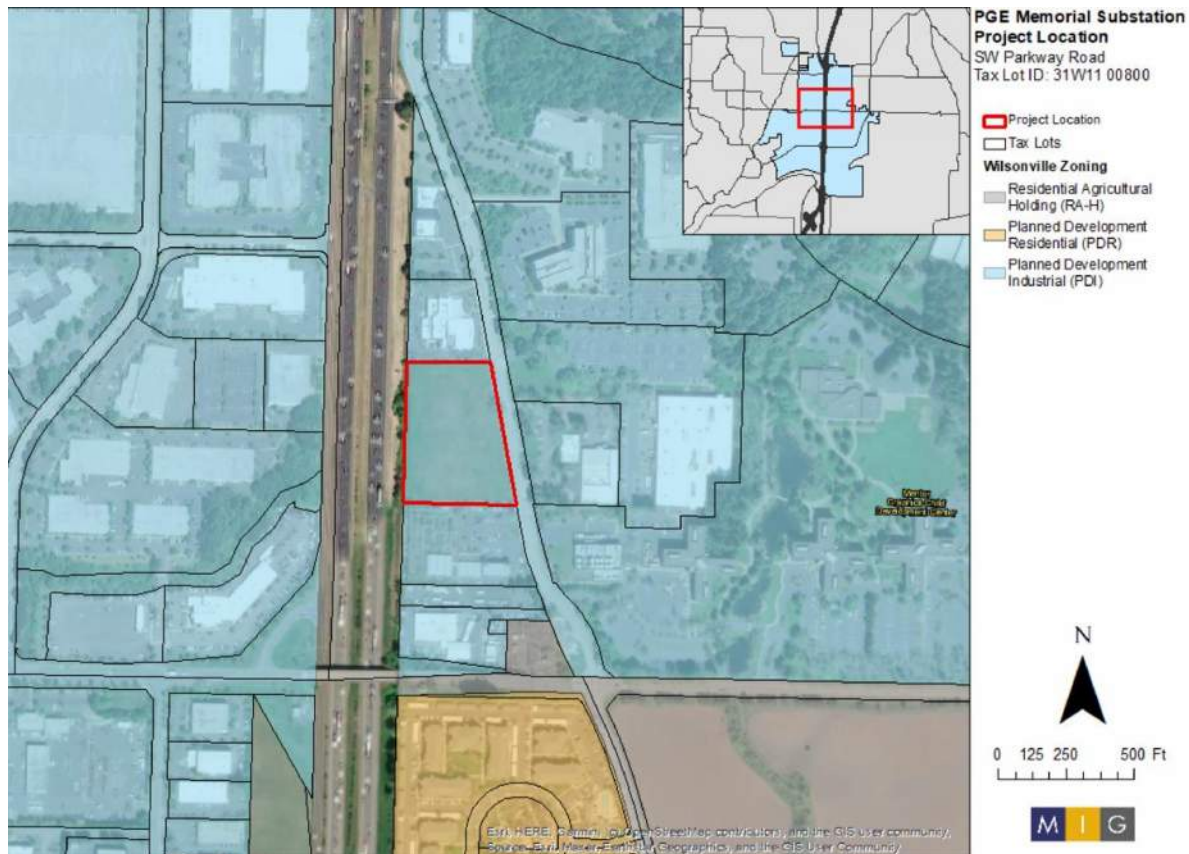

Figure 1: Vicinity Map

## Existing Conditions

The vacant property slopes generally east to west away from Parkway Avenue and toward Interstate 5 right-of-way. The site is within the Coffee Lake Creek Sub-Watershed and is bisected by Sub-basin 1726 & 4012. See Figure 2.

There is no offsite drainage onto the property. There is an underground 42-inch diameter CMP public storm main that flows diagonally through the northwest corner of the site and a separate underground 42-inch diameter CMP public storm main that runs west just south of the south property line. Both public storm

mains outfall into conveyance ditches within the Interstate 5 right-of-way. Each conveyance ditch flows to a culvert that flows under the highway west and ultimately discharges to the Willamette River.

Abutting properties are also zoned as PDI, these properties include AI's Garden & Home and Grace Chapel, consists of primarily impervious hardscape, building and minimal landscape.

See Appendix A, Exhibit A1 for an existing areas map.

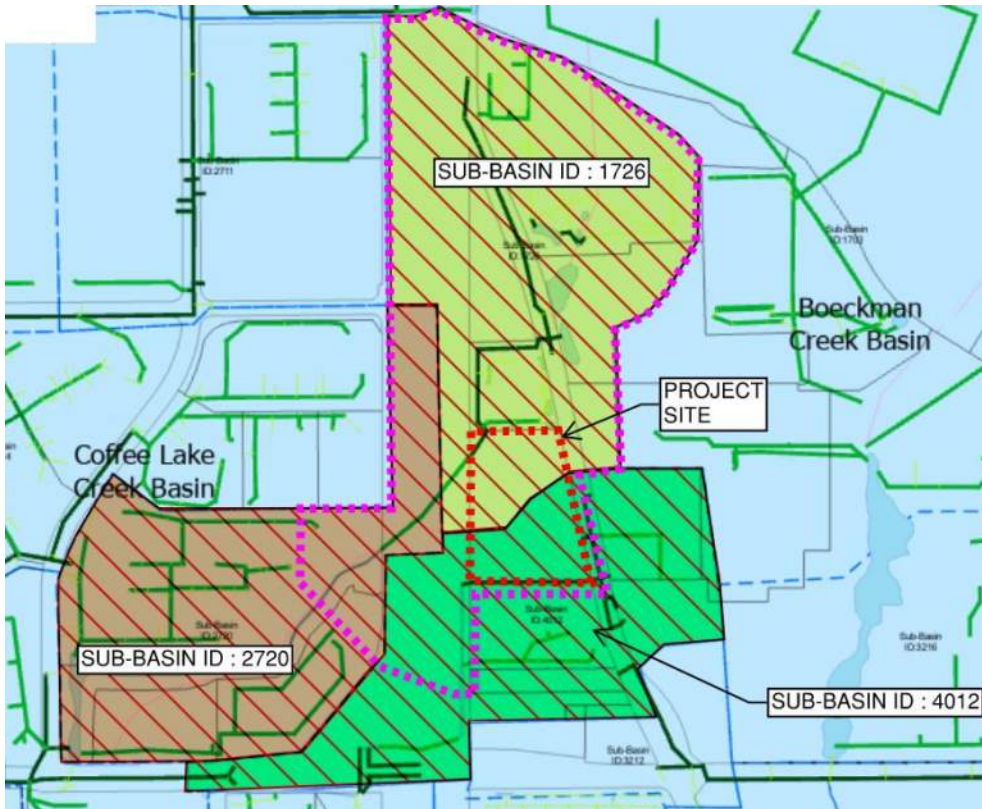

Figure 2: Watershed Map

### *Wetlands and Sensitive Areas*

A draft wetland delineation report has been prepared and submitted to DSL for review and their response is pending.

The draft report determined that of the three wetland-like areas found, only Wetland B & C should be considered a jurisdictional wetland. The project does not propose a disturbance to those areas. A copy of the wetland map from the draft report is included on Appendix A, Exhibit A3 for reference.

### *Site Soils*

The site soils are predominantly Aloha Silt Loam per the NRCS Soils Survey mapping, classified as Hydrologic Soil Group C/D. These soils are somewhat poorly drained, with a moderately high runoff potential and limited capacity for infiltration. Web Soil Survey of the project site are provided as Appendix C.

The CN number used for pre-developed conditions is 80, based on hydraulic soil group D with good condition grass cover >75%, which is how the site appears today.

### *Infiltration Testing*

Infiltration testing was attempted at 2 locations, as indicated in March 2023. Each test performed encountered water in the test pit or there was minimal infiltration over a 24-hour period. Due to the nature of the existing soil and low infiltration rate, the stormwater facilities are designed with an infiltration rate of 0-inches/hour. The Geotech report by Shannon & Wilson dated March 22, 2023, containing the infiltration testing results are included in Appendix D.

## **Developed Conditions**

The project site's developable area is extremely constrained due to the needed area for equipment, safe setbacks to operate equipment and maintenance access around the south and west sides to access major transmission towers. The proposed placement of storm water facilities is on the northwest and southwest corners of the lot. The two proposed stormwater bioretention detention ponds (based on CoW Std Dwg ST-6060) will filter and detain stormwater through a flow control manhole (based on CoW Std Dwg S-2049) before discharging to the existing public storm mains that flows west into the ODOT right-of-way. Each flow control manhole is located within 10-feet of a maintenance access road.

The north half of the post-developed site drains to the northwest pond and this area is designated Catchment A, which is similar in size to the onsite portion of sub-basin 1726.

The southern half of the post-developed site drains to the southwest pond and this area is designated Catchment B, which is similar in size to the onsite portion of sub-basin 4012.

See Appendix A - Exhibit A2: Proposed Areas & Storm System map and Appendix E - Sheet C2: Grading and Utility Plan for the basin areas, detention pond and storm system.

The project team has notified ODOT of the intention to discharge the developed site stormwater into this ODOT conveyance system and they have provided approval criteria for the project to do so. Their approval criteria are to provide "post" development flow control to rates not exceeding the "pre" rates to for the 2-, 10-, 25- & 50-year storm events. See Appendix B3 for a copy of that email correspondence.

### *CoW Storm Requirements & BMP Sizing Tool*

Stormwater management for the project area will be provided using the 2015 City of Wilsonville Stormwater and Surface Water Design and Construction Standards. This includes providing treatment and flow control of stormwater prior to discharging the site using Low Impact Development (LID) facilities. To meet the City of Wilsonville stormwater requirements, the WES BMP Sizing Tool is used to determine the minimum detention pond size for the discharge management area (catchment).

Specifically, the facility sizing factors ensure treatment of 80 percent of the average annual runoff, as well as peak flow duration matching for flows ranging from 42 percent of the 2-year peak flow to the 10-year peak flow.

The following statistics were used in the WES BMP sizing tool:

- Hydrologic soil group D soils.
- Pre-existing conditions are considered grass to reflect the agricultural terrain.
- Developed conditions that drain to the rain garden are mostly gravel (crushed aggregate).

As noted previously there are no offsite drainage areas flowing onto the property, so catchment areas are limited to the property limits. The Proposed Area map illustrates the catchment area associated with the proposed stormwater facility. The proposed facility is summarized below in Table 1 and shown in Appendix A, Exhibit A2 – Proposed Areas & Storm System Map.

Table 1: Catchment and Facility Areas

Catchment Area	Sub-Catchment Area	Source (road, landscape or other)	New Imp. Area (SF)	Landscape Area (SF)	Total Area (AC)		
			CN= 91	80			
A	A1	Gravel	87,473		87,473		
	A2	Landscape		7,469	7,469		
	DP-A	Detention Pond-A		2,719	2,719		
	<b>Totals :</b>		<b>87,473</b>	<b>10,188</b>	<b>97,661</b>	<b>2.24 Acres</b>	<b>89.9 Weighted CN</b>
B	B1	Gravel	57,560		57,560		
	B2	Landscape		8,445	8,445		
	B3	Detention Pond-B		1,767	1,767		
	<b>Totals :</b>		<b>57,560</b>	<b>10,212</b>	<b>67,772</b>	<b>1.56 Acres</b>	<b>89.3 Weighted CN</b>

Both catchments A and B used the Detention Pond facility option in the BMP sizing tool to determine the top area and it solved for pond depth with 3:1 side slopes. For Detention Pond A and B, it calculated the surface depth to be 2.05-feet deep and 1.97-feet deep respectively. Each has an additional 3-feet of below grade depth in the soil growing media and bottom rock layers. The calculations and output from the WES BMP Sizing Report are provided in Appendix B1.

However, since the ODOT detention criteria also required detention modeling for the 25- & 50-year storm events (in addition to the 2- & 10-year events that the BMP tool already addressed). A separate modeling analysis was performed using Hydraflow Hydrographs Extensions for Autodesk® to model those storm events.



The stage storage table for the proposed detention ponds used in that modeling is shown below in Table 2a & 2b.

Table 2a-Detention Pond A Stage Storage Table

Stage	Elevation	Surface Area	Void Ratio	Incremental Storage	Cumulative Storage
FT		SF		CF	CF
0.00	211.50	0	0.3	0	0
1.50	213.00	213	0.3	48	48
3.00	214.50	678	1.0	668	716
4.00	215.50	1167	1.0	922	1638
5.00	216.50	1744	1.0	1456	3094
6.00	217.50	2380	1.0	2062	5156
6.50	218.00	2719	1.0	1275	6431

Table 2b-Detention Pond B Stage Storage Table

Stage	Elevation	Surface Area	Void Ratio	Incremental Storage	Cumulative Storage
FT		SF		CF	CF
0.00	213.00	4	0.0	0	0
1.50	214.50	159	0.3	37	37
3.00	216.00	534	0.3	156	193
4.00	217.00	890	1.0	712	904
5.00	218.00	1300	1.0	1095	1999
6.00	219.00	1767	1.0	1533	3533

The results of the ODOT required flow-control are shown below in Table 3a and 3b.

Table 3a: Catchment A - Pre vs. Post-Development Flow Rates

Storm Event	Post-developed Flow Control Target	Pre-developed Basin A Flow Rate (cfs)	Target Flow Rate (cfs)	Post-developed Catchment A Flow Rate (cfs)
2-year, 24-hour	100% pre-developed	0.66*	0.66*	0.54*
10-year, 24-hour	100% pre-developed	0.98*	0.98*	0.93*
25-year, 24-hour	100% pre-developed	0.86**	0.86**	0.83**
50-year, 24-hour	100% pre-developed	1.01**	1.01**	0.91**
100-year, 24-hour	N/A	1.1**	N/A	0.94**

\*Per BMP sizing tool, see Appendix B1

\*\* Per Hydraflow Detention Calculations, see Appendix B3

Table 3b: Catchment B - Pre vs. Post-Development Flow Rates

Storm Event	Post-developed Flow Control Target	Pre-developed Basin B Flow Rate (cfs)	Target Flow Rate (cfs)	Post-developed Catchment B Flow Rate (cfs)
2-year, 24-hour	100% pre-developed	0.44*	0.44*	0.21*
10-year, 24-hour	100% pre-developed	0.43*	0.43*	0.64*
25-year, 24-hour	100% pre-developed	0.88**	0.88**	0.74**
50-year, 24-hour	100% pre-developed	1.03**	1.03**	0.80**
100-year, 24-hour	N/A	1.1**	N/A	0.84**

\*Per BMP sizing tool, see Appendix B1

\*\* Per Hydraflow Detention Calculations, see Appendix B3

### Conveyance

Conveyance of the site storm system will be calculated using the Rational Method per section 301.5.03 of the 2015 City of Wilsonville Stormwater & Surface Design & Construction Standards. This includes the rainfall intensity per Table 3.4 with a 25-year design storm event. Assumptions including runoff coefficients and times of concentration are determined per the Oregon Department of Transportation Hydraulics Manual, Chapter 7. These calculations will be provided in the final version of this report.

### Downstream Analysis

Per section 301.5.01 of the 2015 City of Wilsonville Stormwater and Surface Water Design and Construction Standards, an analysis of the downstream drainage system has been performed to confirm that it has the capacity to convey the 25-year design storm. See Appendix F for the memo with attachments documenting this analysis.

### Emergency Overflow (100-year storm)

In the case of flows greater than the freeboard capacity of the detention pond, an emergency spillway in the east edge of the top of pond will allow it to safely overflow into the ODOT ROW. However, current modeling shows that the pond will not overflow during the 100-year event.

### Maintenance Strategy

The maintenance strategy for the stormwater facilities will require inspections and regular maintenance as described in the Operation and Maintenance Plan to be included in Appendix G in the final version of this report.

Detention Ponds are Wilsonville standard facilities and therefore will follow the inspection and maintenance procedures as described in the City's Stormwater and Grading Design Standards and included in the Operations and Maintenance Plan.

10102200448-kb

## **Appendix A**

A1- Existing Areas

A2- Proposed Area & Storm System Maps

A3 – Wetland Map

Page intentionally left blank for double-sided printing.

File: N:\p\2022\200448-PGE-Memorial-Substation\PRO-INFO\Planning-Design\Storm-Basin-Maps\20448-Basin-Map.dwg TAB:EX  
Plotted: 10/23/23 at 9:33am By: JCollinson

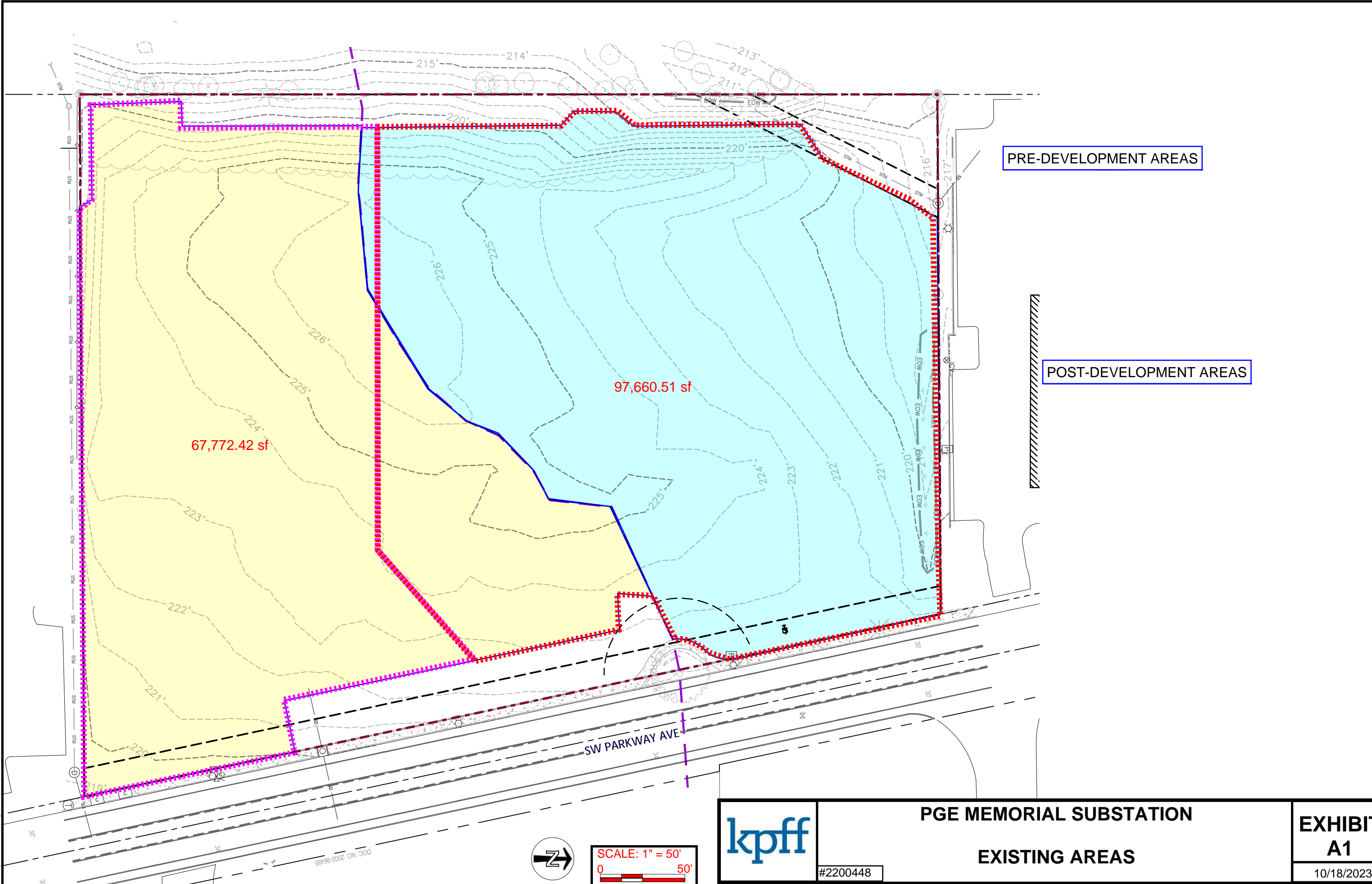

	PGE MEMORIAL SUBSTATION	EXHIBIT
		A1
#2200448	EXISTING AREAS	10/18/2023



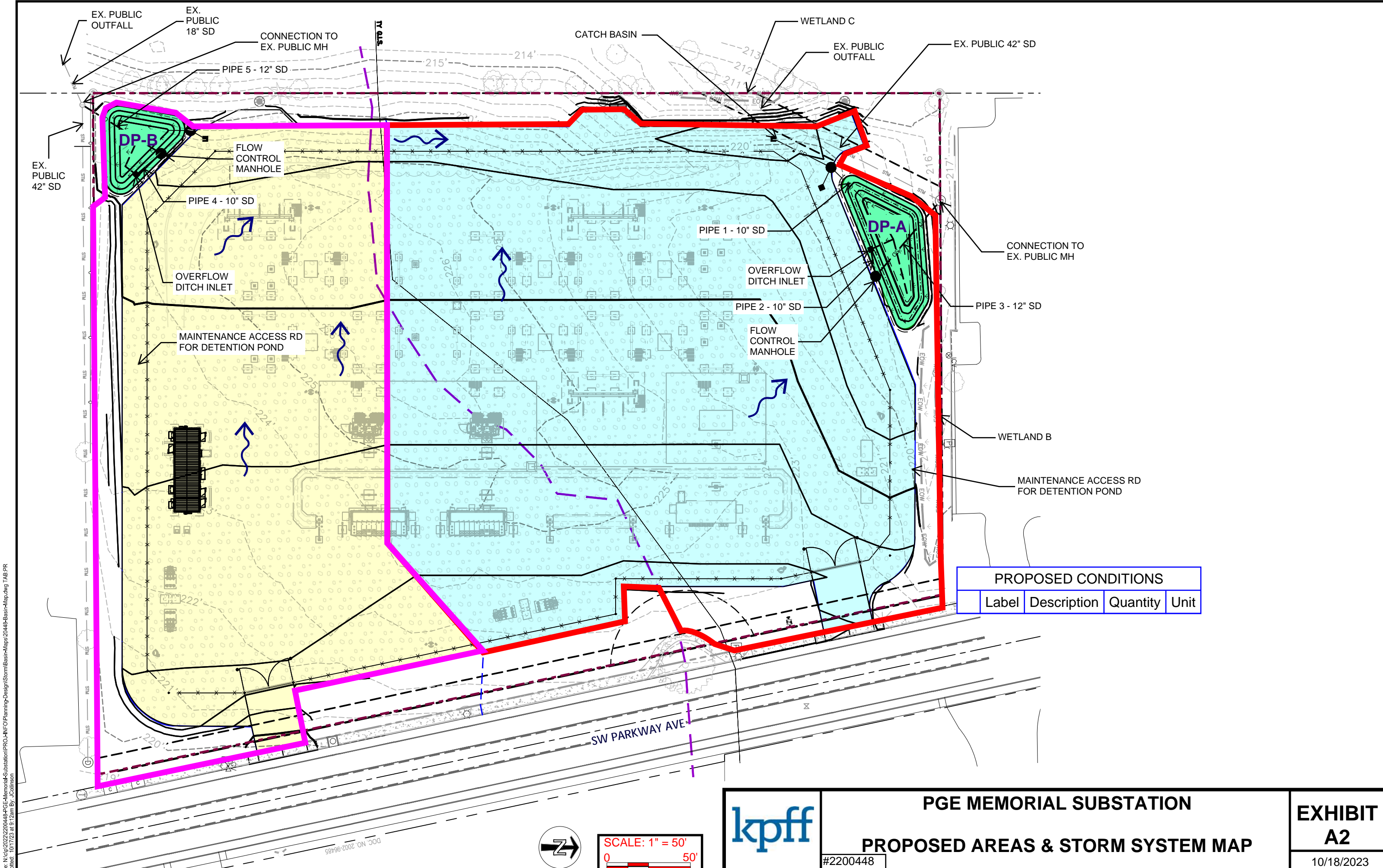

PROPOSED CONDITIONS			
Label	Description	Quantity	Unit

File: N:\p\2022\200448-PGE-Memorial-Substation\PRO-INFO\Planning\Design\Storm\Basin-Maps\20448-Basin-Map.dwg TAB:PR  
 Plotted: 10/17/23 at 8:12am By: JCollinson



SCALE: 1" = 50'  
 0 50'

	<b>PGE MEMORIAL SUBSTATION</b>		<b>EXHIBIT A2</b>
	<b>PROPOSED AREAS &amp; STORM SYSTEM MAP</b>		
#2200448			10/18/2023

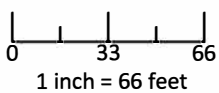
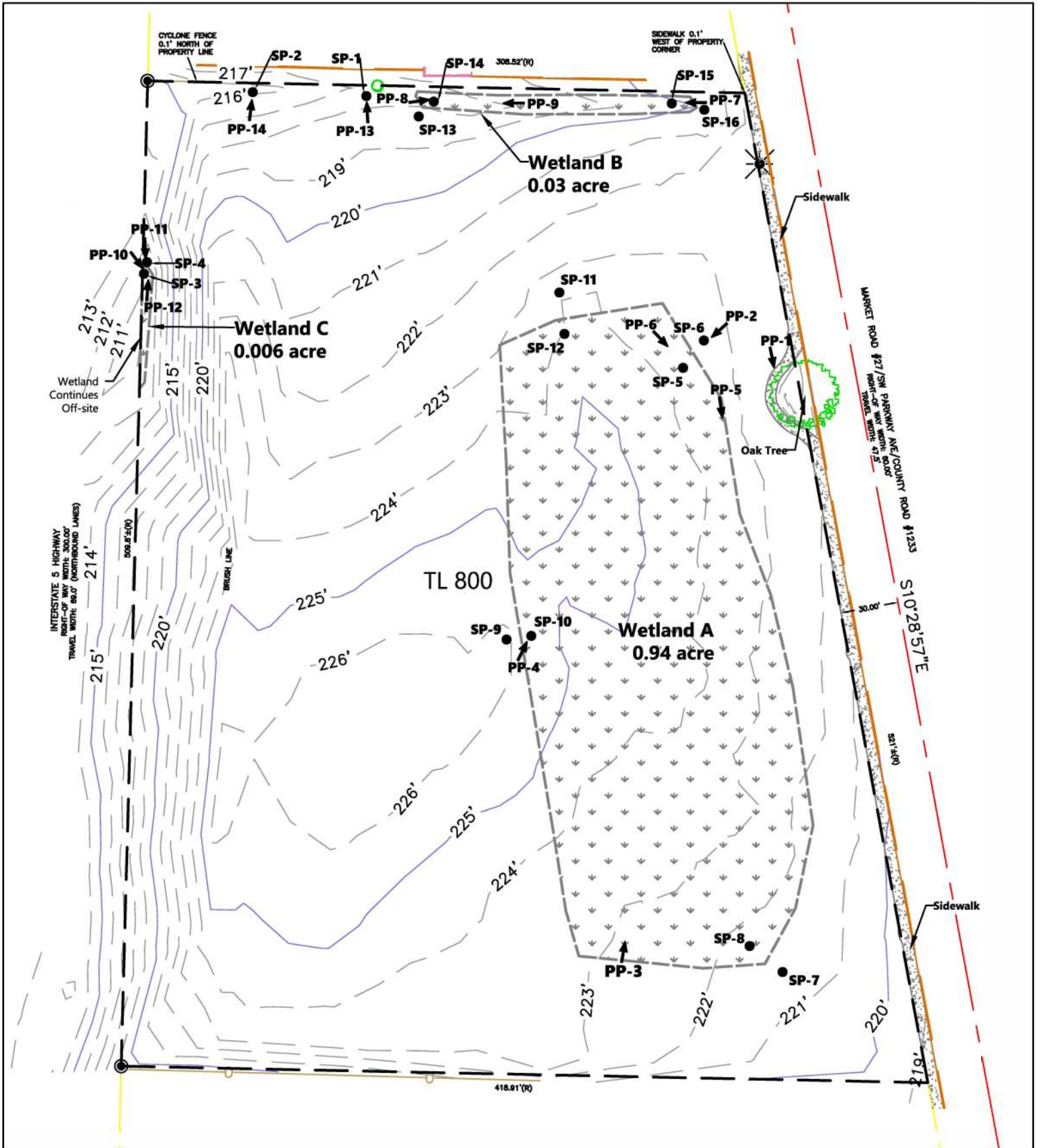

- Study Area
- Wetland Boundary
- SP-1 Sample Plot
- ▲ PP-1 Photo Point

Sample plot locations and wetland boundaries were recorded in ArcGIS Collector with an EOS Arrow 100 GNSS Receiver capable of achieving sub-meter accuracy.

PGE Memorial Substation

Figure 6: Wetland Map



Page intentionally left blank for double-sided printing.



## **Appendix B**

B1- WES BMP Sizing Report

B2- Email from ODOT confirming Detention Requirements

B3- Hydraflow Detention Calculations

B4- Conveyance Calculations\*

Page intentionally left blank for double-sided printing.

WES BMP Sizing Software Version 1.6.0.2, May 2018

## WES BMP Sizing Report

## Project Information

Project Name	PGE Memorial
Project Type	Addition
Location	
Stormwater Management Area	4733
Project Applicant	
Jurisdiction	SWMACC

## Drainage Management Area

Name	Area (sq-ft)	Pre-Project Cover	Post-Project Cover	DMA Soil Type	BMP
A	87,473	Grass	CrushedAggregate	D	DP-A
B	57,560	Grass	CrushedAggregate	D	DP-B

## LID Facility Sizing Details

## Pond Sizing Details

Pond ID	Design Criteria(1)	Facility Soil Type	Max Depth (ft)(2)	Top Area (sq-ft)	Side Slope (1:H)	Facility Vol. (cu-ft)(3)	Water Storage Vol. (cu-ft)(4)	Adequate Size?
DP-A	FCWQT	D1	5.05	1,725.0	3	3,900.6	3,115.5	Yes
DP-B	FCWQT	D1	4.97	1,300.0	0	6,461.0	4,121.0	Yes

1. FCWQT = Flow control and water quality treatment, WQT = Water quality treatment only

2. Depth is measured from the bottom of the facility and includes the three feet of media (drain rock, separation layer and growing media).

3. Maximum volume of the facility. Includes the volume occupied by the media at the bottom of the facility.

4. Maximum water storage volume of the facility. Includes water storage in the three feet of soil media assuming a 40 percent porosity.

# Custom Pond Geometry Configuration

Pond ID: DP-A

Design: FlowControlAndTreatment

Shape Curve

Depth (ft)	Area (sq ft)	Discharge (cfs)
NaN	NaN	NaN

Flow Frequency Chart

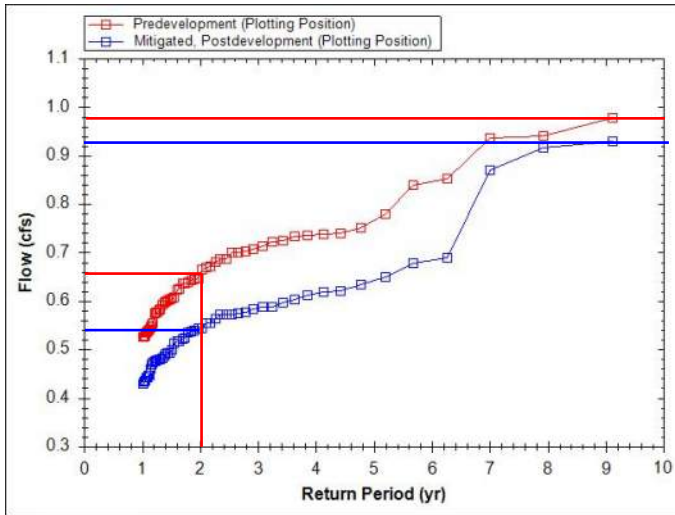

Flow Duration Chart

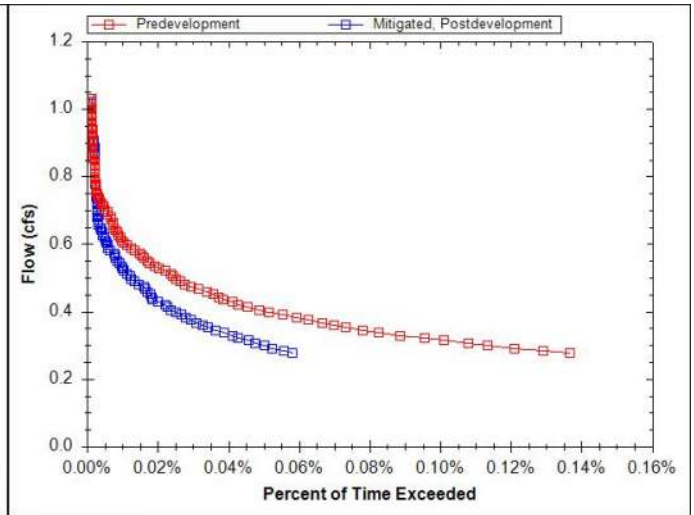

# Simple Pond Geometry Configuration

Pond ID: DP-B

Design: FlowControlAndTreatment

## Shape Curve

Depth (ft)	Area (sq ft)
5.0	1,300.0

## Outlet Structure Details

Lower Orifice Invert (ft)	0.0
Lower Orifice Dia (in)	1.8
Upper Orifice Invert(ft)	3.3
Upper Orifice Dia (in)	3.8
Overflow Weir Invert(ft)	4.0
Overflow Weir Length (ft)	6.3

Flow Frequency Chart

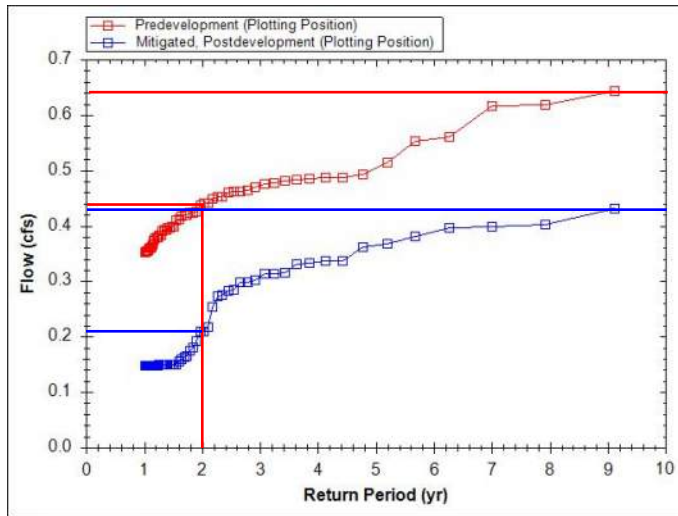

Flow Duration Chart

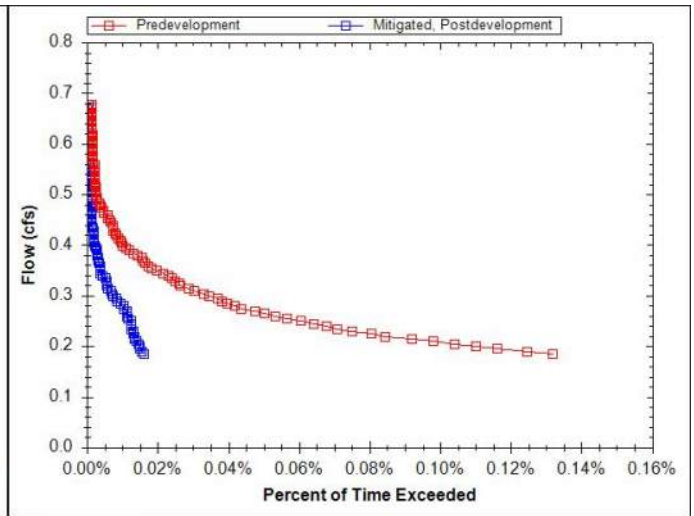

## Josh Lighthipe

---

**From:** BABICKY William A \*Alan <Alan.BABICKY@odot.oregon.gov>  
**Sent:** Thursday, June 22, 2023 1:37 PM  
**To:** Josh Lighthipe; HALL Larry H  
**Cc:** jordan.messinger@pgn.com; Justin Collinson; Tyson Leggate; Andrew Yaden; KEVE Zoe; MCDONALD David L  
**Subject:** RE: PGE Substation Storm Sewer connection into ODOT Conveyance in Wilsonville - confirmation revised

Hi Josh,

That is correct, flow control up to the 50-year storm event for post development is required. The expectation is the peak flow for the 2, 10, 25 and 50 year to not exceed pre development.

Thanks

Alan Babicky, P.E.  
 Region 1 Hydraulic Engineer  
 Oregon Department of Transportation  
 123 NW Flanders St., Portland, OR 97209  
 Office: (503) 731-8441 | Cell: (503) 312-8509

---

**From:** Josh Lighthipe <Josh.Lighthipe@kpff.com>  
**Sent:** Monday, June 19, 2023 10:16 AM  
**To:** HALL Larry H <Larry.H.HALL@odot.oregon.gov>; BABICKY William A \*Alan <Alan.BABICKY@odot.oregon.gov>  
**Cc:** jordan.messinger@pgn.com; Justin Collinson <justin.collinson@kpff.com>; Tyson Leggate <Tyson.Leggate@kpff.com>; Andrew Yaden <andrew.yaden@pgn.com>; KEVE Zoe <Zoe.KEVE@odot.oregon.gov>; MCDONALD David L <David.L.MCDONALD@odot.oregon.gov>  
**Subject:** RE: PGE Substation Storm Sewer connection into ODOT Conveyance in Wilsonville - confirmation revised

Some people who received this message don't often get email from [josh.lighthipe@kpff.com](mailto:josh.lighthipe@kpff.com). [Learn why this is important](#)

This message was sent from outside the organization. Treat attachments, links and requests with caution. Be conscious of the information you share if you respond.

Larry and Alan,

For our records and to inform City of Wilsonville “Evidence of correspondence with ODOT should be submitted with the Land Use application”

Below is a revised recap our understanding, **please confirm or provide further clarification.** Thanks!

### **Summary of Storm discussion:**

*Drainage of stormwater runoff from the proposed PGE Substation project is acceptable.*

*However per ODOT Hydraulic Manual there is a requirement to provide flow control of the peak flow rate from the **50-year** post development condition to the **50-year** pre-construction condition for detention facilities that drain to culverts that flow under Interstate-5. This requirement is identified in Chapter 12 section 12.5.1.1. B.*

*Below is an excerpt snapshot from that section from the manual.*

*We understand that ODOT will need to review and approve the final stormwater design and report with supporting flow control calculations prior to approval.*

### 12.5.1.1 Storms, Runoff Rates, Release Rates, and Storage Volumes

**Flood Flow Control Design Storm(s)** - An essential part of storage basin design is to analyze the design storm events. These events are often modeled as relationships of runoff versus time and described by hydrographs. In almost all cases, there are two design storm hydrographs, and they show the flow that occurs at the location of the inlet to the facility. One hydrograph describes the runoff versus time relationship for the upstream drainage basin before the proposed development. The other hydrograph describes the runoff versus time relationship at the same location after the proposed development.

*Note: In almost all cases, the post-construction hydrograph will show an increased peak discharge when compared to the pre-construction hydrograph. If this does not occur, the storm modeling should be carefully reviewed for errors.*

The design storm(s) recurrence interval(s) are the longer of the values listed below unless a more stringent recurrence interval is required by ODOT, federal, state, regional, or local agencies.

A. For detention facilities which serve 5 acres or less and discharge directly to and are physically connected to storm sewers or which discharge to ditches which do not lead directly to cross culverts or inlets:

- 10-year.

B. For detention facilities which serve 5 acres or less and do not discharge directly to storm sewers (This includes systems that utilize ditches and lead directly to cross culverts or inlets.) use one of the following:

- 25-year when the average daily traffic (ADT) volume is less than 750, or
- 50-year when the ADT is 750 or greater.

*Note: ADT values are listed annually in the ODOT Transportation Volume Tables.*

April 2014

ODOT Hydraulics Manual

**Josh Lighthipe** Associate, PE (OR, WA), LEED AP

Senior Project Manager | KPFF Portland Civil + Survey  
 O 503.542.3860 D 503.542.3840 M 971.235.2317

**From:** HALL Larry H <[Larry.H.HALL@odot.oregon.gov](mailto:Larry.H.HALL@odot.oregon.gov)>

**Sent:** Friday, June 16, 2023 1:56 PM

**To:** Josh Lighthipe <[Josh.Lighthipe@kpff.com](mailto:Josh.Lighthipe@kpff.com)>

**Cc:** [jordan.messinger@pgn.com](mailto:jordan.messinger@pgn.com); Justin Collinson <[justin.collinson@kpff.com](mailto:justin.collinson@kpff.com)>; Tyson Leggate <[Tyson.Leggate@kpff.com](mailto:Tyson.Leggate@kpff.com)>; Andrew Yaden <[andrew.yaden@pgn.com](mailto:andrew.yaden@pgn.com)>; BABICKY William A \*Alan <[Alan.BABICKY@odot.oregon.gov](mailto:Alan.BABICKY@odot.oregon.gov)>; KEVE Zoe <[Zoe.KEVE@odot.oregon.gov](mailto:Zoe.KEVE@odot.oregon.gov)>; MCDONALD David L <[David.L.MCDONALD@odot.oregon.gov](mailto:David.L.MCDONALD@odot.oregon.gov)>

**Subject:** RE: PGE Substation Storm Sewer connection into ODOT Conveyance in Wilsonville - confirmation

Josh/ Jordan

In the meeting Alan Babicky discussed it discharges to a culvert across I-5 so the 50 year applies

Larry



# Hydraflow Table of Contents

20230727-PGE-memorial-DP-A-&amp;-B.gpw

Hydraflow Hydrographs Extension for Autodesk® Civil 3D® by Autodesk, Inc. v2022

Tuesday, 10 / 24 / 2023

<b>Watershed Model Schematic.....</b>	<b>1</b>
<b>Hydrograph Return Period Recap.....</b>	<b>2</b>
<b>2 - Year</b>	
<b>Summary Report.....</b>	<b>3</b>
<b>Hydrograph Reports.....</b>	<b>4</b>
Hydrograph No. 1, SBUH Runoff, Pre-Dev-A.....	4
Hydrograph No. 2, SCS Runoff, Post-Dev-A.....	5
Hydrograph No. 3, Reservoir, A thru DP-A.....	6
Pond Report - DP-A.....	7
Hydrograph No. 4, SBUH Runoff, Pre Dev-B.....	8
Hydrograph No. 5, SCS Runoff, Post-Dev-B.....	9
Hydrograph No. 6, Reservoir, B thru DP-B.....	10
Pond Report - DP-B.....	11
<b>10 - Year</b>	
<b>Summary Report.....</b>	<b>12</b>
<b>Hydrograph Reports.....</b>	<b>13</b>
Hydrograph No. 1, SBUH Runoff, Pre-Dev-A.....	13
Hydrograph No. 2, SCS Runoff, Post-Dev-A.....	14
Hydrograph No. 3, Reservoir, A thru DP-A.....	15
Hydrograph No. 4, SBUH Runoff, Pre Dev-B.....	16
Hydrograph No. 5, SCS Runoff, Post-Dev-B.....	17
Hydrograph No. 6, Reservoir, B thru DP-B.....	18
<b>25 - Year</b>	
<b>Summary Report.....</b>	<b>19</b>
<b>Hydrograph Reports.....</b>	<b>20</b>
Hydrograph No. 1, SBUH Runoff, Pre-Dev-A.....	20
Hydrograph No. 2, SCS Runoff, Post-Dev-A.....	21
Hydrograph No. 3, Reservoir, A thru DP-A.....	22
Hydrograph No. 4, SBUH Runoff, Pre Dev-B.....	23
Hydrograph No. 5, SCS Runoff, Post-Dev-B.....	24
Hydrograph No. 6, Reservoir, B thru DP-B.....	25
<b>50 - Year</b>	
<b>Summary Report.....</b>	<b>26</b>
<b>Hydrograph Reports.....</b>	<b>27</b>
Hydrograph No. 1, SBUH Runoff, Pre-Dev-A.....	27
Hydrograph No. 2, SCS Runoff, Post-Dev-A.....	28
Hydrograph No. 3, Reservoir, A thru DP-A.....	29
Hydrograph No. 4, SBUH Runoff, Pre Dev-B.....	30
Hydrograph No. 5, SCS Runoff, Post-Dev-B.....	31
Hydrograph No. 6, Reservoir, B thru DP-B.....	32
<b>100 - Year</b>	
<b>Summary Report.....</b>	<b>33</b>

---

<b>Hydrograph Reports</b> .....	<b>34</b>
Hydrograph No. 1, SBUH Runoff, Pre-Dev-A.....	34
Hydrograph No. 2, SCS Runoff, Post-Dev-A.....	35
Hydrograph No. 3, Reservoir, A thru DP-A.....	36
Hydrograph No. 4, SBUH Runoff, Pre Dev-B.....	37
Hydrograph No. 5, SCS Runoff, Post-Dev-B.....	38
Hydrograph No. 6, Reservoir, B thru DP-B.....	39

# Watershed Model Schematic

Hydraflow Hydrographs Extension for Autodesk® Civil 3D® by Autodesk, Inc. v2022

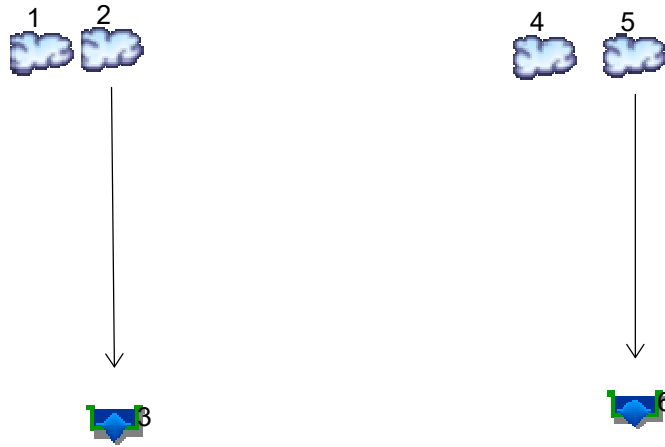

## Legend

<u>Hyd. Origin</u>	<u>Description</u>
1	SBUH Runoff Pre-Dev-A
2	SCS Runoff Post-Dev-A
3	Reservoir A thru DP-A
4	SBUH Runoff Pre Dev-B
5	SCS Runoff Post-Dev-B
6	Reservoir B thru DP-B

# Hydrograph Return Period Recap

Hydraflow Hydrographs Extension for Autodesk® Civil 3D® by Autodesk, Inc. v2022

Hyd. No.	Hydrograph type (origin)	Inflow hyd(s)	Peak Outflow (cfs)								Hydrograph Description
			1-yr	2-yr	3-yr	5-yr	10-yr	25-yr	50-yr	100-yr	
1	SBUH Runoff	-----	-----	0.334	-----	-----	0.681	0.861	1.007	1.114	Pre-Dev-A
2	SCS Runoff	-----	-----	0.801	-----	-----	1.298	1.537	1.725	1.859	Post-Dev-A
3	Reservoir	2	-----	0.579	-----	-----	0.785	0.871	0.937	0.983	A thru DP-A
4	SBUH Runoff	-----	-----	0.341	-----	-----	0.695	0.879	1.029	1.137	Pre Dev-B
5	SCS Runoff	-----	-----	0.496	-----	-----	0.831	0.996	1.125	1.217	Post-Dev-B
6	Reservoir	5	-----	0.341	-----	-----	0.514	0.590	0.642	0.677	B thru DP-B

# Hydrograph Summary Report

Hydraflow Hydrographs Extension for Autodesk® Civil 3D® by Autodesk, Inc. v2022

Hyd. No.	Hydrograph type (origin)	Peak flow (cfs)	Time interval (min)	Time to Peak (min)	Hyd. volume (cuft)	Inflow hyd(s)	Maximum elevation (ft)	Total strge used (cuft)	Hydrograph Description
1	SBUH Runoff	0.334	2	480	6,066	-----	-----	-----	Pre-Dev-A
2	SCS Runoff	0.801	2	474	11,552	-----	-----	-----	Post-Dev-A
3	Reservoir	0.579	2	486	10,754	2	214.87	1,687	A thru DP-A
4	SBUH Runoff	0.341	2	480	6,195	-----	-----	-----	Pre Dev-B
5	SCS Runoff	0.496	2	476	7,334	-----	-----	-----	Post-Dev-B
6	Reservoir	0.341	2	486	7,327	5	216.49	745	B thru DP-B
20230727-PGE-memorial-DP-A-&-B.gpw					Return Period: 2 Year			Tuesday, 10 / 24 / 2023	

# Hydrograph Report

Hydraflow Hydrographs Extension for Autodesk® Civil 3D® by Autodesk, Inc. v2022

Tuesday, 10 / 24 / 2023

## Hyd. No. 1

Pre-Dev-A

Hydrograph type	= SBUH Runoff	Peak discharge	= 0.334 cfs
Storm frequency	= 2 yrs	Time to peak	= 480 min
Time interval	= 2 min	Hyd. volume	= 6,066 cuft
Drainage area	= 1.880 ac	Curve number	= 80
Basin Slope	= 0.0 %	Hydraulic length	= 0 ft
Tc method	= User	Time of conc. (Tc)	= 5.00 min
Total precip.	= 2.50 in	Distribution	= Type IA
Storm duration	= 24 hrs	Shape factor	= n/a

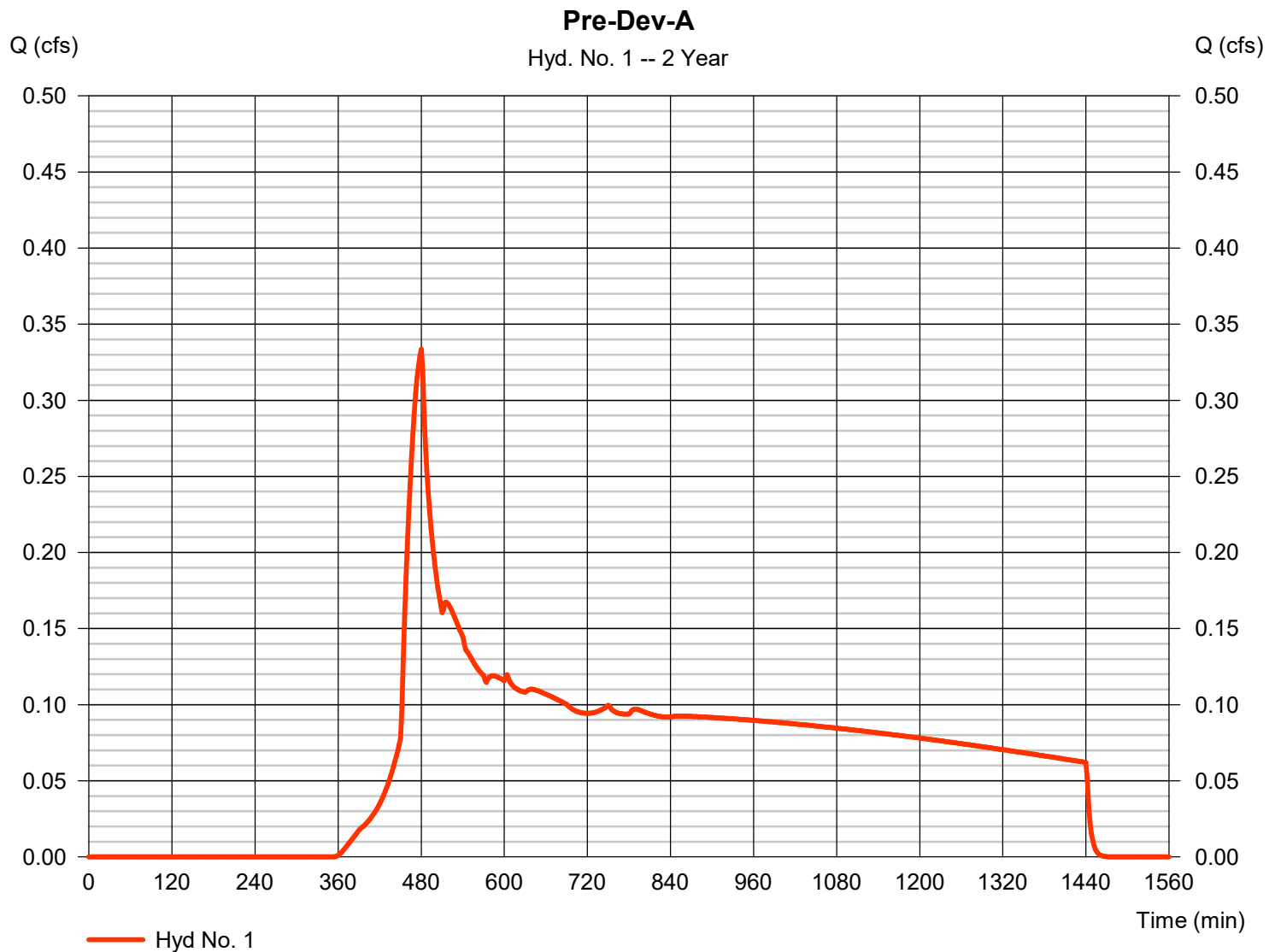

# Hydrograph Report

Hydraflow Hydrographs Extension for Autodesk® Civil 3D® by Autodesk, Inc. v2022

Tuesday, 10 / 24 / 2023

## Hyd. No. 2

Post-Dev-A

Hydrograph type	= SCS Runoff	Peak discharge	= 0.801 cfs
Storm frequency	= 2 yrs	Time to peak	= 474 min
Time interval	= 2 min	Hyd. volume	= 11,552 cuft
Drainage area	= 2.240 ac	Curve number	= 89.8
Basin Slope	= 0.0 %	Hydraulic length	= 0 ft
Tc method	= User	Time of conc. (Tc)	= 5.00 min
Total precip.	= 2.50 in	Distribution	= Type IA
Storm duration	= 24 hrs	Shape factor	= 484

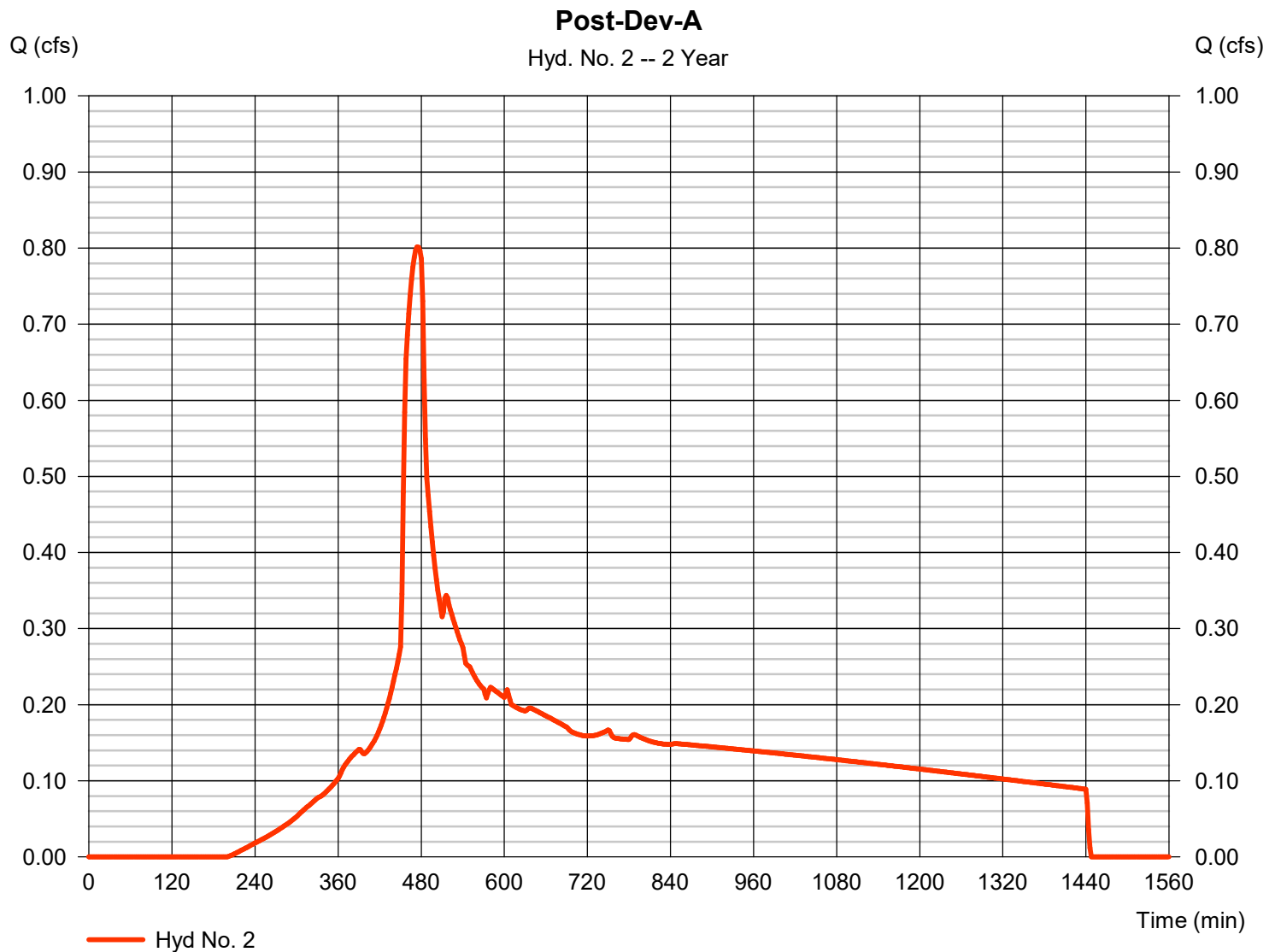

# Hydrograph Report

Hydraflow Hydrographs Extension for Autodesk® Civil 3D® by Autodesk, Inc. v2022

Tuesday, 10 / 24 / 2023

## Hyd. No. 3

A thru DP-A

Hydrograph type	= Reservoir	Peak discharge	= 0.579 cfs
Storm frequency	= 2 yrs	Time to peak	= 486 min
Time interval	= 2 min	Hyd. volume	= 10,754 cuft
Inflow hyd. No.	= 2 - Post-Dev-A	Max. Elevation	= 214.87 ft
Reservoir name	= DP-A	Max. Storage	= 1,687 cuft

Storage Indication method used.

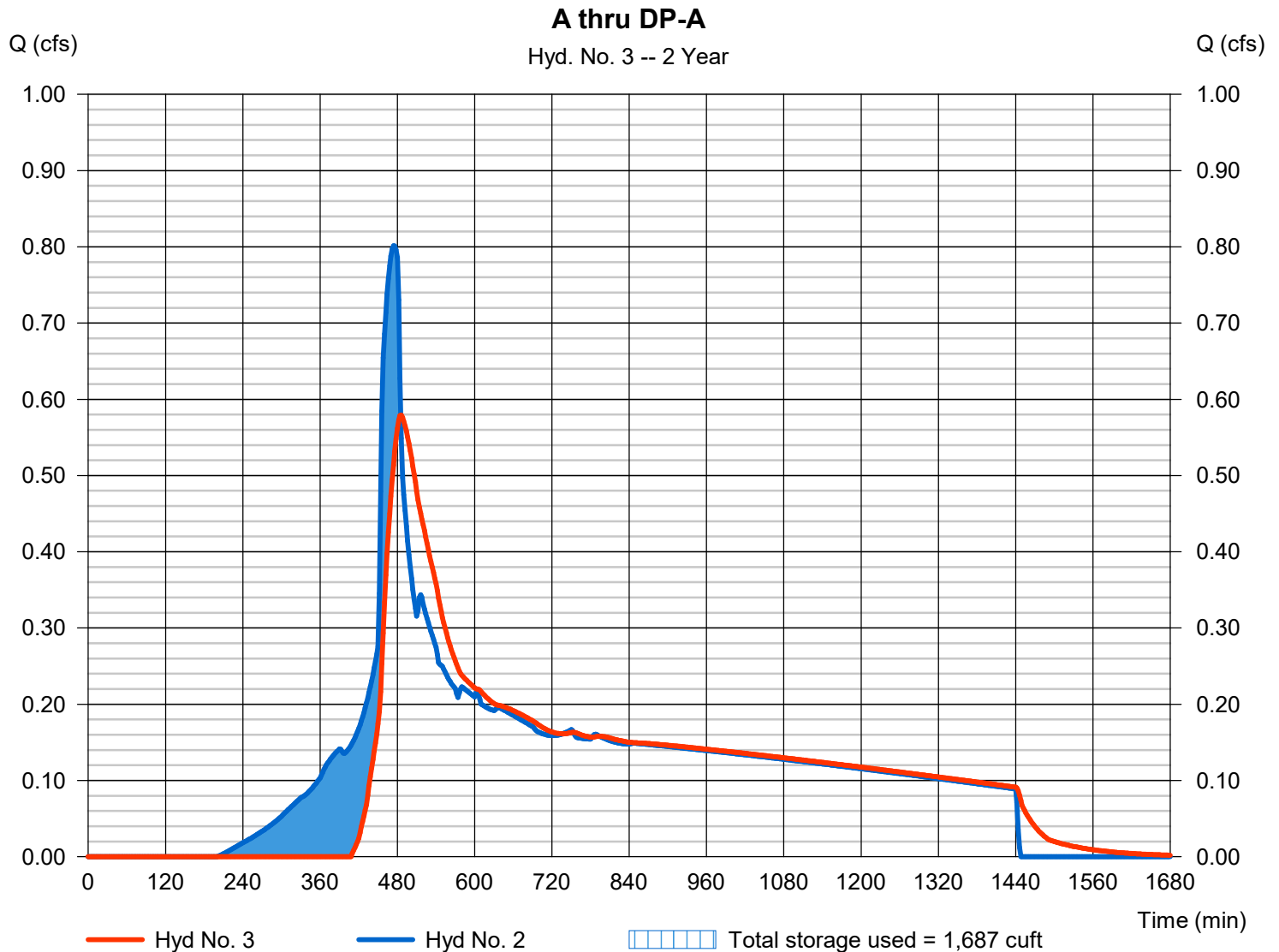



# Pond Report

Hydraflow Hydrographs Extension for Autodesk® Civil 3D® by Autodesk, Inc. v2022

Tuesday, 10 / 24 / 2023

## Pond No. 2 - DP-A

### Pond Data

Pond storage is based on user-defined values.

### Stage / Storage Table

Stage (ft)	Elevation (ft)	Contour area (sqft)	Incr. Storage (cuft)	Total storage (cuft)
0.00	211.50	n/a	0	0
1.50	213.00	n/a	48	48
3.00	214.50	n/a	668	716
4.00	215.50	n/a	922	1,638
5.00	216.50	n/a	1,456	3,094
6.00	217.50	n/a	2,062	5,156
6.50	218.00	n/a	1,275	6,431

### Culvert / Orifice Structures

	[A]	[B]	[C]	[PrfRsr]
Rise (in)	= 12.00	2.20	4.50	0.00
Span (in)	= 12.00	2.20	4.50	0.00
No. Barrels	= 1	1	1	0
Invert El. (ft)	= 211.50	211.50	214.90	0.00
Length (ft)	= 0.00	0.00	0.00	0.00
Slope (%)	= 0.00	0.00	0.00	n/a
N-Value	= .013	.013	.013	n/a
Orifice Coeff.	= 0.60	0.60	0.60	0.60
Multi-Stage	= n/a	Yes	No	No

### Weir Structures

	[A]	[B]	[C]	[D]
Crest Len (ft)	= 3.14	0.00	0.00	0.00
Crest El. (ft)	= 217.50	0.00	0.00	0.00
Weir Coeff.	= 3.33	3.33	3.33	3.33
Weir Type	= 1	---	---	---
Multi-Stage	= Yes	No	No	No
Exfil.(in/hr)	= 0.000 (by Wet area)			
TW Elev. (ft)	= 0.00			

Note: Culvert/Orifice outflows are analyzed under inlet (ic) and outlet (oc) control. Weir risers checked for orifice conditions (ic) and submergence (s).

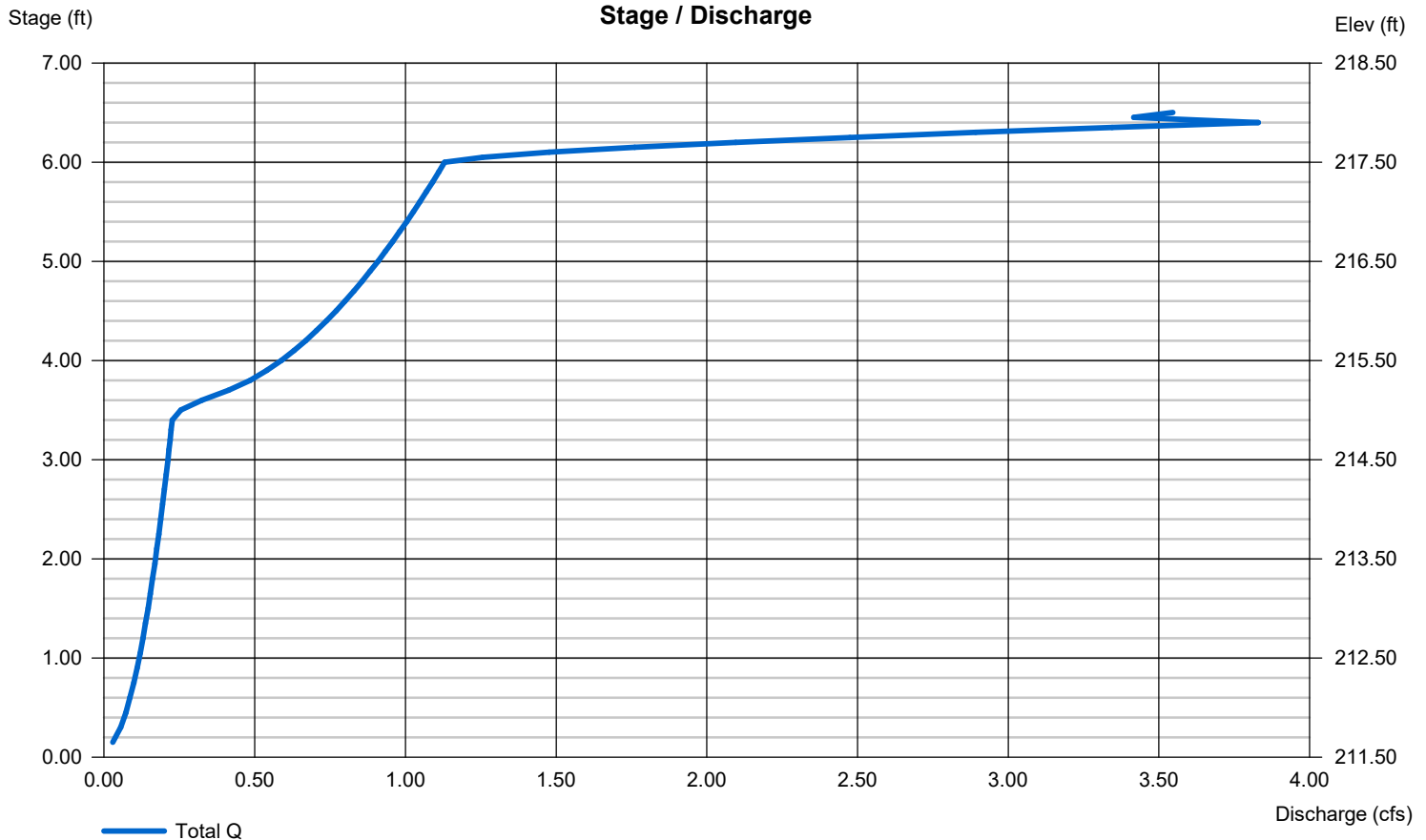

# Hydrograph Report

Hydraflow Hydrographs Extension for Autodesk® Civil 3D® by Autodesk, Inc. v2022

Tuesday, 10 / 24 / 2023

## Hyd. No. 4

Pre Dev-B

Hydrograph type	= SBUH Runoff	Peak discharge	= 0.341 cfs
Storm frequency	= 2 yrs	Time to peak	= 480 min
Time interval	= 2 min	Hyd. volume	= 6,195 cuft
Drainage area	= 1.920 ac	Curve number	= 80
Basin Slope	= 0.0 %	Hydraulic length	= 0 ft
Tc method	= User	Time of conc. (Tc)	= 5.00 min
Total precip.	= 2.50 in	Distribution	= Type IA
Storm duration	= 24 hrs	Shape factor	= n/a

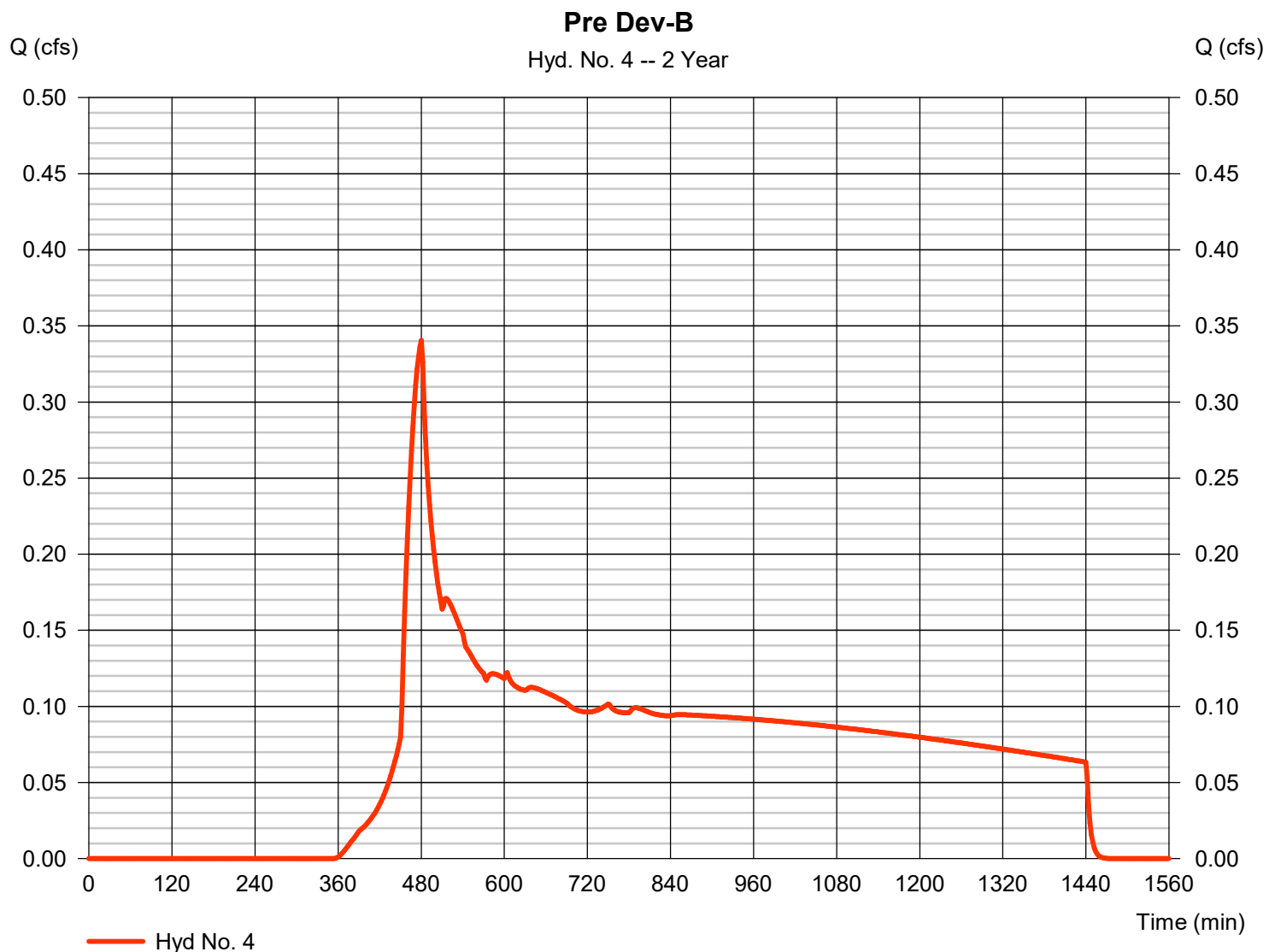

# Hydrograph Report

Hydraflow Hydrographs Extension for Autodesk® Civil 3D® by Autodesk, Inc. v2022

Tuesday, 10 / 24 / 2023

## Hyd. No. 5

Post-Dev-B

Hydrograph type	= SCS Runoff	Peak discharge	= 0.496 cfs
Storm frequency	= 2 yrs	Time to peak	= 476 min
Time interval	= 2 min	Hyd. volume	= 7,334 cuft
Drainage area	= 1.560 ac	Curve number	= 88
Basin Slope	= 0.0 %	Hydraulic length	= 0 ft
Tc method	= User	Time of conc. (Tc)	= 5.00 min
Total precip.	= 2.50 in	Distribution	= Type IA
Storm duration	= 24 hrs	Shape factor	= 484

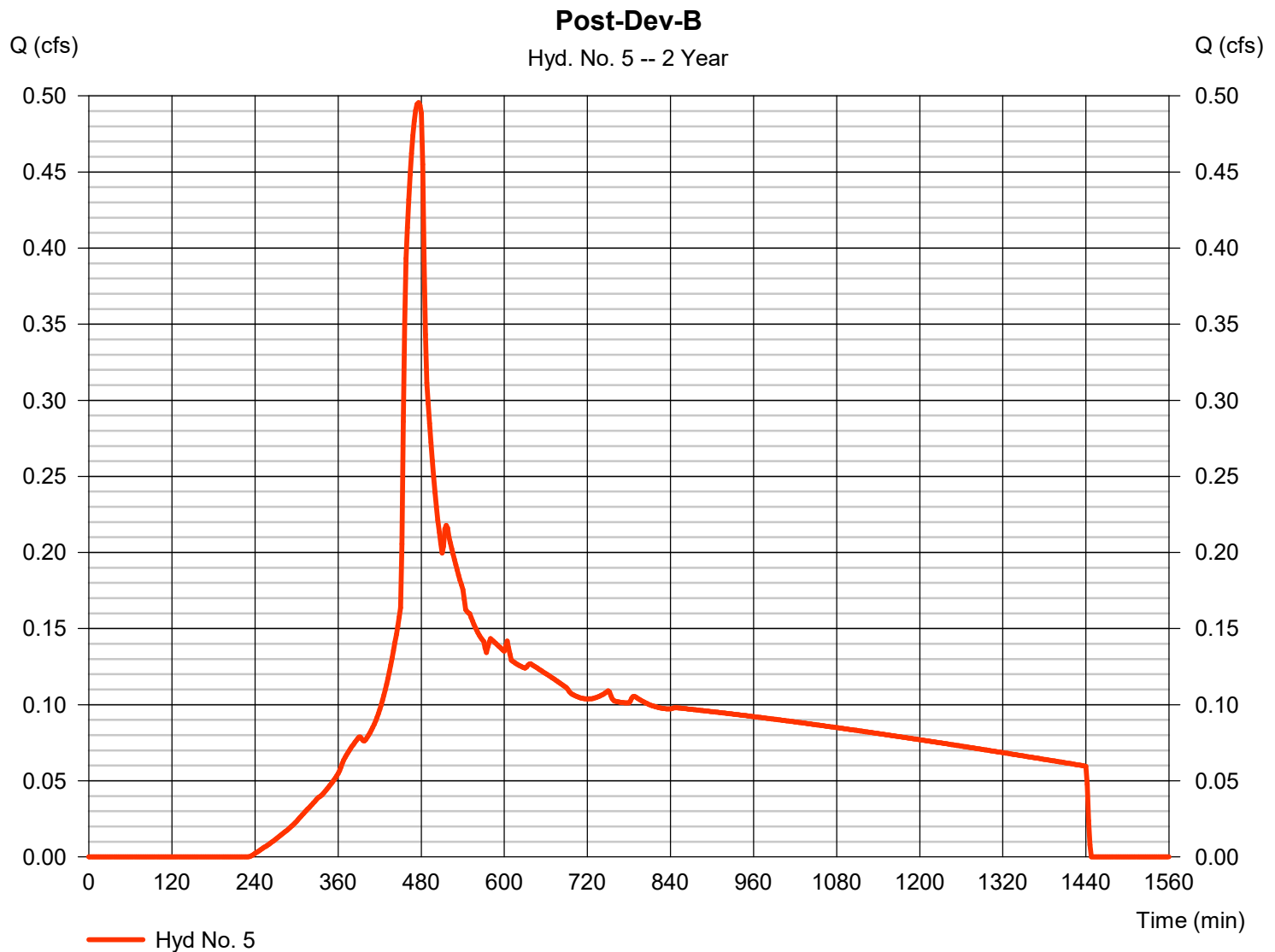

# Hydrograph Report

Hydraflow Hydrographs Extension for Autodesk® Civil 3D® by Autodesk, Inc. v2022

Tuesday, 10 / 24 / 2023

## Hyd. No. 6

B thru DP-B

Hydrograph type	= Reservoir	Peak discharge	= 0.341 cfs
Storm frequency	= 2 yrs	Time to peak	= 486 min
Time interval	= 2 min	Hyd. volume	= 7,327 cuft
Inflow hyd. No.	= 5 - Post-Dev-B	Max. Elevation	= 216.49 ft
Reservoir name	= DP-B	Max. Storage	= 745 cuft

Storage Indication method used.

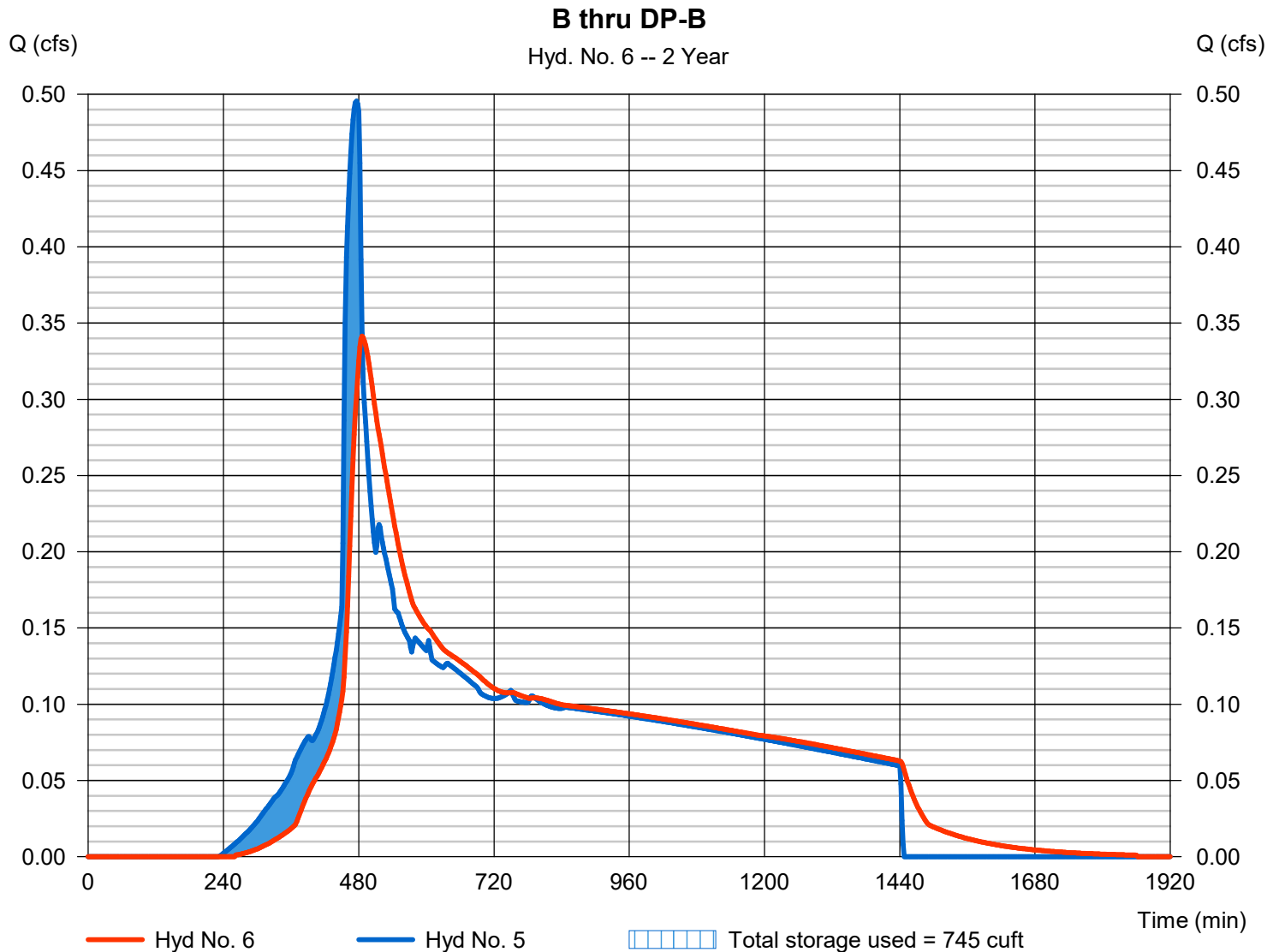

# Pond Report

Hydraflow Hydrographs Extension for Autodesk® Civil 3D® by Autodesk, Inc. v2022

Tuesday, 10 / 24 / 2023

## Pond No. 3 - DP-B

### Pond Data

Pond storage is based on user-defined values.

### Stage / Storage Table

Stage (ft)	Elevation (ft)	Contour area (sqft)	Incr. Storage (cuft)	Total storage (cuft)
0.00	213.00	n/a	0	0
1.50	214.50	n/a	37	37
3.00	216.00	n/a	156	193
4.00	217.00	n/a	712	904
5.00	218.00	n/a	1,095	1,999
6.00	219.00	n/a	1,533	3,533

### Culvert / Orifice Structures

	[A]	[B]	[C]	[PrfRsr]
Rise (in)	= 12.00	1.80	3.80	0.00
Span (in)	= 12.00	1.80	5.25	0.00
No. Barrels	= 1	1	1	0
Invert El. (ft)	= 213.00	213.00	216.33	0.00
Length (ft)	= 30.00	0.00	0.00	0.00
Slope (%)	= 2.00	0.00	0.00	n/a
N-Value	= .013	.013	.013	n/a
Orifice Coeff.	= 0.60	0.60	0.60	0.60
Multi-Stage	= n/a	Yes	Yes	No

### Weir Structures

	[A]	[B]	[C]	[D]
Crest Len (ft)	= 3.14	0.00	0.00	0.00
Crest El. (ft)	= 218.50	0.00	0.00	0.00
Weir Coeff.	= 3.33	3.33	3.33	3.33
Weir Type	= 1	---	---	---
Multi-Stage	= Yes	No	No	No
Exfil. (in/hr)	= 0.000 (by Wet area)			
TW Elev. (ft)	= 0.00			

Note: Culvert/Orifice outflows are analyzed under inlet (ic) and outlet (oc) control. Weir risers checked for orifice conditions (ic) and submergence (s).

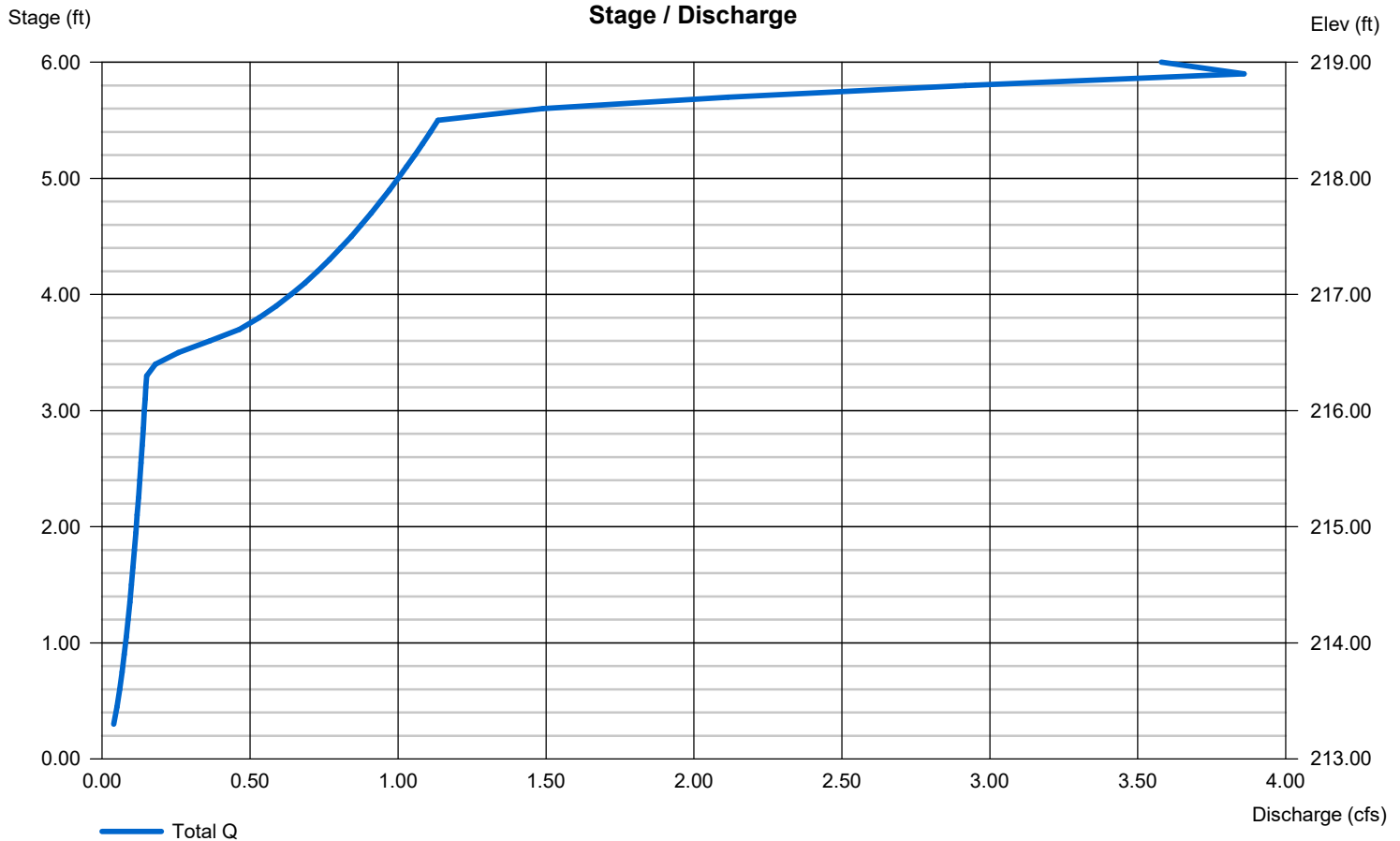

# Hydrograph Summary Report

Hydraflow Hydrographs Extension for Autodesk® Civil 3D® by Autodesk, Inc. v2022

Hyd. No.	Hydrograph type (origin)	Peak flow (cfs)	Time interval (min)	Time to Peak (min)	Hyd. volume (cuft)	Inflow hyd(s)	Maximum elevation (ft)	Total strge used (cuft)	Hydrograph Description
1	SBUH Runoff	0.681	2	480	10,897	-----	-----	-----	Pre-Dev-A
2	SCS Runoff	1.298	2	474	18,165	-----	-----	-----	Post-Dev-A
3	Reservoir	0.785	2	488	17,367	2	215.36	2,407	A thru DP-A
4	SBUH Runoff	0.695	2	480	11,129	-----	-----	-----	Pre Dev-B
5	SCS Runoff	0.831	2	474	11,802	-----	-----	-----	Post-Dev-B
6	Reservoir	0.514	2	488	11,795	5	216.81	1,235	B thru DP-B
20230727-PGE-memorial-DP-A-&-B.gpw					Return Period: 10 Year			Tuesday, 10 / 24 / 2023	

# Hydrograph Report

Hydraflow Hydrographs Extension for Autodesk® Civil 3D® by Autodesk, Inc. v2022

Tuesday, 10 / 24 / 2023

## Hyd. No. 1

Pre-Dev-A

Hydrograph type	= SBUH Runoff	Peak discharge	= 0.681 cfs
Storm frequency	= 10 yrs	Time to peak	= 480 min
Time interval	= 2 min	Hyd. volume	= 10,897 cuft
Drainage area	= 1.880 ac	Curve number	= 80
Basin Slope	= 0.0 %	Hydraulic length	= 0 ft
Tc method	= User	Time of conc. (Tc)	= 5.00 min
Total precip.	= 3.45 in	Distribution	= Type IA
Storm duration	= 24 hrs	Shape factor	= n/a

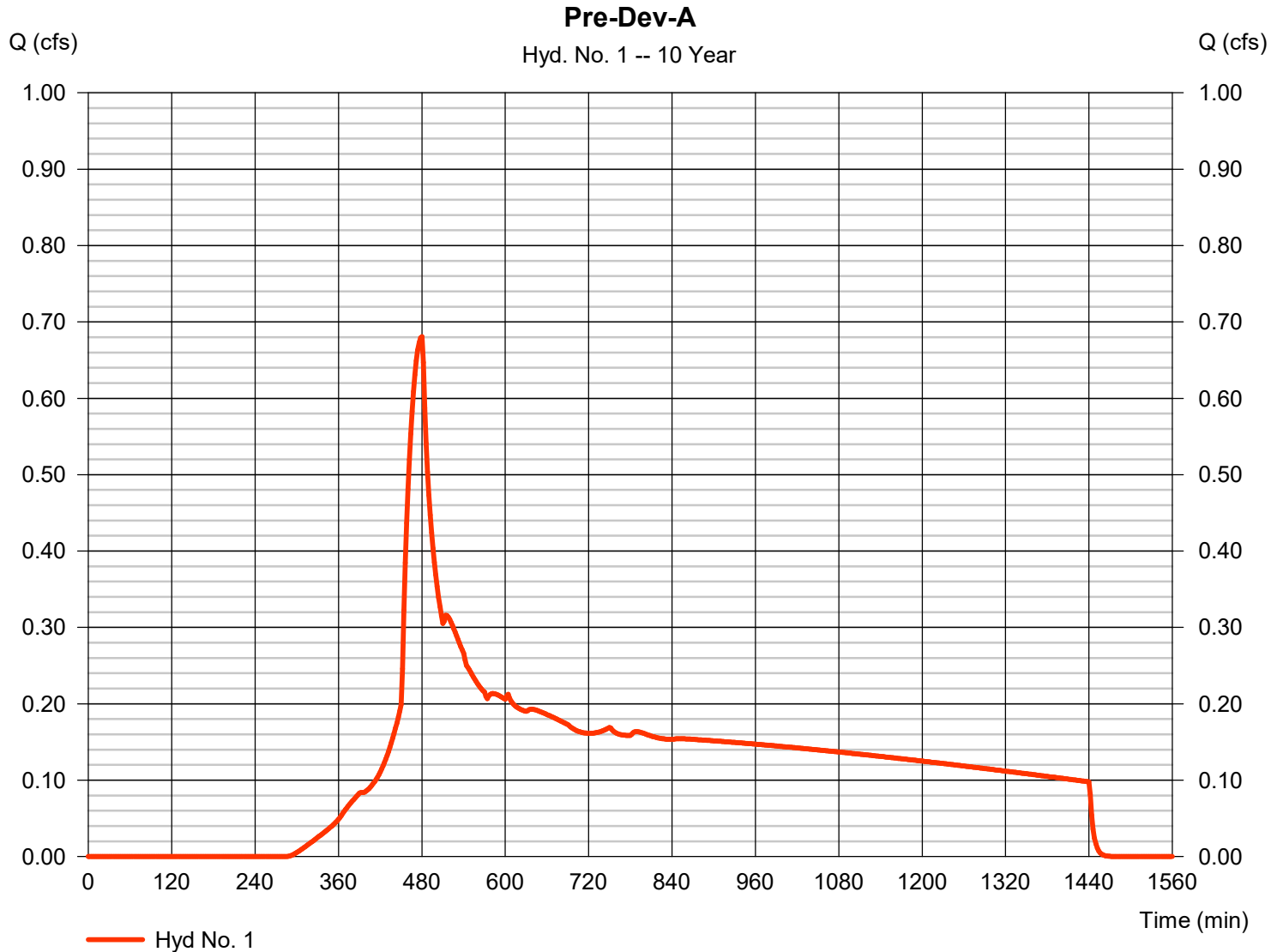

# Hydrograph Report

Hydraflow Hydrographs Extension for Autodesk® Civil 3D® by Autodesk, Inc. v2022

Tuesday, 10 / 24 / 2023

## Hyd. No. 2

Post-Dev-A

Hydrograph type	= SCS Runoff	Peak discharge	= 1.298 cfs
Storm frequency	= 10 yrs	Time to peak	= 474 min
Time interval	= 2 min	Hyd. volume	= 18,165 cuft
Drainage area	= 2.240 ac	Curve number	= 89.8
Basin Slope	= 0.0 %	Hydraulic length	= 0 ft
Tc method	= User	Time of conc. (Tc)	= 5.00 min
Total precip.	= 3.45 in	Distribution	= Type IA
Storm duration	= 24 hrs	Shape factor	= 484

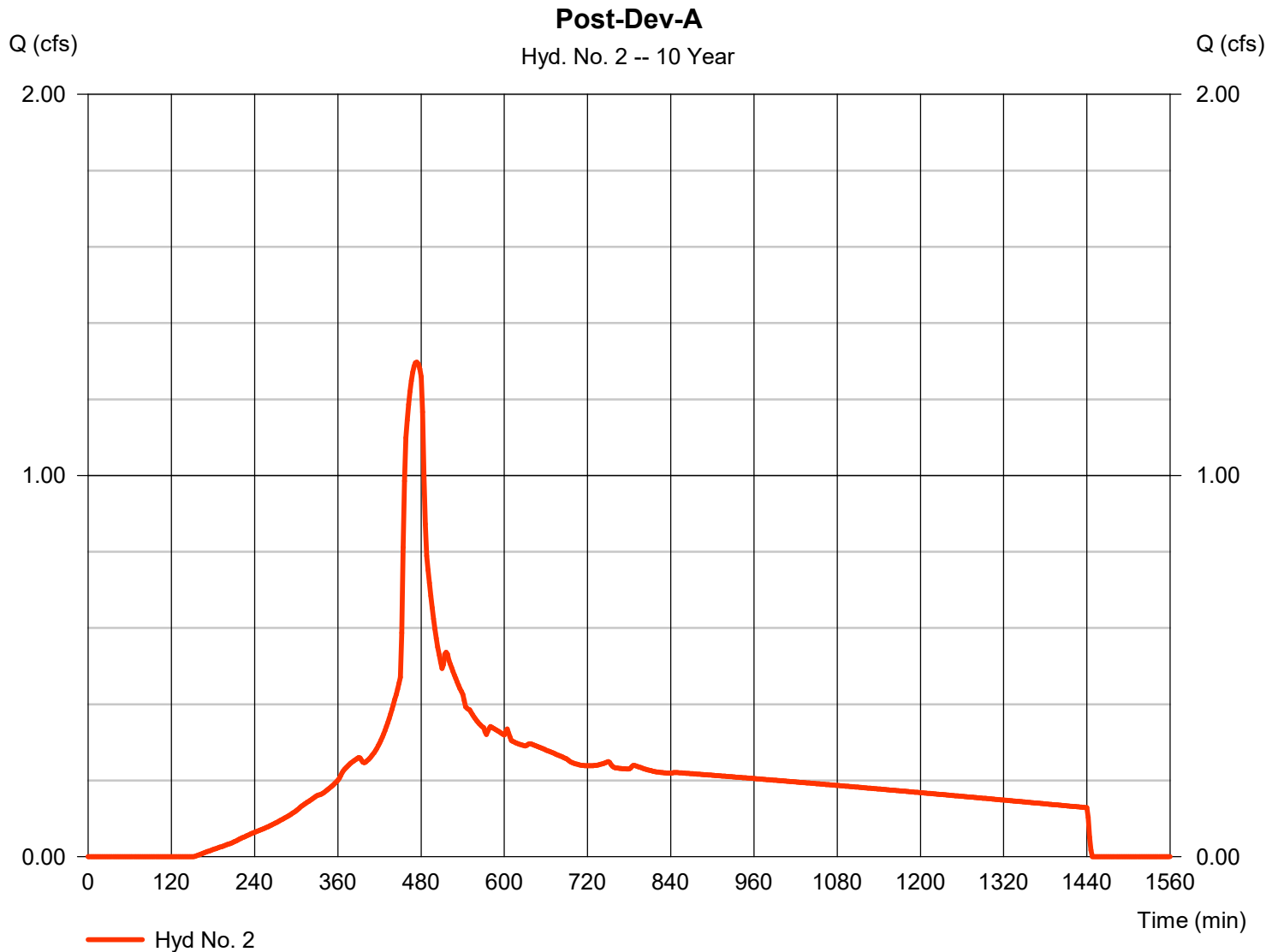



# Hydrograph Report

Hydraflow Hydrographs Extension for Autodesk® Civil 3D® by Autodesk, Inc. v2022

Tuesday, 10 / 24 / 2023

## Hyd. No. 3

A thru DP-A

Hydrograph type	= Reservoir	Peak discharge	= 0.785 cfs
Storm frequency	= 10 yrs	Time to peak	= 488 min
Time interval	= 2 min	Hyd. volume	= 17,367 cuft
Inflow hyd. No.	= 2 - Post-Dev-A	Max. Elevation	= 215.36 ft
Reservoir name	= DP-A	Max. Storage	= 2,407 cuft

Storage Indication method used.

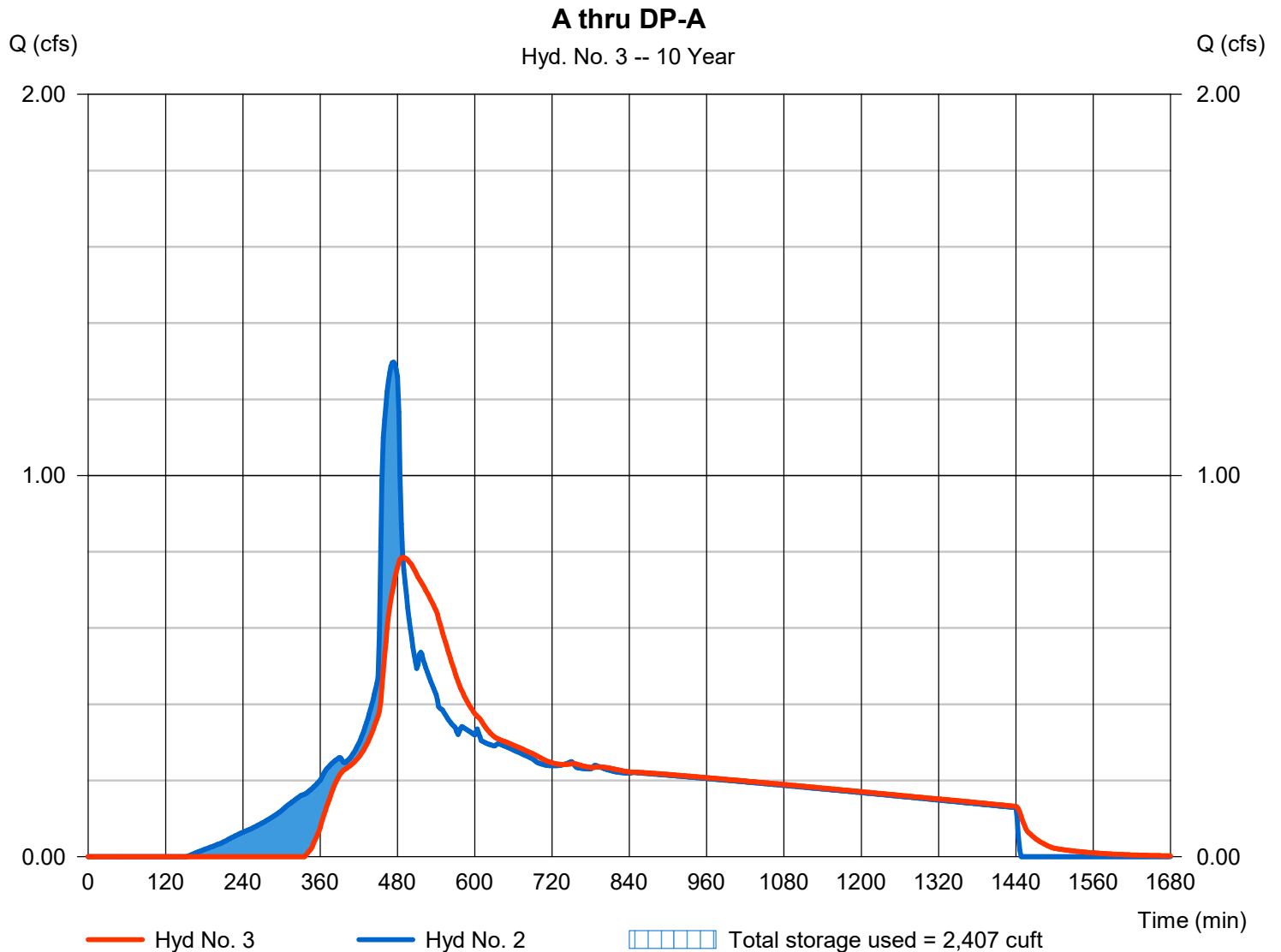

# Hydrograph Report

Hydraflow Hydrographs Extension for Autodesk® Civil 3D® by Autodesk, Inc. v2022

Tuesday, 10 / 24 / 2023

## Hyd. No. 4

Pre Dev-B

Hydrograph type	= SBUH Runoff	Peak discharge	= 0.695 cfs
Storm frequency	= 10 yrs	Time to peak	= 480 min
Time interval	= 2 min	Hyd. volume	= 11,129 cuft
Drainage area	= 1.920 ac	Curve number	= 80
Basin Slope	= 0.0 %	Hydraulic length	= 0 ft
Tc method	= User	Time of conc. (Tc)	= 5.00 min
Total precip.	= 3.45 in	Distribution	= Type IA
Storm duration	= 24 hrs	Shape factor	= n/a

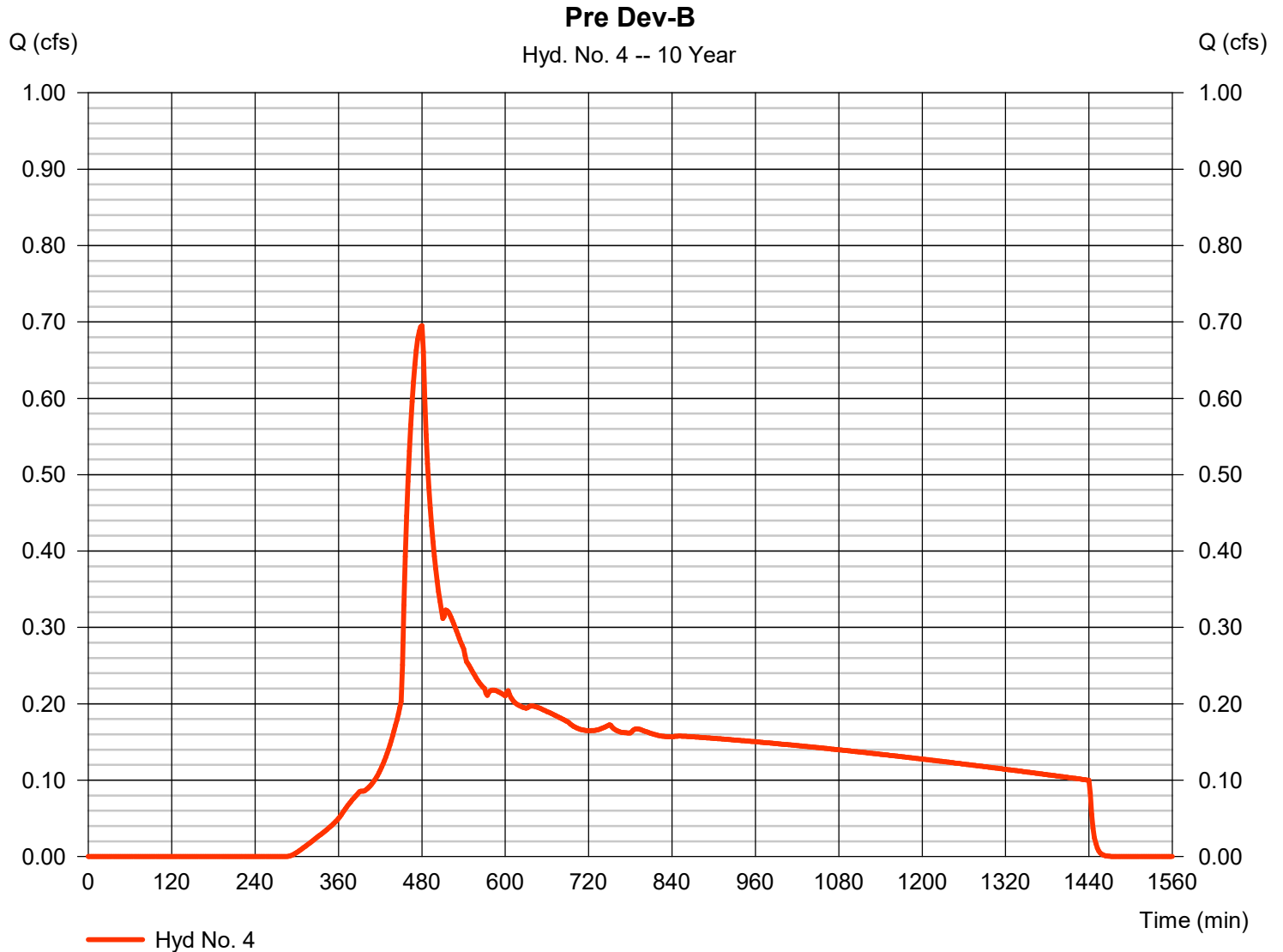

# Hydrograph Report

Hydraflow Hydrographs Extension for Autodesk® Civil 3D® by Autodesk, Inc. v2022

Tuesday, 10 / 24 / 2023

## Hyd. No. 5

Post-Dev-B

Hydrograph type	= SCS Runoff	Peak discharge	= 0.831 cfs
Storm frequency	= 10 yrs	Time to peak	= 474 min
Time interval	= 2 min	Hyd. volume	= 11,802 cuft
Drainage area	= 1.560 ac	Curve number	= 88
Basin Slope	= 0.0 %	Hydraulic length	= 0 ft
Tc method	= User	Time of conc. (Tc)	= 5.00 min
Total precip.	= 3.45 in	Distribution	= Type IA
Storm duration	= 24 hrs	Shape factor	= 484

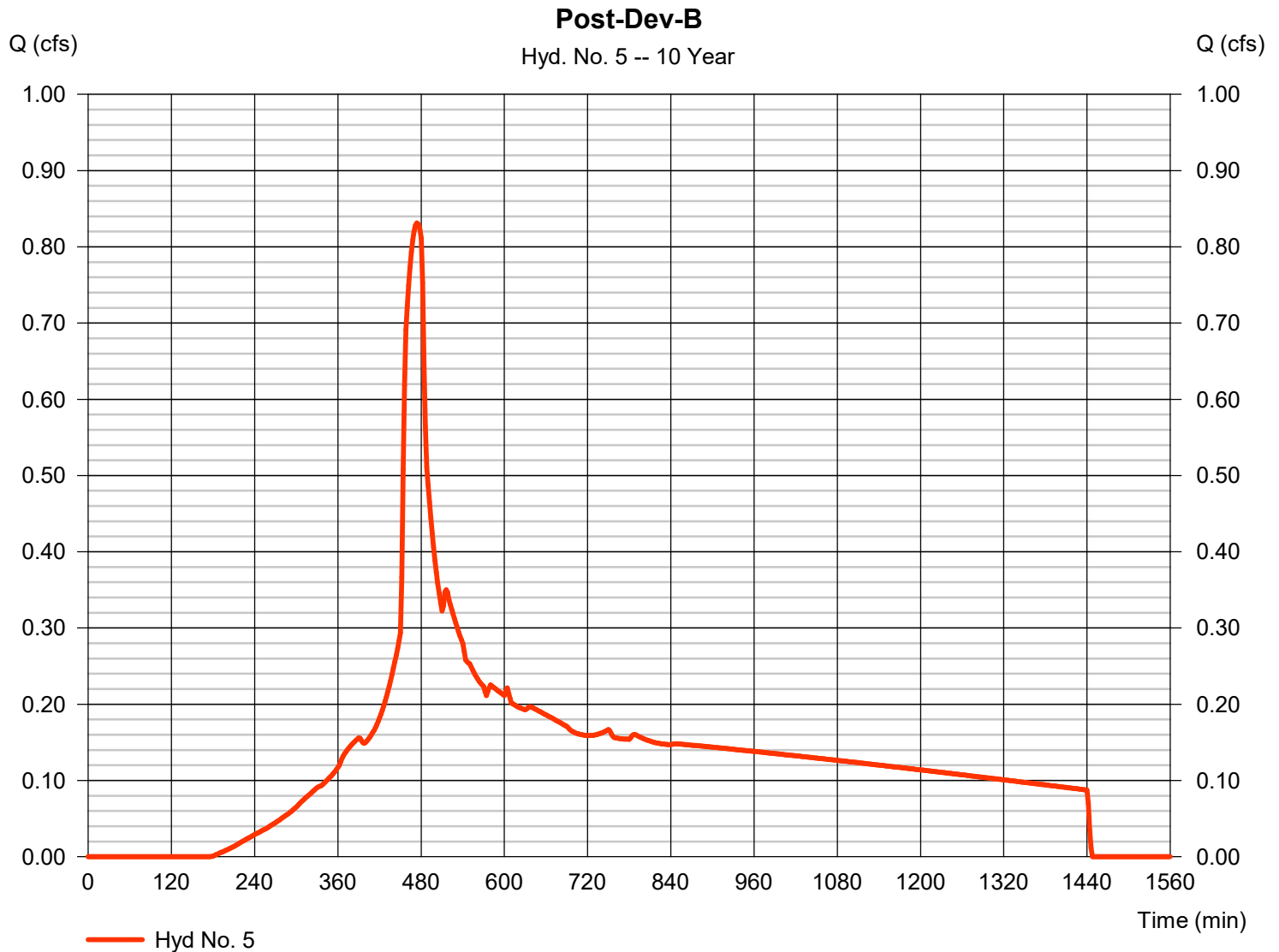

# Hydrograph Report

Hydraflow Hydrographs Extension for Autodesk® Civil 3D® by Autodesk, Inc. v2022

Tuesday, 10 / 24 / 2023

## Hyd. No. 6

B thru DP-B

Hydrograph type	= Reservoir	Peak discharge	= 0.514 cfs
Storm frequency	= 10 yrs	Time to peak	= 488 min
Time interval	= 2 min	Hyd. volume	= 11,795 cuft
Inflow hyd. No.	= 5 - Post-Dev-B	Max. Elevation	= 216.81 ft
Reservoir name	= DP-B	Max. Storage	= 1,235 cuft

Storage Indication method used.

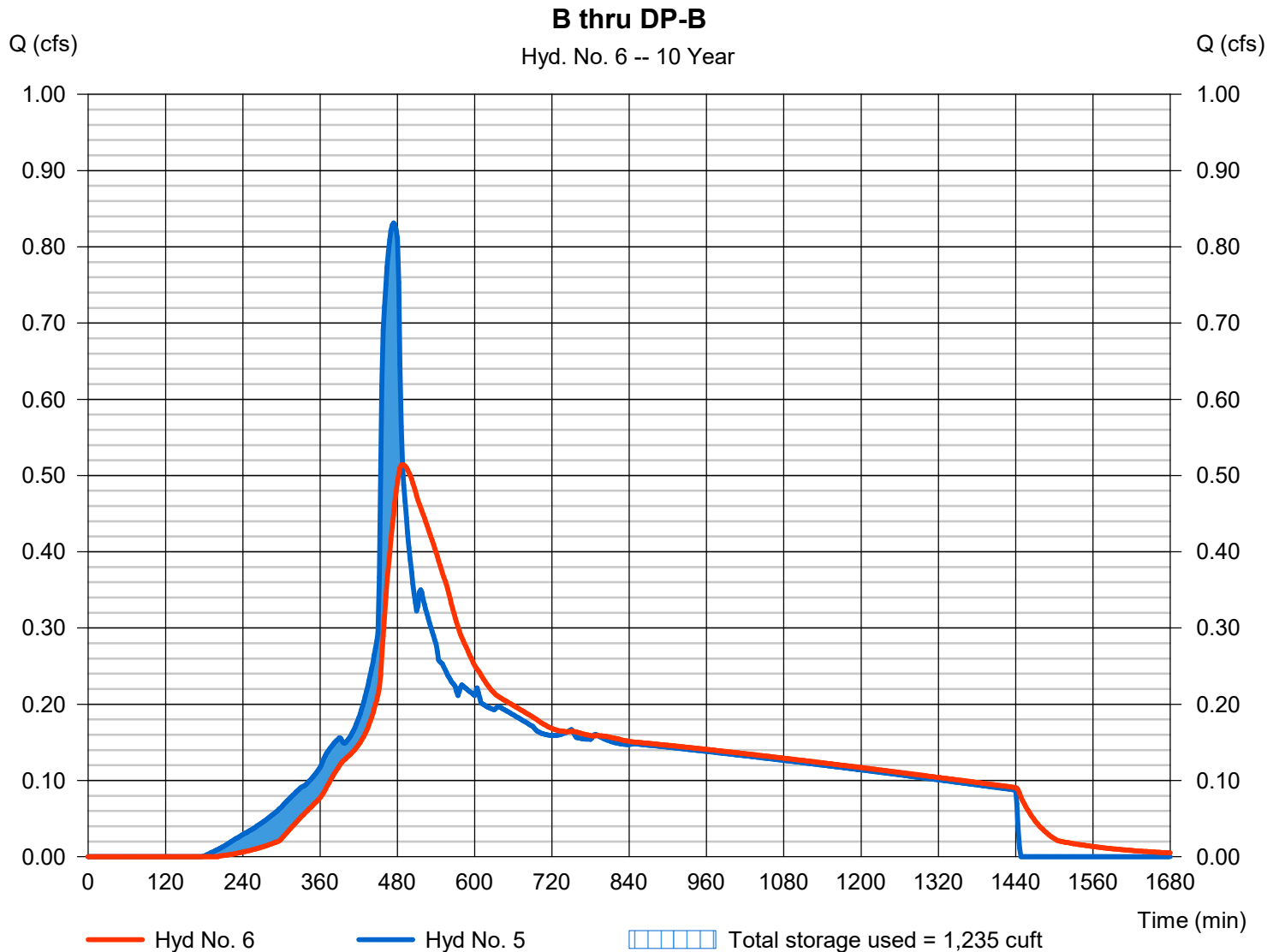

# Hydrograph Summary Report

Hydraflow Hydrographs Extension for Autodesk® Civil 3D® by Autodesk, Inc. v2022

Hyd. No.	Hydrograph type (origin)	Peak flow (cfs)	Time interval (min)	Time to Peak (min)	Hyd. volume (cuft)	Inflow hyd(s)	Maximum elevation (ft)	Total strge used (cuft)	Hydrograph Description
1	SBUH Runoff	0.861	2	478	13,371	-----	-----	-----	Pre-Dev-A
2	SCS Runoff	1.537	2	474	21,385	-----	-----	-----	Post-Dev-A
3	Reservoir	0.871	2	490	20,587	2	215.61	2,813	A thru DP-A
4	SBUH Runoff	0.879	2	478	13,656	-----	-----	-----	Pre Dev-B
5	SCS Runoff	0.996	2	474	13,995	-----	-----	-----	Post-Dev-B
6	Reservoir	0.590	2	490	13,988	5	216.98	1,496	B thru DP-B
20230727-PGE-memorial-DP-A-&-B.gpw					Return Period: 25 Year			Tuesday, 10 / 24 / 2023	

# Hydrograph Report

Hydraflow Hydrographs Extension for Autodesk® Civil 3D® by Autodesk, Inc. v2022

Tuesday, 10 / 24 / 2023

## Hyd. No. 1

Pre-Dev-A

Hydrograph type	= SBUH Runoff	Peak discharge	= 0.861 cfs
Storm frequency	= 25 yrs	Time to peak	= 478 min
Time interval	= 2 min	Hyd. volume	= 13,371 cuft
Drainage area	= 1.880 ac	Curve number	= 80
Basin Slope	= 0.0 %	Hydraulic length	= 0 ft
Tc method	= User	Time of conc. (Tc)	= 5.00 min
Total precip.	= 3.90 in	Distribution	= Type IA
Storm duration	= 24 hrs	Shape factor	= n/a

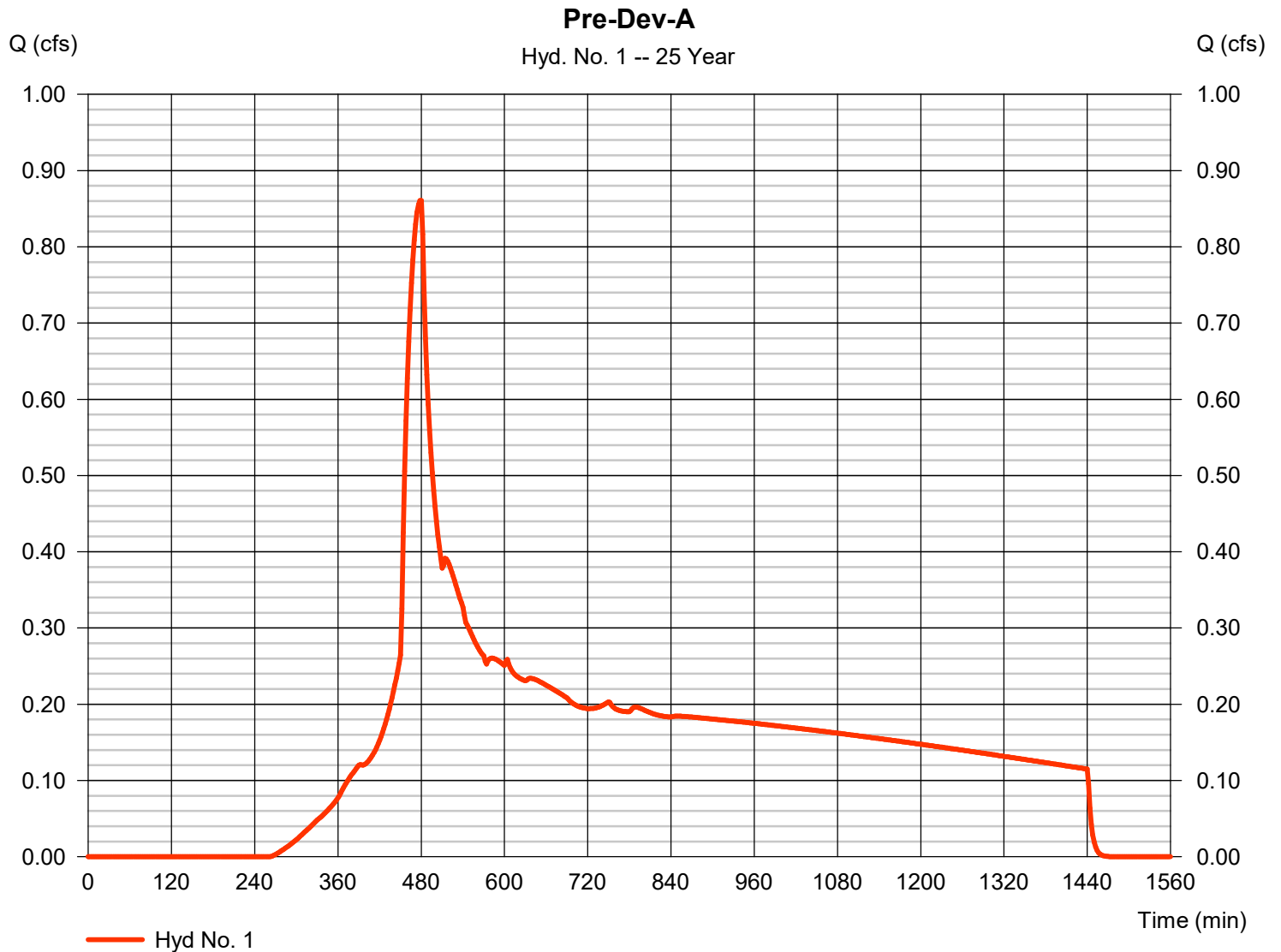

# Hydrograph Report

Hydraflow Hydrographs Extension for Autodesk® Civil 3D® by Autodesk, Inc. v2022

Tuesday, 10 / 24 / 2023

## Hyd. No. 2

Post-Dev-A

Hydrograph type	= SCS Runoff	Peak discharge	= 1.537 cfs
Storm frequency	= 25 yrs	Time to peak	= 474 min
Time interval	= 2 min	Hyd. volume	= 21,385 cuft
Drainage area	= 2.240 ac	Curve number	= 89.8
Basin Slope	= 0.0 %	Hydraulic length	= 0 ft
Tc method	= User	Time of conc. (Tc)	= 5.00 min
Total precip.	= 3.90 in	Distribution	= Type IA
Storm duration	= 24 hrs	Shape factor	= 484

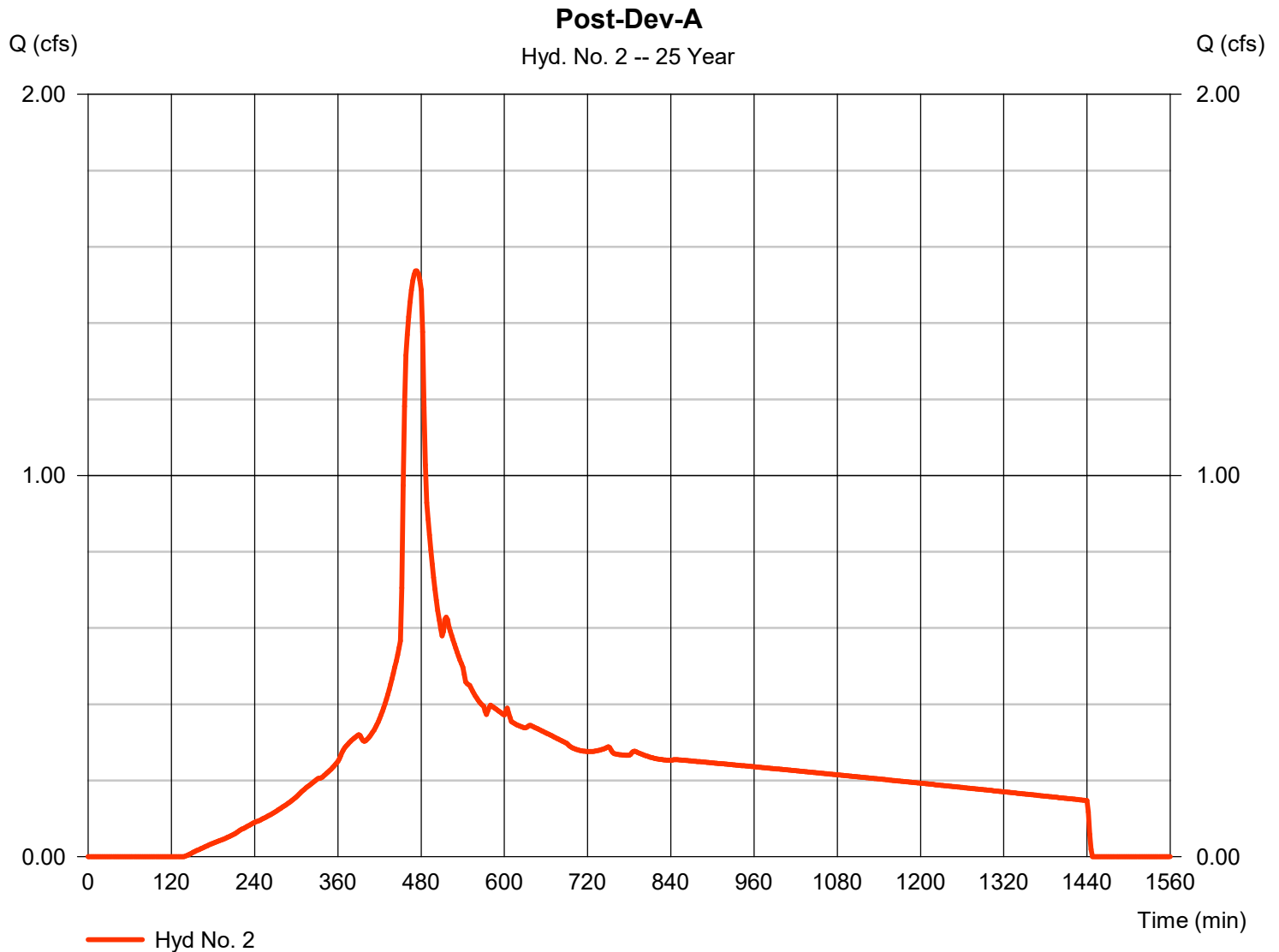



# Hydrograph Report

Hydraflow Hydrographs Extension for Autodesk® Civil 3D® by Autodesk, Inc. v2022

Tuesday, 10 / 24 / 2023

## Hyd. No. 3

A thru DP-A

Hydrograph type	= Reservoir	Peak discharge	= 0.871 cfs
Storm frequency	= 25 yrs	Time to peak	= 490 min
Time interval	= 2 min	Hyd. volume	= 20,587 cuft
Inflow hyd. No.	= 2 - Post-Dev-A	Max. Elevation	= 215.61 ft
Reservoir name	= DP-A	Max. Storage	= 2,813 cuft

Storage Indication method used.

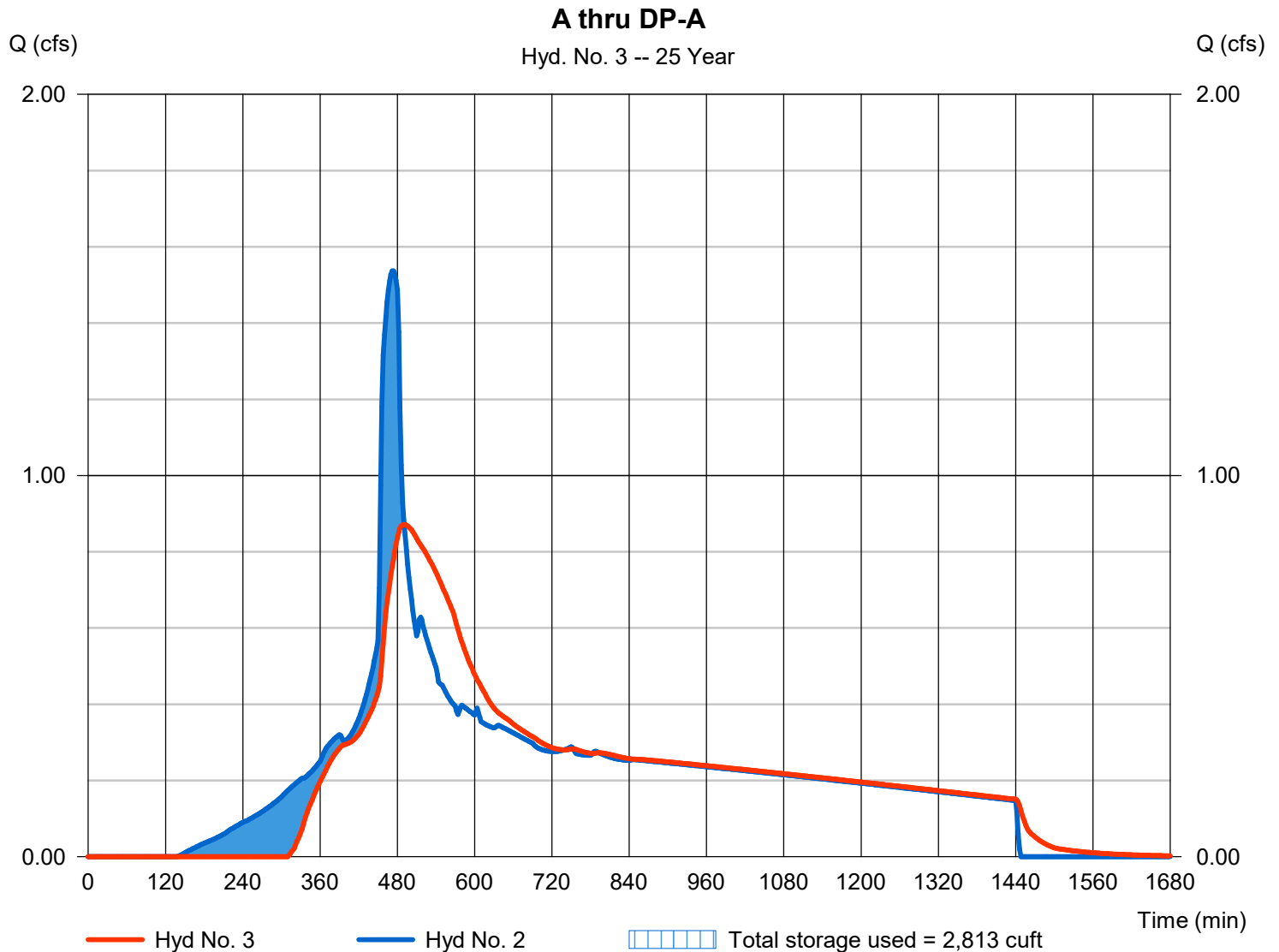

# Hydrograph Report

Hydraflow Hydrographs Extension for Autodesk® Civil 3D® by Autodesk, Inc. v2022

Tuesday, 10 / 24 / 2023

## Hyd. No. 4

Pre Dev-B

Hydrograph type	= SBUH Runoff	Peak discharge	= 0.879 cfs
Storm frequency	= 25 yrs	Time to peak	= 478 min
Time interval	= 2 min	Hyd. volume	= 13,656 cuft
Drainage area	= 1.920 ac	Curve number	= 80
Basin Slope	= 0.0 %	Hydraulic length	= 0 ft
Tc method	= User	Time of conc. (Tc)	= 5.00 min
Total precip.	= 3.90 in	Distribution	= Type IA
Storm duration	= 24 hrs	Shape factor	= n/a

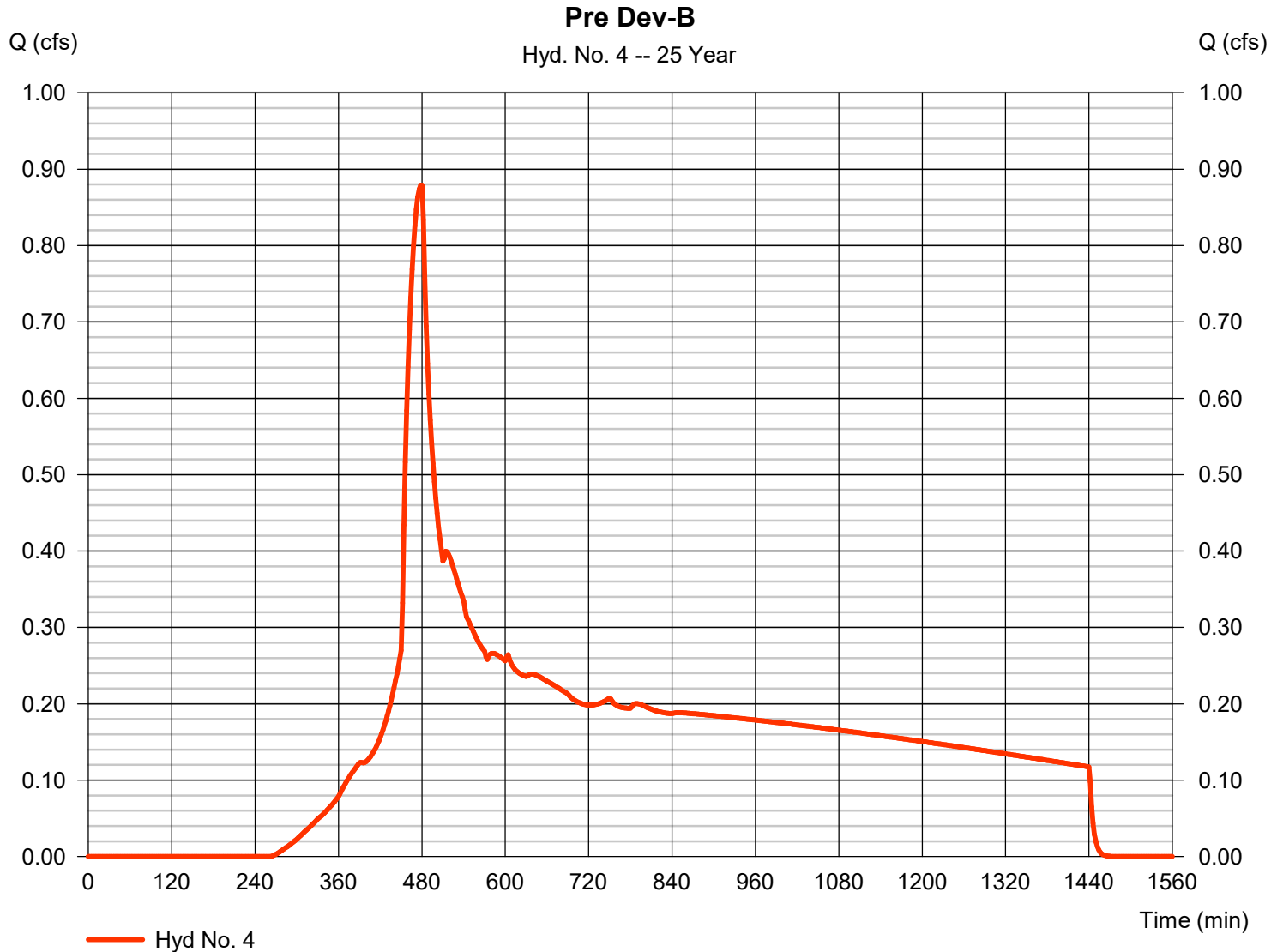

# Hydrograph Report

Hydraflow Hydrographs Extension for Autodesk® Civil 3D® by Autodesk, Inc. v2022

Tuesday, 10 / 24 / 2023

## Hyd. No. 5

Post-Dev-B

Hydrograph type	= SCS Runoff	Peak discharge	= 0.996 cfs
Storm frequency	= 25 yrs	Time to peak	= 474 min
Time interval	= 2 min	Hyd. volume	= 13,995 cuft
Drainage area	= 1.560 ac	Curve number	= 88
Basin Slope	= 0.0 %	Hydraulic length	= 0 ft
Tc method	= User	Time of conc. (Tc)	= 5.00 min
Total precip.	= 3.90 in	Distribution	= Type IA
Storm duration	= 24 hrs	Shape factor	= 484

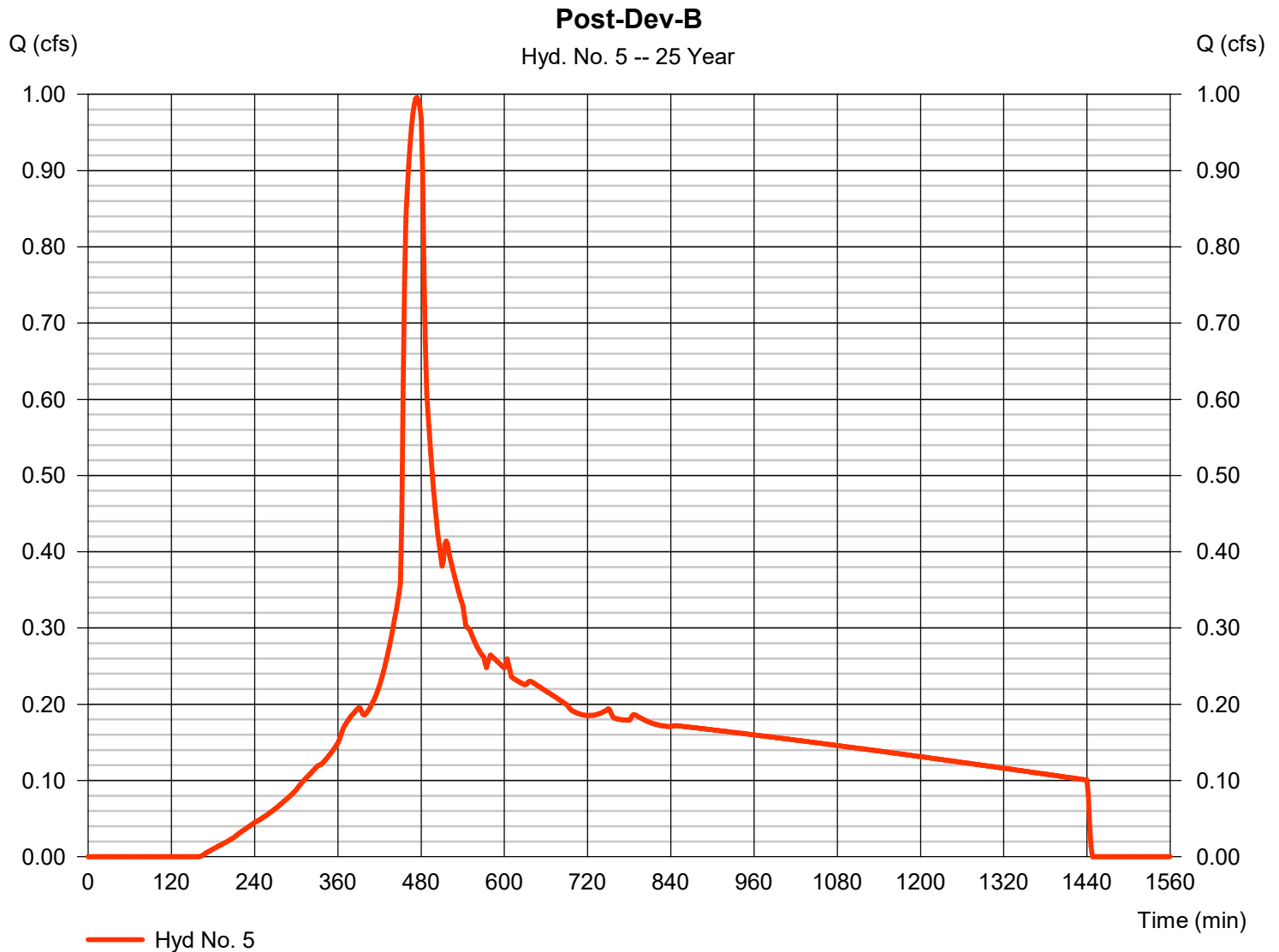

# Hydrograph Report

Hydraflow Hydrographs Extension for Autodesk® Civil 3D® by Autodesk, Inc. v2022

Tuesday, 10 / 24 / 2023

## Hyd. No. 6

B thru DP-B

Hydrograph type	= Reservoir	Peak discharge	= 0.590 cfs
Storm frequency	= 25 yrs	Time to peak	= 490 min
Time interval	= 2 min	Hyd. volume	= 13,988 cuft
Inflow hyd. No.	= 5 - Post-Dev-B	Max. Elevation	= 216.98 ft
Reservoir name	= DP-B	Max. Storage	= 1,496 cuft

Storage Indication method used.

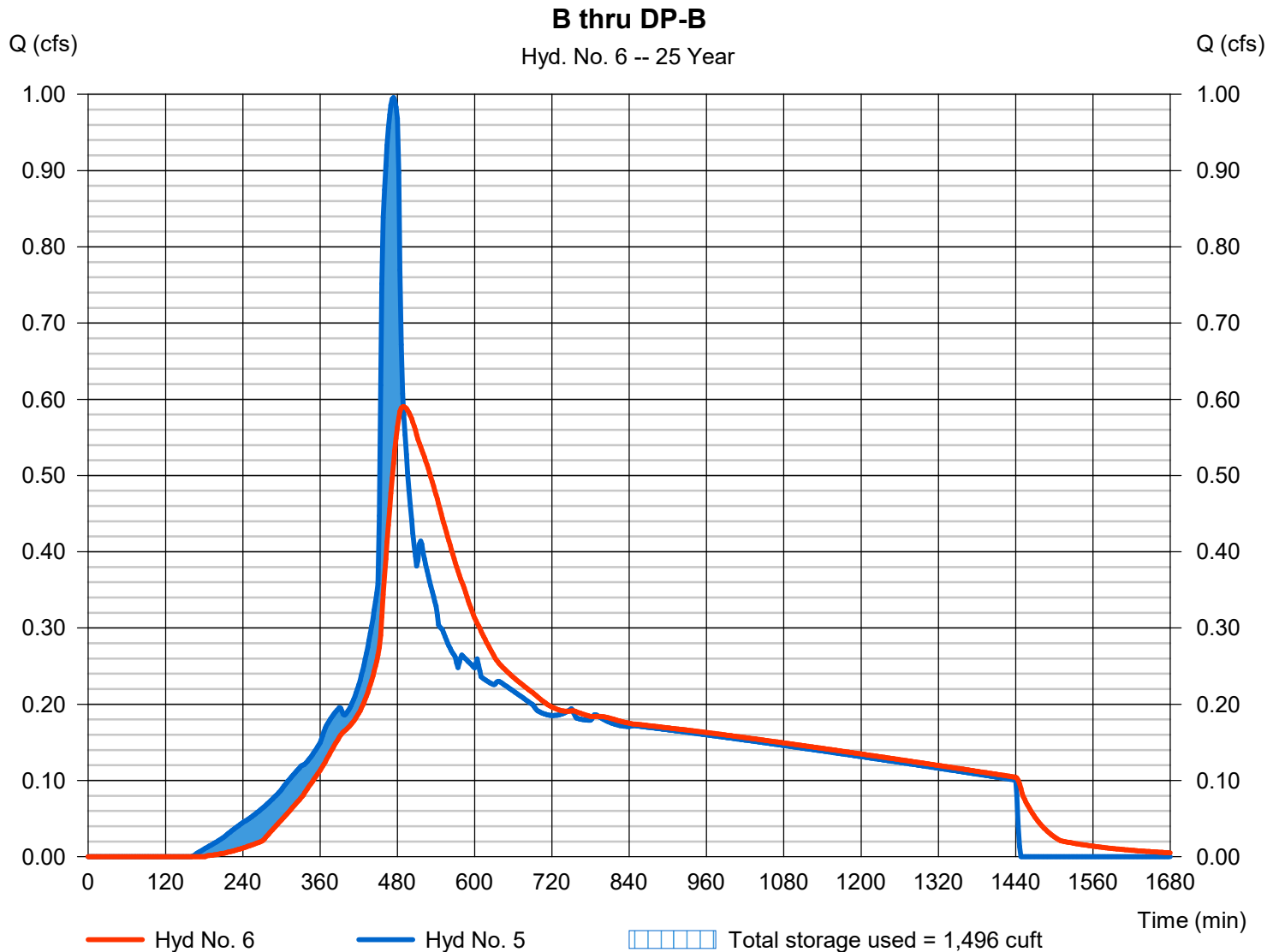

# Hydrograph Summary Report

Hydraflow Hydrographs Extension for Autodesk® Civil 3D® by Autodesk, Inc. v2022

Hyd. No.	Hydrograph type (origin)	Peak flow (cfs)	Time interval (min)	Time to Peak (min)	Hyd. volume (cuft)	Inflow hyd(s)	Maximum elevation (ft)	Total strge used (cuft)	Hydrograph Description
1	SBUH Runoff	1.007	2	478	15,355	-----	-----	-----	Pre-Dev-A
2	SCS Runoff	1.725	2	472	23,914	-----	-----	-----	Post-Dev-A
3	Reservoir	0.937	2	492	23,116	2	215.82	3,152	A thru DP-A
4	SBUH Runoff	1.029	2	478	15,682	-----	-----	-----	Pre Dev-B
5	SCS Runoff	1.125	2	474	15,724	-----	-----	-----	Post-Dev-B
6	Reservoir	0.642	2	490	15,717	5	217.10	1,714	B thru DP-B
20230727-PGE-memorial-DP-A-&-B.gpw					Return Period: 50 Year			Tuesday, 10 / 24 / 2023	

# Hydrograph Report

Hydraflow Hydrographs Extension for Autodesk® Civil 3D® by Autodesk, Inc. v2022

Tuesday, 10 / 24 / 2023

## Hyd. No. 1

Pre-Dev-A

Hydrograph type	= SBUH Runoff	Peak discharge	= 1.007 cfs
Storm frequency	= 50 yrs	Time to peak	= 478 min
Time interval	= 2 min	Hyd. volume	= 15,355 cuft
Drainage area	= 1.880 ac	Curve number	= 80
Basin Slope	= 0.0 %	Hydraulic length	= 0 ft
Tc method	= User	Time of conc. (Tc)	= 5.00 min
Total precip.	= 4.25 in	Distribution	= Type IA
Storm duration	= 24 hrs	Shape factor	= n/a

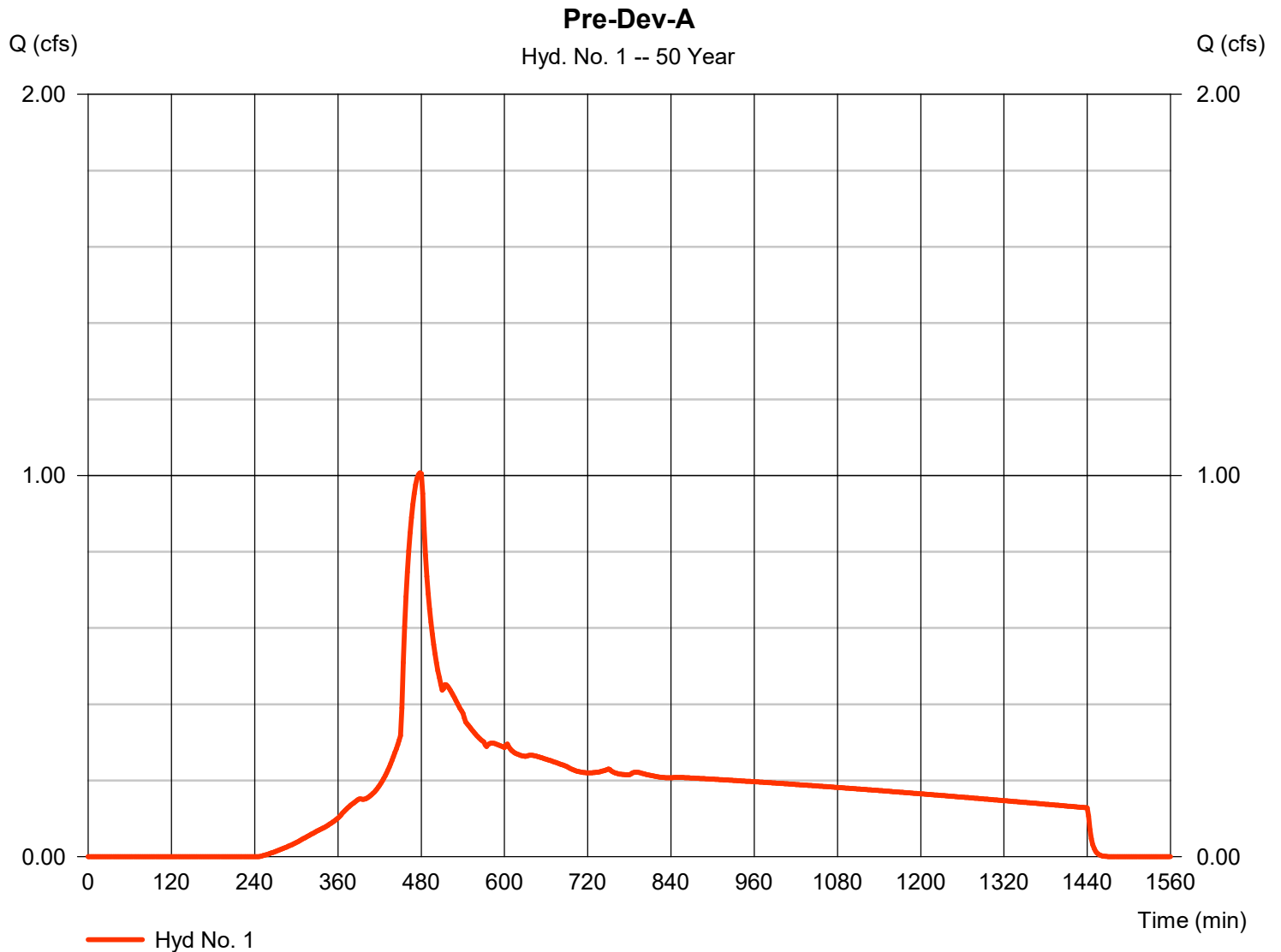

# Hydrograph Report

Hydraflow Hydrographs Extension for Autodesk® Civil 3D® by Autodesk, Inc. v2022

Tuesday, 10 / 24 / 2023

## Hyd. No. 2

Post-Dev-A

Hydrograph type	= SCS Runoff	Peak discharge	= 1.725 cfs
Storm frequency	= 50 yrs	Time to peak	= 472 min
Time interval	= 2 min	Hyd. volume	= 23,914 cuft
Drainage area	= 2.240 ac	Curve number	= 89.8
Basin Slope	= 0.0 %	Hydraulic length	= 0 ft
Tc method	= User	Time of conc. (Tc)	= 5.00 min
Total precip.	= 4.25 in	Distribution	= Type IA
Storm duration	= 24 hrs	Shape factor	= 484

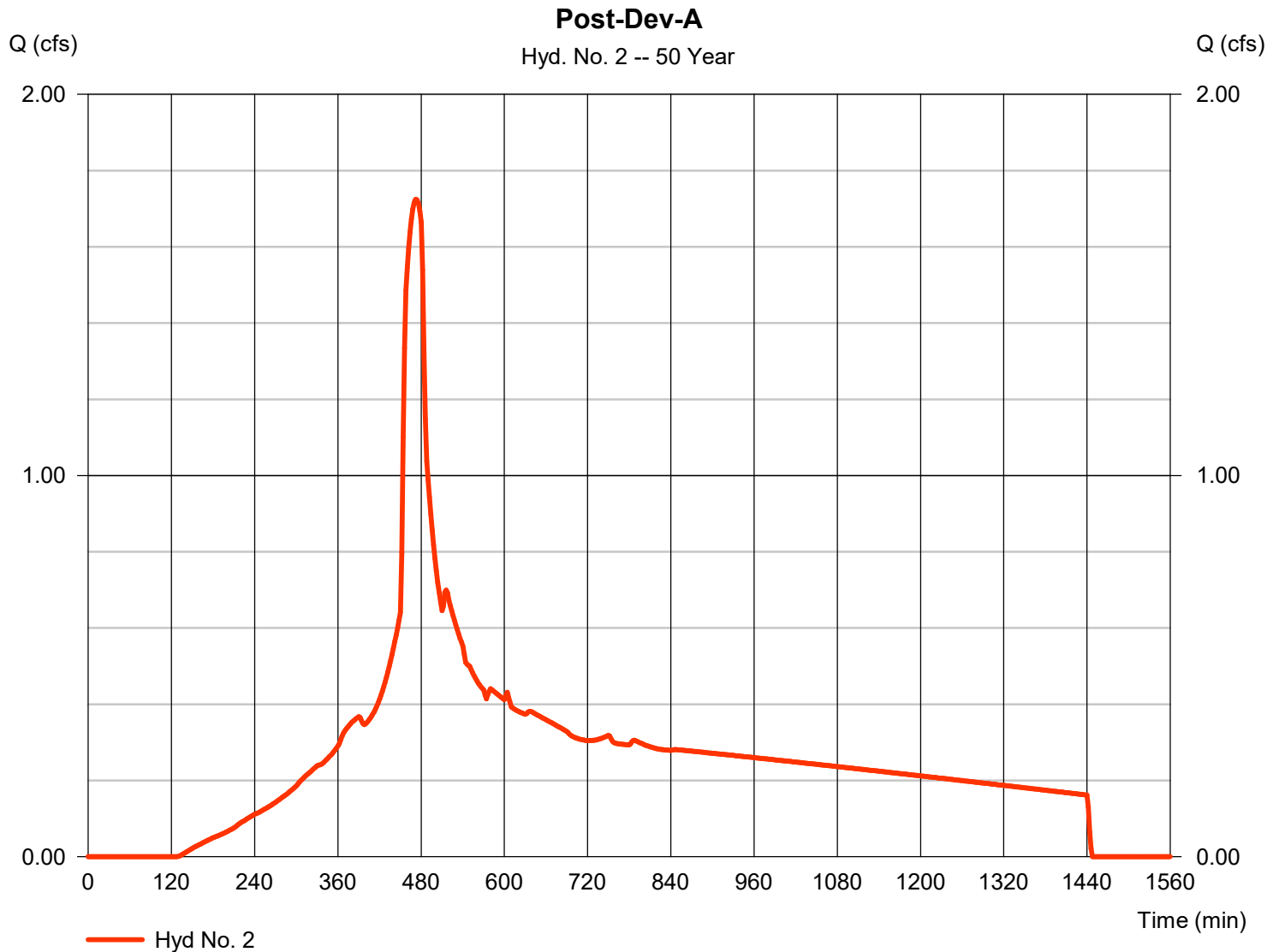

# Hydrograph Report

Hydraflow Hydrographs Extension for Autodesk® Civil 3D® by Autodesk, Inc. v2022

Tuesday, 10 / 24 / 2023

## Hyd. No. 3

A thru DP-A

Hydrograph type	= Reservoir	Peak discharge	= 0.937 cfs
Storm frequency	= 50 yrs	Time to peak	= 492 min
Time interval	= 2 min	Hyd. volume	= 23,116 cuft
Inflow hyd. No.	= 2 - Post-Dev-A	Max. Elevation	= 215.82 ft
Reservoir name	= DP-A	Max. Storage	= 3,152 cuft

Storage Indication method used.

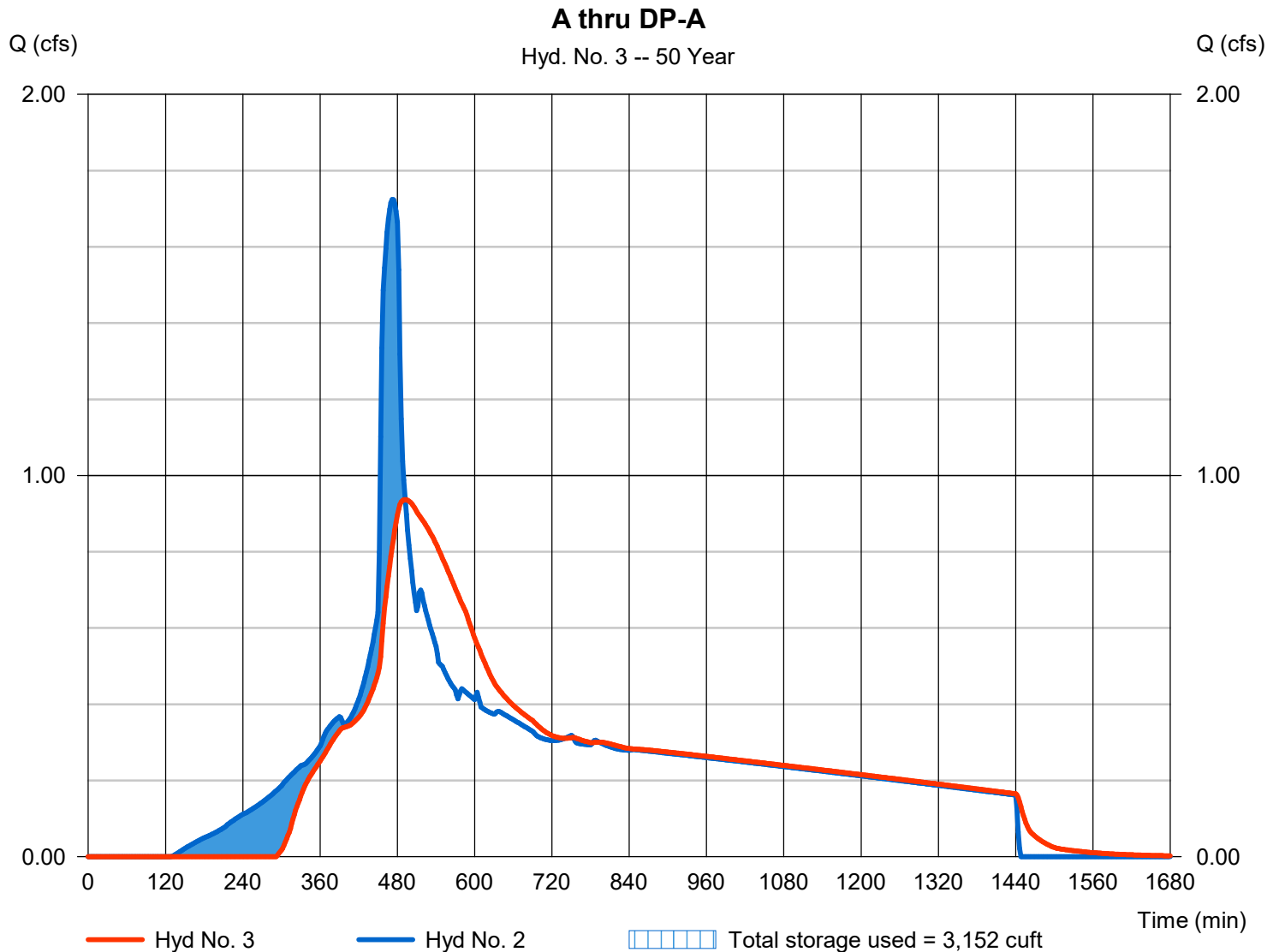



# Hydrograph Report

Hydraflow Hydrographs Extension for Autodesk® Civil 3D® by Autodesk, Inc. v2022

Tuesday, 10 / 24 / 2023

## Hyd. No. 4

Pre Dev-B

Hydrograph type	= SBUH Runoff	Peak discharge	= 1.029 cfs
Storm frequency	= 50 yrs	Time to peak	= 478 min
Time interval	= 2 min	Hyd. volume	= 15,682 cuft
Drainage area	= 1.920 ac	Curve number	= 80
Basin Slope	= 0.0 %	Hydraulic length	= 0 ft
Tc method	= User	Time of conc. (Tc)	= 5.00 min
Total precip.	= 4.25 in	Distribution	= Type IA
Storm duration	= 24 hrs	Shape factor	= n/a

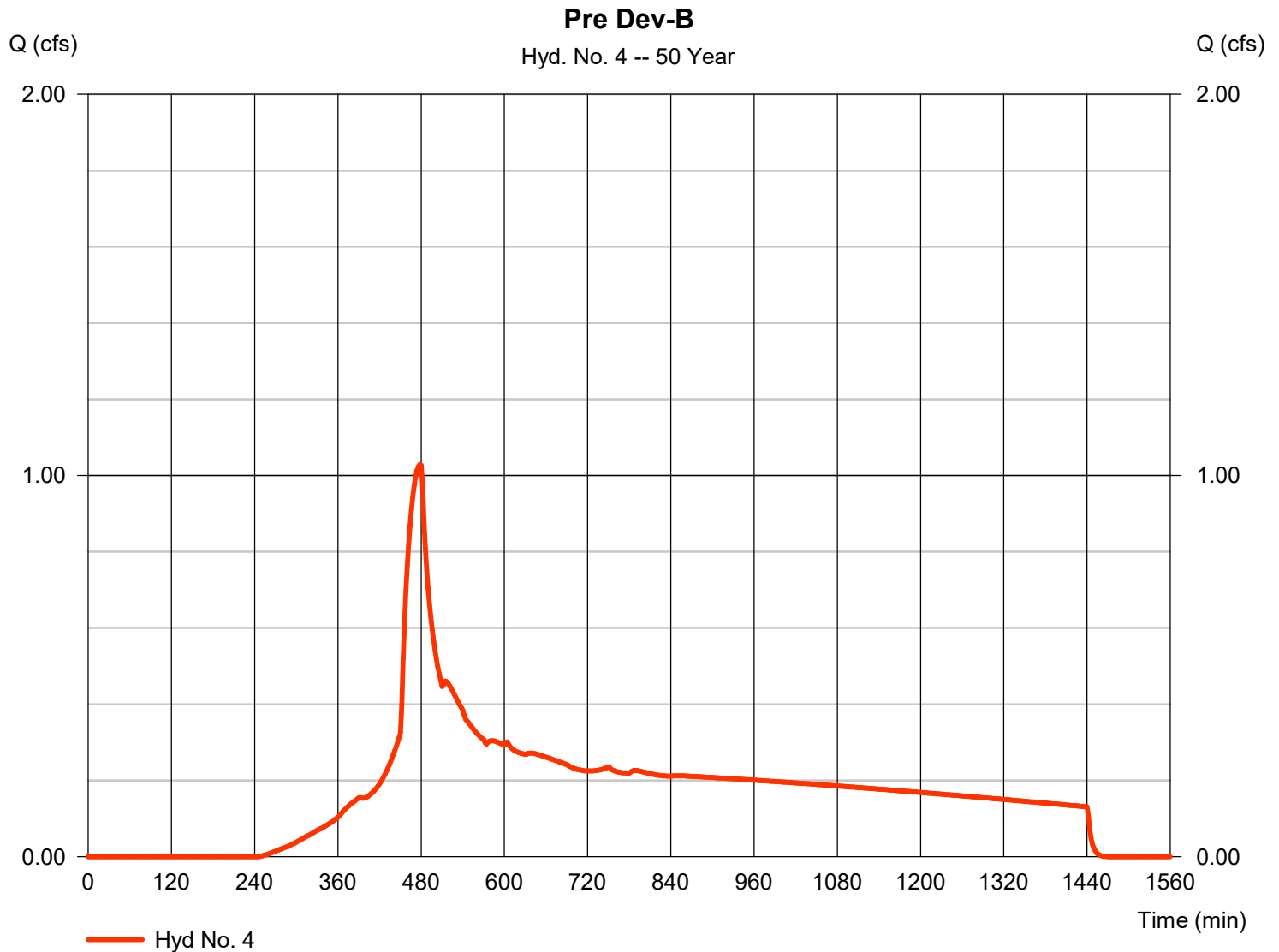

# Hydrograph Report

Hydraflow Hydrographs Extension for Autodesk® Civil 3D® by Autodesk, Inc. v2022

Tuesday, 10 / 24 / 2023

## Hyd. No. 5

Post-Dev-B

Hydrograph type	= SCS Runoff	Peak discharge	= 1.125 cfs
Storm frequency	= 50 yrs	Time to peak	= 474 min
Time interval	= 2 min	Hyd. volume	= 15,724 cuft
Drainage area	= 1.560 ac	Curve number	= 88
Basin Slope	= 0.0 %	Hydraulic length	= 0 ft
Tc method	= User	Time of conc. (Tc)	= 5.00 min
Total precip.	= 4.25 in	Distribution	= Type IA
Storm duration	= 24 hrs	Shape factor	= 484

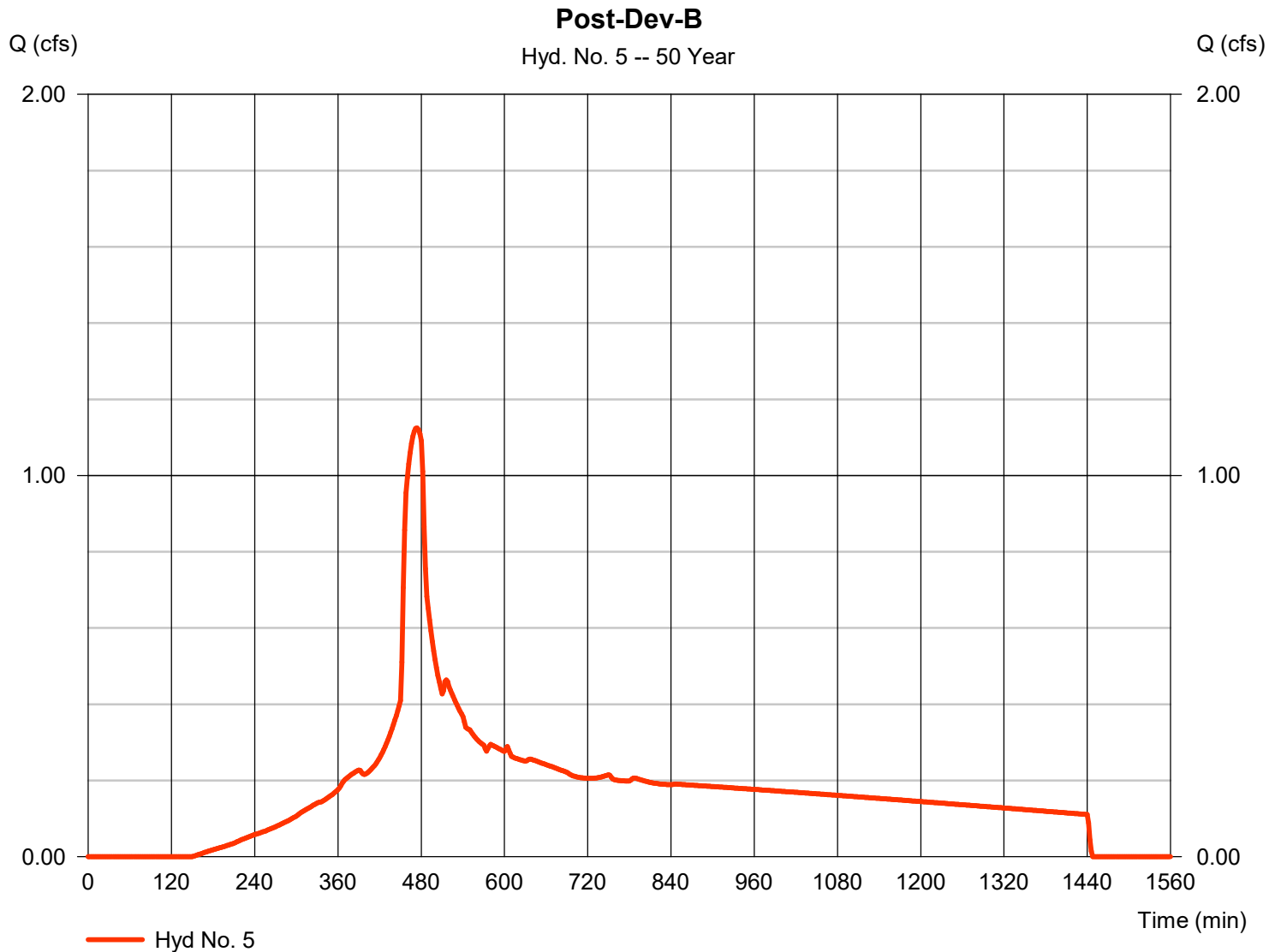

# Hydrograph Report

Hydraflow Hydrographs Extension for Autodesk® Civil 3D® by Autodesk, Inc. v2022

Tuesday, 10 / 24 / 2023

## Hyd. No. 6

B thru DP-B

Hydrograph type	= Reservoir	Peak discharge	= 0.642 cfs
Storm frequency	= 50 yrs	Time to peak	= 490 min
Time interval	= 2 min	Hyd. volume	= 15,717 cuft
Inflow hyd. No.	= 5 - Post-Dev-B	Max. Elevation	= 217.10 ft
Reservoir name	= DP-B	Max. Storage	= 1,714 cuft

Storage Indication method used.

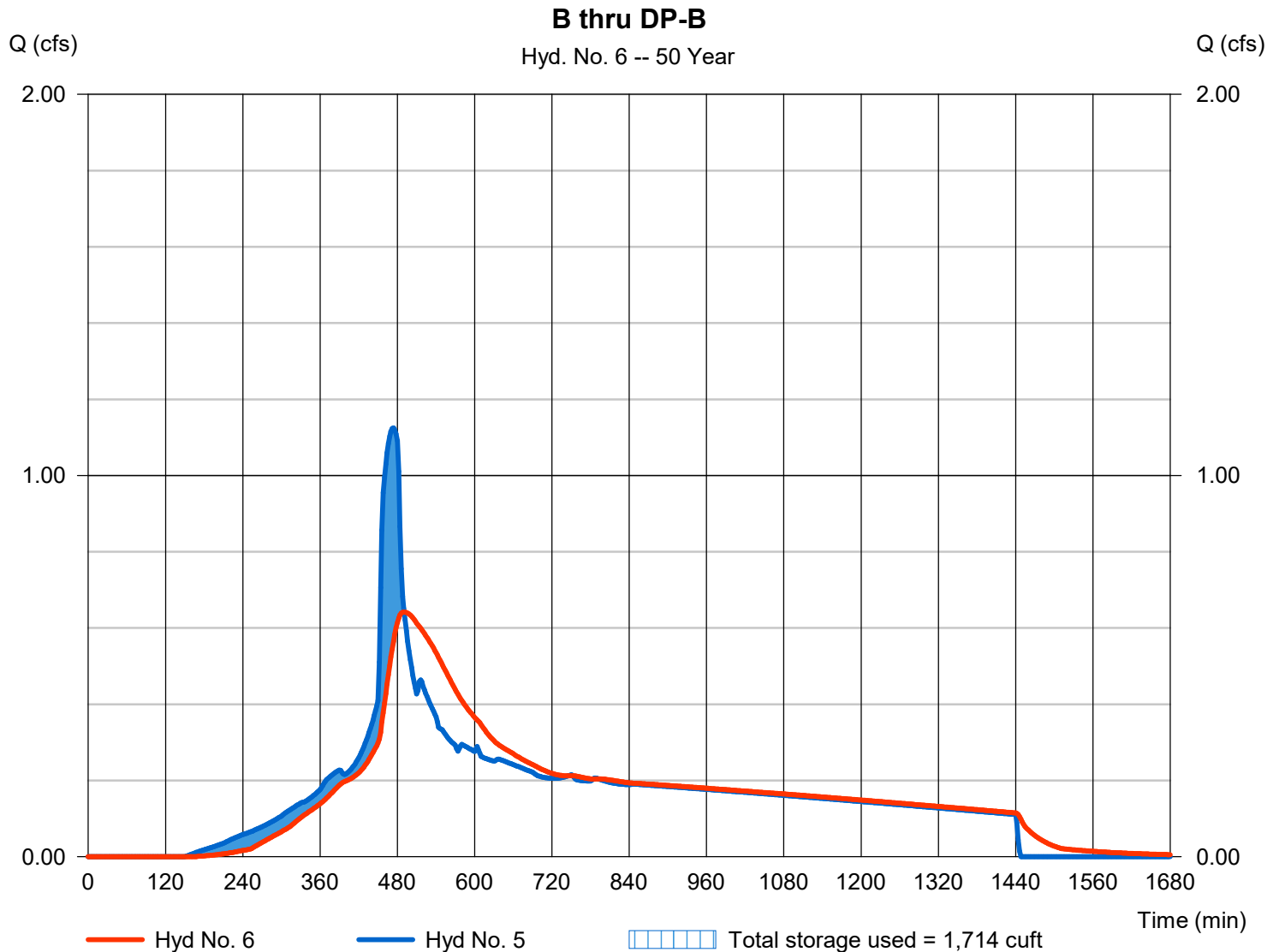

# Hydrograph Summary Report

Hydraflow Hydrographs Extension for Autodesk® Civil 3D® by Autodesk, Inc. v2022

Hyd. No.	Hydrograph type (origin)	Peak flow (cfs)	Time interval (min)	Time to Peak (min)	Hyd. volume (cuft)	Inflow hyd(s)	Maximum elevation (ft)	Total strge used (cuft)	Hydrograph Description	
1	SBUH Runoff	1.114	2	478	16,799	-----	-----	-----	Pre-Dev-A	
2	SCS Runoff	1.859	2	472	25,731	-----	-----	-----	Post-Dev-A	
3	Reservoir	0.983	2	494	24,933	2	215.97	3,404	A thru DP-A	
4	SBUH Runoff	1.137	2	478	17,156	-----	-----	-----	Pre Dev-B	
5	SCS Runoff	1.217	2	474	16,968	-----	-----	-----	Post-Dev-B	
6	Reservoir	0.677	2	492	16,961	5	217.19	1,879	B thru DP-B	
20230727-PGE-memorial-DP-A-&-B.gpw					Return Period: 100 Year			Tuesday, 10 / 24 / 2023		

# Hydrograph Report

Hydraflow Hydrographs Extension for Autodesk® Civil 3D® by Autodesk, Inc. v2022

Tuesday, 10 / 24 / 2023

## Hyd. No. 1

Pre-Dev-A

Hydrograph type	= SBUH Runoff	Peak discharge	= 1.114 cfs
Storm frequency	= 100 yrs	Time to peak	= 478 min
Time interval	= 2 min	Hyd. volume	= 16,799 cuft
Drainage area	= 1.880 ac	Curve number	= 80
Basin Slope	= 0.0 %	Hydraulic length	= 0 ft
Tc method	= User	Time of conc. (Tc)	= 5.00 min
Total precip.	= 4.50 in	Distribution	= Type IA
Storm duration	= 24 hrs	Shape factor	= n/a

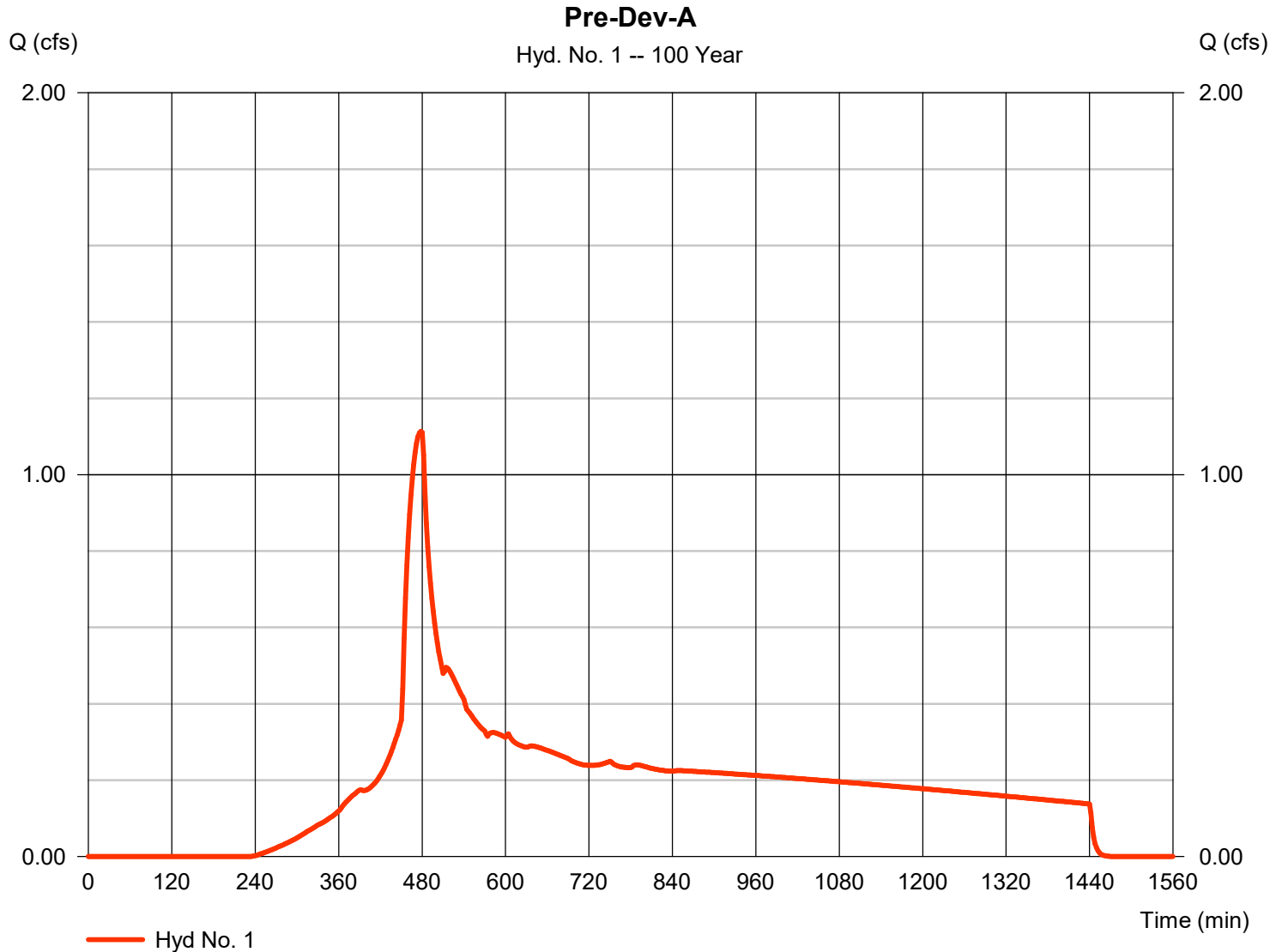

# Hydrograph Report

Hydraflow Hydrographs Extension for Autodesk® Civil 3D® by Autodesk, Inc. v2022

Tuesday, 10 / 24 / 2023

## Hyd. No. 2

Post-Dev-A

Hydrograph type	= SCS Runoff	Peak discharge	= 1.859 cfs
Storm frequency	= 100 yrs	Time to peak	= 472 min
Time interval	= 2 min	Hyd. volume	= 25,731 cuft
Drainage area	= 2.240 ac	Curve number	= 89.8
Basin Slope	= 0.0 %	Hydraulic length	= 0 ft
Tc method	= User	Time of conc. (Tc)	= 5.00 min
Total precip.	= 4.50 in	Distribution	= Type IA
Storm duration	= 24 hrs	Shape factor	= 484

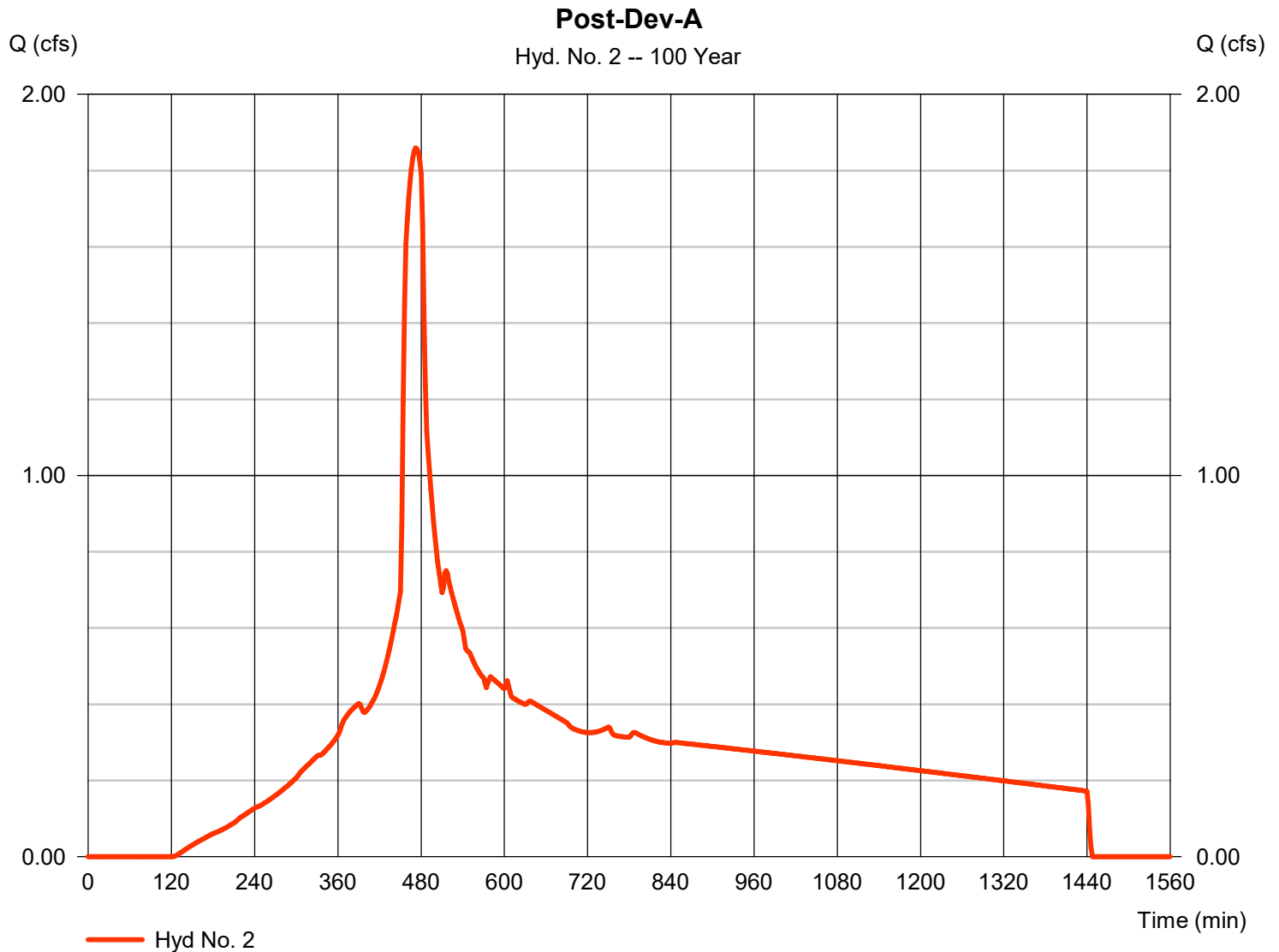

# Hydrograph Report

Hydraflow Hydrographs Extension for Autodesk® Civil 3D® by Autodesk, Inc. v2022

Tuesday, 10 / 24 / 2023

## Hyd. No. 3

A thru DP-A

Hydrograph type	= Reservoir	Peak discharge	= 0.983 cfs
Storm frequency	= 100 yrs	Time to peak	= 494 min
Time interval	= 2 min	Hyd. volume	= 24,933 cuft
Inflow hyd. No.	= 2 - Post-Dev-A	Max. Elevation	= 215.97 ft
Reservoir name	= DP-A	Max. Storage	= 3,404 cuft

Storage Indication method used.

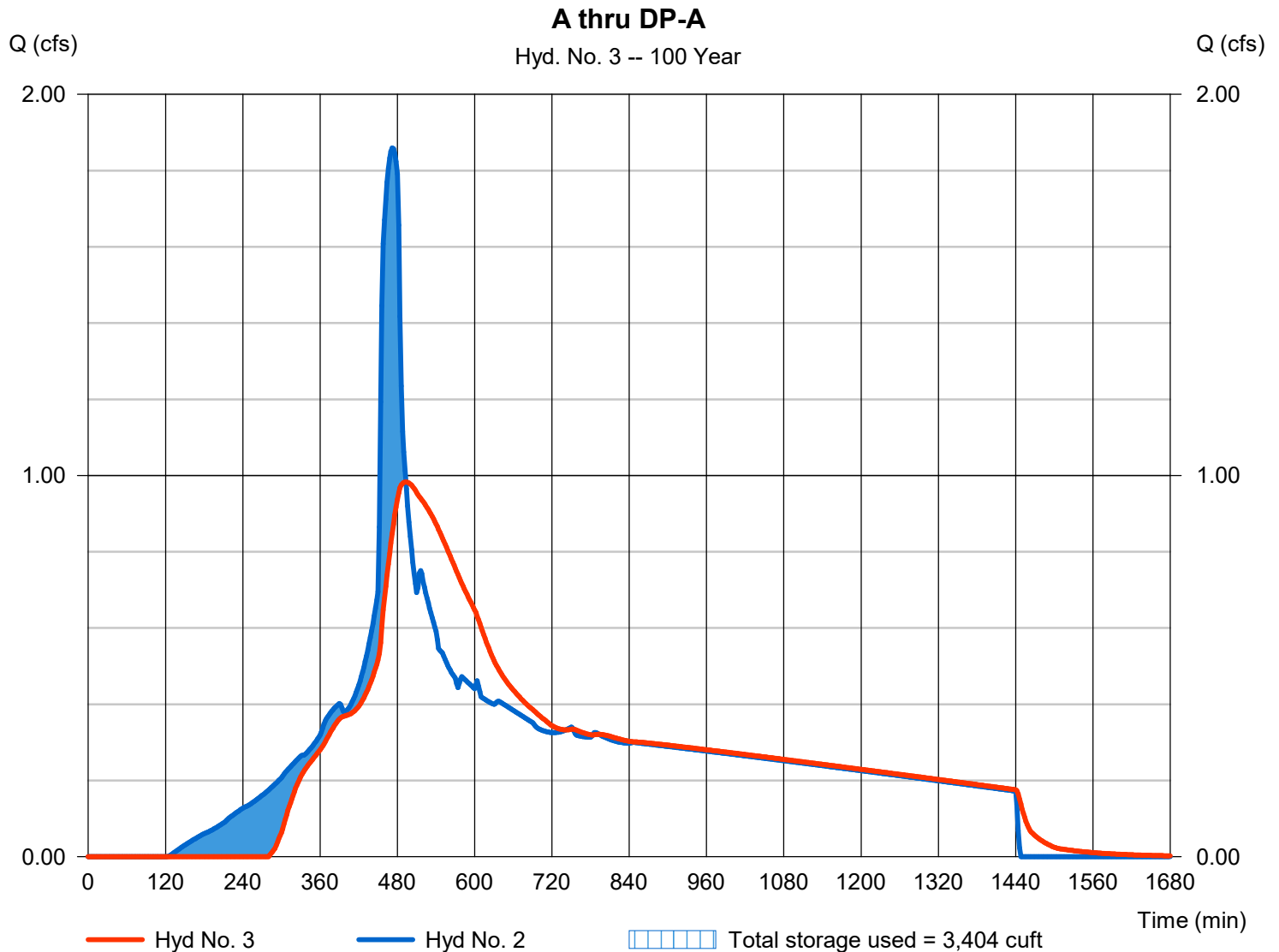

# Hydrograph Report

Hydraflow Hydrographs Extension for Autodesk® Civil 3D® by Autodesk, Inc. v2022

Tuesday, 10 / 24 / 2023

## Hyd. No. 4

Pre Dev-B

Hydrograph type	= SBUH Runoff	Peak discharge	= 1.137 cfs
Storm frequency	= 100 yrs	Time to peak	= 478 min
Time interval	= 2 min	Hyd. volume	= 17,156 cuft
Drainage area	= 1.920 ac	Curve number	= 80
Basin Slope	= 0.0 %	Hydraulic length	= 0 ft
Tc method	= User	Time of conc. (Tc)	= 5.00 min
Total precip.	= 4.50 in	Distribution	= Type IA
Storm duration	= 24 hrs	Shape factor	= n/a

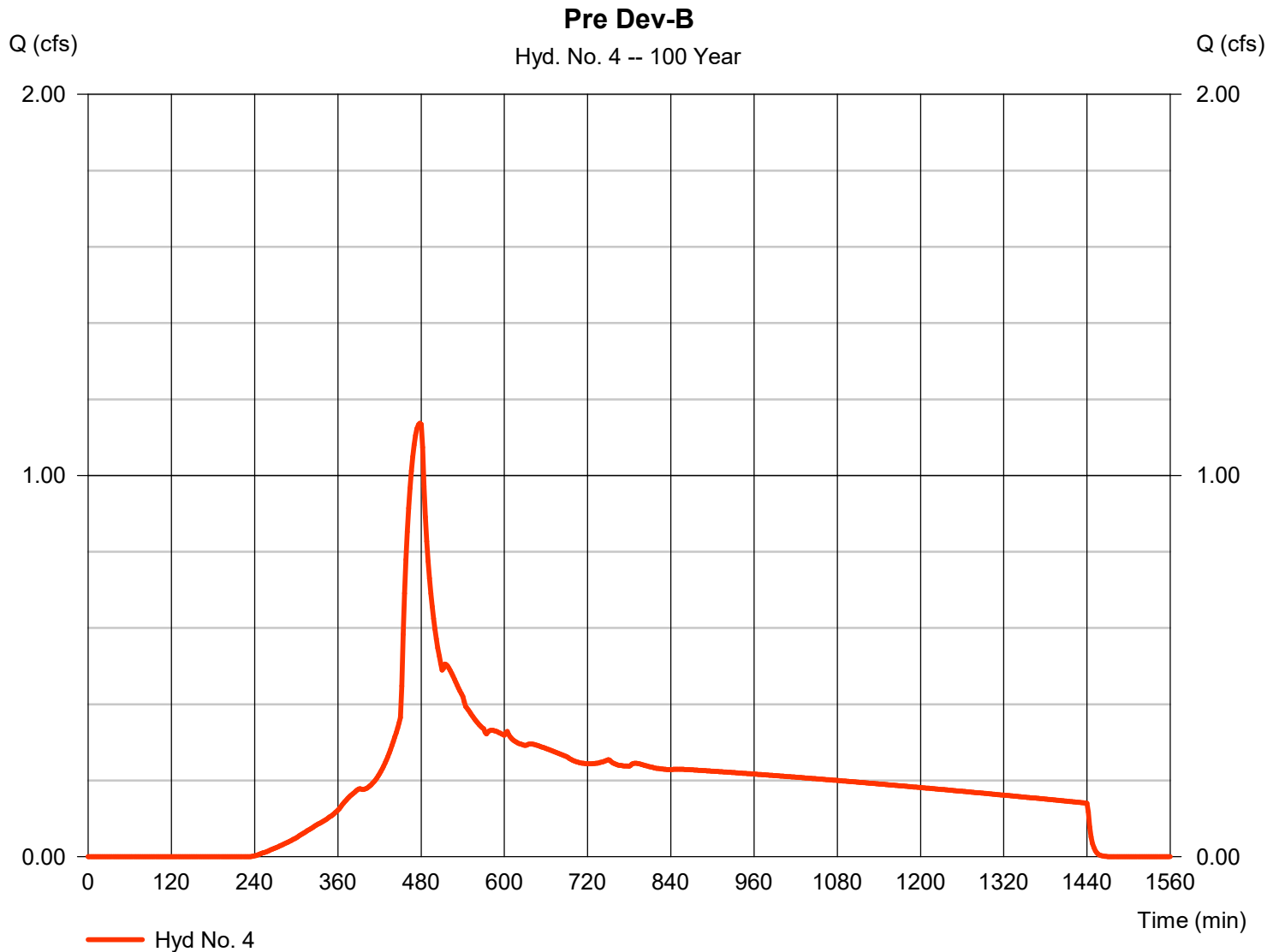



# Hydrograph Report

Hydraflow Hydrographs Extension for Autodesk® Civil 3D® by Autodesk, Inc. v2022

Tuesday, 10 / 24 / 2023

## Hyd. No. 5

Post-Dev-B

Hydrograph type	= SCS Runoff	Peak discharge	= 1.217 cfs
Storm frequency	= 100 yrs	Time to peak	= 474 min
Time interval	= 2 min	Hyd. volume	= 16,968 cuft
Drainage area	= 1.560 ac	Curve number	= 88
Basin Slope	= 0.0 %	Hydraulic length	= 0 ft
Tc method	= User	Time of conc. (Tc)	= 5.00 min
Total precip.	= 4.50 in	Distribution	= Type IA
Storm duration	= 24 hrs	Shape factor	= 484

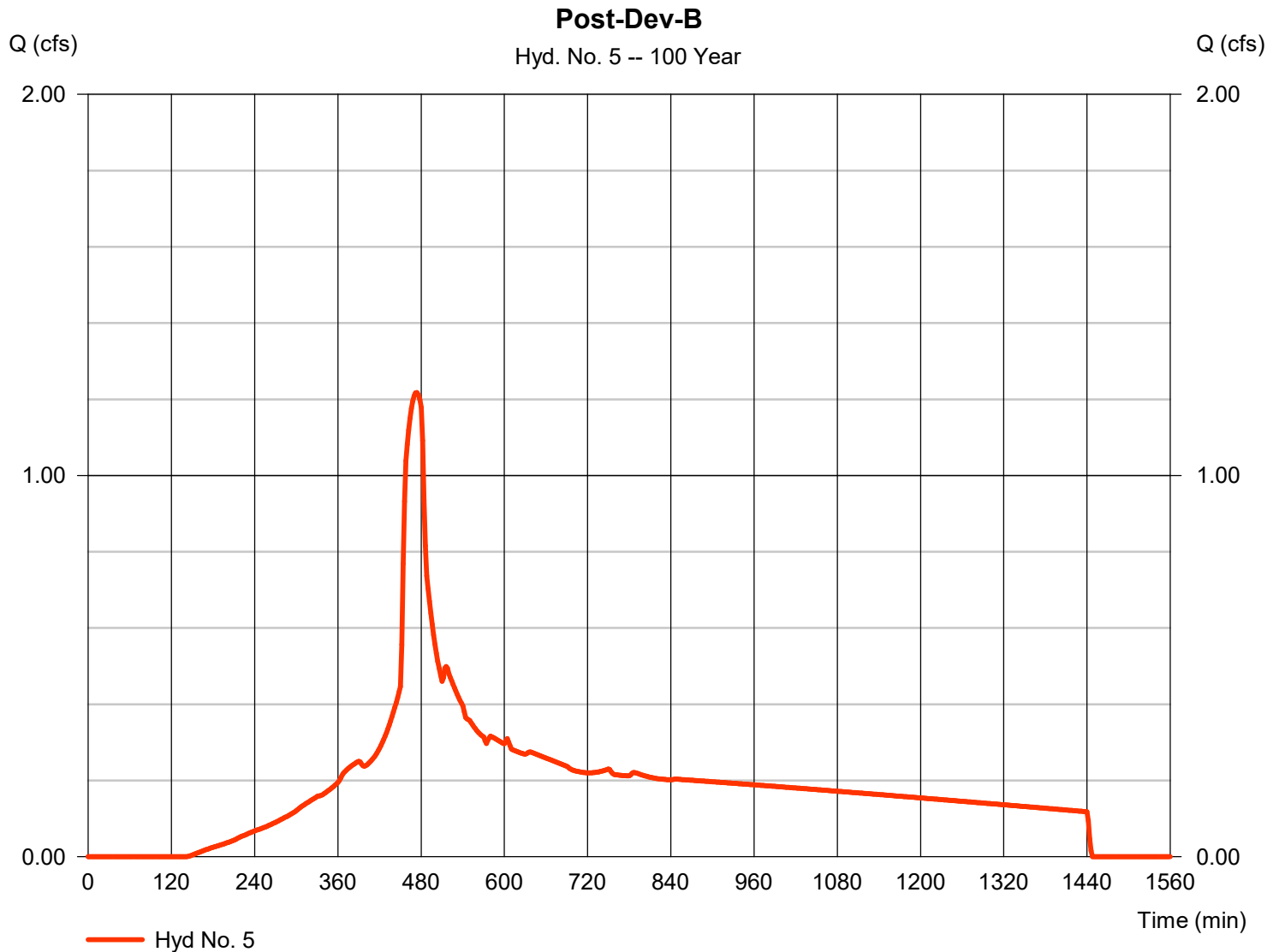

# Hydrograph Report

Hydraflow Hydrographs Extension for Autodesk® Civil 3D® by Autodesk, Inc. v2022

Tuesday, 10 / 24 / 2023

## Hyd. No. 6

B thru DP-B

Hydrograph type	= Reservoir	Peak discharge	= 0.677 cfs
Storm frequency	= 100 yrs	Time to peak	= 492 min
Time interval	= 2 min	Hyd. volume	= 16,961 cuft
Inflow hyd. No.	= 5 - Post-Dev-B	Max. Elevation	= 217.19 ft
Reservoir name	= DP-B	Max. Storage	= 1,879 cuft

Storage Indication method used.

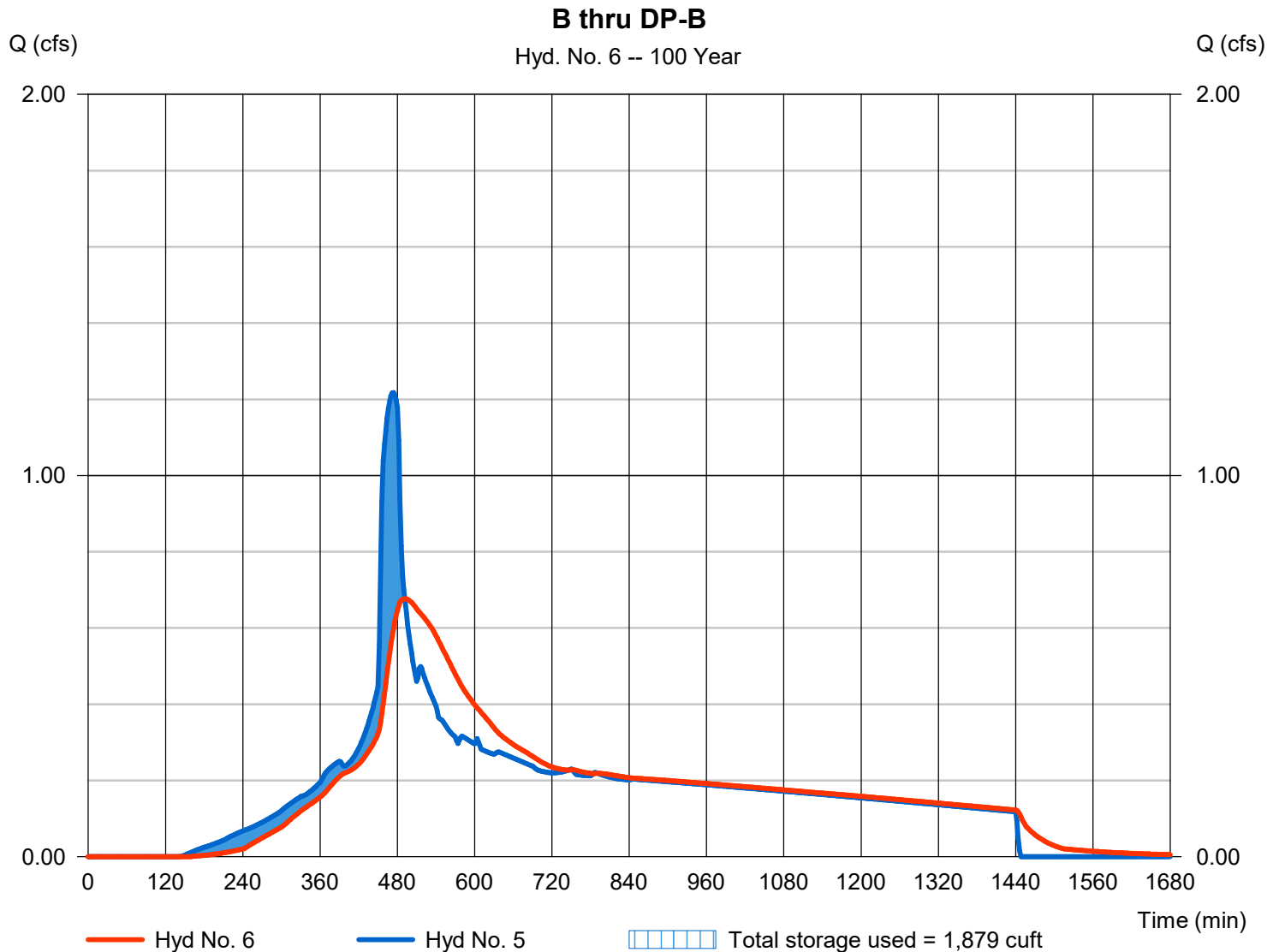

## **Appendix C**

C1-Hydrologic Soil Group

C2- Rainfall Distribution

Hydrologic Soil Group—Clackamas County Area, Oregon



Soil Map may not be valid at this scale.

Map Scale: 1:1,770 if printed on A landscape (11" x 8.5") sheet.

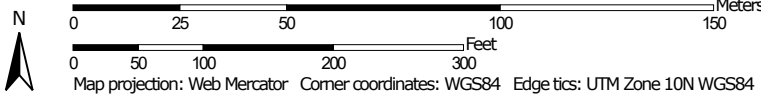

## Hydrologic Soil Group—Clackamas County Area, Oregon

## MAP LEGEND

## Area of Interest (AOI)









 Area of Interest (AOI)

## Soils

## Soil Rating Polygons





 A  
 A/D  
 B  
 B/D  
 C  
 C/D  
 D  
 Not rated or not available

## Soil Rating Lines

 A  
 A/D  
 B  
 B/D  
 C  
 C/D  
 D  
 Not rated or not available

## Soil Rating Points





 A  
 A/D  
 B  
 B/D

 C  
 C/D  
 D  
 Not rated or not available

## Water Features

 Streams and Canals

## Transportation

 Rails  
 Interstate Highways  
 US Routes  
 Major Roads  
 Local Roads

## Background

 Aerial Photography

## MAP INFORMATION

The soil surveys that comprise your AOI were mapped at 1:20,000.

Warning: Soil Map may not be valid at this scale.

Enlargement of maps beyond the scale of mapping can cause misunderstanding of the detail of mapping and accuracy of soil line placement. The maps do not show the small areas of contrasting soils that could have been shown at a more detailed scale.

Please rely on the bar scale on each map sheet for map measurements.

Source of Map: Natural Resources Conservation Service  
 Web Soil Survey URL:  
 Coordinate System: Web Mercator (EPSG:3857)

Maps from the Web Soil Survey are based on the Web Mercator projection, which preserves direction and shape but distorts distance and area. A projection that preserves area, such as the Albers equal-area conic projection, should be used if more accurate calculations of distance or area are required.

This product is generated from the USDA-NRCS certified data as of the version date(s) listed below.

Soil Survey Area: Clackamas County Area, Oregon  
 Survey Area Data: Version 19, Sep 14, 2022

Soil map units are labeled (as space allows) for map scales 1:50,000 or larger.

Date(s) aerial images were photographed: Apr 16, 2021—Apr 18, 2021

The orthophoto or other base map on which the soil lines were compiled and digitized probably differs from the background imagery displayed on these maps. As a result, some minor shifting of map unit boundaries may be evident.

## Hydrologic Soil Group

Map unit symbol	Map unit name	Rating	Acres in AOI	Percent of AOI
1A	Aloha silt loam, 0 to 3 percent slopes	C/D	10.0	82.4%
3	Amity silt loam	C/D	1.5	12.2%
2225A	Huberly silt loam, 0 to 3 percent slopes	C/D	0.7	5.4%
<b>Totals for Area of Interest</b>			<b>12.2</b>	<b>100.0%</b>

### Description

Hydrologic soil groups are based on estimates of runoff potential. Soils are assigned to one of four groups according to the rate of water infiltration when the soils are not protected by vegetation, are thoroughly wet, and receive precipitation from long-duration storms.

The soils in the United States are assigned to four groups (A, B, C, and D) and three dual classes (A/D, B/D, and C/D). The groups are defined as follows:

Group A. Soils having a high infiltration rate (low runoff potential) when thoroughly wet. These consist mainly of deep, well drained to excessively drained sands or gravelly sands. These soils have a high rate of water transmission.

Group B. Soils having a moderate infiltration rate when thoroughly wet. These consist chiefly of moderately deep or deep, moderately well drained or well drained soils that have moderately fine texture to moderately coarse texture. These soils have a moderate rate of water transmission.

Group C. Soils having a slow infiltration rate when thoroughly wet. These consist chiefly of soils having a layer that impedes the downward movement of water or soils of moderately fine texture or fine texture. These soils have a slow rate of water transmission.

Group D. Soils having a very slow infiltration rate (high runoff potential) when thoroughly wet. These consist chiefly of clays that have a high shrink-swell potential, soils that have a high water table, soils that have a claypan or clay layer at or near the surface, and soils that are shallow over nearly impervious material. These soils have a very slow rate of water transmission.

If a soil is assigned to a dual hydrologic group (A/D, B/D, or C/D), the first letter is for drained areas and the second is for undrained areas. Only the soils that in their natural condition are in group D are assigned to dual classes.

## Rating Options

*Aggregation Method:* Dominant Condition

*Component Percent Cutoff:* None Specified

*Tie-break Rule:* Higher

**TABLE 3.3. RAINFALL DISTRIBUTION**

<b>Recurrence Interval (years)</b>	<b>Total Precipitation Depth (inches)</b>
2	2.50
5	3.00
10	3.45
25	3.90
50	4.25
100	4.50



Page intentionally left blank for double-sided printing.

# Appendix D

## Geotechnical Reports



SUBMITTED TO:  
POWER Engineers, Inc.  
3940 Glenbrook Drive  
Hailey, ID 83333



BY:  
Shannon & Wilson, Inc.  
3990 Collins Way, Suite 100  
Lake Oswego, OR 97035

(503) 210-4750  
[www.shannonwilson.com](http://www.shannonwilson.com)

GEOTECHNICAL INVESTIGATION REPORT  
PGE Memorial Substation  
WILSONVILLE, OREGON



PAGE INTENTIONALLY LEFT BLANK FOR DOUBLE-SIDED PRINTING

Submitted To: POWER Engineers, Inc.  
3940 Glenbrook Drive  
Hailey, ID 83333  
Attn: Kurt Penberthy, PE

Subject: GEOTECHNICAL INVESTIGATION REPORT, PGE MEMORIAL  
SUBSTATION, WILSONVILLE, OREGON

This report presents the results of Shannon & Wilson, Inc. (Shannon & Wilson)'s geotechnical study to support engineering, design, and construction of the Portland General Electric (PGE) Memorial Substation Project. Shannon & Wilson prepared this report and participated in this project as a subconsultant to POWER Engineers, Inc. (POWER Engineers). Our scope of services was specified in General Services Agreement (Document "007-10327") for Geotechnical Services, dated October 23, 2020, and Task Order Number 002 dated August 17, 2022.

We appreciate the opportunity to be of service to you on this project. If you have questions concerning this report, or if we may be of further service, please contact us.

Sincerely,

SHANNON & WILSON, INC.



Cody K. Sorensen, CEG  
Associate Engineering Geologist



Elliott C. Mecham, PE  
Senior Associate

CKS:ECM:myw:mmb

## CONTENTS

<b>1</b>	<b>Project Understanding.....</b>	<b>1</b>
1.1	Project Description.....	1
1.2	Site Description.....	2
1.3	Scope of Services .....	4
<b>2</b>	<b>Geology and Seismic Setting .....</b>	<b>4</b>
2.1	Regional Geology .....	4
2.2	Local Geology .....	6
2.3	Seismic Setting.....	6
2.3.1	Local Quaternary Faults and Folds.....	6
<b>3</b>	<b>Exploration Program .....</b>	<b>8</b>
3.1	Field Explorations .....	8
3.2	In-Situ Infiltration Testing .....	9
3.3	Geotechnical Laboratory Testing.....	9
3.4	Thermal Resistivity Testing .....	9
<b>4</b>	<b>Summary of Subsurface Conditions.....</b>	<b>10</b>
4.1	Geotechnical Units .....	10
4.1.1	Fill .....	11
4.1.2	Missoula Flood Deposits .....	11
4.1.3	Troutdale Formation.....	12
4.2	Groundwater.....	12
<b>5</b>	<b>Geologic and Seismic Hazards.....</b>	<b>13</b>
5.1	Landslide Hazard.....	13
5.2	Flooding Hazard .....	14
5.3	Seismic Design Parameters .....	14
5.4	Seismic Hazards .....	15
5.4.1	Liquefaction.....	15
5.4.2	Fault Rupture .....	16
5.4.3	Slope Instability .....	16
<b>6</b>	<b>Geotechnical Design Recommendations .....</b>	<b>16</b>
6.1	General.....	16

6.2	Shallow Foundations .....	17
6.2.1	Bearing Capacity.....	17
6.2.2	Settlement.....	17
6.2.3	Uplift Resistance.....	18
6.2.4	Lateral Resistance.....	18
6.3	Deep Foundations .....	18
6.3.1	Axial Resistance.....	19
6.3.2	Lateral Resistance Parameters .....	19
7	Construction Considerations.....	19
7.1	Site Preparation and Earthwork.....	19
7.1.1	Stripping and Grubbing .....	19
7.1.2	Reuse of On-site Material .....	19
7.1.3	Foundation Subgrade Preparation.....	20
7.2	Wet Weather Earthwork .....	21
7.3	Drilled Shaft Construction Considerations .....	21
7.3.1	General.....	21
7.3.2	Drilled Shaft Quality Control .....	22
8	Additional Services.....	22
9	Limitations .....	22
10	References .....	24
Exhibits		
	Exhibit 1-1: Estimated foundation loads and allowable settlement provided by Power Engineers.....	1
	Exhibit 1-2: View of the west side of the site with berm in background from boring B-03.....	2
	Exhibit 1-3: View of north side of the site from boring B-06.....	3
	Exhibit 1-4: View of the east and south sides of the site from boring B-03.....	3
	Exhibit 1-5: View of the northeast corner of the site from the large oak tree along SW Parkway Ave. ....	4
	Exhibit 2-1: USGS Quaternary Faults or Folds Within an Approximate 30-mile Radius of the Project Site.....	8
	Exhibit 4-1: Well Log information compiled from the Oregon Water Resources Department .....	13

Exhibit 5-1: Recommended Seismic Design Parameters .....	15
--	----

#### Tables

Table 1:	Presumptive Stratigraphic Characterization Values
Table 2:	L-Pile and Axial Capacity Parameters

#### Figures

Figure 1:	Vicinity Map
Figure 2:	Site and Exploration Plan

#### Appendices

Appendix A:	Conceptual Plans
Appendix B:	Field Explorations
Appendix C:	Laboratory Test Results
Important Information	



## ACRONYMS

ASCE	American Society of Civil Engineers
bgs	below ground surface
bpf	blows per foot
CSZ	Cascadia Subduction Zone
CRBG	Columbia River Basalt Group
IBC	International Building Code
FEMA	Federal Emergency Management Agency
OSHA	Occupational Safety and Health Administration
PCA	Power Control Assembly
PGE	Portland General Electric
pcf	pounds per cubic foot
psf	pounds per square foot
SPT	Standard Penetration Test
USCS	Unified Soil Classification System
USGS	United States Geological Survey

# 1 PROJECT UNDERSTANDING

## 1.1 Project Description

We understand PGE is planning the construction of a new 115kV/13kV substation and access road planned in a grass field at approximately 122°46'4.26"W, 45°19'12.15"N, in Wilsonville, Oregon. The proposed substation is approximately 278 feet by 454 feet in size based on conceptual plans included in Appendix A, and involves site grading, an access roadway, standard substation equipment, a control enclosure, and stormwater elements. The dead-end A-frame structures have significantly higher axial loads, including uplift and may require deep foundation support depending on the lateral resistance and uplift capacities of a shallow foundation system. We understand the other equipment such as the circuit breakers and transformers may be placed on concrete pads and the proposed control enclosure is planned to be founded on spread footings. The estimated foundation loads and allowable settlements provided by POWER Engineers are included in Exhibit 1-1 below.

**Exhibit 1-1: Estimated foundation loads and allowable settlement provided by POWER Engineers.**

Structure	Axial (kips)	Uplift (kips)	Shear (kips)	Moment (ft-k)	Foundation Type	Total Allowable Settlement (inch)
Small Equipment	2 - 15	-5	2 - 15	5 - 50	Shallow	0.5 - 1.0
Large Equipment	15 - 50	-15	15 - 50	50 - 300	Shallow	0.5 - 1.0
Control Building	55	—	—	—	Slab	0.5
Transformer	350	—	—	—	Mat	1.0
Deadend Structure	25 - 180	25 - 150	5 - 150	50 - 500	Shallow or Deep	1.0
Transmission Structure	25 - 180	25 - 150	5 - 150	50 - 500	Drilled Pier	1.0

Based on the foundation layout provided to us, the structures are planned to be supported on shallow foundations with the following plan dimensions:

- 115 kv Bus and CVT Supports – 5 ft x 5 ft slab on grade;
- 1-Phase Bus Support – 4 ft x 4 ft slab on grade;
- Breakers – 8 ft x 10 ft mat foundation;
- Transformer – 12 ft x 20 ft mat foundation
- A-Frame Dead-end structures – 10 ft x 24 ft combined footing;
- Control Building – 5 ft x 5 ft spread footings

## 1.2 Site Description

The proposed PGE Memorial Substation is near the north end of the City of Wilsonville, located approximately 8.2 miles southwest of the City of Portland in Clackamas County, Oregon. The project location is shown on the Vicinity Map, Figure 1. The substation site is situated on the east side of Interstate 5 and on the west side of SW Parkway Avenue. The site topography is generally flat with a slight rise in elevation in the middle of the proposed site with slopes on either side of the rise sloping to the south and to the north. There is a 5- to 7-foot-tall approximately 12- to 15-foot wide berm running the length of the west side of the property and heavily overgrown with blackberry brambles, between the property and Interstate 5. Elevations at the site vary between approximately 220 and 227 feet (NAVD88). The site is moderately vegetated with grass with one tall mature Oak tree on the east side of the site near SW Parkway Avenue, and the berm is heavily vegetated with blackberry brambles, low lying shrubs, and moderately forested with a variety of deciduous trees.

Exhibit 1-2 through Exhibit 1-5 present site photographs showing several views of the site and existing features.



**Exhibit 1-2: View of the west side of the site with berm in background from boring B-03.**





**Exhibit 1-3: View of north side of the site from boring B-06.**



**Exhibit 1-4: View of the east and south sides of the site from boring B-03.**



**Exhibit 1-5: View of the northeast corner of the site from the large oak tree along SW Parkway Ave.**

## 1.3 Scope of Services

Our scope of services included the following tasks:

- Performing a surface reconnaissance and desk study of the substation area to evaluate proposed exploration locations and assess geologic hazards;
- Completing a subsurface exploration program including borings, infiltration testing, and laboratory testing;
- Evaluating the proposed substation with general site construction considerations; and
- Developing this geotechnical investigation report.

# 2 GEOLOGY AND SEISMIC SETTING

## 2.1 Regional Geology

The project site is in the Willamette Lowland, at the northern end of the Central Willamette Valley (Gannett and Caldwell, 1998). The Willamette Lowland is a structural depression created by complex faulting and folding of Miocene (about 17 to 6 million years old) Columbia River Basalt Group (CRBG) basalt flows and older underlying basement rock.

In the project area, the CRBG is generally overlain by Upper Miocene (approximately 10- to 5-million-year-old) deposits consisting of fine-grained micaceous fluvial and lacustrine sediments derived from the Columbia and Willamette Rivers that are collectively termed the Sandy River Mudstone (Orr and Orr, 2000). The Sandy River Mudstone is described by Gannett and Caldwell as a micaceous arkosic siltstone, mudstone, and claystone. Overlying the Sandy River Mudstone is the Pliocene (approximately 5 to 2.5 million years old) Troutdale Formation. In the Portland Basin, the Troutdale Formation is generally described as a quartzite-bearing basaltic conglomerate, vitric sandstone, and micaceous sandstone (Gannett and Caldwell, 1998). Composition and thicknesses of both the Sandy River Mudstone and the Troutdale Formation vary with location. In the project area, units assigned to the Troutdale Formation are generally finer grained. Mapping at the project site by Schlicker and Deacon (1967) includes the Sandy River Mudstone with the Troutdale Formation and describes the overall unit as poorly indurated silt, clay, and silty sand with occasional pebble conglomerate beds. The Troutdale Formation is concealed beneath younger sediments and is exposed only in the bottom of steep ravines.

During the late stages of the last great ice age, between about 18,000 and 15,000 years ago, a lobe of the continental ice sheet repeatedly blocked and dammed the Clark Fork River in western Montana, which then formed an immense glacial lake called Lake Missoula. The lake grew until its depth was sufficient to buoyantly lift and rupture the ice dam, which allowed the entire massive lake to empty catastrophically. Once the lake had emptied, the ice sheet again gradually dammed the Clark Fork Valley and the lake refilled, leading to 40 or more repetitive outburst floods at intervals of decades (Allen and others, 2009). These repeated floods are collectively referred to as the Missoula Floods. During each short-lived Missoula Flood episode, floodwaters washed across the Idaho panhandle, through eastern Washington's scablands, and through the Columbia River Gorge. When the floodwater emerged from the western end of the gorge, it spread out over the Portland Basin and pooled to elevations of about 400 feet, depositing a tremendous load of sediment. Boulders, cobbles, and gravel were deposited nearest the mouth of the gorge and along the main channel of the Columbia River. Cobble-gravel bars reached westward across the basin, grading to thick blankets of micaceous sand and silt (Allen and others, 2009). Ma and others (2012) divided the Missoula Flood Deposits at and near the site into two groups:

- Fine-Grained Deposits consisting of sand and silt
- Coarse-Grained Deposits consisting mostly of gravel with cobbles and boulders

The Tonquin Scablands Channels, north of the Wilsonville area, constricted flows from the Missoula Floods, creating a high-energy water surge from the Tualatin Basin in the north emptying into the Central Willamette Valley to the south. The high-velocity water flowing through the gap entrained coarse gravels, cobbles, and boulders that were dropped out of



suspension when the surge lost energy opening up into the Central Willamette Valley near the project site (Thompson, 2015). As a result, much of the Wilsonville area north and south of Boone Bridge is underlain by coarse-grained Missoula Flood Deposits. In more recent times, rivers and streams have deposited alluvial sediments in and along their channels and floodplains (Ma and others, 2012; Smith and Roe, 2015).

## 2.2 Local Geology

Geologic mapping of the proposed substation site by Wells and others (2020) and Schlicker and Deacon (1967) indicate the surface of the site is made up of Missoula Flood Deposits underlain at depth by the Troutdale Formation. Wells and others (2020) describe the Missoula Flood Deposits as Pleistocene age, unconsolidated, stratified clay, silt, sand and gravel deposited primarily by the Missoula Floods. In the northern Willamette Valley, the flood deposits were emplaced over a pre-flood topography of fluvial terraces and valleys achieving a maximum thickness of up to 115 feet. Glacial erratics, or exotic, ice-rafted cobbles and boulders have been deposited by the flood waters around the Willamette Valley, and occasionally are encountered during construction excavations within the Missoula Flood Deposits. In the area of Wilsonville and the proposed substation, the Missoula Flood Deposits are underlain by the Pliocene and Miocene age Troutdale Formation. Schlicker and Deacon (1967) describe the Troutdale Formation in the Wilsonville area as consisting of poorly indurated, gray and brown, silt and clay, and silty fine sand, with occasional pebble conglomerate beds and lenses. They indicate the formation outcrops in patches along the Willamette River from near Newberg to Wilsonville and in adjacent ravines and they also refer to the material as weathered mudstone and sandstone.

## 2.3 Seismic Setting

Oregon is subject to seismic events from three major sources: (1) Cascadia Subduction Zone (CSZ) Megathrust earthquakes at the interface of the Juan de Fuca and North American Plates; (2) deep-focus, CSZ intraplate earthquakes (within the Juan de Fuca and North American Plates); and (3) shallow-focus earthquakes in local and regional continental crustal faults. The maximum magnitude for a CSZ Megathrust event is expected to be in the range of Moment Magnitude (M) 8 to 9, with a possible reoccurrence interval of 500 to 600 years. Intraslab events have occurred on a frequent basis in the Puget Sound area, but there is no strong historical evidence for such events in Oregon and southern Washington.

### 2.3.1 Local Quaternary Faults and Folds

Quaternary faults and folds throughout Oregon and Washington have been located and characterized by the USGS. The USGS provides approximate fault locations and a detailed

summary of available fault information in the USGS Quaternary Fault and Fold Database. The database defines four categories of faults, Class A through D, based on evidence of tectonic movement known or presumed to be associated with large earthquakes during Quaternary time (within the last 2.58 million years). For Class A faults, geologic evidence demonstrates that a tectonic fault exists and that it has likely been active within the Quaternary period. For Class B faults, there is equivocal geologic evidence of Quaternary tectonic deformation, or the fault may not extend deep enough to be considered a source of significant earthquakes. Class C and D faults lack convincing geologic evidence of Quaternary tectonic deformation or have been studied carefully enough to determine that they are not likely to generate significant earthquakes.

According to the USGS Quaternary Fault and Fold Database (USGS, 2022), there are fourteen Class A features and one Class B feature within approximately 30 miles of the project site. Their names, general locations relative to the site, and the time since their most recent deformation are summarized in Exhibit 2-1. The CSZ itself is approximately 130 miles west of the project site, with an average slip rate of approximately 40 millimeters (1.5 inches) per year and the most recent deformation occurring about 300 years ago (Personius and Nelson, 2006).



**Exhibit 2-1: USGS Quaternary Faults or Folds Within an Approximate 30-mile Radius of the Project Site**

Feature Name	Class	USGS Fault Number	Approximate Length	Approximate Distance and Direction from Project Site <sup>1</sup>	Slip Rate Category <sup>2</sup>	Time Since Last Deformation <sup>3</sup>
Canby-Molalla Fault	A	716	31.1 miles	3.9 miles E	< 0.2 mm/yr	< 15 ka
Bolton Fault	B	874	5.6 miles	7.7 miles NE	< 0.2 mm/yr	<1.6 Ma
Newberg Fault	A	717	3.1 miles	9.7 miles W	< 0.2 mm/yr	< 1.6 Ma
Oatfield Fault	A	875	18.0 miles	10.1 miles NE	< 0.2 mm/yr	< 1.6 Ma
Portland Hills Fault	A	877	30.4 miles	10.6 miles NE	< 0.2 mm/yr	<1.6 Ma
Beaverton Fault Zone	A	715	9.3 miles	11.9 miles NNW	< 0.2 mm/yr	< 750 ka
Damascus-Tickle Creek Fault	A	879	9.9 miles	12.9 miles NE	< 0.2 mm/yr	< 750 ka
Mount Angel Fault	A	873	18.6 miles	14.2 miles S	< 0.2 mm/yr	< 15 ka
East Bank Fault	A	876	18.0 miles	15.1 miles NNE	< 0.2 mm/yr	< 750 ka
Grant Butte Fault	A	878	6.2 miles	15.2 miles NE	< 0.2 mm/yr	< 750 ka
Gales Creek Fault Zone	A	718	45.4 miles	15.8 miles WNW	< 0.2 mm/yr	< 1.6 Ma
Helvetia Fault	A	714	4.3 miles	17.4 miles NW	< 0.2 mm/yr	< 1.6 Ma
Lacamas Lake Fault	A	880	14.9 miles	26.5 miles NE	< 0.2 mm/yr	< 750 ka
Waldo Hills Fault	A	872	7.5 miles	27.9 miles S	< 0.2 mm/yr	< 1.6 Ma
Salem-Eoloa Hills homocline	A	719	19.9 miles	29.3 miles SW	< 0.2 mm/yr	< 1.6 Ma

## NOTES:

- 1 Approximate distance between project site and nearest extent of fault mapped at the ground surface.
- 2 mm = millimeters; yr = year.
- 3 Ma = "Mega-annum" or million years ago; ka = "Kilo-annum" or one thousand years ago.

## 3 EXPLORATION PROGRAM

### 3.1 Field Explorations

Shannon & Wilson explored subsurface conditions at the site with six geotechnical borings, designated B-01 through B-06, and one infiltration test, designated INF-01. The geotechnical borings were completed between August 22<sup>nd</sup> and August 24<sup>th</sup>, 2022, by a CME-75 truck mounted drill rig provided and operated by Western States Soil Conservation, Inc., out of Hubbard, Oregon. The borings were advanced to depths ranging from 31 to 101.5 feet below ground surface (bgs) using hollow stem auger drilling technique in boring B-01, and open-hole mud rotary drilling technique in borings B-02 through B-06. The approximate exploration locations are shown on Figure 2, Site and Exploration Plan.

A qualified Shannon & Wilson geologist was on site throughout our exploration program to locate the borings, observe the drilling, collect samples, and log the materials encountered. Details of the exploration program, including descriptions of the techniques used to advance and sample the borings, logs of the materials encountered, and backfill details are presented in Appendix B, Field Explorations.

### 3.2 In-Situ Infiltration Testing

An in-situ infiltration test, with the designation INF-01, was completed at one location specified by POWER Engineers in an emailed Google Earth kmz file received by Shannon & Wilson on June 27, 2022, and at the approximate location shown on Figure 2. The test was performed to determine a representative infiltration rate of water into the onsite soils. The test was performed in accordance with the Standard Test Method for Infiltration Rate of Soils in Field Using Double-Ring Infiltrometer per ASTM D3385-18. Details about the infiltration testing and test results are presented in Appendix B.

### 3.3 Geotechnical Laboratory Testing

The samples we obtained during our field explorations were transported to our laboratory for further observation. We then selected representative samples for geotechnical laboratory tests. The geotechnical laboratory testing program included moisture content tests and Atterberg limits tests. Testing was performed by GeoTesting Express, Inc. of Acton, Massachusetts. All tests were performed in accordance with applicable American Society for Testing and Materials (ASTM) International standards. The results of the laboratory tests and brief descriptions of the test procedures are presented in Appendix C, Laboratory Test Results.

### 3.4 Thermal Resistivity Testing

Relatively undisturbed samples were collected in each boring for thermal resistivity testing. As specified by Kevin Vo with Portland General Electric in an email received August 22, 2022, we collected samples for thermal resistivity testing in each of the borings at a depth of 5 feet. The samples were recovered using thin-walled tube sampling in accordance with ASTM D1587. The samples were tested by Geotherm USA of Cypress, Texas. The results of thermal resistivity testing are presented in Appendix C, Laboratory Test Results.

## 4 SUMMARY OF SUBSURFACE CONDITIONS

The explorations and laboratory testing were performed to evaluate geotechnical soil and groundwater conditions for the PGE Memorial Substation Project. This section describes the general geotechnical units encountered in our subsurface exploration program and includes an overview of our interpreted geologic conditions at the project site.

Our observations presented in this report are specific to the locations, depths, and times noted on the logs and may not be applicable to all areas of the site. No amount of explorations or testing can precisely predict the characteristics, quality, or distribution of subsurface and site conditions. Potential variation includes, but is not limited to, the following:

- The conditions between and below explorations may be different.
- The passage of time or intervening causes (natural and manmade) may result in changes to site and subsurface conditions.
- Groundwater levels and flow directions may fluctuate due to seasonal, irrigation-related, and recharge source variations.

If conditions different from those described herein are encountered during construction, we should review our description of the subsurface conditions and reconsider our conclusions and recommendations.

### 4.1 Geotechnical Units

We grouped the materials encountered in our field explorations into three geotechnical units, as described below. Our interpretation of the subsurface conditions is based on the explorations and regional geologic information from published sources described herein and in Appendix B. General descriptions of the geotechnical units encountered in our subsurface explorations are as follows:

- **Fill:** medium stiff to hard, Lean Clay, Lean Clay with Sand, Lean Clay with Gravel (CL); and very stiff, Fat Clay with Sand (CH).
- **Missoula Flood Deposits:** soft to stiff, Lean Clay and Lean Clay with Sand (CL); soft to very stiff, Silt, and Silt with Sand to Sandy Silt (ML); soft to medium stiff, Elastic Silt (MH); very loose, Clayey Sand (SC); and medium stiff, Fat Clay (CH).
- **Troutdale Formation:** medium stiff to very stiff, Fat Clay (CH).

These geotechnical units were grouped based on their engineering properties, geologic origins, and their distribution in the subsurface. Contacts between units may be more gradational than shown on the Logs of Borings in Appendix B. The Standard Penetration

Test (SPT) blow counts shown on the Logs of Borings, and discussed below, are as counted in the field (uncorrected). The following sections provide additional details for each of the individual geotechnical units listed previously.

#### 4.1.1 Fill

Fill represents soil placed by humans during development of industry, transportation, and housing. This Fill material can often be highly irregular, containing cobbles, boulders, fragments of concrete, asphalt, and logs and other organics. We consider the Fill material to be undocumented since we have no information concerning materials or compaction and consider the material to be highly irregular and may contain pockets or locations of very soft material or material which may create settlement issues. Fill was encountered at the surface in all borings performed for the substation, and the Fill extended to depths ranging from 4.5 to 8.5 feet below ground surface (bgs). The Fill appeared thinnest in borings B-03 and B-05 where it was 4.5 feet thick, and the deepest portion of Fill was encountered in borings B-04 and B-06 which had a Fill thickness of 8.5 and 7.5 feet, respectively. The Fill material encountered in the borings generally consists of medium stiff to hard, gray, red-brown, black and brown mottled Lean Clay, Lean Clay with Sand, and Lean Clay with Gravel (CL) and very stiff, gray Fat Clay with Sand (CH). The sand constituent is generally fine to coarse, and the material often contains trace amounts of fine to coarse, subangular to rounded gravel. The soil is generally medium to high plasticity and contains occasional cobbles. A disturbed texture was observed in many samples and the Fill is occasionally slightly iron oxidized or iron oxide stained. One of the eight SPTs attempted in the Fill met refusal, where more than 50 blows were required to drive the sampler through a 6-inch interval. Non-refusal SPT N-values in the Fill ranged from 7 to 14 blows per foot (bpf) and averaged 12 bpf.

#### 4.1.2 Missoula Flood Deposits

The Missoula Flood Deposits represent sediments deposited by the catastrophic Missoula Floods. The Missoula Flood Deposits were encountered in the borings underlying the Fill and extended to depths ranging from 22.5 to 32 feet bgs. The thickness of the Missoula Flood Deposits unit ranged from 16 to 23.5 feet. The Missoula Flood Deposits generally consist of soft to stiff, brown to gray and dark gray Lean Clay and Lean Clay with Sand (CL); soft to very stiff, red-brown, blue-gray, and gray Silt, and Silt with Sand to Sandy Silt (ML); soft to medium stiff, brown and blue-gray Elastic Silt (MH); medium stiff, blue-gray to brown Fat Clay (CH); and very loose, brown Clayey Sand (SC). If sand was encountered in the material, it was generally fine to medium grained. Occasionally, trace amounts of fine, angular to subrounded gravel was encountered within the unit. Although not encountered within the borings performed for the proposed substation, glacial erratics, or exotic, ice-

rafted cobbles and boulders have been deposited by the flood waters around the Willamette Valley and occasionally are encountered within the Missoula Flood Deposits unit.

SPT N-values in the Missoula Flood Deposits ranged from 2 to 14 bpf and averaged 7 bpf. Moisture contents of a tested samples ranged from 29 to 54 percent and averaged 39 percent. Atterberg limits tests on seven samples indicated five samples with material passing the #40 sieve with plasticity indexes ranging from 8 to 12, with a USCS group designation of ML, and two samples with material passing the #40 sieve with plasticity indexes of 8 and 17, with a USCS group designation of MH.

#### 4.1.3 Troutdale Formation

The Troutdale Formation was encountered underlying the Missoula Flood Deposits in all six borings performed for the proposed substation at depths ranging from 22.5 to 32 feet. None of the six borings penetrated the base of the unit, and all six borings were terminated within the unit at depths ranging from 31 to 101.5 feet bgs. The Troutdale Formation encountered in the borings consists of medium stiff to very stiff, gray, red-brown, gray-brown, blue-gray, orange and brown mottled, Fat Clay (CH). The material is generally high plasticity and occasional samples contained trace amounts of fine to coarse sand. Samples of the Troutdale Formation often exhibit slight to heavy iron oxide staining and occasionally contain fine to coarse sand sized iron oxide nodules or deposits. Some samples were stratified with 2- to 4-inch thick interbeds of Fat Clay with Sand. SPT N-values in the Missoula Flood Deposits ranged from 2 to 25 bpf and averaged 13 bpf.

## 4.2 Groundwater

Hollow-stem auger drilling technique was used on boring B-01, which was the first boring completed at the project site to allow an observation of groundwater during the explorations. Boring B-01 was advanced to a depth of 51.5 feet below ground surface and the augers were left in the ground from August 22<sup>nd</sup> until the afternoon of August 24<sup>th</sup> to allow groundwater in the augers to equilibrate and a groundwater measurement to be made prior to removal of the augers. Groundwater was measured during drilling of boring B-01 on August 22<sup>nd</sup> at a depth of 15.34 feet. On August 24<sup>th</sup> groundwater in the hollow-stem augers was measured at a depth of 20.4 feet. Borings B-02 through B-06 were drilled using open-hole mud rotary drilling technique, which introduces drilling fluids into the borehole which results in an indeterminable water level.

Loss of drilling fluids, and drilling fluid circulation loss in the boreholes was not encountered during drilling. Drilling fluid loss and loss of fluid circulation may indicate an open-matrix gravel containing limited matrix material, or voids. During drilling and during the water depth measurement in boring B-01, artesian conditions were not observed.



Well logs published by the Oregon Water Resources Department Well Report Mapping Tool (OWRD, 2022) indicate groundwater in water wells within approximately 0.5 miles of the site indicate groundwater at depths ranging from 55 to 106 feet below ground surface. Information from the well logs is presented in Exhibit 4-1.

**Exhibit 4-1: Well Log information compiled from the Oregon Water Resources Department**

Well ID	Distance from Project Site (miles)	Static Water Level Below Surface (ft)
CLAC0050585	0.18 miles SE	97
CLAC0051707	0.18 miles SE	106
CLAC0008035	0.34 miles NW	55
CLAC0008034	0.5 miles N	56

We assume perched groundwater locally tends to occur at the top of the Troutdale Formation or within the Missoula Flood Deposits. Based on measurements in boring B-01 we assume groundwater at the site varies from 15 to 20 feet below ground surface. Groundwater at the site will generally vary based on precipitation and local irrigation for landscaping. We expect groundwater levels throughout the site should be expected to vary seasonally and with changes in topography and precipitation. Locally, groundwater highs typically occur in the late fall to spring and groundwater lows typically occur in the late summer and early fall.

## 5 GEOLOGIC AND SEISMIC HAZARDS

Shannon & Wilson reviewed publicly available geologic and technical publications along with data collected from the site reconnaissance and subsurface explorations to assess the landslide, flooding, and seismic (including liquefaction) hazards at the site. The following paragraphs discuss these hazards in greater detail.

These assessments are summaries of the potential geologic hazards at the site and are not meant to fully characterize each hazard. Further research, explorations, and analysis may be necessary to properly characterize the hazard and its impact on the substation.

### 5.1 Landslide Hazard

There are no mapped landslides upslope or near the proposed substation site. According to the Oregon Department of Geology and Mineral Industries Statewide Geohazards Viewer (DOGAMI, 2020), landslide hazard is generally low with landsliding unlikely for the site. However, the area of the berm along the west side of the site and the cut slope between the site and Interstate 5 are mapped as moderate with landsliding possible. Given the height

and incline of the slope, if substation equipment structures are set back a minimum 30 feet from the top of the slope it is our opinion the landslide hazard risk at the site is low.

## 5.2 Flooding Hazard

The project site is located in a broad flat area approximately 90 feet in elevation above the Boeckman Creek drainage, which is approximately 0.56 miles east of the site, and approximately 70 feet in elevation above the Tapman Creek drainage and Coffee Lake Creek drainages approximately 0.6 miles west of the site. The proposed substation site is at an approximate elevation 220 (NAVD88) and the Willamette River floodplain is approximately 1.4 miles south of the site and is at an approximate elevation of 95 feet. The proposed substation site is located outside the 100-year flood (1% annual chance of flooding) extent, according to Federal Emergency Management Agency (FEMA, 2008) National Flood Insurance Program Flood Insurance Rate Maps (FIRM) and in a FEMA Flood Zone X area determined to be outside the 0.2% annual chance floodplain.

## 5.3 Seismic Design Parameters

For the proposed substation, we obtained seismic design parameters from the 2018 International Building Code (IBC) and subsequently the 2016 edition of ASCE 7 (ASCE 7-16). The maximum considered earthquake (MCE) ground motions for the new structure are obtained from the USGS's US Seismic Design Maps Web Application, which considers a target risk of structural collapse of 1 percent in 50 years (USGS, 2022). Exhibit 5-1 provides the recommended seismic design parameters for the site.

**Exhibit 5-1: Recommended Seismic Design Parameters**

Parameter	Symbol	ASCE 7-16
Site Class	-	E
Mapped Zero Period Spectral Acceleration	PGA	0.374g
Mapped Short Period Spectral Acceleration	S <sub>s</sub>	0.82g
Mapped 1-Second Period Spectral Acceleration	S <sub>1</sub>	0.382g
Zero Period Site Factor	F <sub>PGA</sub>	1.453
Short Period Site Factor	F <sub>a</sub>	1.300
1-Second Period Site Factor	F <sub>v</sub>	2.472*
Site Adjusted Zero Period Spectral Acceleration	PGA <sub>M</sub>	0.543g
Site Adjusted Short Period Spectral Acceleration	S <sub>MS</sub>	1.067g
Site Adjusted 1-Second Period Spectral Acceleration	S <sub>M1</sub>	0.944*
Short Period Design Spectral Acceleration	S <sub>DS</sub>	0.711g
1-Second Period Design Spectral Acceleration	S <sub>D1</sub>	0.630*

\*Per ASCE 7-16 Supplement 1, value can only be used to calculate T<sub>s</sub>.

ASCE 7-16 Section 11.4.8 requires structures on Site Class E site with S<sub>1</sub> greater than or equal to 0.2g to have a ground motion hazard analysis performed in accordance with Chapter 21. However, ASCE 7-16 also provides an exception in Section 11.4.8 stating that a ground motion hazard analysis is not required provided the fundamental period (T) is less than or equal to T<sub>s</sub> (T<sub>s</sub> = S<sub>D1</sub>/S<sub>DS</sub>) and the equivalent static force procedure is used for design.

## 5.4 Seismic Hazards

### 5.4.1 Liquefaction

Liquefaction is a phenomenon in which excess pore water pressure in loose to medium dense, saturated, nonplastic to low plasticity silts and granular soils develops during ground shaking. The increase in excess pore pressure may result in a reduction of soil shear strength and a quicksand-like condition.

Important factors in evaluating a soil's susceptibility to liquefaction include relative density, the fines content (percent of soil by weight smaller than 0.075 millimeter, passing the U.S. No. 200 sieve), and the plasticity characteristics of the fines. Relative density can be estimated from SPT N-values that were performed for this project. We performed laboratory Atterberg limits testing to evaluate the plasticity of the site soils.

We conducted a screening for liquefiable soils based on the Boulanger and Idriss (2006) method which recommends that fine-grained soils with a plasticity index (PI) less than 7 are



susceptible to liquefaction. Based on review of the explorations and laboratory testing, our screening indicates that the silt to silty sand deposits below the groundwater generally have PI's that are greater than 7 and are therefore not susceptible based on the criteria.

However, one Atterberg limit test performed on boring B-3 at a depth of 15 feet resulted in a PI equal to 6. Based on a groundwater reading at boring B-1, the groundwater elevation is approximately 208 feet. The bottom of the potentially liquefiable layer at boring B-3 is at an approximate elevation of 207 feet. Therefore, the potential for liquefaction induced settlements are anticipated to be less than 0.5 inches.

#### 5.4.2 Fault Rupture

As shown in Exhibit 2-1, the closest active mapped fault to the site is the Canby-Molalla Fault, located approximately 3.9 miles to the east of the project site. In our opinion, given the distance between the site and the fault, the potential for a hazard posed by ground surface fault rupture at the site is low.

#### 5.4.3 Slope Instability

According to DOGAMI, the site has zones of moderate landslide hazard along the western boundary of the site. There are no mapped active or historic landslides within the site limits documented in the DOGAMI GeoHazard database. We did not observe evidence of slope instability at the site during our site reconnaissance or explorations, nor did we observe evidence of offsite slope instability that could pose a risk to the proposed substation. In our opinion, the hazard potential for slope instability at the substation site is low.

## 6 GEOTECHNICAL DESIGN RECOMMENDATIONS

### 6.1 General

Geotechnical design recommendations are based on our field explorations, laboratory test results, and our understanding of the project based on current design information provided by POWER Engineers, Inc. Geotechnical design recommendations for the proposed structures are provided in the following sections. If structure or foundation types and configurations change after this report, Shannon & Wilson should be contacted to provide updated recommendations.

Based on information from POWER Engineers we understand that small and large equipment, as well as the control building, will be supported on shallow spread footings, and transformers will be constructed using mat foundations. Dead-end structures may be supported on either shallow or deep foundations depending on the lateral resistance

capacity of the shallow foundations. We understand that transmission structures are not planned to be constructed within the substation. Discussions and recommendations pertaining to shallow and deep foundations are presented in the following sections.

## 6.2 Shallow Foundations

Based on the equipment schedule presented in Exhibit 1-1, we understand that large and small equipment such as circuit breakers and the control house will be placed on shallow foundations. Structures that are supported on a continuous, structurally connected foundation system may be supported on 12 inches of crushed rock overlying, firm undisturbed soils. We recommend that foundations have a minimum width of 24 inches and a minimum embedment of 18-inches.

For structures (i.e. the control building) where columns are supported on isolated spread footings that are not structurally connected, we recommend over excavating undocumented fill due to the potential for differential settlement between the individually loaded footings. For the case of structures supported on individually loaded footings that are not structurally connected, spread footings should be supported on compacted crushed rock bearing on firm native soils, where the presence of native soils is confirmed by a qualified geotechnical engineer.

### 6.2.1 Bearing Capacity

Spread foundations and mat foundations built over a properly constructed minimum 12-inch-thick crushed rock pad can be designed for a maximum allowable soil-bearing pressure of 2,000 pounds per square foot (psf). These values apply to the total dead load and can be increased by one-third for wind or seismic loading. This bearing capacity is based on a minimum footing width of 2 feet and minimum embedment depth of 12 inches for columns and a minimum width of 18 inches for continuous perimeter footings. Based on Exhibit 1-1, the shallow foundations are expected to have unbalanced loads due to the shear and moments indicated in the table and will therefore have a non-uniform pressure distribution. Therefore, the bearing capacity provided is representative of the maximum capacity corresponding to the non-uniform pressure distribution.

### 6.2.2 Settlement

For footings and mat foundations constructed as described above, we estimate a maximum total settlement of less than 1 inch under static loading conditions for lightly loaded structures. Settlement for heavily loaded structures (i.e. the transformers) could be slightly greater than 1 inch due to very soft to soft soil conditions at a depth of 15-20 feet. One consideration to mitigate the potential impact of settlement is to allow any settlement to

occur prior to making any rigid connections. The very soft to soft soil layer that is present at a depth of 15 to 20 feet is above the groundwater table and is relatively low plasticity and sandy. Therefore, we anticipate that settlements within this zone will occur relatively quickly. We would recommend that rigid connections to the heavily loaded structures be delayed by one week to allow time for any settlements to occur. Differential settlement between adjacent footings is typically 50 percent of the estimated total settlement when subgrade conditions are relatively uniform. Our settlement estimate assumes that no disturbance to the foundation soil subgrade will be permitted during excavation and that the subgrade will be properly prepared.

### 6.2.3 Uplift Resistance

Uplift resistance of shallow foundations should be estimated based on the dead weight of the structure and the dead weight of the backfill material placed over the foundation. For estimating the uplift resistance, we recommend that a unit weight of 120 pounds per cubic foot (pcf) be used assuming that the backfill is imported crushed rock discussed in Section 7.1. If necessary, tiedown anchors can be installed to provide additional uplift resistance to shallow foundations.

### 6.2.4 Lateral Resistance

The soil resistance available to withstand lateral foundation loads is a function of the frictional resistance, which can develop on the base of the foundation, and the partial soil passive resistance, which is assumed to be about 50 percent of full soil passive resistance. We recommend that an allowable partial soil passive pressure,  $180D$  psf (where  $D$  is depth of the embedment of the bottom of foundation), be used for design of sliding and overturning resistance. The allowable frictional resistance may be computed using a coefficient of friction of 0.4. The top 12 inches of soil should not be used in calculating passive resistance, as construction and post-construction activities often disturb this upper material. Typically, the lateral resistance of shallow foundations is by a combination of passive resistance along the buried portions of the foundation and sliding resistance along the base of the foundation.

## 6.3 Deep Foundations

We understand that the proposed dead-end structures may need to be founded on deep foundations depending on the lateral resistance capacities of a shallow foundation system. Typical deep foundations that have been used to support these structures are drilled shaft / drilled pier foundations. In the following sections, we have provided discussions related to axial and lateral capacities for drilled shaft foundations.

### 6.3.1 Axial Resistance

Axial resistance of the proposed drilled shaft can be evaluated based on the axial resistance parameters presented in Table 2. For each layer, we estimated the ultimate end bearing. Most of the soils encountered in our explorations consisted of fine-grained material. Therefore, an ultimate unit skin friction is provided for these layers. However, a few explorations encountered sandier soils and therefore to evaluate skin friction for these layers we provided  $k \cdot \tan(\delta)$  values, which are commonly referred to as  $\beta$  values. To calculate an ultimate unit skin friction, the  $k \cdot \tan(\delta)$  values are to be multiplied by the vertical effective stress. For calculation of allowable axial capacity, we recommend a Factor of Safety of 3 be applied to these ultimate axial capacity parameters.

### 6.3.2 Lateral Resistance Parameters

Drilled shaft foundations will be subjected to lateral loads resulting from static and seismic loading. To analyze the lateral resistance, we have provided the Foundation Analysis and Design (FAD) parameters in Table 1 and LPile Parameters in Table 2.

## 7 CONSTRUCTION CONSIDERATIONS

### 7.1 Site Preparation and Earthwork

#### 7.1.1 Stripping and Grubbing

Organic material and topsoil should be stripped and removed from all proposed structures and pavement areas. Based on our explorations, we anticipate a stripping depth of approximately 3 to 6 inches. Greater depths may be necessary to remove localized zones of organic material. Stripped material should be transported off-site for disposal or used as fill-in landscaping areas.

#### 7.1.2 Reuse of On-site Material

The shallow near surface soils are primarily fine-grained silts and clays that will be moisture sensitive and difficult to place and compact particularly during periods of wet weather. The existing soils are likely wet of optimum and will require drying in order to achieve the required compaction requirements. We do not recommend reusing the existing fill and native soils as structural fill except in periods of extended dry weather when the material can be farmed and disced and when full time construction observations are performed to confirm the soil has been compacted to 92 percent of the maximum density and within 2 percent of optimum as determined by ASTM D1557. The fill should be placed in 6-inch loose lifts and compacted to a firm and unyielding condition. Additionally, the fill should

be screened to remove any organics, deleterious material, or particles greater than 2 inches before reuse as structural fill.

If there is risk that the work cannot be done during a period of extended dry weather when the soil cannot be farmed and dried to optimum moisture content, or that full-time observations may not occur, we do not recommend the use of reworked native soil as structural fill under buildings or other settlement sensitive structures. Additionally, the reworked structural fill should not be used as a substitute for the 12-inch-thick crushed rock pad directly beneath the foundations described in Section 6.2, which is still required. The existing fill and native soils removed for substation grading or footing excavations can also be used for back fill in locations receiving landscaping.

### 7.1.3 Foundation Subgrade Preparation

All footing subgrades should be trimmed neatly and carefully prepared. We recommend that the footing excavations be observed by the Geotechnical Engineer of Record or their representatives to verify that the recommendations of this report have been followed and that conditions encountered are as anticipated.

The relative density of the subgrade should be observed, and any disturbed, soft, deleterious, or unsuitable materials should be removed and replaced with imported crushed rock fill material or on-site material prepared in accordance with the recommendations in the previous Section 7.1.2. We recommend a contingency be placed in the budget for over-excavation of footing, floor slab, and mat subgrade. Undocumented fill should be removed from beneath all isolated spread footings. Over-excavation should be performed beyond the proposed foundation limits so that the zone that is within a 1H:1V line extending from the exterior of the foundation is encompassed and backfilled with crushed rock.

Once neat excavation is complete and the subgrade has been observed and approved by the representative of the geotechnical engineer, the placement of the crushed rock fill material should happen immediately. We also recommend that a non-woven separation geotextile with properties similar to the properties provided in Table 02320-4, Section 02320.20 of the Oregon Standard Specifications for Construction, such as a Mirafi 140N be placed between the subgrade and the crushed rock fill.

Imported crushed rock beneath structures should consist of  $\frac{3}{4}$ -inch minus well-graded crushed rock, with less than 5 percent passing the No. 200 sieve. Crushed rock beneath structures should be placed and compacted to 95 percent of the maximum dry density as determined by ASTM D 1557 (Modified Proctor) on the prepared subgrade.



## 7.2 Wet Weather Earthwork

The soil at the site contains silts and fines that may produce an unstable mixture when exposed to moisture. Such soils are susceptible to changes in water content, and they tend to become unstable and difficult or impossible to compact if their moisture content significantly exceeds the optimum. If wet conditions are encountered, we recommend the following:

- The ground surface in and surrounding the construction area should be sloped as much as possible to promote runoff of precipitation away from work areas and to prevent ponding of water.
- Earthwork should be accomplished in small sections to minimize exposure to wet conditions. That is, each section should be small enough so that the removal of unsuitable soils and placement and compaction of fill materials can be accomplished on the same day.
- Any accidental overexcavation should be filled with crushed rock.
- The size of construction equipment may have to be limited to prevent soil disturbance. It may be necessary to excavate soils with a backhoe or equivalent, located so that equipment does not traffic over the excavated area. Thus, subgrade disturbance caused by equipment traffic will be minimized.
- No soil should be left uncompacted and exposed to moisture. A smooth-drum roller or equivalent should roll the surface to seal out as much water as possible.
- In-place soils or fill soils that become wet and unstable and/or too wet to suitably compact should be removed and replaced with crushed rock.
- Grading and earthwork should not be performed during periods of heavy, continuous rainfall.

We suggest that these recommendations for wet weather earthwork be included in the contract specifications.

## 7.3 Drilled Shaft Construction Considerations

### 7.3.1 General

The drilled shaft installation procedures should follow the PGE Specifications for drilled shafts, combined with project-specific provisions that may apply. The selection of equipment and procedures for constructing drilled shafts should consider shaft diameter and length, as well as subsurface conditions. The design and performance of drilled shafts can be significantly influenced by the equipment and construction procedures used to install the shafts.

Generally, the drilled shafts are constructed by excavating a cylindrical bore to the prescribed embedment with a large-diameter auger or other drilling tool. Temporary or permanent casing is often used, depending on site conditions. Upon completion of drilling and inspection of the shaft, a steel rebar cage is placed, and concrete is pumped into the hole to complete the drilled shaft. If caving or instability of the drilled shafts is observed during drilling, we recommend that the drilled shafts be constructed using fully-cased excavations down to the design tip elevation. The drilled shafts should be constructed in the wet, and the casing should be advanced ahead of the auger.

### 7.3.2 Drilled Shaft Quality Control

We recommend that an experienced and qualified geotechnical engineer familiar with the subsurface conditions of the project site observe drilled shaft construction. This engineer should visually evaluate soil removed from the excavation or retrieved from the auger flights and cleanout buckets. These observations would confirm that the subsurface conditions assumed for design are present. This engineer must also observe and evaluate the base of the excavated shaft to determine that the base cleanout conforms to project special provisions.

To aid in quality control of the drilled shafts, the project team may consider crosshole sonic logging (CSL) to evaluate concrete integrity. The integrity tests should be performed and analyzed by experienced and qualified personnel. If voids, low-velocity (strength) zones, or other abnormalities/defects are detected in the CSL testing, the test findings should be analyzed to determine if the installed drilled shafts satisfy the design requirements or if mitigation and/or additional CSL tests are required.

## 8 ADDITIONAL SERVICES

We recommend that Shannon & Wilson be retained to observe the geotechnical aspects of construction, particularly foundation subgrades. Observation will allow us to evaluate the subsurface conditions as they are exposed during construction and to determine that the work is accomplished in accordance with our recommendations and the intent of the project specifications.

## 9 LIMITATIONS

The data collection, analyses, conclusions, and recommendations contained in this report are based on site conditions as they presently exist, and further assume that the explorations are representative of the subsurface conditions throughout the site; that is, the subsurface

conditions everywhere are not significantly different from those disclosed by the explorations. If subsurface conditions different from those encountered in the explorations are encountered or appear to be present during construction, we should be advised at once so that we can review these conditions and reconsider our recommendations, where necessary. If there is a substantial lapse of time between the submission of this report and the start of construction at the site, or if conditions have changed because of natural forces or construction operations at or adjacent to the site, we recommend that we review our report to determine the applicability of the conclusions and recommendations.

Within the limitations of scope, schedule, and budget, the analyses, conclusions, and recommendations presented in this report were prepared in accordance with generally accepted professional geotechnical engineering principles and practice at the time this report was prepared. We make no other warranty, either express or implied. These conclusions and recommendations were based on our understanding of the project as described in this report and the site conditions as observed at the time of our explorations.

Unanticipated soil conditions are commonly encountered and cannot be fully determined by merely taking soil samples from geotechnical borings. Such unexpected conditions frequently require that additional expenditures be made to attain a properly constructed project. Therefore, some contingency fund is recommended to accommodate such potential extra costs.

This report was prepared for the exclusive use of POWER Engineers and PGE. The data and report should be provided to the contractors for their information, but our report, conclusions, and interpretations should not be construed as a warranty of subsurface conditions included in this report.

The scope of our present work did not include environmental assessments or evaluations regarding the presence or absence of wetlands, or hazardous or toxic substances in the soil, surface water, groundwater, or air, on or below or around this site, or for the evaluation or disposal of contaminated soils or groundwater should any be encountered.

Please read the Important Information section at the back of this report to reduce your project risks.



## 10 REFERENCES

- Allen, J.E., Burns, M., and Burns, S., 2009, *Cataclysms on the Columbia: The Great Missoula Floods* (2nd ed.): Portland, Oregon, Ooligan Press, 204 p.
- American Society of Civil Engineers, 2017, *Minimum design loads and associated criteria for buildings and other structures*: Reston, Va. American Society of Civil Engineers, ASCE Standard ASCE/SEI 7-16, 2 v.
- Boulanger, R., and Idriss, I.M., 2006, *Liquefaction Susceptibility Criteria for Silts and Clays*, *Journal of Geotechnical and Geoenvironmental Engineering*, Vol. 132, Issue 11.
- Federal Emergency Management Agency (FEMA), 2008, *Clackamas County, Oregon and Incorporated Areas: National Flood Insurance Program Flood Insurance Rate Map Panel 234D of 1175, scale 1:500*.
- Gannett, G.W. and Caldwell, R.R., 1998; *Geologic Framework of the Willamette Lowland Aquifer System, Oregon and Washington*: U.S. Geological Survey Professional Paper 1424-A, 32 p., 8 pls.
- Ma, Lina, Madin, I.P., Duplantis, S., and Williams, K.J., 2012, *Lidar-Based Surficial Geologic Map of the Greater Portland Area: Clackamas, Columbia, Marion, Multnomah, Washington, and Yamhill Counties, Oregon and Clark County, Washington*: Oregon Department of Geology and Mineral Industries, Open-File Report O-12-02, scale 1:63,360.
- Oregon Department of Geology and Mineral Industries (DOGAMI), 2020, *Statewide Geohazards Viewer website*, <https://www.oregongeology.org/hazvu/index.htm>, accessed 09/14/2022.
- Oregon Water Resources Department (OWRD), 2022, *Oregon Water Resources Department Well Report Mapping Tool website*, [https://apps.wrd.state.or.us/apps/gw/wl\\_well\\_report\\_map/Default.aspx](https://apps.wrd.state.or.us/apps/gw/wl_well_report_map/Default.aspx)
- Orr, Elizabeth L. and Orr, William N., 2000, *Geology of Oregon: Fifth Edition*: Dubuque, Iowa, Kendall/Hunt.
- Personius, S.F., compiler, 2002, *Fault number 714, Helvetia fault*, in *Quaternary fault and fold database of the United States*: U.S. Geological Survey website, <https://earthquakes.usgs.gov/hazards/qfaults>, accessed 09/14/2022 01:13 PM.
- Personius, S.F., compiler, 2002, *Fault number 715, Beaverton fault zone*, in *Quaternary fault and fold database of the United States*: U.S. Geological Survey website, <http://earthquakes.usgs.gov/hazards/qfaults>, accessed 09/14/2022 12:49 PM.

- Personius, S.F., compiler, 2002, Fault number 716, Canby-Molalla fault, in Quaternary fault and fold database of the United States: U.S. Geological Survey website, <https://earthquakes.usgs.gov/hazards/qfaults>, accessed 09/14/2022 12:33 PM.
- Personius, S.F., compiler, 2002, Fault number 717, Newberg fault, in Quaternary fault and fold database of the United States: U.S. Geological Survey website, <http://earthquakes.usgs.gov/hazards/qfaults>, accessed 09/14/2022 12:44 PM.
- Personius, S.F., compiler, 2002, Fault number 718, Gales Creek fault zone, in Quaternary fault and fold database of the United States: U.S. Geological Survey website, <http://earthquakes.usgs.gov/hazards/qfaults>, accessed 09/14/2022 12:50 PM.
- Personius, S.F., compiler, 2002, Fault number 719, Salem-Eola Hills homocline, in Quaternary fault and fold database of the United States: U.S. Geological Survey website, <https://earthquakes.usgs.gov/hazards/qfaults>, accessed 09/14/2022 01:05 PM.
- Personius, S.F., compiler, 2002, Fault number 872, Waldo Hills fault, in Quaternary fault and fold database of the United States: U.S. Geological Survey website, <https://earthquakes.usgs.gov/hazards/qfaults>, accessed 09/14/2022 01:08 PM.
- Personius, S.F., compiler, 2002, Fault number 874, Bolton fault, in Quaternary fault and fold database of the United States: U.S. Geological Survey website, <https://earthquakes.usgs.gov/hazards/qfaults>, accessed 09/14/2022 12:38 PM.
- Personius, S.F., compiler, 2002, Fault number 875, Oatfield fault, in Quaternary fault and fold database of the United States: U.S. Geological Survey website, <https://earthquakes.usgs.gov/hazards/qfaults>, accessed 09/14/2022 12:47 PM.
- Personius, S.F., compiler, 2002, Fault number 876, East Bank fault, in Quaternary fault and fold database of the United States: U.S. Geological Survey website, <https://earthquakes.usgs.gov/hazards/qfaults>, accessed 09/14/2022 01:05 PM.
- Personius, S.F., and Haller, K.M., compilers, 2017, Fault number 877, Portland Hills fault, in Quaternary fault and fold database of the United States: U.S. Geological Survey website, <https://earthquakes.usgs.gov/hazards/qfaults>, accessed 09/14/2022 12:59 PM.
- Personius, S.F., compiler, 2002, Fault number 880, Lacamas Lake fault, in Quaternary fault and fold database of the United States: U.S. Geological Survey website, <https://earthquakes.usgs.gov/hazards/qfaults>, accessed 09/14/2022 01:02 PM.

- Personius, S.F., Lidke, D.J., and Haller, K.M., compilers, 2014, Fault number 873, Mount Angel fault, in Quaternary fault and fold database of the United States: U.S. Geological Survey website, <https://earthquakes.usgs.gov/hazards/qfaults>, accessed 09/14/2022 12:57 PM.
- Personius, S.F., compiler, 2002, Fault number 878, Grant Butte fault, in Quaternary fault and fold database of the United States: U.S. Geological Survey website, <http://earthquakes.usgs.gov/hazards/qfaults>, accessed 09/14/2022 01:08 PM.
- Personius, S.F., compiler, 2002, Fault number 879, Damascus-Tickle Creek fault zone, in Quaternary fault and fold database of the United States: U.S. Geological Survey website, <http://earthquakes.usgs.gov/hazards/qfaults>, accessed 09/14/2022 12:52 PM.
- Personius, S.F., and Nelson, A.R., compilers, 2006, Fault number 781, Cascadia megathrust, in Quaternary fault and fold database of the United States: U.S. Geological Survey website, <https://earthquakes.usgs.gov/hazards/qfaults>, accessed 09/14/2022 12:24 PM.
- Schlicker, H.G. and Deacon, R.J., 1967, Engineering Geology of the Tualatin Valley region, Oregon: Oregon Department of Geology and Mineral Industries Bulletin B-60, 103 p., 5 app., 45 figs., 5 tables, 4 pls. incl. 1 geologic-hazards map and 1 depth-to-basalt map [all 1:48,000].
- Smith, Rachel L. and Roe, Warren P., 2015, Oregon Geologic Data Compilation Release 6 (OGDC-6): Oregon Department of Geology and Mineral Industries.
- Thompson, R.F., 2015, GigaFlood, the Largest of the Lake Missoula Floods in Northwest Oregon and Southwest Washington, 2nd edition, <https://www.perlego.com/book/2857524/gigaflood-pdf>, Accessed: 3 October 2022.
- United States Geological Survey, 2022, USGS Seismic Design Web Services website, <https://earthquake.usgs.gov/ws/designmaps/>, accessed 10/3/2022 10:34 AM.
- United States Geological Survey, 2022, Quaternary fault and fold database of the United States: U.S. Geological Survey website, <http://earthquake.usgs.gov/hazards/qfaults/map/#qfaults>, accessed 09/02/2022.
- Wells, R.E., Haugerud, R.A., Niem, A.R., Niem, W.A., Ma, L., Evarts, R.C., O'Connor, J.E., Madin, I.P., Sherrod, D.R., Beeson, M.H., Tolan, T.L., Wheeler, K.L., Hanson, W.B., and Sawlan, M.G., 2020, Geologic map of the greater Portland metropolitan area and surrounding region, Oregon and Washington: U.S. Geological Survey Scientific Investigations Map 3443, pamphlet 55 p., 2 sheets, scale 1:63,360, <https://doi.org/10.3133/sim3443>.

**Table 1 - Presumptive Stratigraphic Characterization Values**

Representative Borings	Depth		Layer Bottom (feet)	General Site Characterization and USCS Soil Classification <sup>1</sup>		Groundwater Depth (feet)	Total Unit Weight (pcf)	Pressuremeter Modulus (ksi)	General Soil Parameters	
	Layer Top (feet)	Layer Bottom (feet)		Classification <sup>1</sup>	Classification <sup>1</sup>				Friction Angle (deg)	Undrained Cohesion (psf)
B-1	0.4	4		CL			120	1.1	N/A	1850
	4	7		CL			115	0.7	N/A	1150
	7	12.5		CL		16	110	0.5	N/A	850
	12.5	18		ML			115	1.0	N/A	1700
	18	23		CL			115	0.8	N/A	1450
B-2	23	51.5		CH			115	0.9	N/A	1650
	0.4	6		CL			120	1.0	N/A	1850
	6	13.5		ML			110	0.5	N/A	850
	13.5	18.5		SM		N/M	110	0.2	27	N/A
	18.5	23.5		ML			105	0.2	N/A	350
B-3	23.5	27.5		CL			110	0.5	N/A	900
	27.5	31		CH			120	1.0	N/A	1850
	0.4	4.5		CL			115	0.9	N/A	1550
	4.5	11		CL			110	0.6	N/A	950
	11	18		ML			110	0.4	N/A	650
	18	22.5		CL		N/M	110	0.4	N/A	650
	22.5	48.5		CH			120	1.1	N/A	1900
	48.5	67.5		CH			115	0.7	N/A	1150
	67.5	93.5		CH			120	1.3	N/A	2300
	93.5	101.5		CH			115	0.6	N/A	1050

**Table 1 - Presumptive Stratigraphic Characterization Values**

Representative Borings	Depth		General Site Characterization and USCS Soil Classification <sup>1</sup>	Groundwater Depth (feet)	Total Unit Weight (pcf)	Pressurometer Modulus (ksi)	General Soil Parameters	
	Layer Top (feet)	Layer Bottom (feet)					Friction Angle (deg)	Undrained Cohesion (psf)
B-4	0.4	4.5	CL		115	1.0	N/A	1700
	4.5	8.5	CL		110	0.5	N/A	900
	8.5	13.5	ML	N/M	115	0.7	N/A	1300
	13.5	20	ML		105	0.3	N/A	500
	20	24.5	MH		105	0.3	N/A	500
	24.5	31.5	CH		120	1.6	N/A	2800
B-5	0.4	4.5	CH		120	1.5	N/A	2600
	4.5	9	CL		115	0.7	N/A	1300
	9	13.5	CL		105	0.3	N/A	500
	13.5	17.5	SC	N/M	110	0.3	28	N/A
	17.5	25.7	CH		110	0.4	N/A	650
	25.7	27.5	MH		120	1.6	N/A	2750
	27.5	32.5	CH		115	0.8	N/A	1450
	32.5	36.5	CH		115	0.7	N/A	1300
B-6	0.4	4.5	CH		115	0.9	N/A	1550
	4.5	7.5	CL		115	0.7	N/A	1300
	7.5	12.5	ML		115	0.6	N/A	1050
	12.5	18.5	SC		110	0.3	28	N/A
	18.5	27.5	CH	N/M	115	0.8	N/A	1350
	27.5	32	MH		110	0.4	N/A	750
	32	38	CH		115	0.8	N/A	1450
	38	52.5	CH		100	0.2	N/A	300
52.5	56.5	CH		110	0.5	N/A	900	

NOTES:  
1. Soil descriptions and parameters are estimates of conditions at the representative exploration locations. Subsurface conditions may vary away from the exploration locations.  
N/M = Not Measured, N/A = Not Applicable

Table 2 - L-Pile and Axial Capacity Parameters

Representative Borings	Depth		General Site Characterization and USCS Soil Classification <sup>1</sup>		Vertical Effective Stress (psf)		General L-Pile Input Parameters				General Deep Foundation Axial Parameters				
	Layer Top (feet)	Layer Bottom (feet)	Layer Top (psf)	Layer Bottom (psf)	L-Pile Soil Model	Friction Angle (deg)	Soil Modulus, k (pci)	Undrained Cohesion (pcf)	Strain Factor, ε <sub>50</sub>	Ultimate End Bearing (ksf)	Factor of Safety for End Bearing	Allowable Unit End Bearing (ksf)	Average Ultimate Unit Skin Friction (ksf)	Factor of Safety for Skin Friction	Average Allowable Unit Skin Friction (ksf)
B-1	0.4	4	48	480	Stiff Clay w/o Free Water (Reese)	N/A	N/A	1850	0.007	15	3	5	N/A	0.81	0.30
	4	7	480	825	Stiff Clay w/o Free Water (Reese)	N/A	N/A	1150	0.009	9	3	3	N/A	0.58	0.19
	7	12.5	825	1430	Stiff Clay w/o Free Water (Reese)	N/A	N/A	850	0.100	6	3	2	N/A	0.41	0.14
	12.5	18	1430	2063	Stiff Clay w/o Free Water (Reese)	N/A	N/A	1700	0.007	14	3	5	N/A	0.83	0.28
	18	23	2063	2638	Stiff Clay w/o Free Water (Reese)	N/A	N/A	1450	0.008	11	3	4	N/A	0.69	0.23
	23	51.5	2638	5915	Stiff Clay w/o Free Water (Reese)	N/A	N/A	1650	0.007	13	3	4	N/A	0.75	0.25
B-2	0.4	6	48	720	Stiff Clay w/o Free Water (Reese)	N/A	N/A	1850	0.007	15	3	5	N/A	0.91	0.30
	6	13.5	720	1545	Stiff Clay w/o Free Water (Reese)	N/A	N/A	850	0.100	6	3	2	N/A	0.41	0.14
	13.5	18.5	1545	2095	Sand (Reese)	27	6	N/A	N/A	2	3	1	0.24	0.43	0.14
	18.5	23.5	2095	2820	Stiff Clay w/o Free Water (Reese)	N/A	N/A	350	0.020	2	3	1	N/A	0.21	0.07
	23.5	27.5	2820	3050	Stiff Clay w/o Free Water (Reese)	N/A	N/A	900	0.010	7	3	2	N/A	0.47	0.16
	27.5	31	3050	3480	Stiff Clay w/o Free Water (Reese)	N/A	N/A	1650	0.007	15	3	5	N/A	0.91	0.30
B-3	0.4	4.5	46	518	Stiff Clay w/o Free Water (Reese)	N/A	N/A	1550	0.007	13	3	4	N/A	0.75	0.25
	4.5	11	518	1233	Stiff Clay w/o Free Water (Reese)	N/A	N/A	950	0.010	7	3	2	N/A	0.47	0.16
	11	16	1233	2003	Stiff Clay w/o Free Water (Reese)	N/A	N/A	650	0.013	4	3	1	N/A	0.34	0.11
	16	22.5	2003	2498	Stiff Clay w/o Free Water (Reese)	N/A	N/A	650	0.013	4	3	1	N/A	0.34	0.11
	22.5	48.5	2498	5618	Stiff Clay w/o Free Water (Reese)	N/A	N/A	1900	0.007	15	3	5	N/A	0.91	0.30
	48.5	67.5	5618	7803	Stiff Clay w/o Free Water (Reese)	N/A	N/A	1150	0.009	9	3	3	N/A	0.58	0.19
B-4	67.5	93.5	7803	10223	Stiff Clay w/o Free Water (Reese)	N/A	N/A	2300	0.006	19	3	6	N/A	1.16	0.39
	93.5	101.5	10223	11843	Stiff Clay w/o Free Water (Reese)	N/A	N/A	1050	0.009	8	3	3	N/A	0.53	0.18
	0.4	4.5	46	518	Stiff Clay w/o Free Water (Reese)	N/A	N/A	1700	0.007	14	3	5	N/A	0.83	0.28
	4.5	8.5	518	988	Stiff Clay w/o Free Water (Reese)	N/A	N/A	900	0.010	7	3	2	N/A	0.47	0.16
	8.5	13.5	988	1533	Stiff Clay w/o Free Water (Reese)	N/A	N/A	1300	0.008	10	3	3	N/A	0.64	0.21
	13.5	20	1533	2215	Stiff Clay w/o Free Water (Reese)	N/A	N/A	500	0.017	3	3	1	N/A	0.28	0.09
	20	24.5	2215	2688	Stiff Clay w/o Free Water (Reese)	N/A	N/A	500	0.017	3	3	1	N/A	0.28	0.09
	24.5	31.5	2688	3528	Stiff Clay w/o Free Water (Reese)	N/A	N/A	2800	0.005	24	3	8	N/A	1.49	0.50



Table 2 - L-Pile and Axial Capacity Parameters

Representative Borings	Depth		Vertical Effective Stress (psf)		General L-Pile Input Parameters				General Deep Foundation Axial Parameters								
	Layer Top (feet)	Layer Bottom (feet)	Layer Top (psf)	Layer Bottom (psf)	L-Pile Soil Model	Friction Angle (deg)	Soil Modulus, k (pci)	Undrained Cohesion (psf)	Strain Factor, ε50	Ultimate Unit End Bearing (ksf)	Factor of Safety for End Bearing	Allowable Unit End Bearing (ksf)	Average Ultimate Unit Skin Friction (ksf)	Factor of Safety for Skin Friction	Average Allowable Unit Skin Friction (ksf)		
B-5	0.4	4.5	48	540	Stiff Clay w/o Free Water (Reese)	N/A	N/A	2800	0.005	23	3	8	N/A	1.40	3	0.47	
	4.5	9	540	1058	Stiff Clay w/o Free Water (Reese)	N/A	N/A	1900	0.008	10	3	3	N/A	0.64	3	0.21	
	9	13.5	1058	1530	Stiff Clay w/o Free Water (Reese)	N/A	N/A	500	0.017	3	3	1	N/A	0.28	3	0.09	
	13.5	17.5	1530	1970	Sand (Reese)	28	10	N/A	N/A	4	3	1	0.24	0.42	3	0.14	
	17.5	25.7	1970	2872	Stiff Clay w/o Free Water (Reese)	N/A	N/A	650	0.013	4	3	1	N/A	0.34	3	0.11	
	25.7	27.5	2872	3088	Stiff Clay w/o Free Water (Reese)	N/A	N/A	2750	0.005	24	3	8	N/A	1.49	3	0.50	
	27.5	32.5	3088	3663	Stiff Clay w/o Free Water (Reese)	N/A	N/A	1450	0.008	11	3	4	N/A	0.69	3	0.23	
	32.5	36.5	3663	4123	Stiff Clay w/o Free Water (Reese)	N/A	N/A	1300	0.008	10	3	3	N/A	0.64	3	0.21	
	36.5	40.5	4123	4608	Stiff Clay w/o Free Water (Reese)	N/A	N/A	1550	0.007	13	3	4	N/A	0.75	3	0.25	
	40.5	44.5	4608	5118	Stiff Clay w/o Free Water (Reese)	N/A	N/A	1300	0.008	10	3	3	N/A	0.64	3	0.21	
B-6	4.5	7.5	518	663	Stiff Clay w/o Free Water (Reese)	N/A	N/A	1050	0.009	8	3	3	N/A	0.53	3	0.18	
	7.5	12.5	663	1438	Stiff SH w/o Free Water (Reese)	N/A	N/A	N/A	N/A	4	3	1	0.24	0.43	3	0.14	
	12.5	18.5	1438	2098	Sand (Reese)	28	10	N/A	N/A	10	3	3	N/A	0.64	3	0.21	
	18.5	27.5	2098	3133	Stiff Clay w/o Free Water (Reese)	N/A	N/A	1350	0.008	6	3	2	N/A	0.41	3	0.14	
	27.5	32	3133	3628	Stiff Clay w/o Free Water (Reese)	N/A	N/A	750	0.100	11	3	4	N/A	0.69	3	0.23	
	32	38	3628	4318	Stiff Clay w/o Free Water (Reese)	N/A	N/A	300	0.020	1	3	0.4	N/A	0.14	3	0.05	
	38	52.5	4318	5768	Stiff Clay w/o Free Water (Reese)	N/A	N/A	900	0.010	7	3	2	N/A	0.47	3	0.16	
	52.5	56.5	5768	6208	Stiff Clay w/o Free Water (Reese)	N/A	N/A										

NOTES:  
1 Soil descriptions and parameters are estimates of conditions at the representative exploration locations. Subsurface conditions may vary away from the exploration locations.  
N/A = Not Measured; N/A = Not Applicable



Filename: P:\GIS\PD\X\109000a\109680\_PGE Memorial Sub\Avr\mxd\VicinityMap.mxd Date: 9/30/2022 Login: AEH



Sources: Esri, HERE, Garmin, Intermap, increment P Corp., GEBCO, USGS, FAO, NPS, NRCAN, GeoBase, IGN, Kadaster NL, Ordnance Survey, Esri Japan, METI, Esri China (Hong Kong), (c) OpenStreetMap contributors, and the GIS User Community

PGE Memorial Substation  
Wilsonville, Oregon

**VICINITY MAP**

November 2022

109680

**SHANNON & WILSON, INC.**  
GEOTECHNICAL AND ENVIRONMENTAL CONSULTANTS

**FIG. 1**



- LEGEND**
- B-1 Designation and Approximate Location of Boring
  - IT-1 Designation and Approximate Location of Infiltration Test
  - Approximate Location of Proposed Site Features

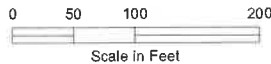

PGE Memorial Substation  
Wilsonville, Oregon

FIG. 2

- NOTES**
1. Aerial imagery obtained through Google Maps Satellite.
  2. Taxiots obtained through Metro RLIS.
  3. Proposed features from file MMRL-1001-1.dwg, provided by POWER Engineers, Inc., on November 3, 2022.

**SITE AND EXPLORATION PLAN**

November 2022 109680

**SHANNON & WILSON, INC.**  
HYDROLOGICAL AND ENVIRONMENTAL CONSULTANTS

**FIG. 2**

Appendix A: Conceptual Plans

Appendix A

# Conceptual Plans

APPENDIX A: CONCEPTUAL PLANS



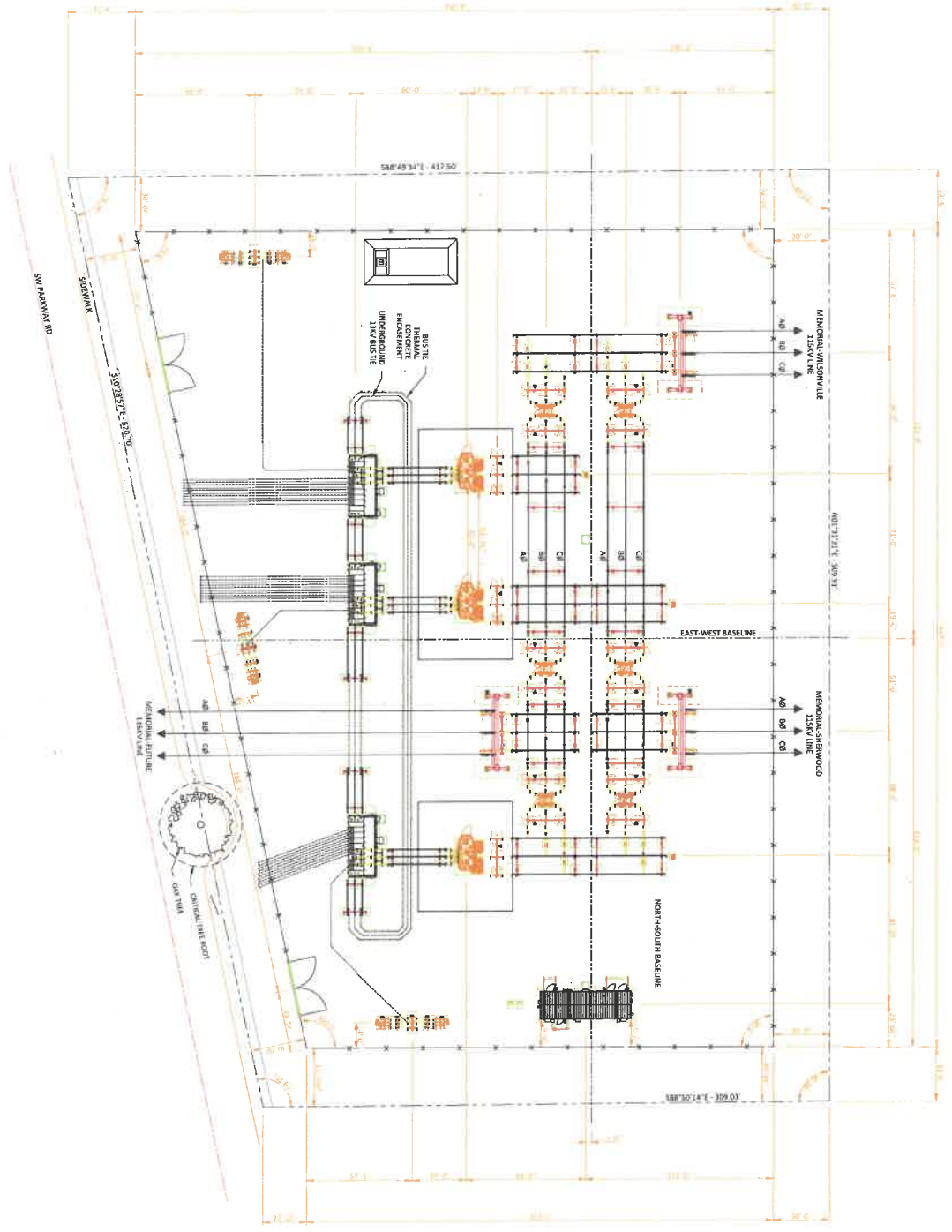

VICINITY MAP  
SCALE NONE

**LEGEND:**

- FENCE
- FOUNDATION ABOVE GRADE
- FOUNDATION BELOW GRADE
- PROPERTY LINE
- STATION BASELINE
- CONDUIT VAULT
- LIGHT POLE
- ▲ SWITCH OPERATOR

**PGE Internal Use**  
Access limited to PGE

**15% IFCR NOT FOR CONSTRUCTION**

MMRL-1001  
REV 0  
SHEET 1 OF 1  
DATE 11/11/11  
DWT AD  
SCALE 1"=30'-0"

**MEMORIAL SUBSTATION  
FUTURE GENERAL LAYOUT**



REV.	DATE	REVISION DESCRIPTION	DESIGNED	CHECKED	APPROVED
0	10-10-12	ORIGINAL ISSUE: AWO 1000009925.	PEI	JDJ	AFL

## Appendix B

## Field Explorations

## CONTENTS

B.1	General.....	1
B.2	Geotechnical Drilling.....	1
B.2.1	Hollow Stem Auger Drilling .....	1
B.2.2	Mud Rotary Drilling .....	2
B.3	Soil Sampling.....	2
B.3.1	Disturbed Sampling.....	2
B.3.2	Relatively Undisturbed Sampling .....	3
B.4	Material Descriptions .....	3
B.5	Logs of Borings.....	3
B.6	Borehole Abandonment .....	4
B.7	Infiltration Testing .....	4

## Tables

Table B-1: Summary of Geotechnical Borehole Information

## Figures

Figure B1: Soil Description and Log Key  
 Figure B2: Log of Boring B-01  
 Figure B3: Log of Boring B-02  
 Figure B4: Log of Boring B-03  
 Figure B5: Log of Boring B-04  
 Figure B6: Log of Boring B-05  
 Figure B7: Log of Boring B-06  
 Figure B8: Infiltration Test Results INF-01

## B.1 GENERAL

Subsurface explorations for the PGE Memorial Substation project consisted of performing a total of six geotechnical borings, designated B-01 through B-06, and performing one in-situ infiltration test designated INF-01. The geotechnical borings were advanced to depths ranging from 31 to 101.5 feet below ground surface (bgs), and the in-situ infiltration test was performed at a depth of approximately 12-inches bgs. Locations of the explorations were measured in the field from existing structures, and GPS points were taken to reference the locations. The exploration locations are shown on the Site and Exploration Plan, Figure 2. This appendix describes the techniques used to perform the explorations, presents logs of the materials encountered and presents the results of in-situ infiltration testing.

## B.2 GEOTECHNICAL DRILLING

The geotechnical borings were completed between August 22<sup>nd</sup> and 24<sup>th</sup>, 2022, using a standard truck mounted CME-75 drill rig provided and operated by Western States Soil Conservation, Inc. (Western States) of Hubbard, Oregon. Boring B-01 was completed to a depth of 51.5 feet using hollow-stem auger drilling technique, B-02 was completed to a depth of 31 feet, B-03 was completed to a depth of 101.5 feet, B-04 was completed to a depth of 31.5 feet, B-05 was completed to a depth of 36.5 feet, and B-06 was completed to a depth of 56.5 feet. Borings B-02 through B-06 were advanced using open-hole mud rotary drilling techniques. A Shannon & Wilson geologist was present during the explorations to locate the borings, observe the drilling, collect soil samples, and log the materials encountered. Table A-1 at the end of this Appendix provides a summary of geotechnical borehole information.

### B.2.1 Hollow Stem Auger Drilling

During hollow-stem auger drilling, the boring is advanced by sections, or flights, of augers that are rotated into the ground. A cutting head is attached to the first flight and the cuttings, or spoils, are rotated to the surface as the borehole is advanced. A pilot or center bit can be held at the base of the first flight with drill rods to prevent cuttings from entering the center of the auger. When the bit is removed, samples can be obtained through the hollow portion of the auger. In general, the introduction of drilling fluids is not required so hollow-stem auger drilling allows the observation of groundwater if encountered, and also if left in the ground act as a piezometer for measurement of groundwater depth. The hollow-stem auger also acts as a casing while the boring is being advanced, preventing the

side walls from collapsing into the boring. The most common size of auger has an outside diameter of 6.25 inches, which generally creates a 7- to 8-inch-diameter hole.

### B.2.2 Mud Rotary Drilling

Mud rotary borings are typically advanced using a tri-cone bit and a string of hollow drill rods (narrower than the bit) through which bentonite drilling mud is pumped and typically through an open, uncased borehole. The mud is mixed on-site using water and powdered bentonite. The drilling mud serves to cool the bit, keep the hole open, and flush the cuttings to the surface. Returning drill mud is typically passed through a screen and into a tub over the hole. The screen collects the soil cuttings, and the tub collects the mud for recirculation back into the hole. If fine-grained, cohesive soils are encountered, other styles of drill bits may also be used with the mud-rotary method, such as scraper or drag bits.

## B.3 SOIL SAMPLING

### B.3.1 Disturbed Sampling

Disturbed samples were collected in the borings, typically at 2.5- to 5-foot depth intervals, using a standard 2-inch-outside-diameter (O.D.) split spoon sampler in conjunction with Standard Penetration Testing. In a Standard Penetration Test (SPT), ASTM D1586, the sampler is driven 18 inches into the soil using a 140-pound hammer dropped 30 inches. The number of blows required to drive the sampler the last 12 inches is defined as the standard penetration resistance, or N-value. The SPT N-value provides a measure of in situ relative density of cohesionless soils (silt, sand, and gravel), and the consistency of cohesive soils (silt and clay). All disturbed samples were visually identified and described in the field, sealed to retain moisture, and returned to our laboratory for additional examination.

SPT N-values can be significantly affected by several factors, including the efficiency of the hammer used. Automatic hammers generally have higher energy transfer efficiencies than cathead-driven (manual) hammers. For reference, cathead hammers are typically assumed to have an average energy efficiency of 60 percent. Based on truck mounted CME-75 drill rig averaged 84.1 percent. All N-values presented in this report are in blows per foot, as counted in the field. No corrections of any kind have been applied.

An SPT was considered to have met refusal where more than 50 blows were required to drive the sampler 6 inches. If refusal was encountered in the first 6-inch interval (for example, 50 for 1.5"), the count is reported as 50/1st 1.5". If refusal was encountered in the second 6-inch interval (for example, 48, 50 for 1.5"), the count is reported as 50/1.5". If



refusal was encountered in the last 6-inch interval (for example, 39, 48, 50 for 1.5"), the count is reported as 98/7.5".

### B.3.2 Relatively Undisturbed Sampling

Relatively undisturbed samples were collected in 3-inch O.D. thin-wall Shelby tubes which were hydraulically pushed into the undisturbed soil at the bottoms of boreholes. Relatively undisturbed samples were collected in each boring at the depth of 5 feet for electrical resistivity testing and were also collected in select borings if soft cohesive material was encountered. The soils exposed at the ends of the tubes were examined and described in the field. After examination, the ends of the tubes were sealed to preserve the natural moisture of the samples. The sealed tubes were stored in the upright position and care was taken to avoid shock and vibration during their transport and storage in our laboratory.

## B.4 MATERIAL DESCRIPTIONS

In the field, soil samples were identified visually in general accordance with ASTM D2488 Standard Practice for Description and Identification of Soils (Visual-Manual Procedure). Consistency, color, relative moisture, degree of plasticity, peculiar odors and other distinguishing characteristics of the samples were noted. Once returned to the laboratory, soil samples were re-examined, and field identifications were modified as necessary. We refined our visual-manual soil identifications based on additional observation using elements of the Standard Practice for Classification of Soils for Engineering Purposes (Unified Soil Classification System), ASTM D2487. The specific terminology used in the soil identifications is defined on the Soil Description and Log Key, Figure B1.

## B.5 LOGS OF BORINGS

Summary logs of all Shannon & Wilson geotechnical borings are presented in Figures B2 through B7. Material descriptions and interfaces on the logs are interpretive, and actual changes may be gradual. The left-hand portion of the boring logs provides description, identification, and geotechnical unit designation for the materials encountered in the boring. The right-hand portion of the boring logs shows a graphic log, sample locations and designations, backfill details, and a graphical representation of N-values, natural water contents, Atterberg limits, and sample recovery.

## B.6 BOREHOLE ABANDONMENT

Borings were backfilled with bentonite-cement grout and bentonite chips in accordance with Oregon Water Resource Department regulations, up to a depth of approximately 2 feet. On site surface soil, or gravel fill material was used as backfill from approximately 2 feet up to the ground surface.

## B.7 INFILTRATION TESTING

One in situ infiltration test was completed using the Standard Test Method for Infiltration Rate of Soils in Field Using Double-Ring Infiltrometer in accordance with ASTM D3385. The infiltration test was performed at location INF-01, shown on the Site and Exploration Plan, Figure 2. At the infiltration test location, the area was excavated to an approximate depth of 6-inches by hand tooling. The Double-ring Infiltration test was performed on August 26, 2022. The double-ring infiltrometer consisting of 24-inch diameter outer and a 12-inch diameter rings, 20-inches in height was driven into the ground of the excavated area with a sledge to a depth of 6-inches. The volume of liquid used to maintain a reference head of 6-inches of water in the inner and outer rings was measured at time intervals of 15 minutes for the first hour, 30 minutes for the second hour, and 60 minutes thereafter until a relatively constant rate is obtained or a minimum total amount of 6 hours. The ground temperature of the mid-depth of the test zone and temperature of the inner and outer water heads is also measured. The results of the last two measurements indicated a constant rate of 1.8 inches/hour. No corrections factors were applied to the measured infiltration rate presented. The Infiltration test results are presented in Figure B8.

**Table B-1: Summary of Geotechnical Borehole Information.**

Borehole Designation	Sample Designation	Sample Type	Sample Depth (ft)	Time Sampled	Notes
B-1	S-1	SPT	1.5-2	0825	-
B-1	S-2	TW	5-7	0835	-
B-1	S-3	SPT	7-8.5	0843	-
B-1	S-4	SPT	10-11.5	0848	-
B-1	S-5	SPT	15-16.5	0852	-
B-1	S-6	SPT	20-21.5	0904	-
B-1	S-7	SPT	25-26.5	0910	-
B-1	S-8	SPT	30-31.5	0924	-
B-1	S-9	SPT	35-36.5	0935	-
B-1	S-10	SPT	40-41.5	0948	-
B-1	S-11	SPT	45-46.5	1002	-
B-1	S-12	SPT	50-51.5	1015	-
B-2	S-1	SPT	2.5-4	1009	-

## APPENDIX B: FIELD EXPLORATIONS

B-2	S-2	TW	5-7	1018	-
B-2	S-3	SPT	7-8.5	1023	-
B-2	S-4	SPT	10-11.5	1029	-
B-2	S-5	SPT	15-16.5	1035	-
B-2	S-6	SPT	20-21.5	1042	-
B-2	S-7	SPT	25-26.5	1050	-
B-2	S-8	TW	28-29.5	1100	-
B-2	S-9	SPT	29.5-31	1106	-
B-3	S-1	SPT	2.5-4	1108	-
B-3	S-2	TW	5-7	1115	-
B-3	S-3	SPT	7-8.5	1122	-
B-3	S-4	SPT	10-11.5	1127	-
B-3	S-5	SPT	15-16.5	1133	-
B-3	S-6	SPT	20-21.5	1138	-
B-3	S-7	SPT	25-26.5	1155	-
B-3	S-8	SPT	30-31.5	1202	-
B-3	S-9	SPT	35-36.5	1230	-
B-3	S-10	SPT	40-41.5	1315	-
B-3	S-11	SPT	45-46.5	1328	-
B-3	S-12	SPT	50-51.5	1349	-
B-3	S-13	SPT	55-56.5	1410	-
B-3	S-14	SPT	60-61.5	1424	-
B-3	S-15	SPT	65-66.5	1440	-
B-3	S-16	SPT	70-71.5	1451	-
B-3	S-17	SPT	75-76.5	1515	-
B-3	S-18	SPT	80-81.5	1535	-
B-3	S-19	SPT	85-86.5	0827	-
B-3	S-20	SPT	90-91.5	0848	-
B-3	S-21	SPT	95-96.5	0920	-
B-3	S-22	SPT	100-101.5	0955	-
B-4	S-1	SPT	2.5-4	0835	-
B-4	S-2	TW	5-6.3	0841	-
B-4	S-3	SPT	6.3-7.8	0846	-
B-4	S-4	SPT	10-11.5	0852	-
B-4	S-5	SPT	15-16.5	0857	-
B-4	S-6	TW	20-22	0906	-
B-4	S-7	SPT	22-23.5	0915	-
B-4	S-8	TW	25-26.5	0922	-
B-4	S-9	SPT	26.5-28	0930	-
B-4	S-10	SPT	30-31.5	0936	-
B-5	S-1	SPT	2.5-4	1035	-
B-5	S-2	TW	5-7	1045	-
B-5	S-3	SPT	7-8.5	1055	-

B-5	S-4	SPT	10-11.5	1103	-
B-5	S-5	SPT	15-16.5	1108	-
B-5	S-6	SPT	20-21.5	1112	-
B-5	S-7	TW	25-27	1125	-
B-5	S-8	SPT	27-28.5	1130	-
B-5	S-9	SPT	30-31.5	1137	-
B-5	S-10	TW	33-35	1145	-
B-5	S-11	SPT	35-36.5	1155	-
B-6	S-1	SPT	2.5-4	1230	-
B-6	S-2	TW	5-7	1240	-
B-6	S-3	SPT	10-11.5	1250	-
B-6	S-4	SPT	15-16.5	1256	-
B-6	S-5	SPT	20-21.5	1304	-
B-6	S-6	SPT	25-26.5	1314	-
B-6	S-7	SPT	30-31.5	1322	-
B-6	S-8	TW	33-34	1330	-
B-6	S-9	SPT	34-35.5	1345	-
B-6	S-10	SPT	40-41.5	1400	-
B-6	S-11	SPT	45-46.5	1415	-
B-6	S-12	SPT	50-51.5	1425	-
B-6	S-13	SPT	55-56.5	1439	-

## Notes:

- 1 SPT-Split Spoon Sample, TW- Thin Wall Shelby Tube Sample, LL-Liquid Limit, PL-Plastic Limit, PI-Plasticity Index, MC-Moisture Content

Shannon & Wilson, Inc. (S&W), uses a soil identification system modified from the Unified Soil Classification System (USCS). Elements of the USCS and other definitions are provided on this and the following pages. Soil descriptions are based on visual-manual procedures (ASTM D2488) and laboratory testing procedures (ASTM D2487), if performed.

### S&W INORGANIC SOIL CONSTITUENT DEFINITIONS

CONSTITUENT <sup>2</sup>	FINE-GRAINED SOILS (50% or more fines) <sup>1</sup>	COARSE-GRAINED SOILS (less than 50% fines) <sup>1</sup>
<b>Major</b>	<b>Silt, Lean Clay, Elastic Silt, or Fat Clay<sup>3</sup></b>	<b>Sand or Gravel<sup>4</sup></b>
<b>Modifying (Secondary)</b> Precedes major constituent	30% or more coarse-grained: <b>Sandy or Gravelly<sup>4</sup></b>	More than 12% fine-grained: <b>Silty or Clayey<sup>3</sup></b>
<b>Minor</b> Follows major constituent	15% to 30% coarse-grained: <b>with Sand or with Gravel<sup>4</sup></b> 30% or more total coarse-grained and lesser coarse-grained constituent is 15% or more: <b>with Sand or with Gravel<sup>5</sup></b>	5% to 12% fine-grained: <b>with Silt or with Clay<sup>3</sup></b> 15% or more of a second coarse-grained constituent: <b>with Sand or with Gravel<sup>5</sup></b>

<sup>1</sup>All percentages are by weight of total specimen passing a 3-inch sieve.

<sup>2</sup>The order of terms is: *Modifying Major with Minor*.

<sup>3</sup>Determined based on behavior.

<sup>4</sup>Determined based on which constituent comprises a larger percentage.

<sup>5</sup>Whichever is the lesser constituent.

### MOISTURE CONTENT TERMS

Dry	Absence of moisture, dusty, dry to the touch
Moist	Damp but no visible water
Wet	Visible free water, from below water table

### STANDARD PENETRATION TEST (SPT) SPECIFICATIONS

Hammer:	140 pounds with a 30-inch free fall. Rope on 6- to 10-inch-diam. cathead 2-1/4 rope turns, > 100 rpm
Sampler:	10 to 30 inches long Shoe I.D. = 1.375 inches Barrel I.D. = 1.5 inches Barrel O.D. = 2 inches
N-Value:	Sum blow counts for second and third 6-inch increments. Refusal: 50 blows for 6 inches or less; 10 blows for 0 inches.
<b>NOTE:</b> Penetration resistances (N-values) shown on boring logs are as recorded in the field and have not been corrected for hammer efficiency, overburden, or other factors.	













### PARTICLE SIZE DEFINITIONS

DESCRIPTION	SIEVE NUMBER AND/OR APPROXIMATE SIZE
FINES	< #200 (0.075 mm = 0.003 in.)
SAND Fine Medium Coarse	#200 to #40 (0.075 to 0.4 mm; 0.003 to 0.02 in.) #40 to #10 (0.4 to 2 mm; 0.02 to 0.08 in.) #10 to #4 (2 to 4.75 mm; 0.08 to 0.187 in.)
GRAVEL Fine Coarse	#4 to 3/4 in. (4.75 to 19 mm; 0.187 to 0.75 in.) 3/4 to 3 in. (19 to 76 mm)
COBBLES	3 to 12 in. (76 to 305 mm)
BOULDERS	> 12 in. (305 mm)

### RELATIVE DENSITY / CONSISTENCY

COHESIONLESS SOILS		COHESIVE SOILS	
N, SPT, BLOWS/FT.	RELATIVE DENSITY	N, SPT, BLOWS/FT.	RELATIVE CONSISTENCY
< 4	Very loose	< 2	Very soft
4 - 10	Loose	2 - 4	Soft
10 - 30	Medium dense	4 - 8	Medium stiff
30 - 50	Dense	8 - 15	Stiff
> 50	Very dense	15 - 30	Very stiff
		> 30	Hard

### WELL AND BACKFILL SYMBOLS

	Bentonite		Surface Cement Seal
	Cement Grout		Asphalt or Cap
	Bentonite Grout		Slough
	Bentonite Chips		Inclinometer or Non-perforated Casing
	Silica Sand		Vibrating Wire Piezometer
	Gravel		
	Perforated or Screened Casing		

### PERCENTAGES TERMS<sup>1,2</sup>

Trace	< 5%
Few	5 to 10%
Little	15 to 25%
Some	30 to 45%
Mostly	50 to 100%

<sup>1</sup>Gravel, sand, and fines estimated by mass. Other constituents, such as organics, cobbles, and boulders, estimated by volume.

<sup>2</sup>Reprinted, with permission, from ASTM D2488 - 09a Standard Practice for Description and Identification of Soils (Visual-Manual Procedure), copyright ASTM International, 100 Barr Harbor Drive, West Conshohocken, PA 19428. A copy of the complete standard may be obtained from ASTM International, www.astm.org.

PGE Memorial Substation  
Wilsonville, Oregon

## SOIL DESCRIPTION AND LOG KEY

November 2022

109680

**SHANNON & WILSON, INC.**  
Geotechnical and Environmental Consultants

**FIG. B1**  
Sheet 1 of 3



UNIFIED SOIL CLASSIFICATION SYSTEM (USCS) (Modified From USACE Tech Memo 3-357, ASTM D2487, and ASTM D2488)				
MAJOR DIVISIONS		GROUP/GRAPHIC SYMBOL	TYPICAL IDENTIFICATIONS	
COARSE-GRAINED SOILS (more than 50% retained on No. 200 sieve)	Gravels (more than 50% of coarse fraction retained on No. 4 sieve)	Gravel (less than 5% fines)	GW 	Well-Graded Gravel; Well-Graded Gravel with Sand
			GP 	Poorly Graded Gravel; Poorly Graded Gravel with Sand
		Silty or Clayey Gravel (more than 12% fines)	GM 	Silty Gravel; Silty Gravel with Sand
			GC 	Clayey Gravel; Clayey Gravel with Sand
	Sands (50% or more of coarse fraction passes the No. 4 sieve)	Sand (less than 5% fines)	SW 	Well-Graded Sand; Well-Graded Sand with Gravel
			SP 	Poorly Graded Sand; Poorly Graded Sand with Gravel
		Silty or Clayey Sand (more than 12% fines)	SM 	Silty Sand; Silty Sand with Gravel
			SC 	Clayey Sand; Clayey Sand with Gravel
FINE-GRAINED SOILS (50% or more passes the No. 200 sieve)	Silts and Clays (liquid limit less than 50)	Inorganic	ML 	Silt; Silt with Sand or Gravel; Sandy or Gravelly Silt
			CL 	Lean Clay; Lean Clay with Sand or Gravel; Sandy or Gravelly Lean Clay
		Organic	OL 	Organic Silt or Clay; Organic Silt or Clay with Sand or Gravel; Sandy or Gravelly Organic Silt or Clay
	Silts and Clays (liquid limit 50 or more)	Inorganic	MH 	Elastic Silt; Elastic Silt with Sand or Gravel; Sandy or Gravelly Elastic Silt
			CH 	Fat Clay; Fat Clay with Sand or Gravel; Sandy or Gravelly Fat Clay
		Organic	OH 	Organic Silt or Clay; Organic Silt or Clay with Sand or Gravel; Sandy or Gravelly Organic Silt or Clay
HIGHLY-ORGANIC SOILS	Primarily organic matter, dark in color, and organic odor	PT 	Peat or other highly organic soils (see ASTM D4427)	
FILL	Placed by humans, both engineered and nonengineered. May include various soil materials and debris.		The Fill graphic symbol is combined with the soil graphic that best represents the observed material	

NOTE: No. 4 size = 4.75 mm = 0.187 in.; No. 200 size = 0.075 mm = 0.003 in.

NOTES

- Dual symbols (symbols separated by a hyphen, i.e., SP-SM, Sand with Silt) are used for soils with between 5% and 12% fines or when the liquid limit and plasticity index values plot in the CL-ML area of the plasticity chart.
- Borderline symbols (symbols separated by a slash, i.e., CL/ML, Lean Clay to Silt; SP-SM/SM, Sand with Silt to Silty Sand) indicate that the soil properties are close to the defining boundary between two groups.
- The soil graphics above represent the various USCS identifications (i.e., GP, SM, etc.) and may be augmented with additional symbology to represent differences within USCS designations. Sandy Silt (ML), for example, may be accompanied by the ML soil graphic with sand grains added. Non-USCS materials may be represented by other graphic symbols; see log for descriptions.

PGE Memorial Substation Wilsonville, Oregon	
<b>SOIL DESCRIPTION AND LOG KEY</b>	
November 2022	109680
<b>SHANNON &amp; WILSON, INC.</b> Geotechnical and Environmental Consultants	<b>FIG. B1</b> Sheet 2 of 3

**GRADATION TERMS**

Poorly Graded	Narrow range of grain sizes present or, within the range of grain sizes present, one or more sizes are missing (Gap Graded). Meets criteria in ASTM D2487, if tested.
Well-Graded	Full range and even distribution of grain sizes present. Meets criteria in ASTM D2487, if tested.

**CEMENTATION TERMS<sup>1</sup>**

Weak	Crumbles or breaks with handling or slight finger pressure
Moderate	Crumbles or breaks with considerable finger pressure
Strong	Will not crumble or break with finger pressure

**PLASTICITY<sup>2</sup>**

DESCRIPTION	VISUAL-MANUAL CRITERIA	APPROX. PLASTICITY INDEX RANGE
Nonplastic	A 1/8-in. thread cannot be rolled at any water content.	< 4%
Low	A thread can barely be rolled and a lump cannot be formed when drier than the plastic limit.	4 to 10%
Medium	A thread is easy to roll and not much time is required to reach the plastic limit. The thread cannot be rerolled after reaching the plastic limit. A lump crumbles when drier than the plastic limit.	10 to 20%
High	It take considerable time rolling and kneading to reach the plastic limit. A thread can be rerolled several times after reaching the plastic limit. A lump can be formed without crumbling when drier than the plastic limit.	> 20%

**ADDITIONAL TERMS**

Mottled	Irregular patches of different colors.
Bioturbated	Soil disturbance or mixing by plants or animals.
Diamict	Nonsorted sediment; sand and gravel in silt and/or clay matrix.
Cuttings	Material brought to surface by drilling.
Slough	Material that caved from sides of borehole.
Sheared	Disturbed texture, mix of strengths.

**PARTICLE ANGULARITY AND SHAPE TERMS<sup>1</sup>**

Angular	Sharp edges and unpolished planar surfaces.
Subangular	Similar to angular, but with rounded edges.
Subrounded	Nearly planar sides with well-rounded edges.
Rounded	Smoothly curved sides with no edges.
Flat	Width/thickness ratio > 3.
Elongated	Length/width ratio > 3.

**ACRONYMS AND ABBREVIATIONS**

ATD	At Time of Drilling
approx.	Approximate/Approximately
Diam.	Diameter
Elev.	Elevation
ft.	Feet
FeO	Iron Oxide
gal.	Gallons
Horiz.	Horizontal
HSA	Hollow Stem Auger
I.D.	Inside Diameter
in.	Inches
lbs.	Pounds
MgO	Magnesium Oxide
mm	Millimeter
MnO	Manganese Oxide
NA	Not Applicable or Not Available
NP	Nonplastic
O.D.	Outside Diameter
OW	Observation Well
pcf	Pounds per Cubic Foot
PID	Photo-Ionization Detector
PMT	Pressuremeter Test
ppm	Parts per Million
psi	Pounds per Square Inch
PVC	Polyvinyl Chloride
rpm	Rotations per Minute
SPT	Standard Penetration Test
USCS	Unified Soil Classification System
q <sub>u</sub>	Unconfined Compressive Strength
VWP	Vibrating Wire Piezometer
Vert.	Vertical
WOH	Weight of Hammer
WOR	Weight of Rods
Wt.	Weight

**STRUCTURE TERMS<sup>1</sup>**

Interbedded	Alternating layers of varying material or color with layers at least 1/4-inch thick; singular: bed.
Laminated	Alternating layers of varying material or color with layers less than 1/4-inch thick; singular: lamination.
Fissured	Breaks along definite planes or fractures with little resistance.
Slickensided	Fracture planes appear polished or glossy; sometimes striated.
Blocky	Cohesive soil that can be broken down into small angular lumps that resist further breakdown.
Lensed	Inclusion of small pockets of different soils, such as small lenses of sand scattered through a mass of clay.
Homogeneous	Same color and appearance throughout.

PGE Memorial Substation  
Wilsonville, Oregon

**SOIL DESCRIPTION  
AND LOG KEY**

November 2022

109680

**SHANNON & WILSON, INC.**  
Geotechnical and Environmental Consultants

**FIG. B1**  
Sheet 3 of 3

<sup>1</sup>Reprinted, with permission, from ASTM D2488 - 09a Standard Practice for Description and Identification of Soils (Visual-Manual Procedure), copyright ASTM International, 100 Barr Harbor Drive, West Conshohocken, PA 19428. A copy of the complete standard may be obtained from ASTM International, www.astm.org.

<sup>2</sup>Adapted, with permission, from ASTM D2488 - 09a Standard Practice for Description and Identification of Soils (Visual-Manual Procedure), copyright ASTM International, 100 Barr Harbor Drive, West Conshohocken, PA 19428. A copy of the complete standard may be obtained from ASTM International, www.astm.org.



Total Depth: 51.5 ft.	Northing: ~ 611,088 ft.	Drilling Method: Hollow Stem Auger	Hole Diam.: 8 in.
Top Elevation: ~ 224 ft.	Easting: ~ 7,618,886 ft.	Drilling Company: Western States	Rod Type: NWJ
Vert. Datum: NAVD88	Station: ~	Drill Rig Equipment: CME-75 Truck Rig #1	Hammer Type: Automatic
Horiz. Datum: OR83-NIF	Offset: ~	Other Comments: Hammer Efficiency = 81.4%	

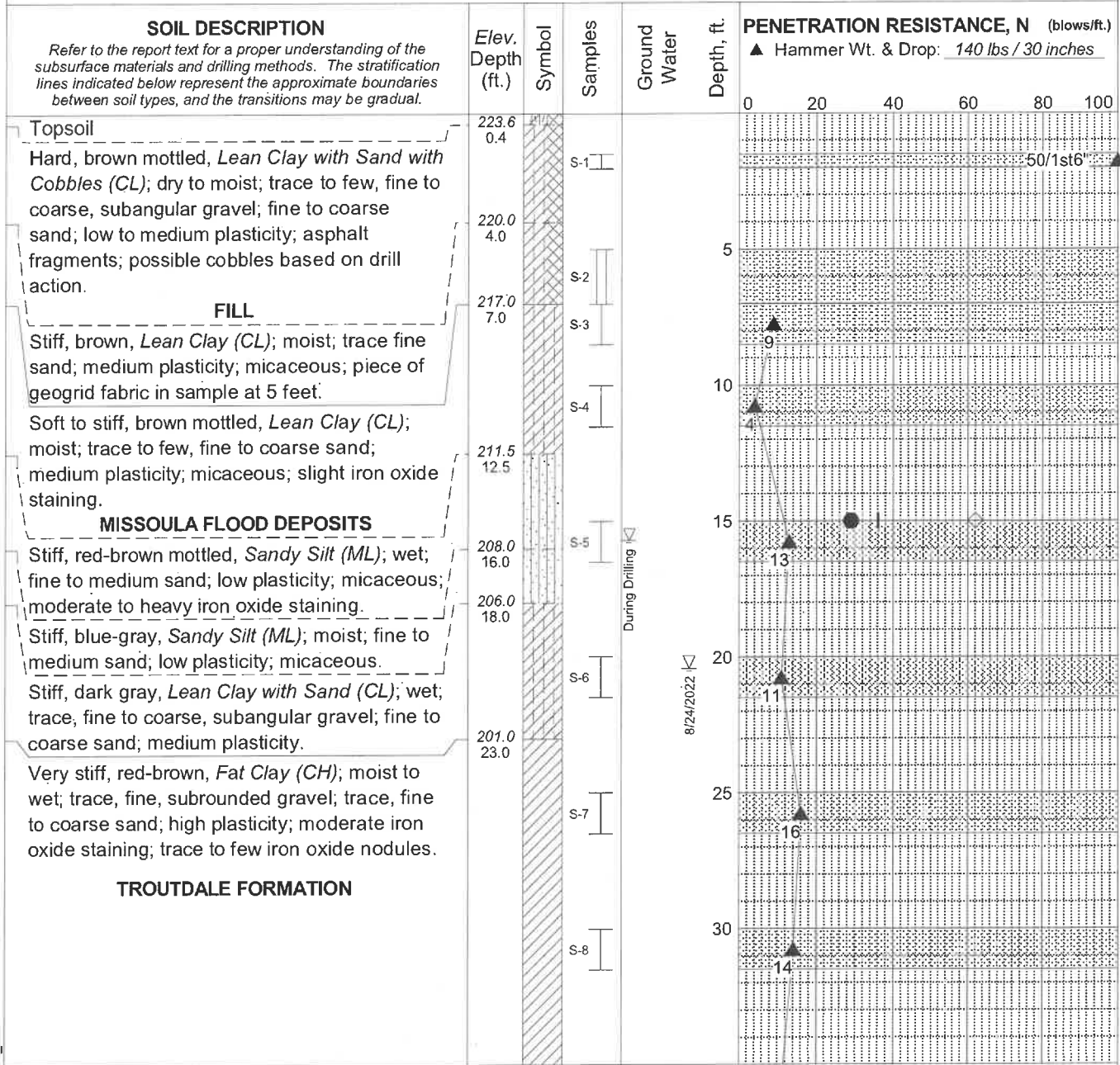

CONTINUED NEXT SHEET

**LEGEND**

- Standard Penetration Test
- 3" O.D. Shelby Tube
- Groundwater Level ATD

- Recovery (%)
- % Fines (<0.075mm)
- % Water Content
- Plastic Limit
- Liquid Limit

**NOTES**

- Refer to KEY for explanation of symbols, codes, abbreviations, and definitions.
- Groundwater level, if indicated above, is for the date specified and may vary.
- Group symbol is based on visual-manual identification and selected lab testing.
- The hole location and elevation should be considered approximate.

PGE Memorial Substation  
Wilsonville, Oregon

**LOG OF BORING B-01**

November 2022

109680

**SHANNON & WILSON, INC.**  
Geotechnical and Environmental Consultants

**FIG. B2**  
Sheet 1 of 2

Log: SCS  
 Rev: CKS  
 Typ: VCB  
 MASTER\_LOG\_E\_109680.GPJ SW2013\LIBRARY\PD\X\_GLB\_SHANWIL\_PDX.GDT 11/15/22

Total Depth: 51.5 ft.	Northing: ~ 611,088 ft.	Drilling Method: Hollow Stem Auger	Hole Diam.: 8 in.
Top Elevation: ~ 224 ft.	Easting: ~ 7,618,886 ft.	Drilling Company: Western States	Rod Type: NWJ
Vert. Datum: NAVD88	Station: ~	Drill Rig Equipment: CME-75 Truck Rig #1	Hammer Type: Automatic
Horiz. Datum: OR83-NIF	Offset: ~	Other Comments: Hammer Efficiency = 81.4%	

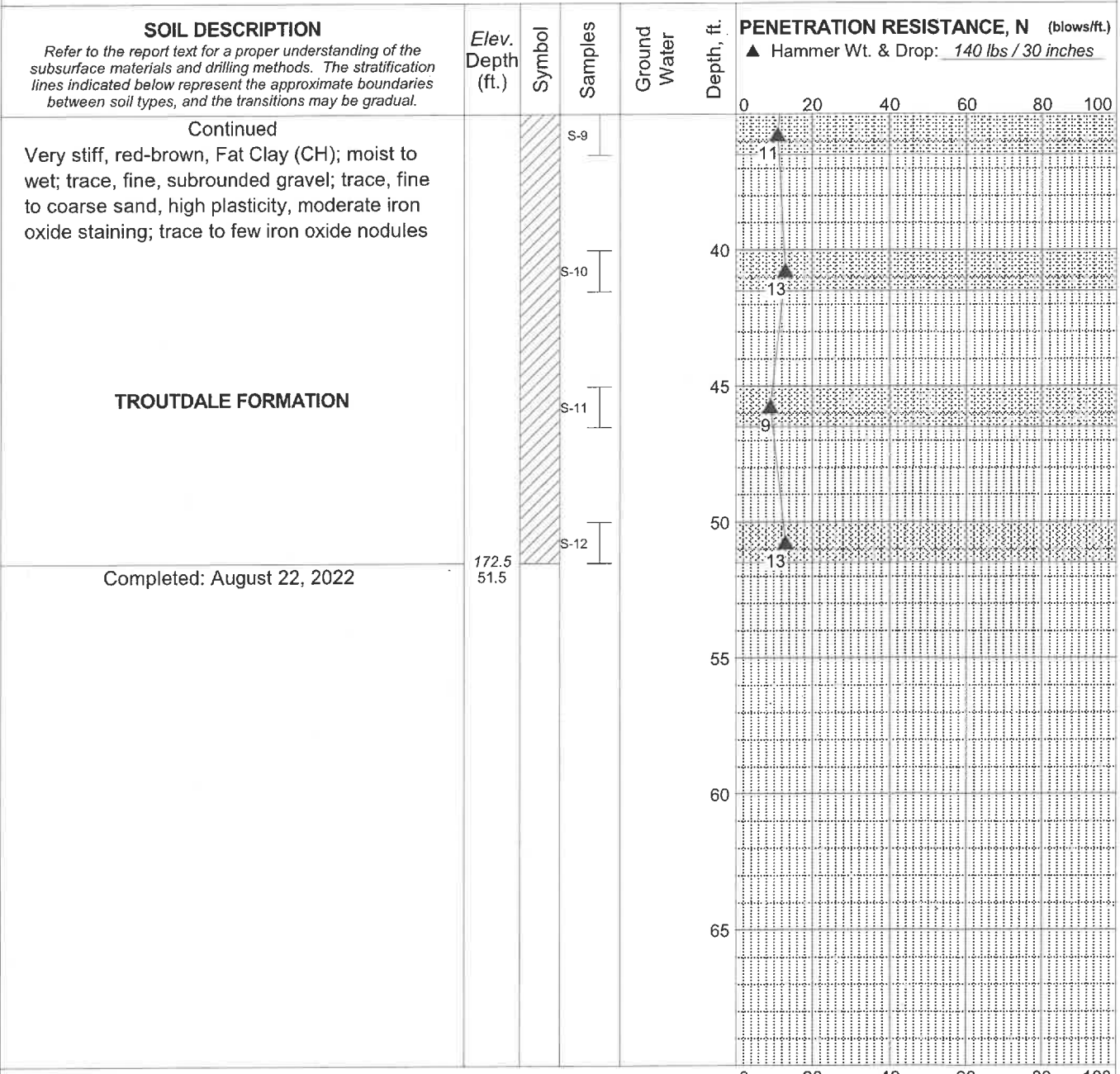

**LEGEND**

Standard Penetration Test	Groundwater Level ATD
3" O.D. Shelby Tube	Recovery (%)
	% Fines (<0.075mm)
	% Water Content
	Plastic Limit  Liquid Limit

- NOTES**
1. Refer to KEY for explanation of symbols, codes, abbreviations, and definitions.
  2. Groundwater level, if indicated above, is for the date specified and may vary.
  3. Group symbol is based on visual-manual identification and selected lab testing.
  4. The hole location and elevation should be considered approximate.

PGE Memorial Substation  
Wilsonville, Oregon

**LOG OF BORING B-01**

November 2022 109680

<b>SHANNON &amp; WILSON, INC.</b> Geotechnical and Environmental Consultants	<b>FIG. B2</b> Sheet 2 of 2
---	--------------------------------

MASTER\_LOG\_E 109680.GPJ SW2013\LIBRARY\PD\X.GLB SHANWIL\_PDX.GDT 11/15/22 Log: SCS Rev: CKS Typ: VCB



Total Depth: 31 ft.	Northing: ~ 611,084 ft.	Drilling Method: Mud Rotary	Hole Diam.: 5 in.
Top Elevation: ~ 221 ft.	Easting: ~ 7,618,755 ft.	Drilling Company: Western States	Rod Type: NWJ
Vert. Datum: NAVD88	Station: ~	Drill Rig Equipment: CME-75 Truck Rig #1	Hammer Type: Automatic
Horiz. Datum: OR83-NIF	Offset: ~	Other Comments: Hammer Efficiency = 81.4%	

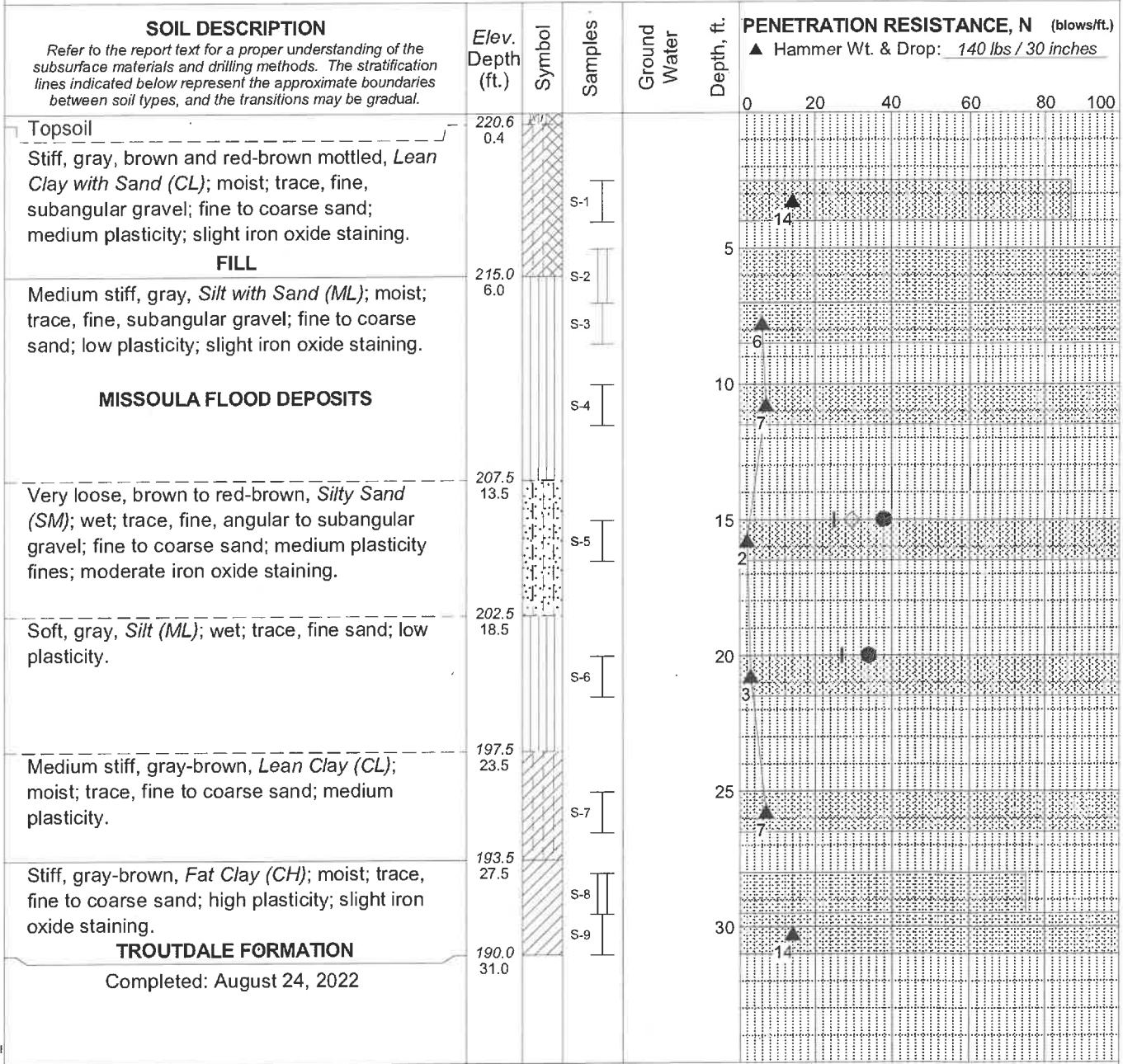

MASTER\_LOG\_E\_109680.GPJ SW2013\LIBRARY\PD\X.GLB SHANWIL\_PDX.GDT 11/15/22  
 Log: VCB Rev: CKS Typ: KJW

**LEGEND**

- [Symbol] Standard Penetration Test
- [Symbol] 3" O.D. Shelby Tube

[Symbol] Recovery (%)  
 [Symbol] % Fines (<0.075mm)  
 [Symbol] % Water Content  
 Plastic Limit [Symbol] Liquid Limit

- NOTES**
1. Refer to KEY for explanation of symbols, codes, abbreviations, and definitions.
  2. Groundwater level, if indicated above, is for the date specified and may vary.
  3. Group symbol is based on visual-manual identification and selected lab testing.
  4. The hole location and elevation should be considered approximate.

PGE Memorial Substation  
Wilsonville, Oregon

## LOG OF BORING B-02

November 2022
109680

**SHANNON & WILSON, INC.**  
Geotechnical and Environmental Consultants
**FIG. B3**

Total Depth: 101.5 ft. Northing: ~ 610,957 ft. Drilling Method: Mud Rotary Hole Diam.: 5 in.  
 Top Elevation: ~ 225 ft. Easting: ~ 7,618,894 ft. Drilling Company: Western States Rod Type: NWJ  
 Vert. Datum: NAVD88 Station: ~ Drill Rig Equipment: CME-75 Truck Rig #1 Hammer Type: Automatic  
 Horiz. Datum: OR83-NIF Offset: ~ Other Comments: Hammer Efficiency = 81.4%

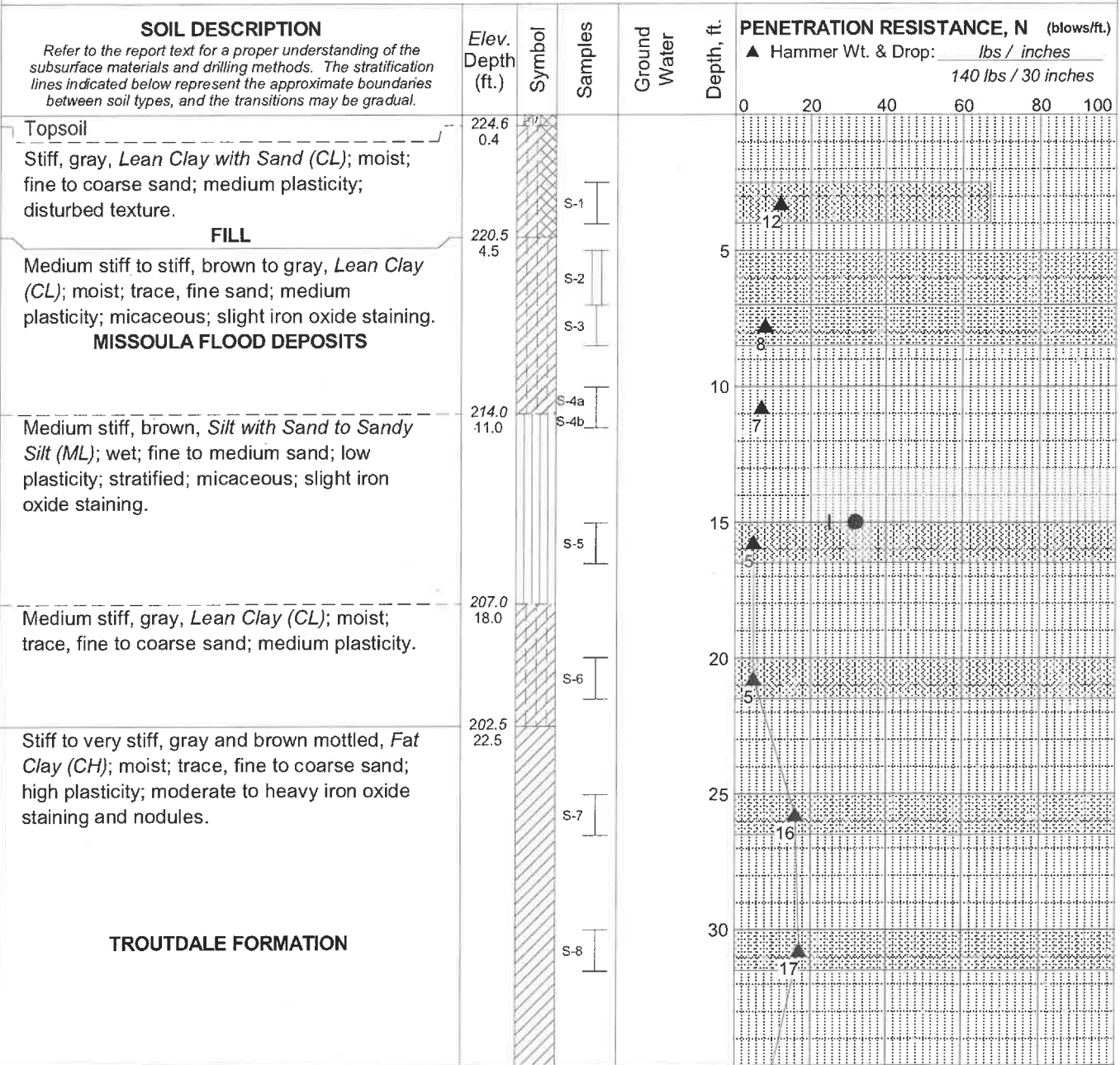

CONTINUED NEXT SHEET

**LEGEND**

- [Symbol] Standard Penetration Test
- [Symbol] 3" O.D. Shelby Tube

**NOTES**

1. Refer to KEY for explanation of symbols, codes, abbreviations, and definitions.
2. Groundwater level, if indicated above, is for the date specified and may vary.
3. Group symbol is based on visual-manual identification and selected lab testing.
4. The hole location and elevation should be considered approximate.

PGE Memorial Substation  
 Wilsonville, Oregon

**LOG OF BORING B-03**

November 2022

109680

**SHANNON & WILSON, INC.**  
 Geotechnical and Environmental Consultants

**FIG. B4**  
 Sheet 1 of 3

MASTER\_LOG\_E\_109680.GPJ SW2013\LIBRARY\PD\X\_GLB\_SHANWIL\_PDX\_GDT\_11/15/22 Logr. SCS Rev. CKS Typ. VCB



Total Depth: 101.5 ft.	Northing: ~ 610,957 ft.	Drilling Method: Mud Rotary	Hole Diam.: 5 in.
Top Elevation: ~ 225 ft.	Easting: ~ 7,618,894 ft.	Drilling Company: Western States	Rod Type: NWJ
Vert. Datum: NAVD88	Station: ~	Drill Rig Equipment: CME-75 Truck Rig #1	Hammer Type: Automatic
Horiz. Datum: OR83-NIF	Offset: ~	Other Comments: Hammer Efficiency = 81.4%	

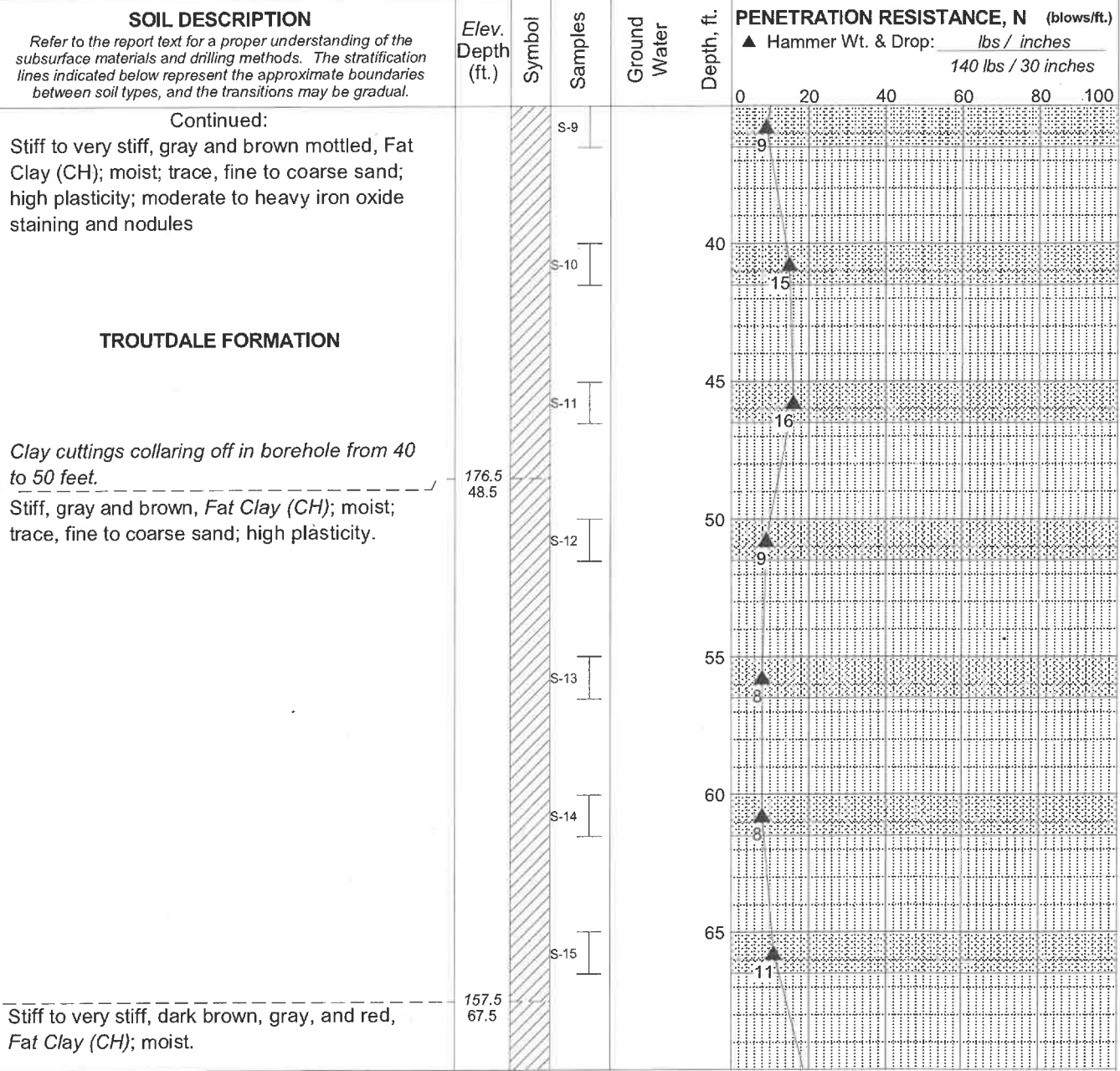

CONTINUED NEXT SHEET

**LEGEND**

- ⌈ Standard Penetration Test
- ⌈ 3" O.D. Shelby Tube

**NOTES**

1. Refer to KEY for explanation of symbols, codes, abbreviations, and definitions.
2. Groundwater level, if indicated above, is for the date specified and may vary.
3. Group symbol is based on visual-manual identification and selected lab testing.
4. The hole location and elevation should be considered approximate.

- ▣ Recovery (%)
- % Water Content
- Plastic Limit
- Liquid Limit

PGE Memorial Substation  
Wilsonville, Oregon

**LOG OF BORING B-03**

November 2022

109680

**SHANNON & WILSON, INC.**  
Geotechnical and Environmental Consultants

**FIG. B4**  
Sheet 2 of 3

MASTER\_LOG\_E\_109680.GPJ SW2013\LIBRARY\PD\X.GLB SHANWIL\_PDX.GDT 11/15/22 Log: SCS Rev: CKS Typ: VCB

Total Depth: 101.5 ft.	Northing: ~ 610,957 ft.	Drilling Method: Mud Rotary	Hole Diam.: 5 in.
Top Elevation: ~ 225 ft.	Easting: ~ 7,618,894 ft.	Drilling Company: Western States	Rod Type: NWJ
Vert. Datum: NAVD88	Station: ~	Drill Rig Equipment: CME-75 Truck Rig #1	Hammer Type: Automatic
Horiz. Datum: OR83-NIF	Offset: ~	Other Comments: Hammer Efficiency = 81.4%	

**SOIL DESCRIPTION**  
 Refer to the report text for a proper understanding of the subsurface materials and drilling methods. The stratification lines indicated below represent the approximate boundaries between soil types, and the transitions may be gradual.

Continued:  
 Stiff to very stiff, dark brown, gray, and red, Fat Clay (CH); moist; trace, fine to coarse sand; high plasticity; moderate to heavy iron oxide staining and iron oxide nodules.

**TROUTDALE FORMATION**

Medium stiff to stiff, red and brown mottled, Fat Clay (CH); moist to wet; trace, fine to coarse sand; high plasticity; moderate iron oxide staining.

Completed: August 23, 2022

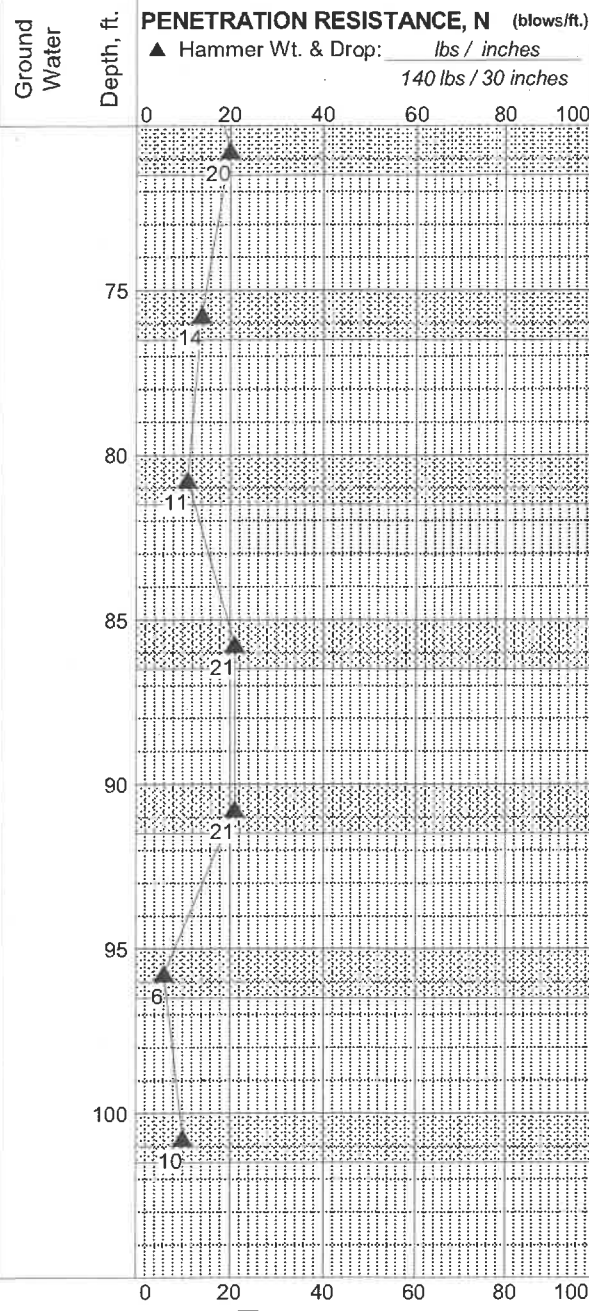
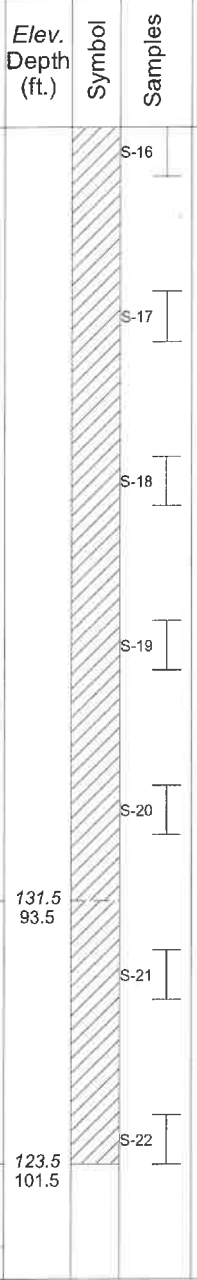

**LEGEND**  
 Standard Penetration Test  
 3" O.D. Shelby Tube

Recovery (%)  
% Water Content symbol"/> % Water Content  
 Plastic Limit ———— Liquid Limit

- NOTES**
1. Refer to KEY for explanation of symbols, codes, abbreviations, and definitions.
  2. Groundwater level, if indicated above, is for the date specified and may vary.
  3. Group symbol is based on visual-manual identification and selected lab testing.
  4. The hole location and elevation should be considered approximate.

PGE Memorial Substation  
 Wilsonville, Oregon

**LOG OF BORING B-03**

November 2022 109680

**SHANNON & WILSON, INC.**  
 Geotechnical and Environmental Consultants

**FIG. B4**  
 Sheet 3 of 3

MASTER\_LOG\_E\_109680.GPJ SW/2013/LIBRARY/PDX.GLB SHANWIL\_PDX.GDT 11/15/22 Log: SCS Rev: CKS Typ: VCB



Total Depth: 31.5 ft.	Northing: ~ 610,951 ft.	Drilling Method: Mud Rotary	Hole Diam.: 5 in.
Top Elevation: ~ 226 ft.	Easting: ~ 7,618,764 ft.	Drilling Company: Western States	Rod Type: NWJ
Vert. Datum: NAVD88	Station: ~	Drill Rig Equipment: CME-75 Truck Rig #1	Hammer Type: Automatic
Horiz. Datum: OR83-NIF	Offset: ~	Other Comments: Hammer Efficiency = 81.4%	

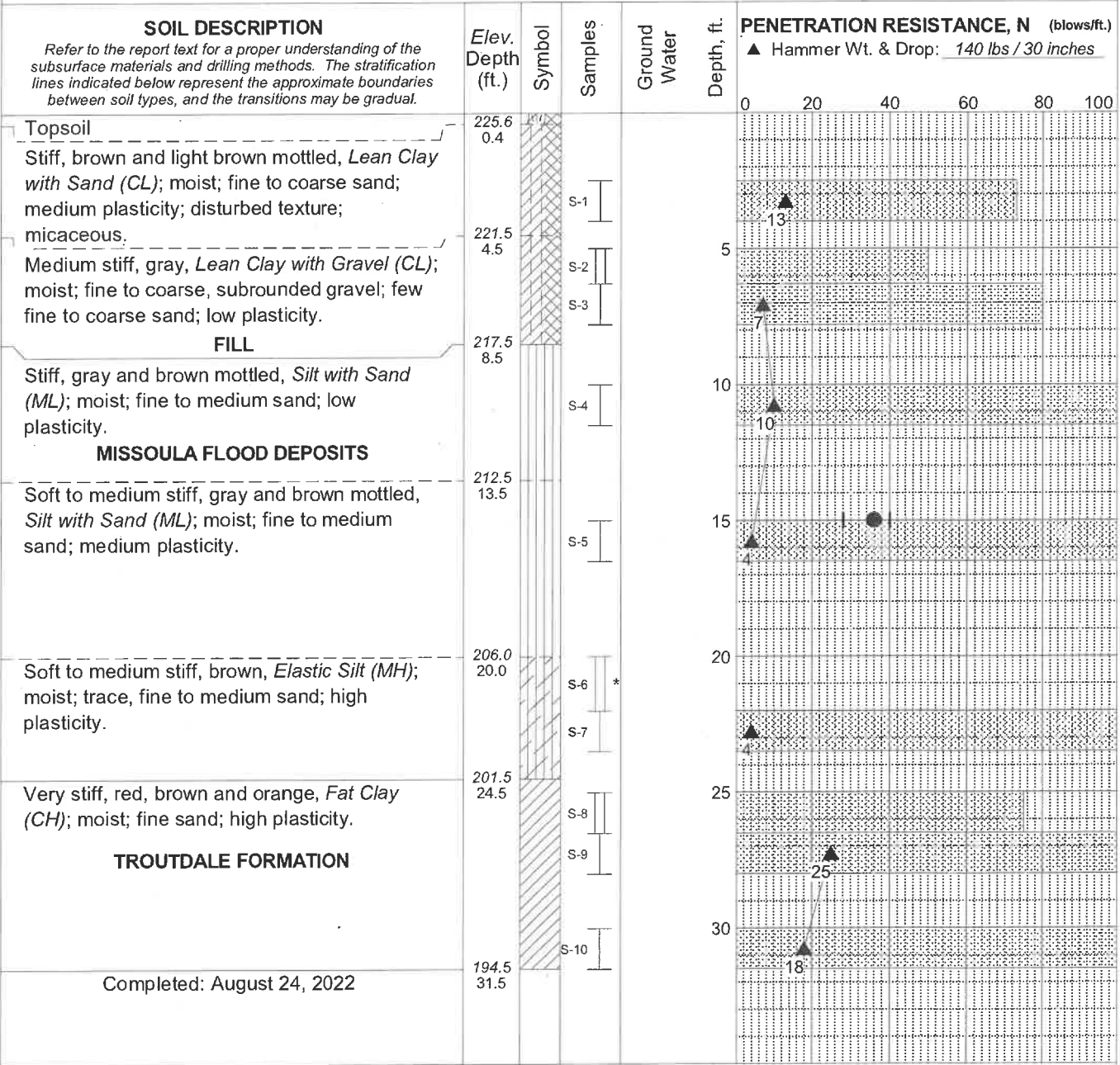

Log: VCB Rev: CKS Typ: KJW  
 MASTER\_LOG\_E\_109680.GPJ SW2013\LIBRARY\PD\X.GLB SHANWIL\_PDX.GDT 11/15/22

**LEGEND**

- \* Sample Not Recovered
- I Standard Penetration Test
- II 3" O.D. Shelby Tube

Recovery (%)  
 ● % Water Content  
 Plastic Limit — Liquid Limit

**NOTES**

1. Refer to KEY for explanation of symbols, codes, abbreviations, and definitions.
2. Groundwater level, if indicated above, is for the date specified and may vary.
3. Group symbol is based on visual-manual identification and selected lab testing.
4. The hole location and elevation should be considered approximate.

PGE Memorial Substation  
Wilsonville, Oregon

**LOG OF BORING B-04**

November 2022 109680

**SHANNON & WILSON, INC.**  
 Geotechnical and Environmental Consultants

**FIG. B5**



Total Depth: 36.5 ft.	Northing: ~ 610,781 ft.	Drilling Method: Mud Rotary	Hole Diam.: 5 in.
Top Elevation: ~ 223 ft.	Easting: ~ 7,618,920 ft.	Drilling Company: Western States	Rod Type: NWJ
Vert. Datum: NAVD88	Station: ~	Drill Rig Equipment: CME-75 Truck Rig #1	Hammer Type: Automatic
Horiz. Datum: OR83-NIF	Offset: ~	Other Comments: Hammer Efficiency = 81.4%	

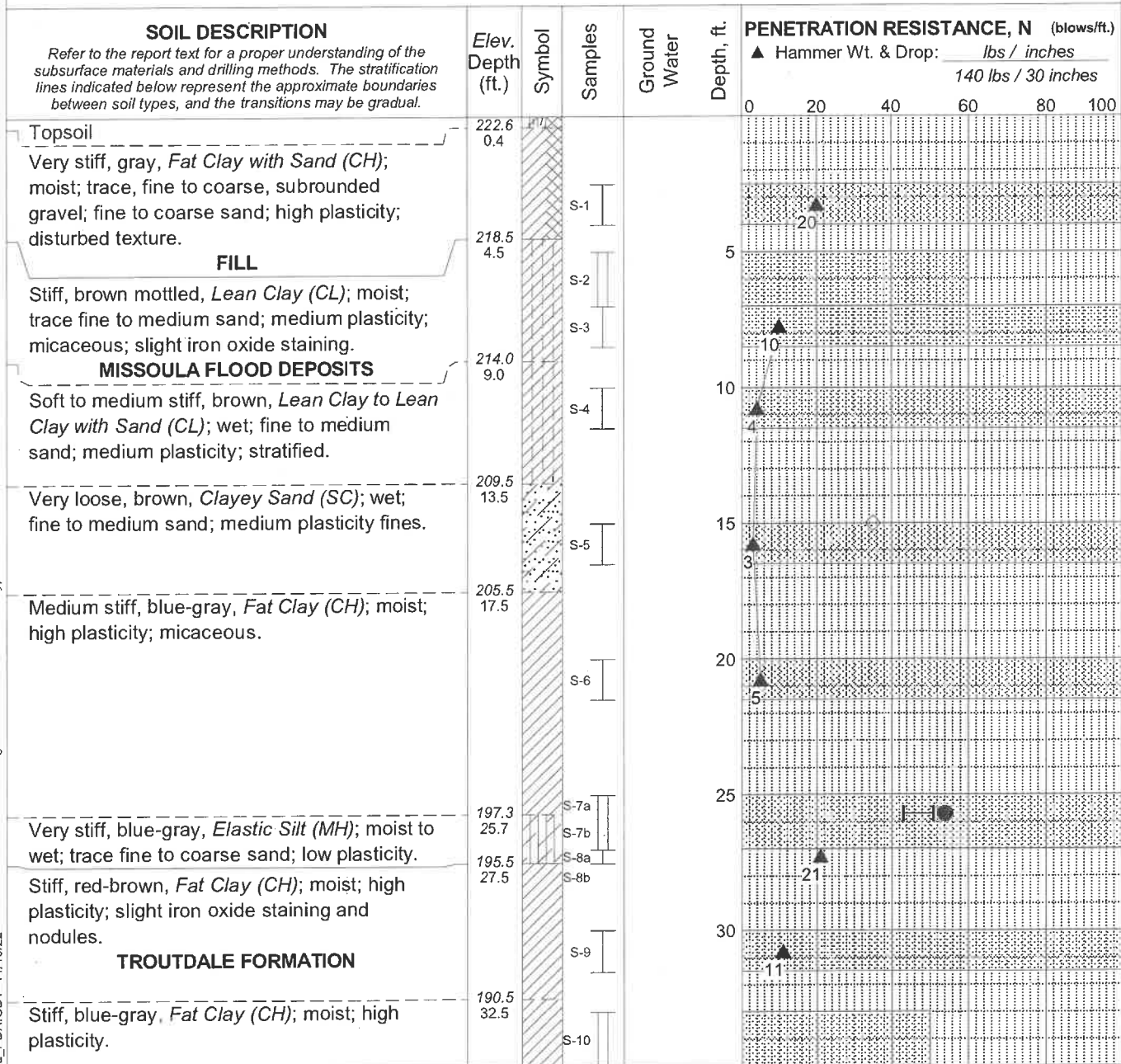

CONTINUED NEXT SHEET

**LEGEND**

- Standard Penetration Test
- 3" O.D. Shelby Tube

- Recovery (%)
- % Fines (<0.075mm)
- % Water Content
- Plastic Limit
- Liquid Limit

**NOTES**

1. Refer to KEY for explanation of symbols, codes, abbreviations, and definitions.
2. Groundwater level, if indicated above, is for the date specified and may vary.
3. Group symbol is based on visual-manual identification and selected lab testing.
4. The hole location and elevation should be considered approximate.

PGE Memorial Substation  
Wilsonville, Oregon

**LOG OF BORING B-05**

November 2022

109680

**SHANNON & WILSON, INC.**  
Geotechnical and Environmental Consultants

**FIG. B6**  
Sheet 1 of 2

MASTER\_LOG\_E\_109680.GPJ\_SW2013LIBRARYPDX.GLB\_SHANWIL\_PDX.GDT\_11/15/22 Log: SCS Rev: CKS Typ: VCB

Total Depth: 36.5 ft.	Northing: ~ 610,781 ft.	Drilling Method: Mud Rotary	Hole Diam.: 5 in.
Top Elevation: ~ 223 ft.	Easting: ~ 7,618,920 ft.	Drilling Company: Western States	Rod Type: NWJ
Vert. Datum: NAVD88	Station: ~	Drill Rig Equipment: CME-75 Truck Rig #1	Hammer Type: Automatic
Horiz. Datum: OR83-NIF	Offset: ~	Other Comments: Hammer Efficiency = 81.4%	

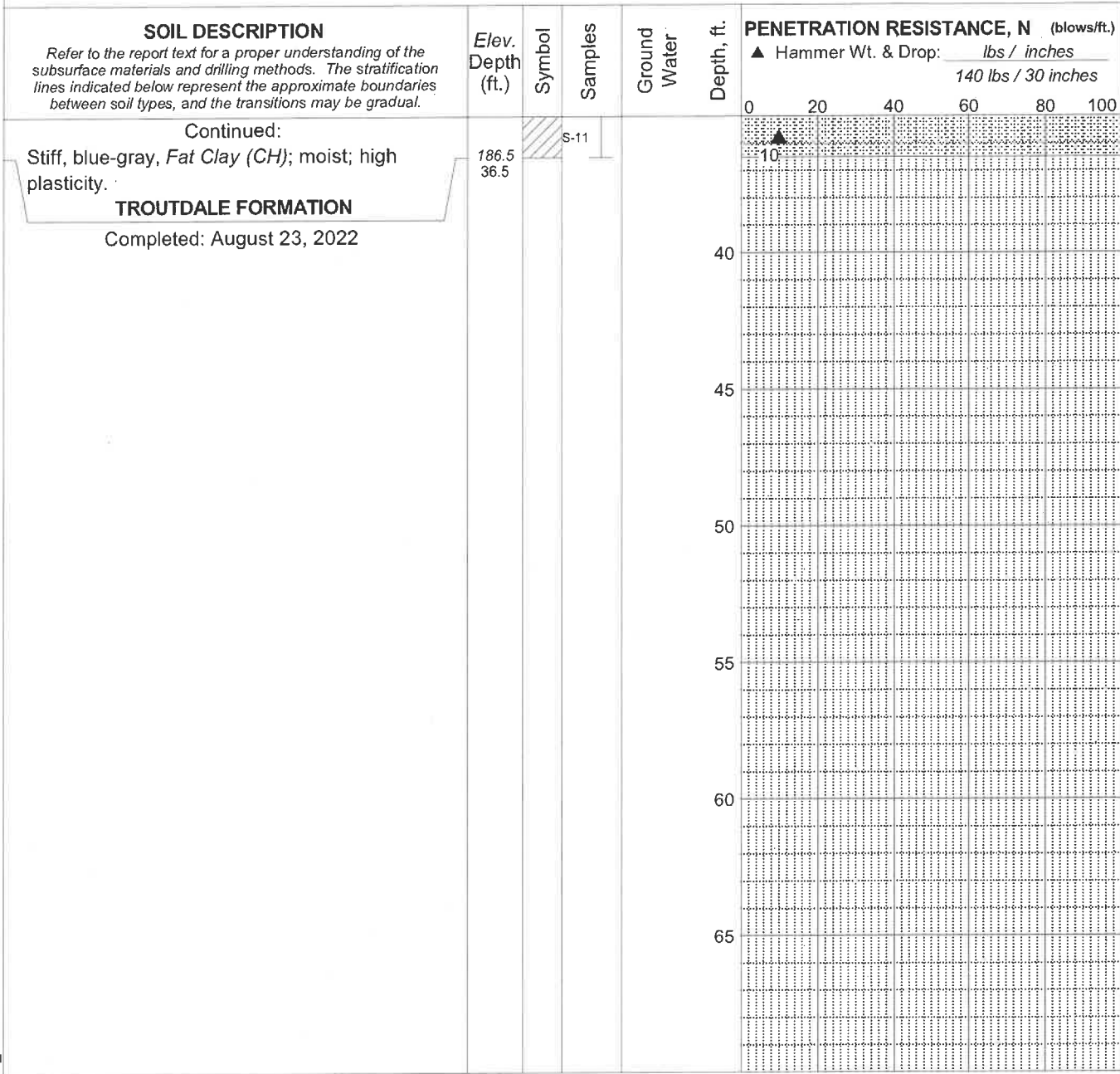

Log: SCS Rev: CKS Typ: YCB  
 MASTER\_LOG\_E\_109680.GPJ\_SW2013LIBRARYPDX.GLB\_SHANWIL\_PDX.GDT\_11/15/22

**LEGEND**

Standard Penetration Test

3" O.D. Shelby Tube

Recovery (%)

% Fines (<0.075mm)

% Water Content

Plastic Limit Liquid Limit

- NOTES**
1. Refer to KEY for explanation of symbols, codes, abbreviations, and definitions.
  2. Groundwater level, if indicated-above, is for the date specified and may vary.
  3. Group symbol is based on visual-manual identification and selected lab testing.
  4. The hole location and elevation should be considered approximate.

PGE Memorial Substation Wilsonville, Oregon	
<b>LOG OF BORING B-05</b>	
November 2022	109680
<b>SHANNON &amp; WILSON, INC.</b> Geotechnical and Environmental Consultants	<b>FIG. B6</b> Sheet 2 of 2



Total Depth: 56.5 ft.	Northing: ~ 610,813 ft.	Drilling Method: Mud Rotary	Hole Diam.: 5 in.
Top Elevation: ~ 227 ft.	Easting: ~ 7,618,766 ft.	Drilling Company: Western States	Rod Type: NWJ
Vert. Datum: NAVD88	Station: ~	Drill Rig Equipment: CME-75 Truck Rig #1	Hammer Type: Automatic
Horiz. Datum: OR83-NIF	Offset: ~	Other Comments: Hammer Efficiency = 81.4%	

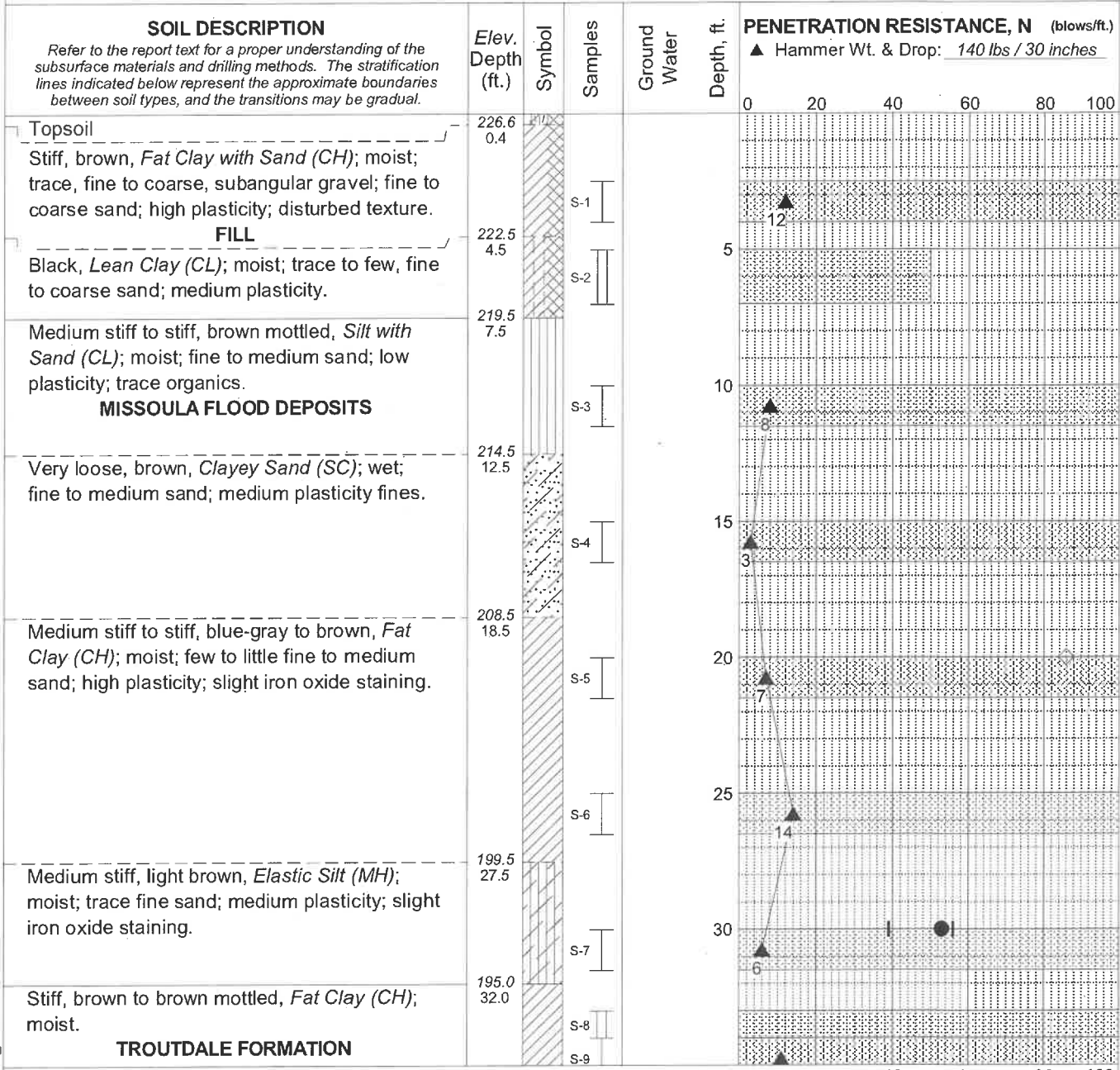

Log: SCS Rev: CKS Typ: VCB  
 MASTER\_LOG\_E\_109680.GPJ SW2013LIBRARYPDX.GLB SHANWIL\_PDX.GDT 11/15/22

CONTINUED NEXT SHEET

**LEGEND**

- [Symbol] Standard Penetration Test
- [Symbol] 3" O.D. Shelby Tube

- [Symbol] Recovery (%)
- [Symbol] % Fines (<0.075mm)
- [Symbol] % Water Content
- Plastic Limit [Symbol]
- Liquid Limit [Symbol]

**NOTES**

1. Refer to KEY for explanation of symbols, codes, abbreviations, and definitions.
2. Groundwater level, if indicated above, is for the date specified and may vary.
3. Group symbol is based on visual-manual identification and selected lab testing.
4. The hole location and elevation should be considered approximate.

PGE Memorial Substation  
Wilsonville, Oregon

**LOG OF BORING B-06**

November 2022 109680

<b>SHANNON &amp; WILSON, INC.</b> Geotechnical and Environmental Consultants	<b>FIG. B7</b> Sheet 1 of 2
---	--------------------------------

Total Depth: <u>56.5 ft.</u>	Northing: <u>~ 610,813 ft.</u>	Drilling Method: <u>Mud Rotary</u>	Hole Diam.: <u>5 in.</u>
Top Elevation: <u>~ 227 ft.</u>	Easting: <u>~ 7,618,766 ft.</u>	Drilling Company: <u>Western States</u>	Rod Type: <u>NWJ</u>
Vert. Datum: <u>NAVD88</u>	Station: <u>~</u>	Drill Rig Equipment: <u>CME-75 Truck Rig #1</u>	Hammer Type: <u>Automatic</u>
Horiz. Datum: <u>OR83-NIF</u>	Offset: <u>~</u>	Other Comments: <u>Hammer Efficiency = 81.4%</u>	

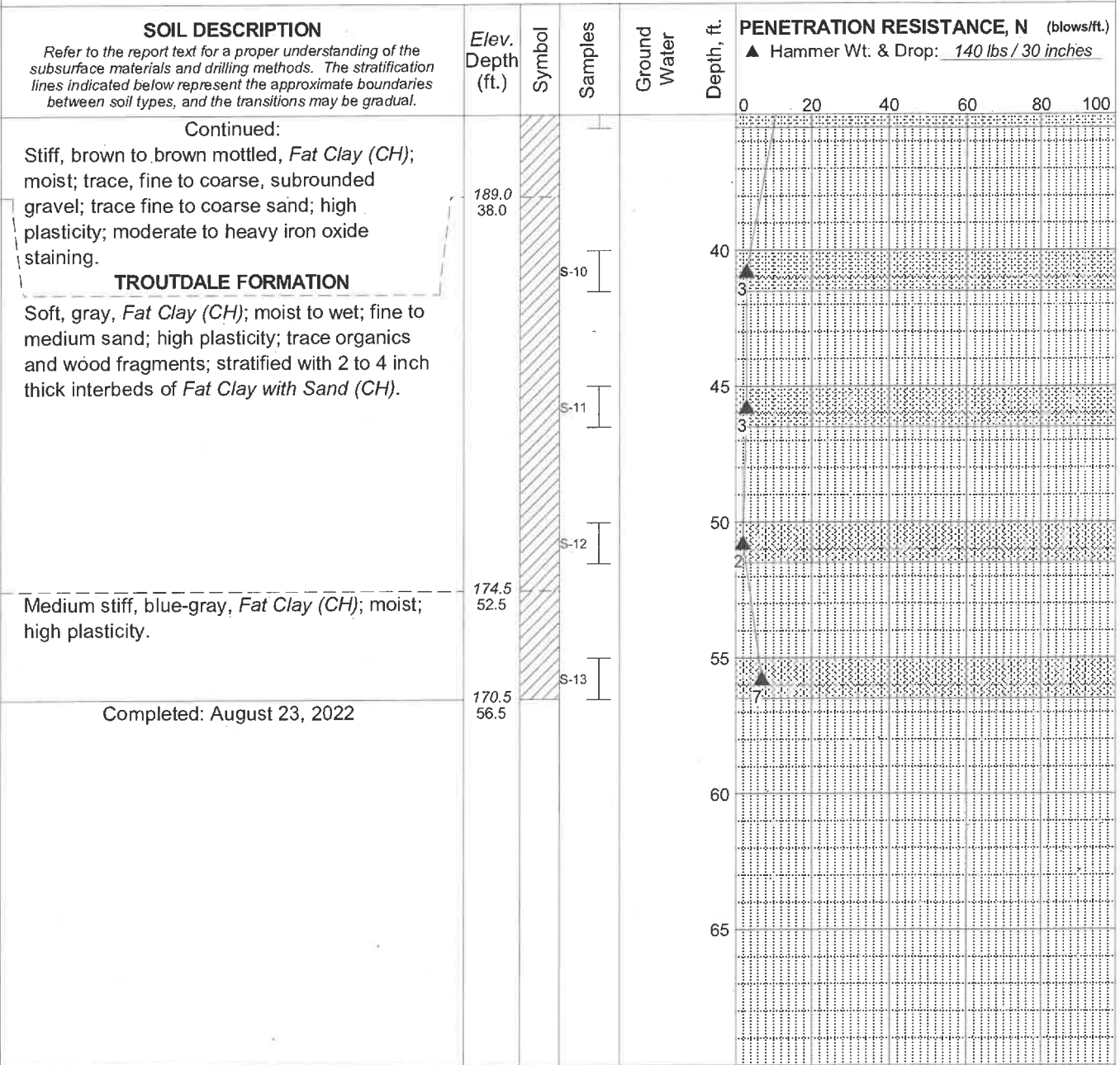

Log: SCS    Rev: CKS    Typ: VCB    11/15/22    SHANNON & WILSON, INC.

**LEGEND**

[Symbol]	Standard Penetration Test	[Symbol]	Recovery (%)
[Symbol]	3" O.D. Shelby Tube	[Symbol]	% Fines (<0.075mm)
		[Symbol]	% Water Content
		[Symbol]	Plastic Limit
		[Symbol]	Liquid Limit

- NOTES**
1. Refer to KEY for explanation of symbols, codes, abbreviations, and definitions.
  2. Groundwater level, if indicated above, is for the date specified and may vary.
  3. Group symbol is based on visual-manual identification and selected lab testing.
  4. The hole location and elevation should be considered approximate.

PGE Memorial Substation  
Wilsonville, Oregon

**LOG OF BORING B-06**

November 2022 109680

<b>SHANNON &amp; WILSON, INC.</b> Geotechnical and Environmental Consultants	<b>FIG. B7</b> Sheet 2 of 2
---	--------------------------------



Appendix C

# Laboratory Test Results

## CONTENTS

C.1 General.....1

    C.1.1 Soil Testing.....1

        C.1.1.1 Moisture (Natural Water) Content.....1

        C.1.1.2 Atterberg Limits.....1

        C.1.1.3 Particle-Size Analyses .....2

        C.1.1.4 Thermal Resistivity Testing.....2

## Figures

- Figure C1: Atterberg Limits Results
- Figure C2: Grain Size Distribution

## Attachments

- GeoTesting Express, Inc., Testing Results Report, dated September 28, 2022
- Geotherm USA, Inc. Thermal Analysis Report, dated September 12, 2022



## C.1 GENERAL

Soil samples obtained during the field explorations were described and identified in the field in general accordance with the Standard Practice for Description and Identification of Soils (Visual-Manual Procedure), ASTM D2488. The specific terminology used is presented on Appendix B, Figure B1. The samples were reviewed in the laboratory at Shannon & Wilson, Inc. The physical characteristics of the samples were noted, and the field descriptions and identifications were modified, where necessary, in accordance with terminology presented in Appendix B, Figure B1. Select samples were chosen for various laboratory tests. We refined our visual-manual soil descriptions and identifications based on the results of the laboratory tests using elements of the Standard Practice for Classification of Soils for Engineering Purposes (United Soil Classification System), ASTM D2487. The refined descriptions and identifications were then incorporated into the Logs of Borings, presented in Appendix B. Note that ASTM D2487 was not followed in full because it requires a suite of tests be performed to fully classify a single sample.

The soil testing program included Atterberg limits testing, natural moisture contents, particle-size analyses, and thermal resistivity testing. Laboratory testing including Atterberg limits testing, natural moisture contents and particle-size analysis was performed by GeoTesting Express, Inc. of Acton, Massachusetts. Thermal resistivity testing was performed by Geotherm USA, Inc. of Cypress, Texas. All test procedures were performed in accordance with applicable ASTM International standards or IEEE standards. Test procedures are summarized in the following paragraphs.

### C.1.1 Soil Testing

#### C.1.1.1 Moisture (Natural Water) Content

Natural moisture content determinations were performed in accordance with ASTM D2216, on selected soil samples. The natural moisture content is a measure of the amount of moisture in the soil at the time of exploration. It is defined as the ratio of the weight of water to the dry weight of the soil, expressed as a percentage. The results of moisture content determinations are presented in the Logs of Borings in Appendix B.

#### C.1.1.2 Atterberg Limits

Atterberg limits were determined for select samples in accordance with ASTM D4318. This analysis yields index parameters of the soil that are useful in soil identification, as well as in a number of analyses, including liquefaction analysis. An Atterberg limits test determines a soil's liquid limit (LL) and plastic limit (PL). These are the maximum and minimum



moisture contents at which the soil exhibits plastic behavior. A soil's plasticity index (PI) can be determined by subtracting PL from LL. The LL, PL, and PI of tested samples are presented on Figure C1, Atterberg Limits Results. The results of the Atterberg limits tests are also presented in the Logs of Borings in Appendix B. For the purposes of soil description, Shannon & Wilson uses the term nonplastic to refer to soils with a PI less than 4, low plasticity for soils with a PI range of 4 to 10, medium plasticity for soils with a PI range of 10 to 20, and high plasticity for soils with a PI greater than 20.

#### C.1.1.3 Particle-Size Analyses

Particle-size analysis was conducted on a select sample to determine its grain-size distribution. Grain size distribution was determined in accordance with D1140. For the sample, a wet sieve analysis was performed to determine the percentage (by weight) of sample passing the No. 200 (0.075 mm) sieve. For all tested samples, only the percentage of the sample passing the No. 200 (0.075mm) sieve was determined (ASTM D1140). Results of all particle-size analyses are presented on Figure C2, Grain Size Distribution. The percentage of each sample passing the No. 200 sieve is presented on the Logs of Borings in Appendix B.

#### C.1.1.4 Thermal Resistivity Testing

Thermal resistivity testing was performed on relatively undisturbed soil samples from each boring at the depth of 5 feet. For each sample, a series of thermal resistivity measurements are made in stages with moisture contents ranging from the "wet" to the "dry" condition. The thermal resistivity test also included the measurement of moisture content, density, and thermal dryout characterization. The tests were conducted in accordance with the IEEE standard 442-2017. Geotherm summarized their test methodology and results in a report which is included at the end of this appendix.

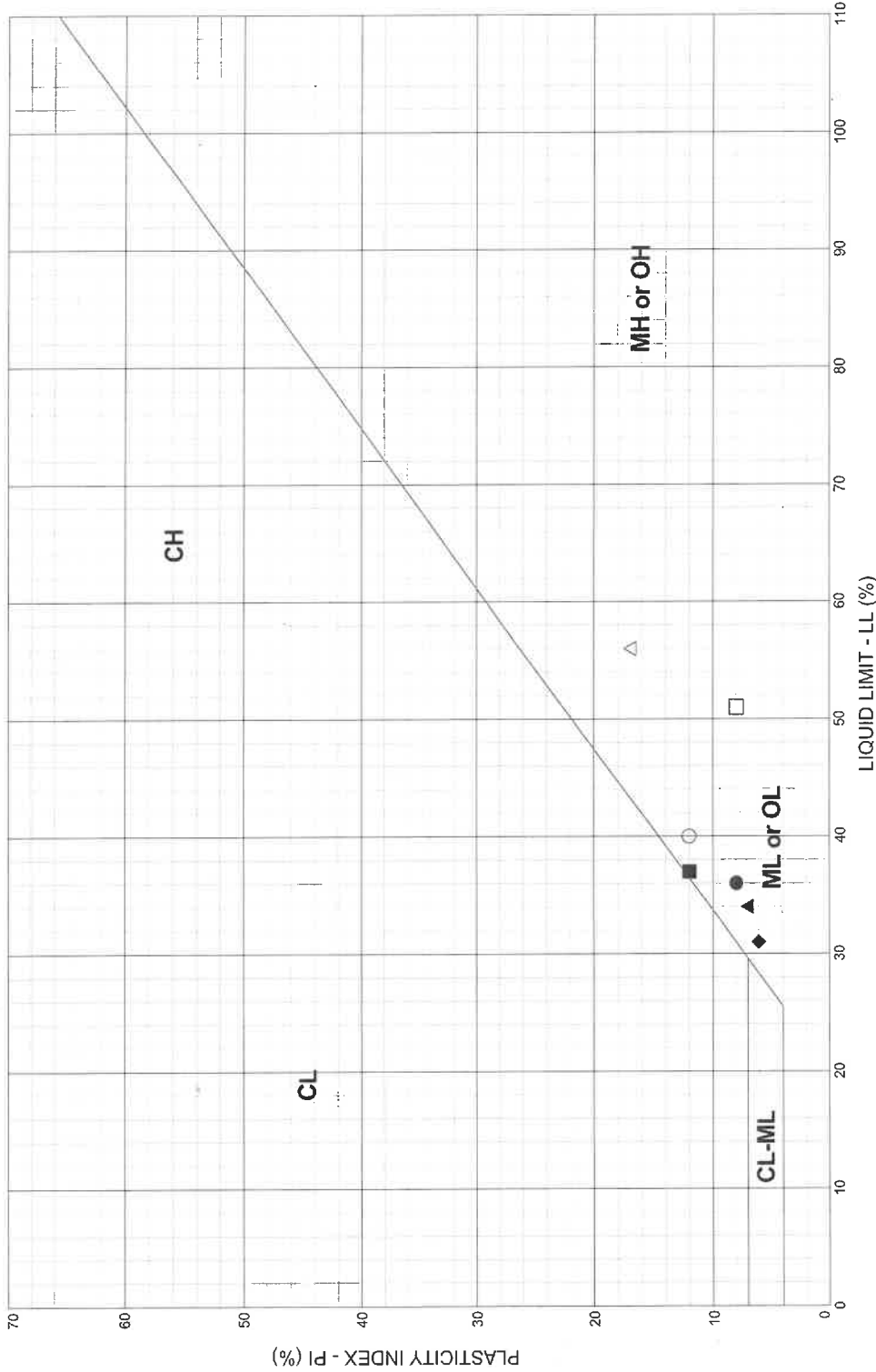

**NOTES**

- 1) Atterberg limits tests were performed in general accordance with ASTM D4318 unless otherwise noted in the report.
- 2) Group Name and Group Symbol are in accordance with ASTM D2488 and are refined in accordance with ASTM D2487 where appropriate laboratory tests are performed.
- 3) Plasticity adjectives used in sample descriptions correspond to plasticity index as follows:
  - Nonplastic (NP) (< 4%)
  - Low Plasticity (4 to 10%)
  - Medium Plasticity (10 to 20%)
  - High Plasticity (> 20%)

BORING AND SAMPLE NO.	DEPTH (feet)	GROUP SYMBOL <sup>2</sup>	GROUP NAME <sup>2</sup>	LL %	PL %	PI % <sup>3</sup>	NAT. W.C. %	FINES %
● B-01, S-5	15.0	ML	Sandy Silt	36	28	8	29	62
■ B-02, S-5	15.0	SM	Silty Sand	37	25	12	38	30
▲ B-02, S-6	20.0	ML	Silt	34	27	7	34	
◆ B-03, S-5	15.0	ML	Silt with Sand to Sandy Silt	31	25	6	32	
○ B-04, S-5	15.0	ML	Silt with Sand	40	28	12	36	
□ B-05, S-7b	25.7	MH	Elastic Silt	51	43	8	54	
△ B-06, S-7	30.0	MH	Elastic Silt	56	39	17	53	

PGE Memorial Substation  
Wilsonville, Oregon

**ATTERBERG LIMITS RESULTS**

November 2022 109680  
**SHANNON & WILSON, INC.**  
 Geotechnical and Environmental Consultants  
**FIG. C1**

**FIG. C1**

**NOTES:**

1) Sieve analyses were performed in general accordance with ASTM D6913, sieve with hydrometer analyses were performed in general accordance with ASTM D422, and amount finer than #200 sieve analyses were performed in general accordance with ASTM D1140 unless otherwise noted in the report.  
 2) Group Name and Group Symbol are in accordance with ASTM D2488 and are refined in accordance with ASTM D2487 where appropriate laboratory tests are performed.

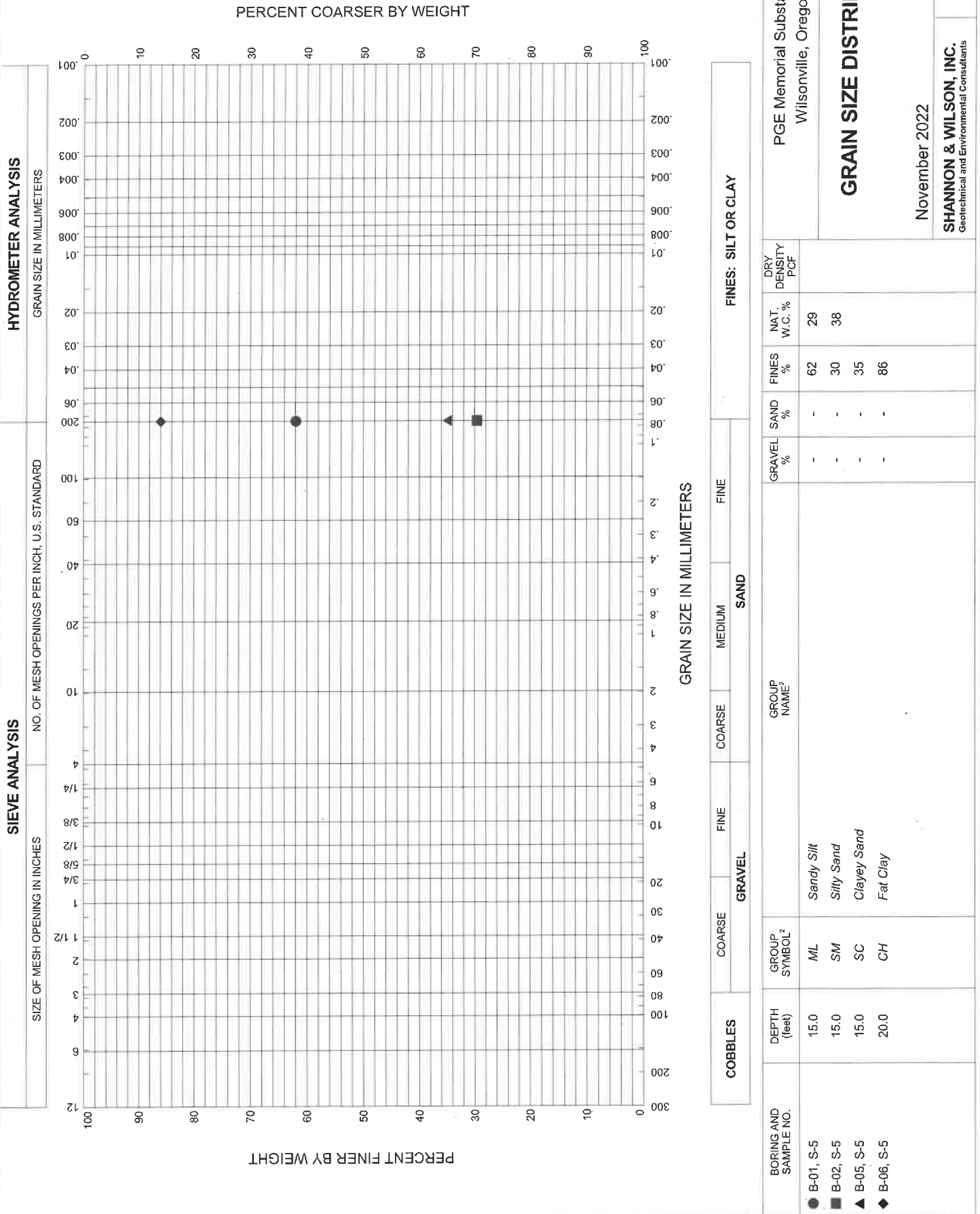

PGE Memorial Substation  
Wilsonville, Oregon

**GRAIN SIZE DISTRIBUTION**

November 2022      109680

**SHANNON & WILSON, INC.**  
Geotechnical and Environmental Consultants

**FIG. C2**

**FIG. C2**



Client:	Shannon & Wilson, Inc.		
Project:	PGE Memorial Substation		
Location:	Wilsonville, OR	Project No:	GTX-316148
Boring ID:	---	Sample Type:	---
Sample ID:	---	Test Date:	09/28/22
Depth :	---	Test Id:	686845
		Tested By:	ckg
		Checked By:	bfs

## Amount of Material Passing #200 Sieve - ASTM D1140

Boring ID	Sample ID	Depth	Visual Description	Fines, %
B-01	S-5	15-16.5	Moist, olive brown silt with sand	62.0
B-02	S-5	15-16.5	Moist, dark yellowish brown silty sand with gravel	29.6
B-05	S-5	15-16.5	Moist, dark yellowish brown silty sand	35.0
B-06	S-5	20-21.5	Moist, dark yellowish brown silt	86.0

Notes: Tests performed using Method B - washing using a wetting agent  
 Dry mass of test specimen was determined directly



Client: Shannon & Wilson, Inc.  
 Project: PGE Memorial Substation  
 Location: Wilsonville, OR  
 Project No: GTX-316148  
 Boring ID: B-01  
 Sample Type: tube  
 Tested By: ckg  
 Sample ID: S-5  
 Test Date: 09/28/22  
 Checked By: bfs  
 Depth: 15-16.5  
 Test Id: 686835  
 Test Comment: ---  
 Visual Description: Moist, olive brown silt with sand  
 Sample Comment: ---

## Atterberg Limits - ASTM D4318

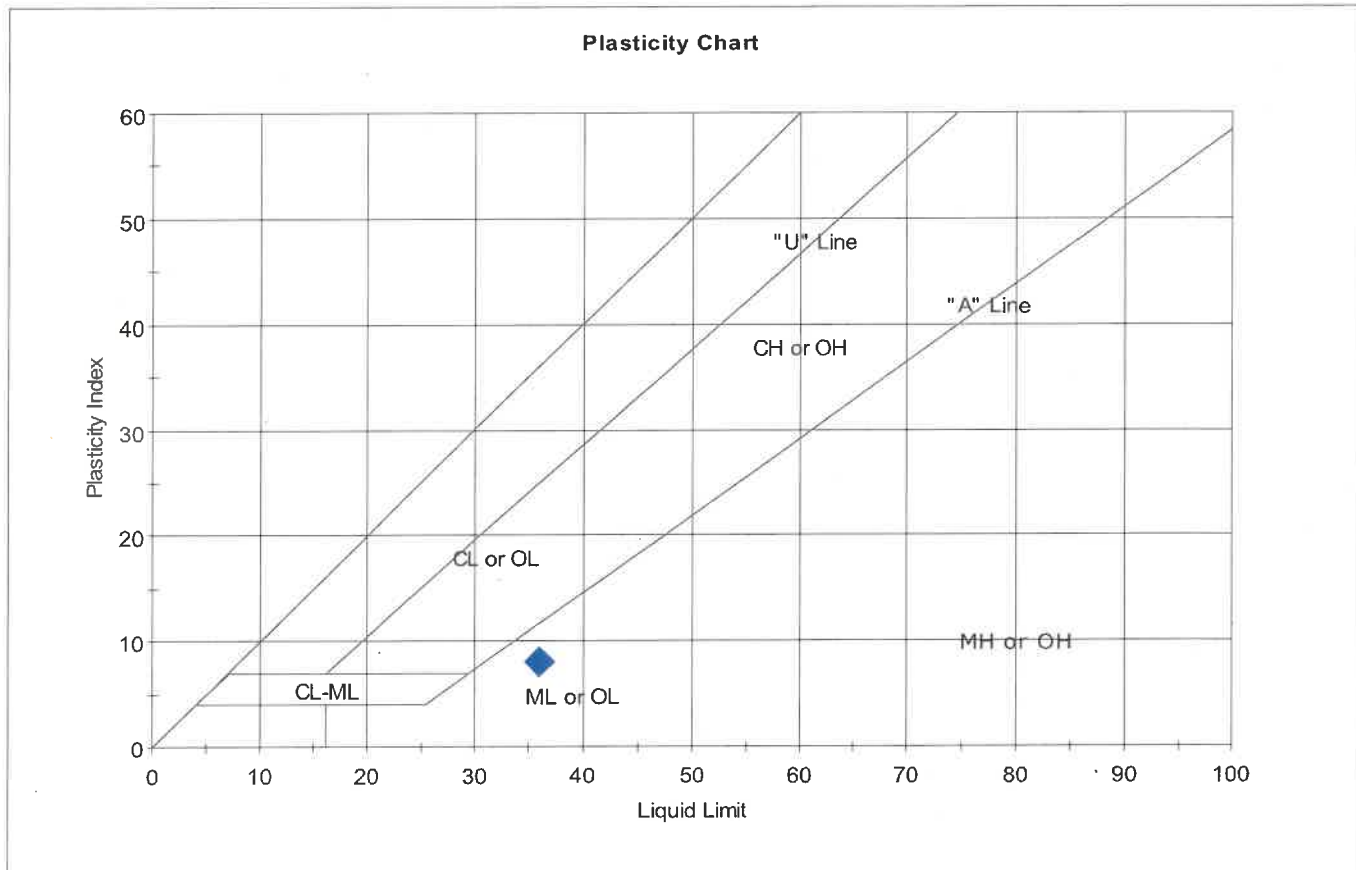

Symbol	Sample ID	Boring	Depth	Natural Moisture Content, %	Liquid Limit	Plastic Limit	Plasticity Index	Liquidity Index	Soil Classification
◆	S-5	B-01	15-16.5	29	36	28	8	0.2	

Sample Prepared using the WET method

Dry Strength: VERY HIGH

Dilatancy: SLOW

Toughness: LOW



Client: Shannon & Wilson, Inc.  
 Project: PGE Memorial Substation  
 Location: Wilsonville, OR  
 Project No: GTX-316148  
 Boring ID: B-02  
 Sample Type: tube  
 Tested By: ckg  
 Sample ID: S-5  
 Test Date: 09/28/22  
 Checked By: bfs  
 Depth: 15-16.5  
 Test Id: 686836  
 Test Comment: ---  
 Visual Description: Moist, dark yellowish brown silty sand with gravel  
 Sample Comment: ---

## Atterberg Limits - ASTM D4318

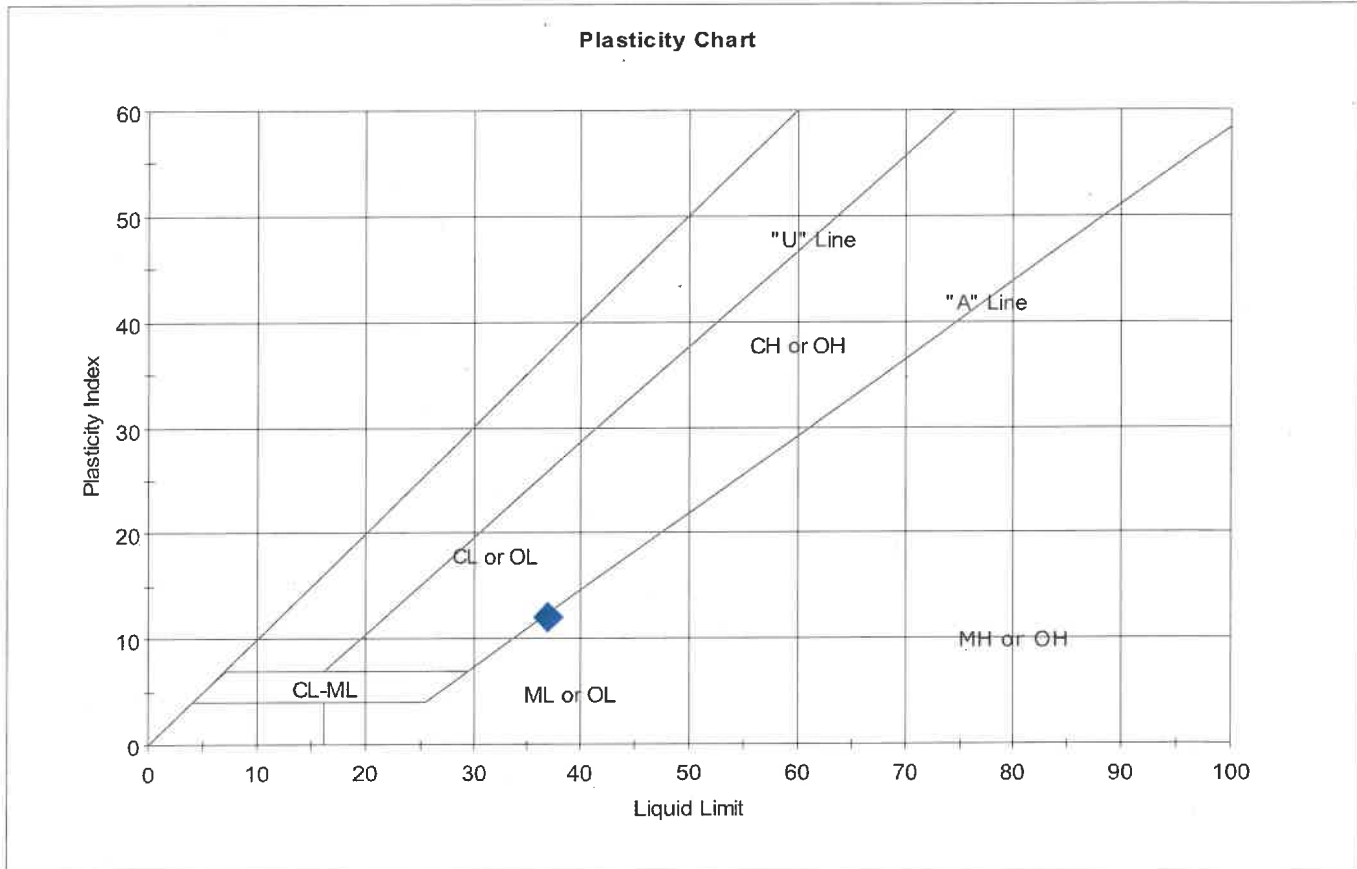

Symbol	Sample ID	Boring	Depth	Natural Moisture Content, %	Liquid Limit	Plastic Limit	Plasticity Index	Liquidity Index	Soil Classification
◆	S-5	B-02	15-16.5	38	37	25	12	1.1	

Sample Prepared using the WET method

Dry Strength: VERY HIGH

Dilatancy: SLOW

Toughness: LOW





Client: Shannon & Wilson, Inc.  
 Project: PGE Memorial Substation  
 Location: Wilsonville, OR  
 Project No: GTX-316148  
 Boring ID: B-02  
 Sample Type: tube  
 Tested By: ckg  
 Sample ID: S-6  
 Test Date: 09/28/22  
 Checked By: bfs  
 Depth: 20-21.5  
 Test Id: 686837  
 Test Comment: ---  
 Visual Description: Moist, dark gray silt  
 Sample Comment: ---

## Atterberg Limits - ASTM D4318

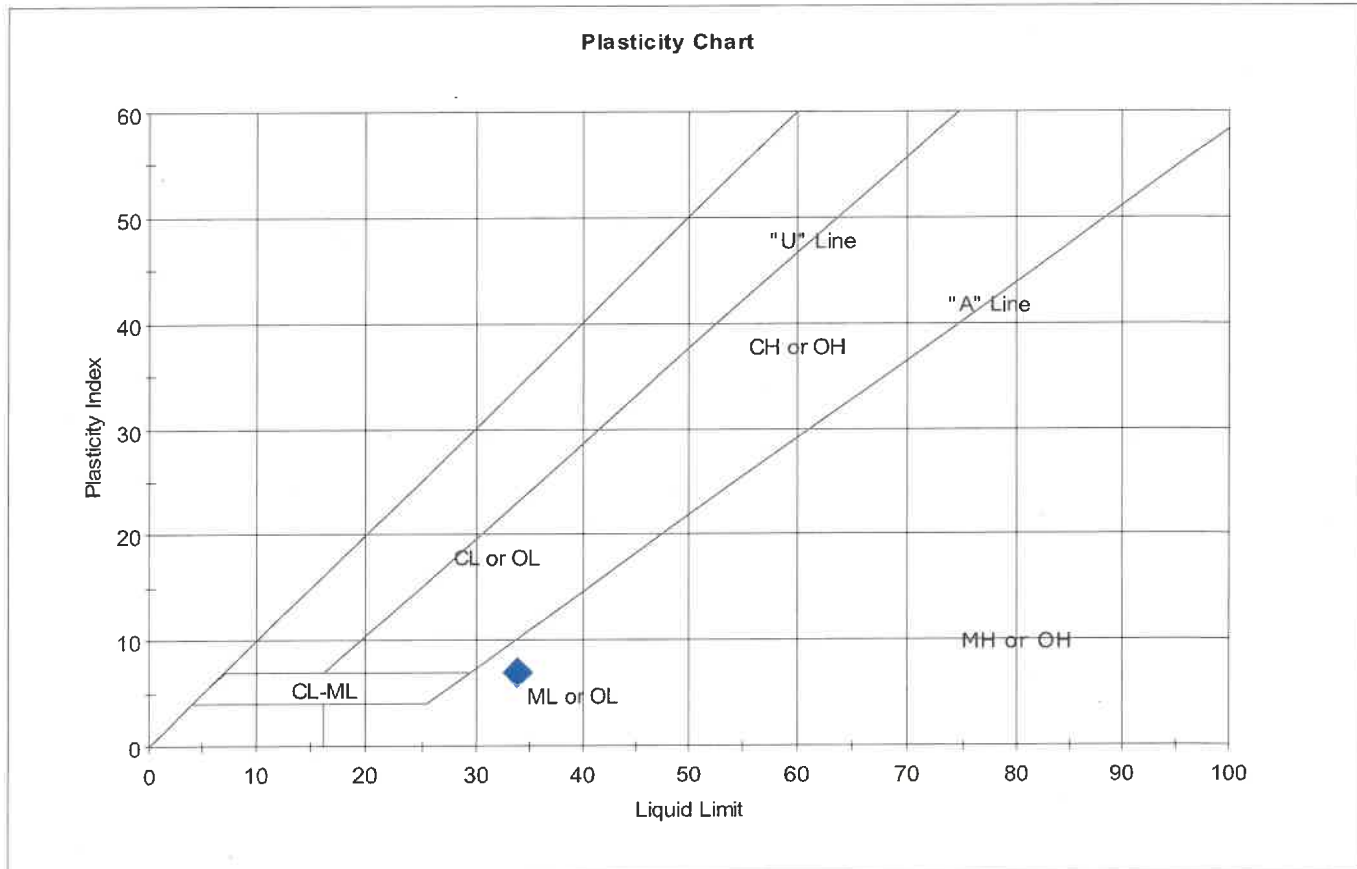

Symbol	Sample ID	Boring	Depth	Natural Moisture Content, %	Liquid Limit	Plastic Limit	Plasticity Index	Liquidity Index	Soil Classification
◆	S-6	B-02	20-21.5	34	34	27	7	1	

Sample Prepared using the WET method

Dry Strength: VERY HIGH

Dilatancy: SLOW

Toughness: LOW



Client:	Shannon & Wilson, Inc.		
Project:	PGE Memorial Substation		
Location:	Wilsonville, OR	Project No:	GTX-316148
Boring ID:	B-03	Sample Type:	tube
Sample ID:	S-5	Test Date:	09/28/22
Depth :	15-16.5	Test Id:	686838
Test Comment:	---		
Visual Description:	Moist, dark yellowish brown silt		
Sample Comment:	---		

## Atterberg Limits - ASTM D4318

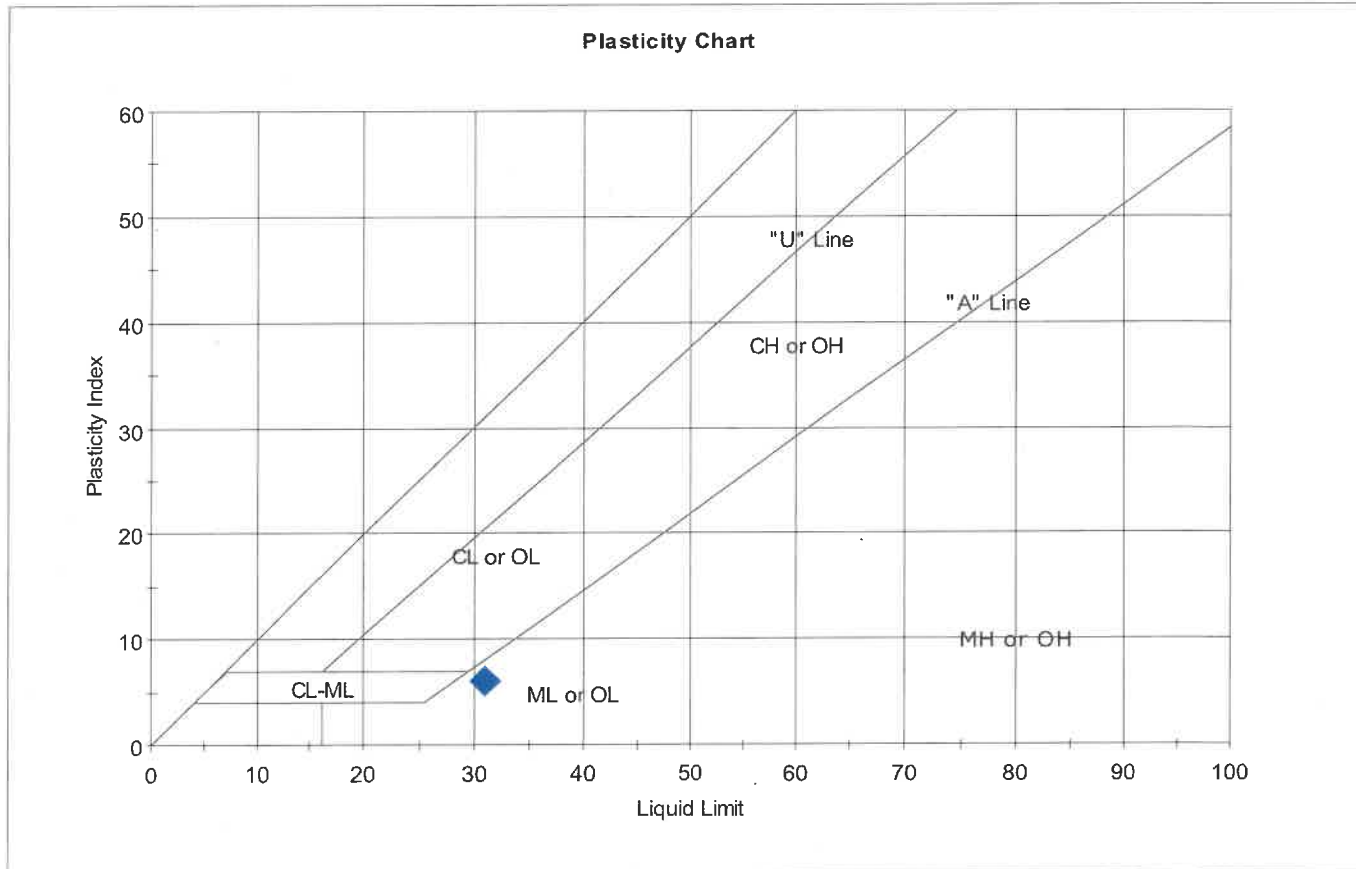

Symbol	Sample ID	Boring	Depth	Natural Moisture Content, %	Liquid Limit	Plastic Limit	Plasticity Index	Liquidity Index	Soil Classification
◆	S-5	B-03	15-16.5	32	31	.25	6	1.2	

Sample Prepared using the WET method

Dry Strength: VERY HIGH

Dilatancy: SLOW

Toughness: LOW



Client:	Shannon & Wilson, Inc.		
Project:	PGE Memorial Substation		
Location:	Wilsonville, OR	Project No:	GTX-316148
Boring ID:	B-04	Sample Type:	tube
Sample ID:	S-5	Test Date:	09/28/22
Depth:	15-16.5	Test Id:	686839
Test Comment:	---		
Visual Description:	Moist, dark yellowish brown silt		
Sample Comment:	---		

## Atterberg Limits - ASTM D4318

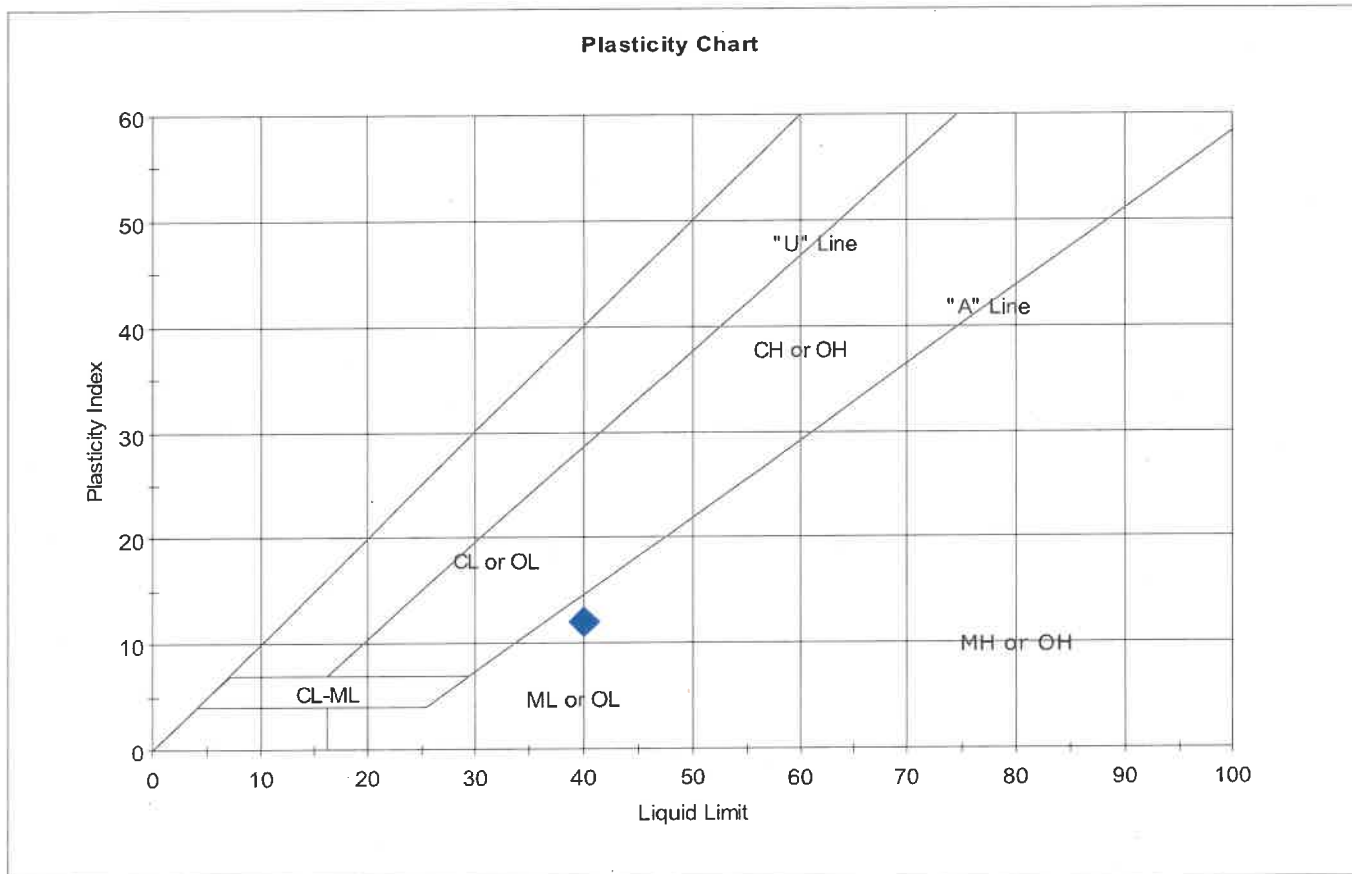

Symbol	Sample ID	Boring	Depth	Natural Moisture Content, %	Liquid Limit	Plastic Limit	Plasticity Index	Liquidity Index	Soil Classification
◆	S-5	B-04	15-16.5	36	40	28	12	0.7	

Sample Prepared using the WET method

Dry Strength: VERY HIGH

Dilatancy: SLOW

Toughness: LOW



Client:	Shannon & Wilson, Inc.		
Project:	PGE Memorial Substation		
Location:	Wilsonville, OR	Project No:	GTX-316148
Boring ID:	B-05	Sample Type:	tube
Sample ID:	S-7	Test Date:	09/28/22
Depth:	25.7-27	Test Id:	686840
Test Comment:	---		
Visual Description:	Moist, dark grayish brown silt		
Sample Comment:	---		

## Atterberg Limits - ASTM D4318

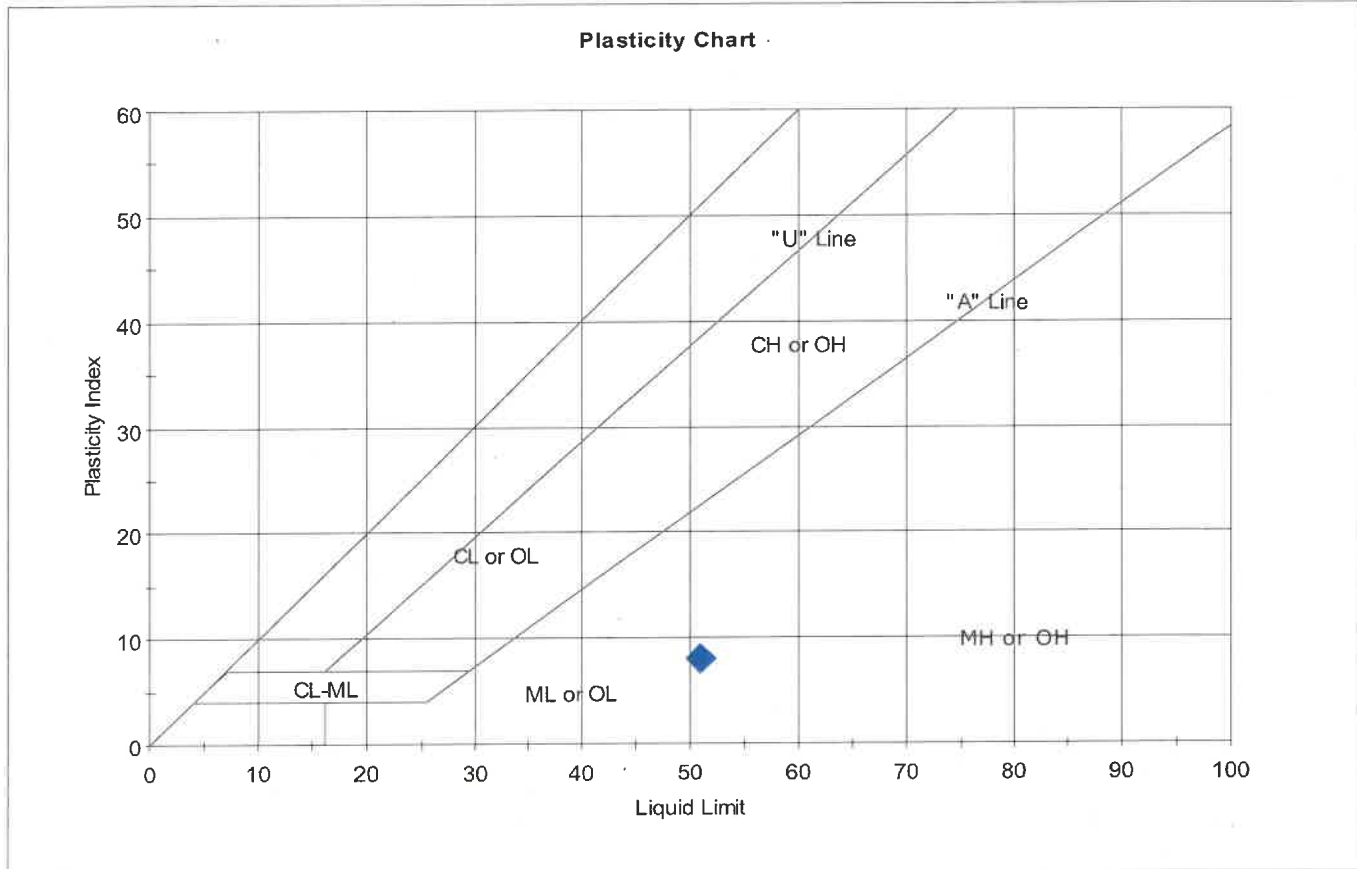

Symbol	Sample ID	Boring	Depth	Natural Moisture Content, %	Liquid Limit	Plastic Limit	Plasticity Index	Liquidity Index	Soil Classification
◆	S-7	B-05	25.7-27	54	51	43	8	1.4	

Sample Prepared using the WET method

Dry Strength: VERY HIGH

Dilatancy: SLOW

Toughness: LOW



Client:	Shannon & Wilson, Inc.		
Project:	PGE Memorial Substation		
Location:	Wilsonville, OR	Project No:	GTX-316148
Boring ID:	B-06	Sample Type:	tube
Sample ID:	S-7	Test Date:	09/28/22
Depth:	30-31.5	Test Id:	686841
Test Comment:	---		
Visual Description:	Moist, dark yellowish brown silt		
Sample Comment:	---		

## Atterberg Limits - ASTM D4318

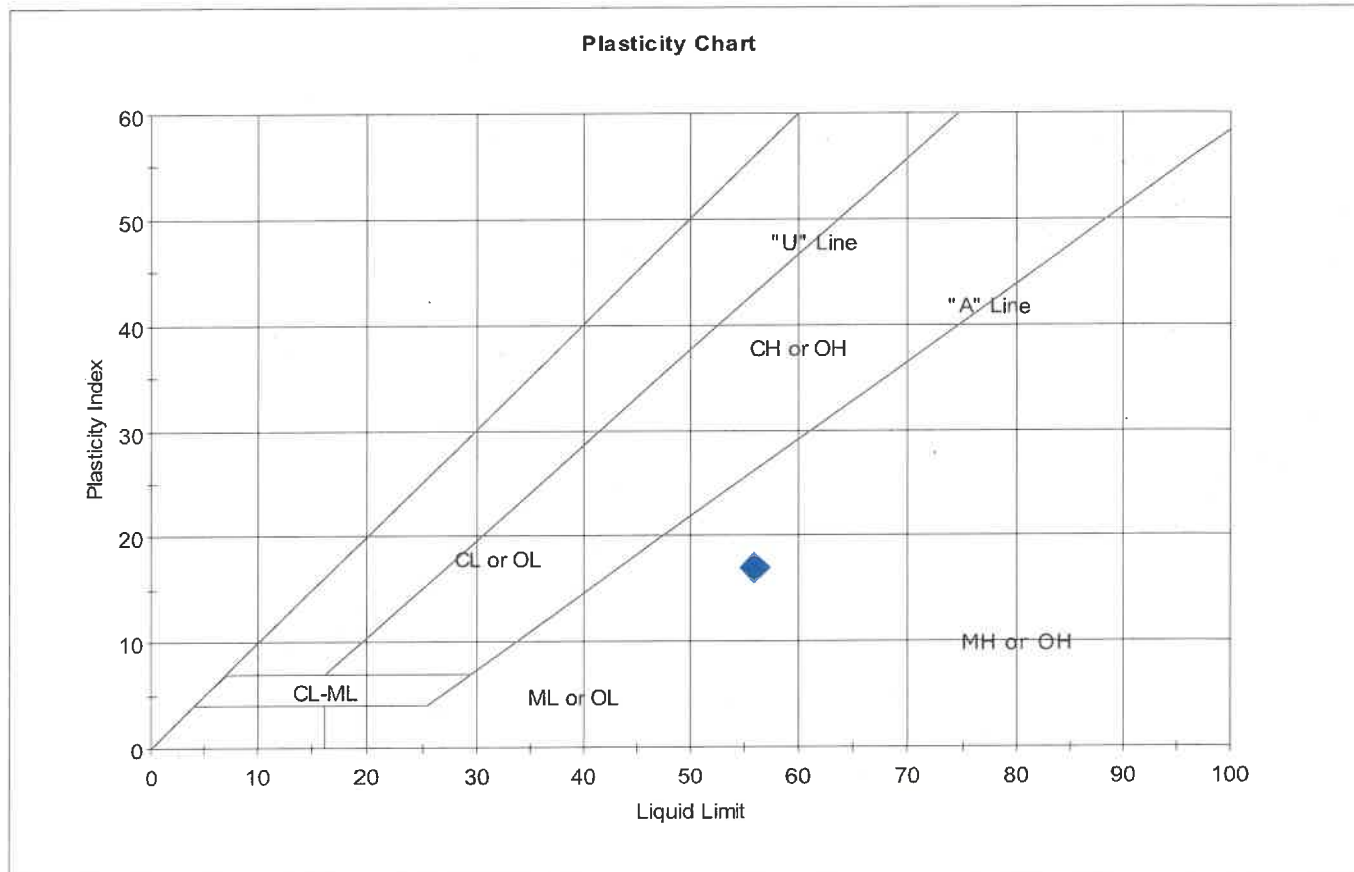

Symbol	Sample ID	Boring	Depth	Natural Moisture Content, %	Liquid Limit	Plastic Limit	Plasticity Index	Liquidity Index	Soil Classification
◆	S-7	B-06	30-31.5	53	56	39	17	0.8	

Sample Prepared using the WET method

Dry Strength: VERY HIGH

Dilatancy: SLOW

Toughness: LOW



21239 FM529 Rd., Bldg. F  
 Cypress, TX 77433  
 Tel: 281-985-9344  
 Fax: 832-427-1752  
[info@geothermusa.com](mailto:info@geothermusa.com)  
<http://www.geothermusa.com>

September 12, 2022

**Shannon & Wilson, Inc.**  
 3990 Collins Way, Suite 100  
 Lake Oswego, OR 97035  
**Attn: Cody K. Sorensen, CEG, LEG**

**Re: Thermal Analysis of Native Soil Samples  
 PGE Memorial Substation – Wilsonville, Oregon (Project No. 109680-001)**

The following is the report of thermal dryout characterization tests conducted on the six (6) tube samples of native soil from the referenced project sent to our laboratory.

**Thermal Resistivity Tests:** The tube samples were tested 'as received'. The tests were conducted in accordance with the IEEE standard 442-2017. The results are tabulated below and the thermal dryout curves are presented in **Figures 1 to 6**.

**Sample ID, Description, Thermal Resistivity, Moisture Content and Density**

Sample ID	Depth (ft)	Description (Shannon & Wilson)	Thermal Resistivity (°C-cm/W)		Moisture Content (%)	Dry Density (lb/ft <sup>3</sup> )
			Wet	Dry		
Boring B-1, S-2	5'	Brown, lean clay (CL)	76	241	30	90
Boring B-2, S-2	5'	Brown, lean clay w/ sand (CL)	70	207	24	100
Boring B-3, S-2	5'	Gray, lean clay w/ sand (CL)	78	236	31	88
Boring B-4, S-2	5'	Gray, lean clay w/ gravel (CL)	68	176	18	111
Boring B-5, S-2	5'	Brown, lean clay (CL)	77	260	30	91
Boring B-6, S-2	5'	Black, lean clay (CL)	70	181	18	109

Please contact us if you have any questions or if we can be of further assistance.

**Geotherm USA**

Nimesh Patel

COOL SOLUTIONS FOR UNDERGROUND POWER CABLES  
 THERMAL SURVEYS, CORRECTIVE BACKFILLS & INSTRUMENTATION

**Serving the electric power industry since 1978**





### THERMAL DRYOUT CURVE

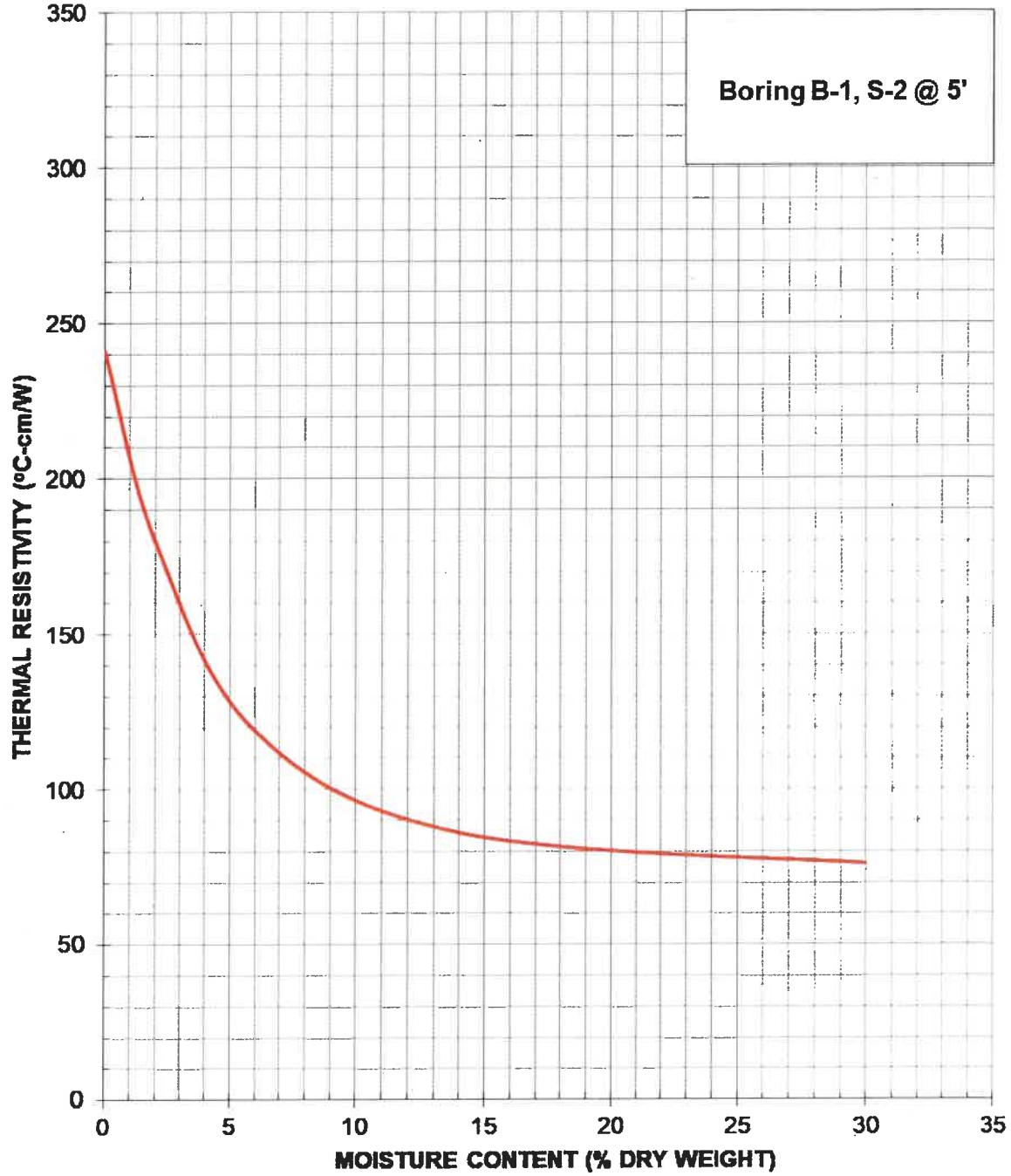

Shannon & Wilson, Inc. (Project No. 109680-001)

PGE Memorial Substation – Wilsonville, Oregon

Thermal Analysis of Native Soil Samples

September 2022

Figure 1



### THERMAL DRYOUT CURVE

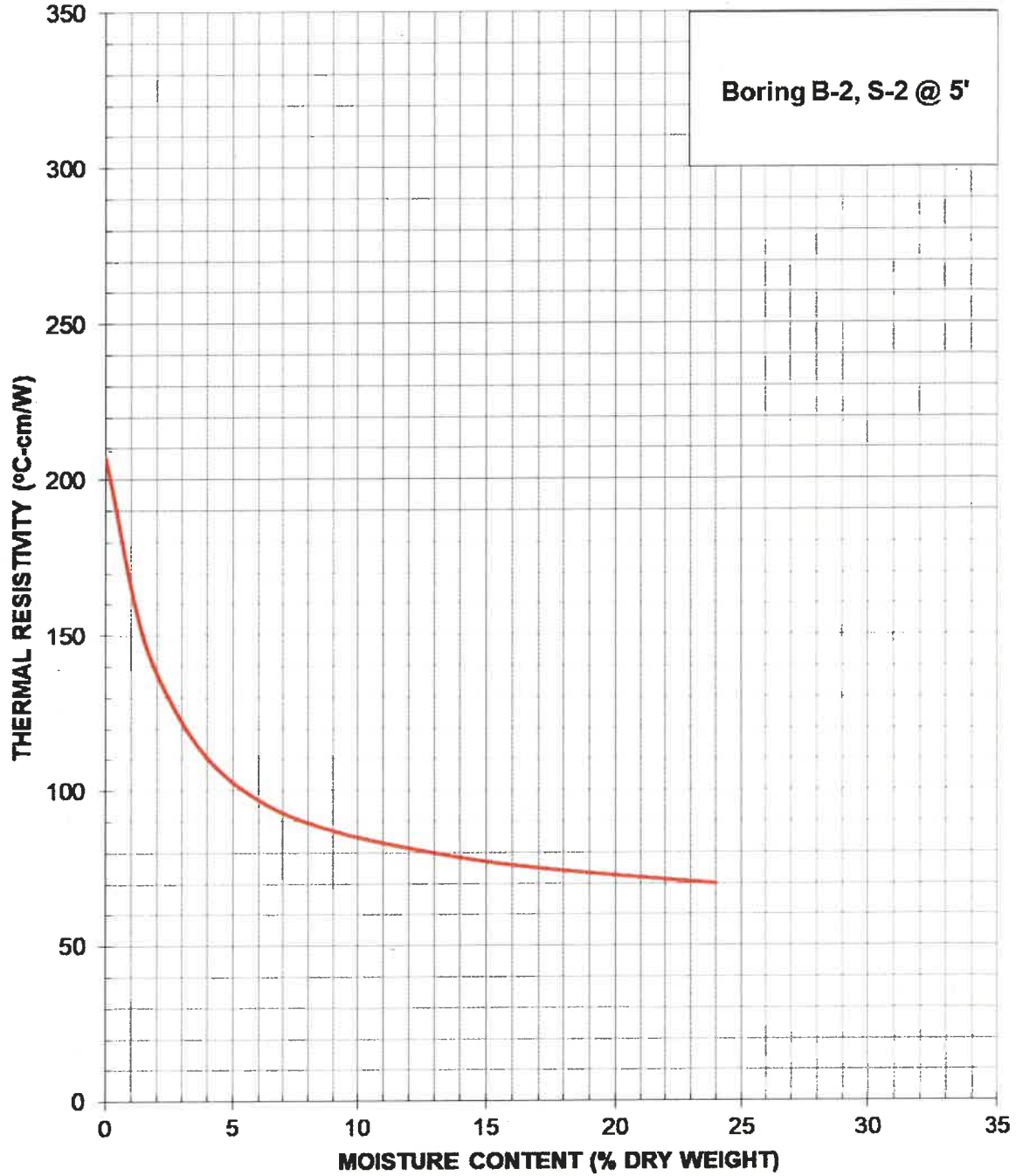

Shannon & Wilson, Inc. (Project No. 109680-001)

PGE Memorial Substation – Wilsonville, Oregon

Thermal Analysis of Native Soil Samples

September 2022

Figure 2



### THERMAL DRYOUT CURVE

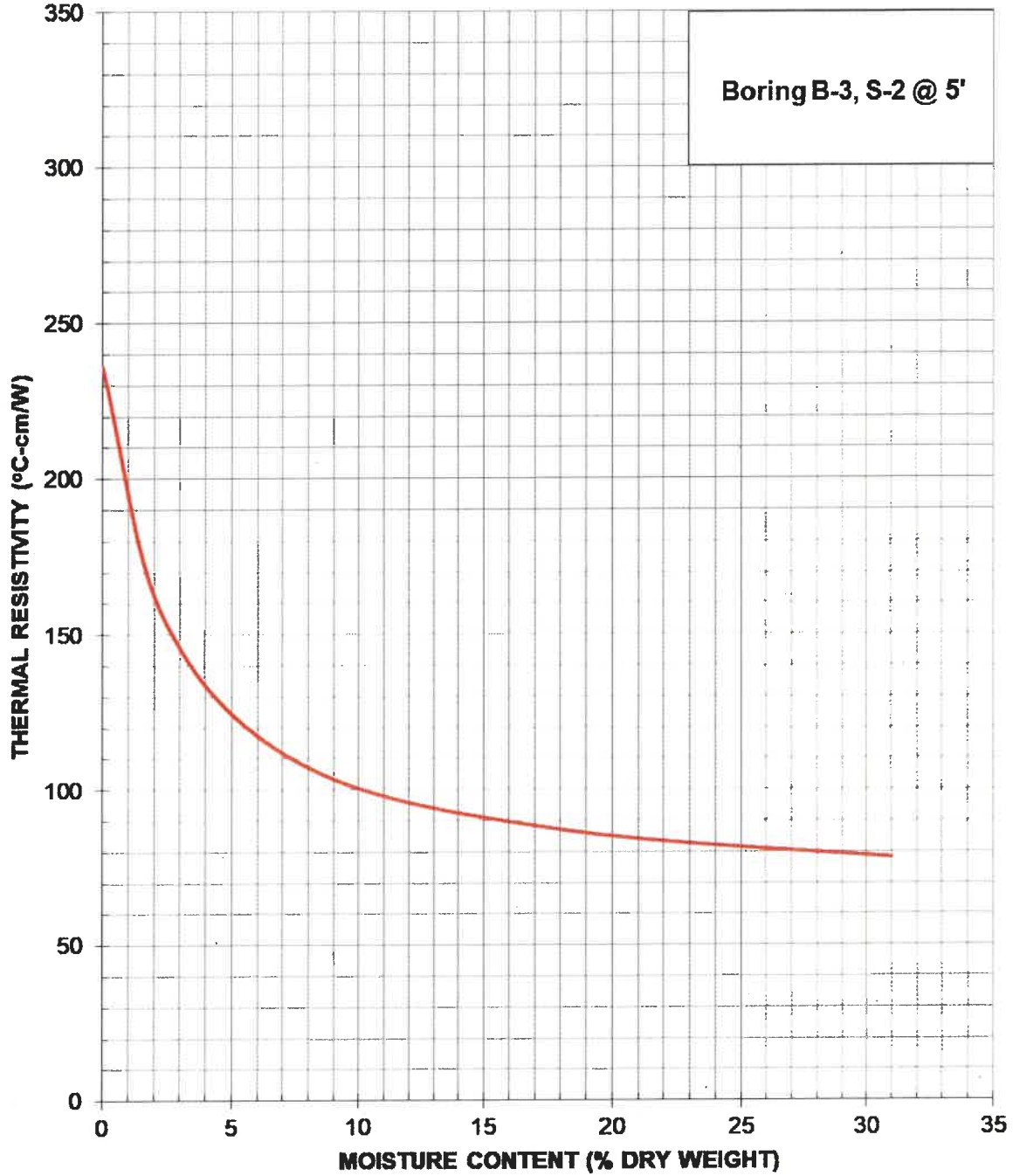

Shannon & Wilson, Inc. (Project No. 109680-001)

PGE Memorial Substation – Wilsonville, Oregon

Thermal Analysis of Native Soil Samples

September 2022

Figure 3



### THERMAL DRYOUT CURVE

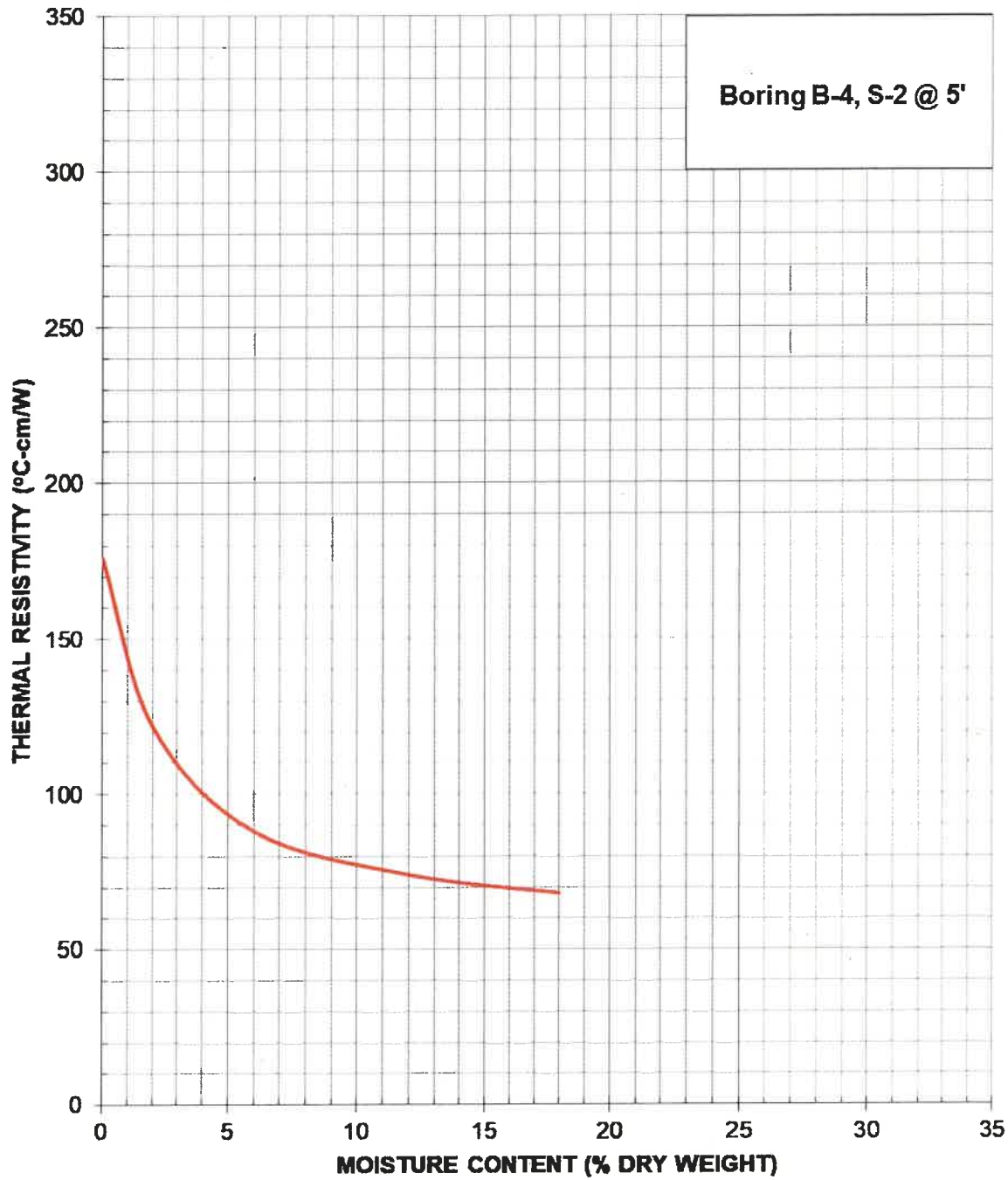

Shannon & Wilson, Inc. (Project No. 109680-001)

PGE Memorial Substation – Wilsonville, Oregon

Thermal Analysis of Native Soil Samples

September 2022

Figure 4



### THERMAL DRYOUT CURVE

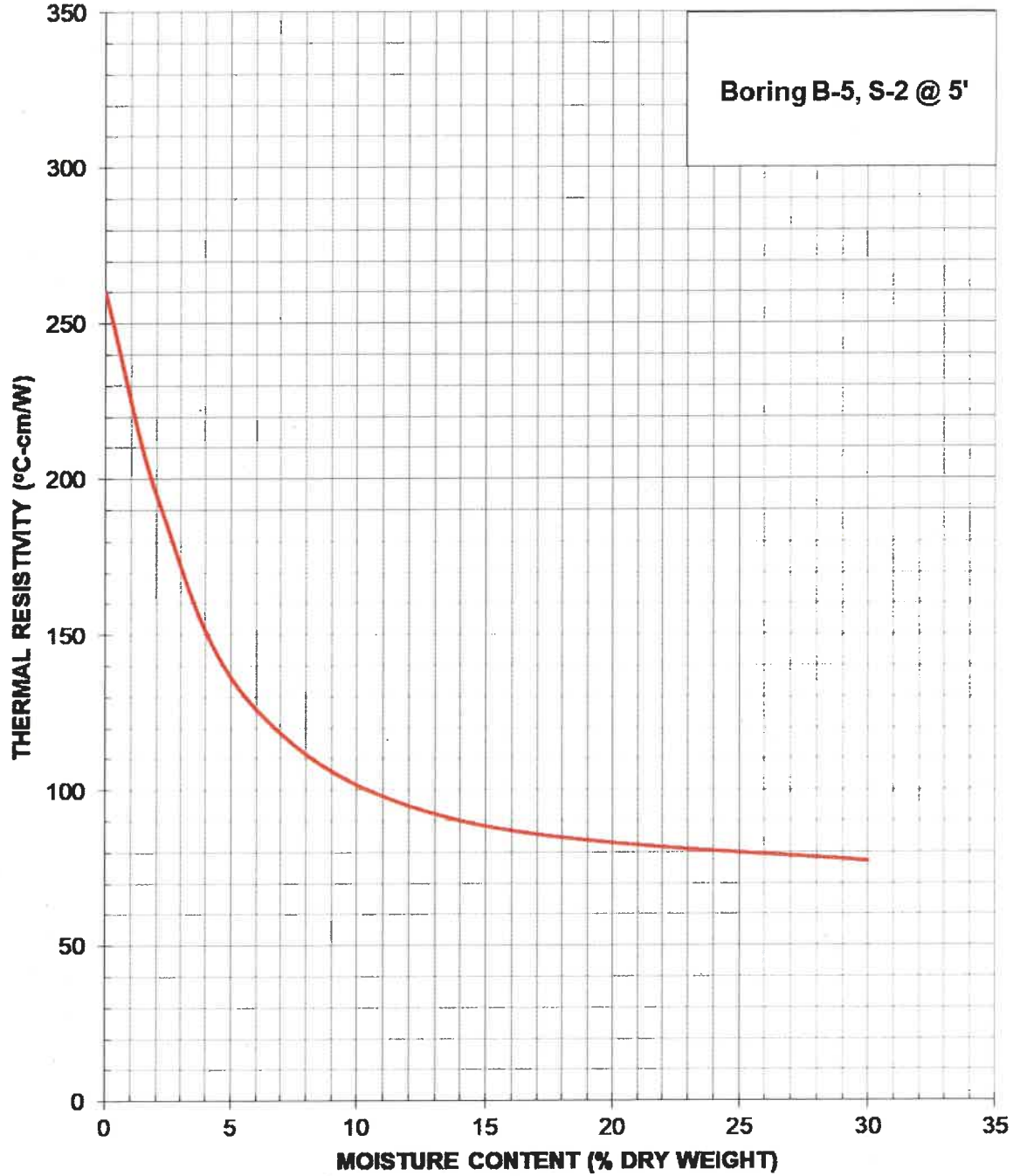

Shannon & Wilson, Inc. (Project No. 109680-001)

PGE Memorial Substation – Wilsonville, Oregon

Thermal Analysis of Native Soil Samples

September 2022

Figure 5



### THERMAL DRYOUT CURVE

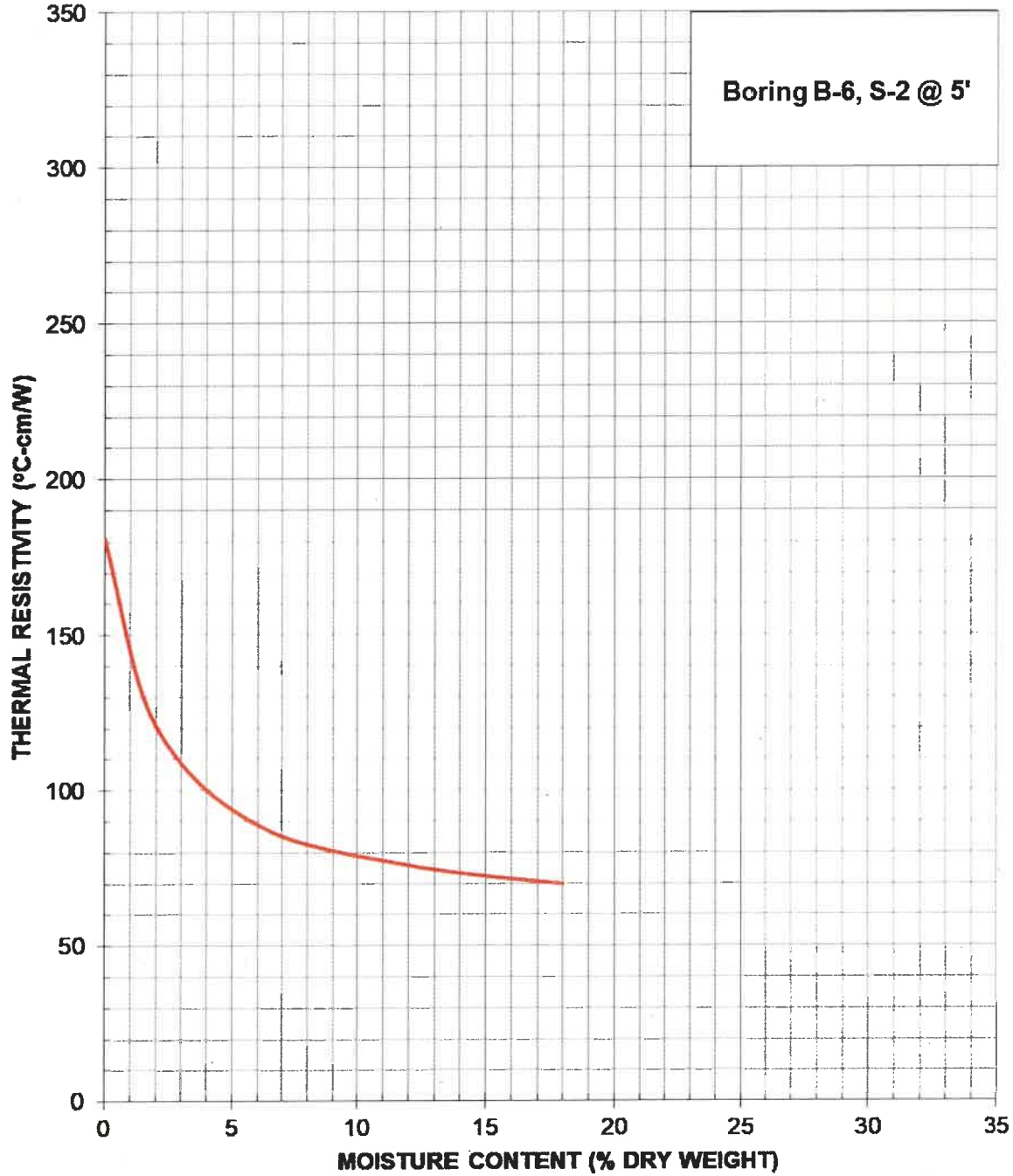

Shannon & Wilson, Inc. (Project No. 109680-001)

PGE Memorial Substation – Wilsonville, Oregon

Thermal Analysis of Native Soil Samples

September 2022

Figure 6

# Important Information

About Your Geotechnical/Environmental Report

IMPORTANT INFORMATION



## CONSULTING SERVICES ARE PERFORMED FOR SPECIFIC PURPOSES AND FOR SPECIFIC CLIENTS.

Consultants prepare reports to meet the specific needs of specific individuals. A report prepared for a civil engineer may not be adequate for a construction contractor or even another civil engineer. Unless indicated otherwise, your consultant prepared your report expressly for you and expressly for the purposes you indicated. No one other than you should apply this report for its intended purpose without first conferring with the consultant. No party should apply this report for any purpose other than that originally contemplated without first conferring with the consultant.

## THE CONSULTANT'S REPORT IS BASED ON PROJECT-SPECIFIC FACTORS.

A geotechnical/environmental report is based on a subsurface exploration plan designed to consider a unique set of project-specific factors. Depending on the project, these may include the general nature of the structure and property involved; its size and configuration; its historical use and practice; the location of the structure on the site and its orientation; other improvements such as access roads, parking lots, and underground utilities; and the additional risk created by scope-of-service limitations imposed by the client. To help avoid costly problems, ask the consultant to evaluate how any factors that change subsequent to the date of the report may affect the recommendations. Unless your consultant indicates otherwise, your report should not be used (1) when the nature of the proposed project is changed (for example, if an office building will be erected instead of a parking garage, or if a refrigerated warehouse will be built instead of an unrefrigerated one, or chemicals are discovered on or near the site); (2) when the size, elevation, or configuration of the proposed project is altered; (3) when the location or orientation of the proposed project is modified; (4) when there is a change of ownership; or (5) for application to an adjacent site. Consultants cannot accept responsibility for problems that may occur if they are not consulted after factors that were considered in the development of the report have changed.

## SUBSURFACE CONDITIONS CAN CHANGE.

Subsurface conditions may be affected as a result of natural processes or human activity. Because a geotechnical/environmental report is based on conditions that existed at the time of subsurface exploration, construction decisions should not be based on a report whose adequacy may have been affected by time. Ask the consultant to advise if additional tests are desirable before construction starts; for example, groundwater conditions commonly vary seasonally.

Construction operations at or adjacent to the site and natural events such as floods, earthquakes, or groundwater fluctuations may also affect subsurface conditions and, thus, the continuing adequacy of a geotechnical/environmental report. The consultant should be kept apprised of any such events and should be consulted to determine if additional tests are necessary.

## MOST RECOMMENDATIONS ARE PROFESSIONAL JUDGMENTS.

Site exploration and testing identifies actual surface and subsurface conditions only at those points where samples are taken. The data were extrapolated by your consultant, who then applied judgment to render an opinion about overall subsurface conditions. The actual interface between materials may be far more gradual or abrupt than your report indicates. Actual conditions in areas not sampled may differ from those predicted in your report. While nothing can be done to prevent such situations, you and your consultant can work together to help reduce their impacts. Retaining

your consultant to observe subsurface construction operations can be particularly beneficial in this respect.

#### A REPORT'S CONCLUSIONS ARE PRELIMINARY.

The conclusions contained in your consultant's report are preliminary, because they must be based on the assumption that conditions revealed through selective exploratory sampling are indicative of actual conditions throughout a site. Actual subsurface conditions can be discerned only during earthwork; therefore, you should retain your consultant to observe actual conditions and to provide conclusions. Only the consultant who prepared the report is fully familiar with the background information needed to determine whether or not the report's recommendations based on those conclusions are valid and whether or not the contractor is abiding by applicable recommendations. The consultant who developed your report cannot assume responsibility or liability for the adequacy of the report's recommendations if another party is retained to observe construction.

#### THE CONSULTANT'S REPORT IS SUBJECT TO MISINTERPRETATION.

Costly problems can occur when other design professionals develop their plans based on misinterpretation of a geotechnical/environmental report. To help avoid these problems, the consultant should be retained to work with other project design professionals to explain relevant geotechnical, geological, hydrogeological, and environmental findings, and to review the adequacy of their plans and specifications relative to these issues.

#### BORING LOGS AND/OR MONITORING WELL DATA SHOULD NOT BE SEPARATED FROM THE REPORT.

Final boring logs developed by the consultant are based upon interpretation of field logs (assembled by site personnel), field test results, and laboratory and/or office evaluation of field samples and data. Only final boring logs and data are customarily included in geotechnical/environmental reports. These final logs should not, under any circumstances, be redrawn for inclusion in architectural or other design drawings, because drafters may commit errors or omissions in the transfer process.

To reduce the likelihood of boring log or monitoring well misinterpretation, contractors should be given ready access to the complete geotechnical engineering/environmental report prepared or authorized for their use. If access is provided only to the report prepared for you, you should advise contractors of the report's limitations, assuming that a contractor was not one of the specific persons for whom the report was prepared, and that developing construction cost estimates was not one of the specific purposes for which it was prepared. While a contractor may gain important knowledge from a report prepared for another party, the contractor should discuss the report with your consultant and perform the additional or alternative work believed necessary to obtain the data specifically appropriate for construction cost estimating purposes. Some clients hold the mistaken impression that simply disclaiming responsibility for the accuracy of subsurface information always insulates them from attendant liability. Providing the best available information to contractors helps prevent costly construction problems and the adversarial attitudes that aggravate them to a disproportionate scale.

#### READ RESPONSIBILITY CLAUSES CLOSELY.

Because geotechnical/environmental engineering is based extensively on judgment and opinion, it is far less exact than other design disciplines. This situation has resulted in wholly unwarranted claims

being lodged against consultants. To help prevent this problem, consultants have developed a number of clauses for use in their contracts, reports, and other documents. These responsibility clauses are not exculpatory clauses designed to transfer the consultant's liabilities to other parties; rather, they are definitive clauses that identify where the consultant's responsibilities begin and end. Their use helps all parties involved recognize their individual responsibilities and take appropriate action. Some of these definitive clauses are likely to appear in your report, and you are encouraged to read them closely. Your consultant will be pleased to give full and frank answers to your questions.

**The preceding paragraphs are based on information provided by the ASFE/Association of Engineering Firms Practicing in the Geosciences, Silver Spring, Maryland**

IMPORTANT INFORMATION



March 22, 2023

Lindsay Phillips, PE  
POWER Engineers, Inc.  
3940 Glenbrook Drive,  
Hailey, ID 83333

RE: DRAFT ADDENDUM REPORT FOR ADDITIONAL EXPLORATIONS, PGE MEMORIAL SUBSTATION

Shannon & Wilson, Inc. has prepared this addendum to the previously submitted Geotechnical Engineering Report and participated in this project as a subconsultant to POWER Engineers, Inc. (POWER Engineers). Our services were performed in accordance with the General Services Agreement (Document "007-10327") for Geotechnical Services, dated October 23, 2020, and Task Order Number 003 dated February 27, 2023.

This letter report summarizes the results of additional explorations including test pits and infiltration testing performed by Shannon & Wilson, Inc. (Shannon & Wilson), to support design of the Portland General Electric (PGE) Memorial Substation Project, shown in the Vicinity Map, Figure 1. Shannon & Wilson provided a Geotechnical Investigation Report for the substation in November 2022. During our explorations in 2022, a layer of undocumented Fill was encountered at the surface in all the geotechnical borings performed. To better characterize the thickness of undocumented Fill throughout the site, PGE and KPFF requested additional explorations. The additional explorations include eight new test pit locations and two new locations for infiltration testing.

We understand the geotechnical goals for the additional phase of work are to:

- Perform field explorations and infiltration testing; and
- Provide an Addendum to the Geotechnical Investigation Report.

## SUBSURFACE EXPLORATIONS AND INFILTRATION TESTING

### Geotechnical Explorations

Shannon & Wilson performed eight test pits to better characterize the thickness of the undocumented Fill and performed four test pits with attempted infiltration testing to assist with the design of stormwater facilities. Approximate locations of the test pits are shown on the Site and Exploration Plan, Figure 2. A Shannon & Wilson staff geologist was on-site to

observe the test pit excavation, log the materials encountered and attempt the infiltration tests. The specific terminology used in the logging of the materials is defined on the Soil Description and Log Key, Figure 3. The test pits were completed on March 2, 2023, by a John Deere 50G mini-tracked excavator equipped with an 18-inch-wide toothed bucket, owned and operated by Western States Soil Conservation, Inc. of Hubbard, Oregon. The test pits designated TP-01 through TP-08, were excavated to approximate depths ranging from 6 to 10 feet. In addition, four test pits excavated to support infiltration testing, designated INF-02A/02B and INF-03A/03B, and were excavated to depths ranging from 4.5 to 6 feet. After completion of the test pits and infiltration testing, the test pits were backfilled with the excavated material and tamped with bottom of the excavator bucket in approximate 2-foot lifts. Logs of the test pits are presented in Figures 4 through 15.

## Summary of Subsurface Conditions

In general, the test pits encountered similar subsurface geologic conditions to the previous geotechnical borings. This would indicate subsurface conditions are generally uniform throughout the site. Each of the current test pit explorations encountered undocumented fill to depths ranging from 3 to 7.5 feet below the existing ground surface (bgs). The undocumented fill encountered in the test pits was similar to the undocumented fill encountered in the previous boring explorations in both depth and classification. Based on the test pit explorations, the undocumented fill generally consists of *Lean Clay (CL)* to *Gravelly Lean Clay (CL)* with trace amounts of asphalt fragments, wood debris, red brick fragments, and concrete fragments. Each of the current test pit explorations encountered Missoula Flood Deposits underlying the undocumented fill to the bottom of the explorations. The Missoula Flood Deposits generally consisted of *Lean Clay (CL)* to *Silt (ML)*.

Groundwater or perched water seepage was observed in test pits TP-01, TP-06, TP-07, TP-08, INF-02A/02B, and INF-03A/03B. Where encountered, groundwater or perched water seepage was noted on the test pit logs. Based on the test pit explorations, groundwater or perched water was encountered at depths generally ranging from 3 to 5.5 feet bgs. However, seepage was observed in test pit TP-06 at a depth of 1-foot bgs. A combination of heavy snow followed by snowmelt and heavy precipitation had occurred just prior to performing the current test pit explorations. Therefore, we anticipate this was contributing to the extent of surface water and shallow perched water observed in the test pit explorations. During our original subsurface explorations in August 2022, we observed groundwater on August 22<sup>nd</sup> in boring B-01 at a depth of 15.34 feet bgs, and on August 24<sup>th</sup> groundwater was observed in the drill casings left in boring B-01 at a depth of 20.4 feet.



Groundwater levels at the substation site will generally vary seasonally and with precipitation or local irrigation for landscaping. We assume groundwater highs would typically occur during or at the end of the wet season in late winter to late spring, and groundwater lows occur toward the end of the dry season at the end of summer and early fall.

## Infiltration Testing

Infiltration tests were attempted in accordance with the procedures described in Appendix B Infiltration Testing, of the *Stormwater & Surface Water Design and Construction Standards 2015, City of Wilsonville*. We initially excavated two test pits, INF-02A and INF-03A, to attempt open-pit falling head tests. The test pits were excavated to depths of 6 and 5.5 feet, respectively. Water seepage was observed in both test pits at a depth of 3 feet bgs, and eventually filled the bottom of the test pits with 10- to 12-inches of water which prevented the test from being performed. The initial two test pits were backfilled, and two additional test pits were excavated adjacent to the initial locations to attempt encased falling head tests, since the casing used for the test may seal off the assumed perched water we observed at 3 feet. The encased falling head test is performed within a 6-inch diameter casing which is driven 6-inches into the bottom of the test pit, and 12-inches of water is added for presoak and during subsequent tests. After adding 12-inches of water for the presoak to both casings, in one of the casings, the water dropped by 0.02 feet at location INF-03B after an hour and in the casing at location INF-02B, the water actually rose in the casing (i.e. the water in the casing was being influenced by the perched water). Based on these observations, no further attempts were made to perform the infiltration testing. The casings used during the encased falling head test attempts were left in place overnight to act as temporary open pipe monitoring wells. The water observed in the casings the next day was measured to be approximately 2.72 feet bgs in INF-02B, and 2.61 feet bgs in INF-03B.

## Slope Stability

During the site reconnaissance used to mark the current exploration locations, observations of the adjacent slope embankment surface were made. Based on our observations, we did not observe evidence of surficial instability within the slope embankment surface. Therefore, if the slope embankment remains in its current configuration or flatter, then we do not anticipate instability being an issue.

## LIMITATIONS

Shannon & Wilson has prepared this report in a professional manner, using a level of skill and care normally exercised for similar projects under similar conditions by reputable and competent geotechnical consultants currently practicing in the area, and in accordance with the terms and conditions set forth in our proposal. The facts and conditions referenced in this report may change over time, and the conclusions set forth herein are applicable to the facts and conditions as described only at the time of this report. Conclusions were made within the operative constraints of the scope, budget, and schedule for this project. We believe that the conditions stated here are factual, but no guarantee is made or implied. This report is for the exclusive use of POWER Engineers and PGE. We have prepared an enclosure, "Important Information About Your Geotechnical/Environmental Report," to help you and others understand the use and limitations of our reports.

Sincerely,

SHANNON & WILSON

Cody K. Sorensen, CEG  
Associate Engineering Geologist

Elliott C. Mecham, PE  
Senior Associate | Engineer

CKS:KJW:ECM/mmb

Enc. Figure 1: Vicinity Map  
Figure 2: Site and Exploration Plan  
Figure 3: Soil Description and Log Key  
Figures 4 through 11: Logs of Test Pits TP-01 through TP-08  
Figures 12 and 13: Logs of Test Pits INF-02A and INF-02B  
Figures 14 and 15: Logs of Test Pits INF-03A and INF-03B  
Important Information About Your Geotechnical/Environmental Report



Filename: P:\GIS\IPDX\109000s\109680\_PGE Memorial Sub\Arvxd\VicinityMap.mxd Date: 9/30/2022 Login: AEH



Sources: Esri, HERE, Garmin, Intermap, increment P Corp., GEBCO, USGS, FAO, NPS, NRCAN, GeoBase, IGN, Kadaster NL, Ordnance Survey, Esri Japan, METI, Esri China (Hong Kong), (c) OpenStreetMap contributors, and the GIS User Community

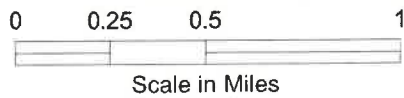

PGE Memorial Substation  
Wilsonville, Oregon

**VICINITY MAP**

March 2023

109680

**SHANNON & WILSON, INC.**  
GEOTECHNICAL AND ENVIRONMENTAL CONSULTANTS

**FIG. 1**



**LEGEND**

- TP-01 Designation and Approximate Location of Test Pit
- INF-02 Designation and Approximate Location of Pilot Infiltration Test
- B-01 Designation and Approximate Location of Boring
- INF-01 Designation and Approximate Location of Double-Ring Infiltration Test
- Approximate Location of Proposed Site Features

0 40 80 160

Scale in Feet

**NOTES**

1. Aerial imagery obtained through Google Maps Satellite.
2. Taxlots obtained through Metro RLIS.
3. Proposed features from file MMRL-1001-1.dwg, provided by POWER Engineers, Inc., on November 3, 2022.
4. Topographic contours prepared by S&F Land Services dated September 21, 2021 and provided by POWER Engineers, Inc. on March 21, 2023.
5. Fill depths shown in parentheses adjacent to exploration IDs.

PGE Memorial Substation  
Wilsonville, Oregon

**SITE AND EXPLORATION PLAN**

March 2023

109680

**SHANNON & WILSON, INC.**  
HYDROLOGICAL AND ENVIRONMENTAL CONSULTANTS

**FIG. 2**

**FIG. 2**



Shannon & Wilson, Inc. (S&W), uses a soil identification system modified from the Unified Soil Classification System (USCS). Elements of the USCS and other definitions are provided on this and the following pages. Soil descriptions are based on visual-manual procedures (ASTM D2488) and laboratory testing procedures (ASTM D2487), if performed.

### S&W INORGANIC SOIL CONSTITUENT DEFINITIONS

CONSTITUENT <sup>2</sup>	FINE-GRAINED SOILS (50% or more fines) <sup>1</sup>	COARSE-GRAINED SOILS (less than 50% fines) <sup>1</sup>
<b>Major</b>	<i>Silt, Lean Clay, Elastic Silt, or Fat Clay</i> <sup>3</sup>	<i>Sand or Gravel</i> <sup>4</sup>
<b>Modifying (Secondary)</b> Precedes major constituent	30% or more coarse-grained: <i>Sandy or Gravelly</i> <sup>4</sup>	More than 12% fine-grained: <i>Silty or Clayey</i> <sup>3</sup>
<b>Minor</b> Follows major constituent	15% to 30% coarse-grained: <i>with Sand or with Gravel</i> <sup>4</sup> 30% or more total coarse-grained and lesser coarse-grained constituent is 15% or more: <i>with Sand or with Gravel</i> <sup>5</sup>	5% to 12% fine-grained: <i>with Silt or with Clay</i> <sup>3</sup> 15% or more of a second coarse-grained constituent: <i>with Sand or with Gravel</i> <sup>5</sup>

<sup>1</sup>All percentages are by weight of total specimen passing a 3-inch sieve.

<sup>2</sup>The order of terms is: *Modifying Major with Minor*.

<sup>3</sup>Determined based on behavior.

<sup>4</sup>Determined based on which constituent comprises a larger percentage.

<sup>5</sup>Whichever is the lesser constituent.

### MOISTURE CONTENT TERMS

Dry	Absence of moisture, dusty, dry to the touch
Moist	Damp but no visible water
Wet	Visible free water, from below water table

### STANDARD PENETRATION TEST (SPT) SPECIFICATIONS

Hammer:	140 pounds with a 30-inch free fall. Rope on 6- to 10-inch-diam. cathead 2-1/4 rope turns, > 100 rpm
Sampler:	10 to 30 inches long Shoe I.D. = 1.375 inches Barrel I.D. = 1.5 inches Barrel O.D. = 2 inches
N-Value:	Sum blow counts for second and third 6-inch increments. Refusal: 50 blows for 6 inches or less; 10 blows for 0 inches.
<b>NOTE:</b> Penetration resistances (N-values) shown on boring logs are as recorded in the field and have not been corrected for hammer efficiency, overburden, or other factors.	











### PARTICLE SIZE DEFINITIONS

DESCRIPTION	SIEVE NUMBER AND/OR APPROXIMATE SIZE
FINES	< #200 (0.075 mm = 0.003 in.)
SAND Fine Medium Coarse	#200 to #40 (0.075 to 0.4 mm; 0.003 to 0.02 in.) #40 to #10 (0.4 to 2 mm; 0.02 to 0.08 in.) #10 to #4 (2 to 4.75 mm; 0.08 to 0.187 in.)
GRAVEL Fine Coarse	#4 to 3/4 in. (4.75 to 19 mm; 0.187 to 0.75 in.) 3/4 to 3 in. (19 to 76 mm)
COBBLES	3 to 12 in. (76 to 305 mm)
BOULDERS	> 12 in. (305 mm)

### RELATIVE DENSITY / CONSISTENCY

COHESIONLESS SOILS		COHESIVE SOILS	
N, SPT, BLOWS/FT.	RELATIVE DENSITY	N, SPT, BLOWS/FT.	RELATIVE CONSISTENCY
< 4	Very loose	< 2	Very soft
4 - 10	Loose	2 - 4	Soft
10 - 30	Medium dense	4 - 8	Medium stiff
30 - 50	Dense	8 - 15	Stiff
> 50	Very dense	15 - 30	Very stiff
		> 30	Hard

### WELL AND BACKFILL SYMBOLS

	Bentonite Cement Grout		Surface Cement Seal
	Bentonite Grout		Asphalt or Cap
	Bentonite Chips		Slough
	Silica Sand		Inclinator or Non-perforated Casing
	Gravel		Vibrating Wire Piezometer
	Perforated or Screened Casing		

### PERCENTAGES TERMS<sup>1,2</sup>

Trace	< 5%
Few	5 to 10%
Little	15 to 25%
Some	30 to 45%
Mostly	50 to 100%

<sup>1</sup>Gravel, sand, and fines estimated by mass. Other constituents, such as organics, cobbles, and boulders, estimated by volume.

<sup>2</sup>Reprinted, with permission, from ASTM D2488 - 09a Standard Practice for Description and Identification of Soils (Visual-Manual Procedure), copyright ASTM International, 100 Barr Harbor Drive, West Conshohocken, PA 19428. A copy of the complete standard may be obtained from ASTM International, www.astm.org.

PGE Memorial Substation  
Wilsonville, Oregon

### SOIL DESCRIPTION AND LOG KEY

March 2023

109680

SHANNON & WILSON, INC.  
Geotechnical and Environmental Consultants

FIG. 3  
Sheet 1 of 3

UNIFIED SOIL CLASSIFICATION SYSTEM (USCS) (Modified From USACE Tech Memo 3-357, ASTM D2487, and ASTM D2488)				
MAJOR DIVISIONS		GROUP/GRAPHIC SYMBOL	TYPICAL IDENTIFICATIONS	
COARSE-GRAINED SOILS (more than 50% retained on No. 200 sieve)	Gravels (more than 50% of coarse fraction retained on No. 4 sieve)	Gravel (less than 5% fines)	GW 	Well-Graded Gravel; Well-Graded Gravel with Sand
			GP 	Poorly Graded Gravel; Poorly Graded Gravel with Sand
		Silty or Clayey Gravel (more than 12% fines)	GM 	Silty Gravel; Silty Gravel with Sand
			GC 	Clayey Gravel; Clayey Gravel with Sand
	Sands (50% or more of coarse fraction passes the No. 4 sieve)	Sand (less than 5% fines)	SW 	Well-Graded Sand; Well-Graded Sand with Gravel
			SP 	Poorly Graded Sand; Poorly Graded Sand with Gravel
		Silty or Clayey Sand (more than 12% fines)	SM 	Silty Sand; Silty Sand with Gravel
			SC 	Clayey Sand; Clayey Sand with Gravel
FINE-GRAINED SOILS (50% or more passes the No. 200 sieve)	Silt and Clays (liquid limit less than 50)	Inorganic	ML 	Silt; Silt with Sand or Gravel; Sandy or Gravelly Silt
			CL 	Lean Clay; Lean Clay with Sand or Gravel; Sandy or Gravelly Lean Clay
		Organic	OL 	Organic Silt or Clay; Organic Silt or Clay with Sand or Gravel; Sandy or Gravelly Organic Silt or Clay
	Silt and Clays (liquid limit 50 or more)	Inorganic	MH 	Elastic Silt; Elastic Silt with Sand or Gravel; Sandy or Gravelly Elastic Silt
			CH 	Fat Clay; Fat Clay with Sand or Gravel; Sandy or Gravelly Fat Clay
		Organic	OH 	Organic Silt or Clay; Organic Silt or Clay with Sand or Gravel; Sandy or Gravelly Organic Silt or Clay
HIGHLY-ORGANIC SOILS	Primarily organic matter, dark in color, and organic odor	PT 	Peat or other highly organic soils (see ASTM D4427)	
FILL	Placed by humans, both engineered and nonengineered. May include various soil materials and debris.		The Fill graphic symbol is combined with the soil graphic that best represents the observed material	

NOTE: No. 4 size = 4.75 mm = 0.187 in.; No. 200 size = 0.075 mm = 0.003 in.

NOTES

- Dual symbols (symbols separated by a hyphen, i.e., SP-SM, Sand with Silt) are used for soils with between 5% and 12% fines or when the liquid limit and plasticity index values plot in the CL-ML area of the plasticity chart.
- Borderline symbols (symbols separated by a slash, i.e., CL/ML, Lean Clay to Silt; SP-SM/SM, Sand with Silt to Silty Sand) indicate that the soil properties are close to the defining boundary between two groups.
- The soil graphics above represent the various USCS identifications (i.e., GP, SM, etc.) and may be augmented with additional symbology to represent differences within USCS designations. Sandy Silt (ML), for example, may be accompanied by the ML soil graphic with sand grains added. Non-USCS materials may be represented by other graphic symbols; see log for descriptions.

PGE Memorial Substation Wilsonville, Oregon	
<b>SOIL DESCRIPTION AND LOG KEY</b>	
March 2023	109680
<b>SHANNON &amp; WILSON, INC.</b> Geotechnical and Environmental Consultants	<b>FIG. 3</b> Sheet 2 of 3

2013\_BORING\_CLASS2\_109680.GPJ SW2013\LIBRARY\PD\X.GLB SWNEW.GDT 3/20/23

**GRADATION TERMS**

Poorly Graded	Narrow range of grain sizes present or, within the range of grain sizes present, one or more sizes are missing (Gap Graded). Meets criteria in ASTM D2487, if tested.
Well-Graded	Full range and even distribution of grain sizes present. Meets criteria in ASTM D2487, if tested.

**CEMENTATION TERMS<sup>1</sup>**

Weak	Crumbles or breaks with handling or slight finger pressure
Moderate	Crumbles or breaks with considerable finger pressure
Strong	Will not crumble or break with finger pressure

**PLASTICITY<sup>2</sup>**

DESCRIPTION	VISUAL-MANUAL CRITERIA	APPROX. PLASTICITY INDEX RANGE
Nonplastic	A 1/8-in. thread cannot be rolled at any water content.	< 4%
Low	A thread can barely be rolled and a lump cannot be formed when drier than the plastic limit.	4 to 10%
Medium	A thread is easy to roll and not much time is required to reach the plastic limit. The thread cannot be rerolled after reaching the plastic limit. A lump crumbles when drier than the plastic limit.	10 to 20%
High	It take considerable time rolling and kneading to reach the plastic limit. A thread can be rerolled several times after reaching the plastic limit. A lump can be formed without crumbling when drier than the plastic limit.	> 20%

**ADDITIONAL TERMS**

Mottled	Irregular patches of different colors.
Bioturbated	Soil disturbance or mixing by plants or animals.
Diamict	Nonsorted sediment; sand and gravel in silt and/or clay matrix.
Cuttings	Material brought to surface by drilling.
Slough	Material that caved from sides of borehole.
Sheared	Disturbed texture, mix of strengths.

**PARTICLE ANGULARITY AND SHAPE TERMS<sup>1</sup>**

Angular	Sharp edges and unpolished planar surfaces.
Subangular	Similar to angular, but with rounded edges.
Subrounded	Nearly planar sides with well-rounded edges.
Rounded	Smoothly curved sides with no edges.
Flat	Width/thickness ratio > 3.
Elongated	Length/width ratio > 3.

<sup>1</sup>Reprinted, with permission, from ASTM D2488 - 09a Standard Practice for Description and Identification of Soils (Visual-Manual Procedure), copyright ASTM International, 100 Barr Harbor Drive, West Conshohocken, PA 19428. A copy of the complete standard may be obtained from ASTM International, www.astm.org.

<sup>2</sup>Adapted, with permission, from ASTM D2488 - 09a Standard Practice for Description and Identification of Soils (Visual-Manual Procedure), copyright ASTM International, 100 Barr Harbor Drive, West Conshohocken, PA 19428. A copy of the complete standard may be obtained from ASTM International, www.astm.org.

**ACRONYMS AND ABBREVIATIONS**

ATD	At Time of Drilling
approx.	Approximate/Approximately
Diam.	Diameter
Elev.	Elevation
ft.	Feet
FeO	Iron Oxide
gal.	Gallons
Horiz.	Horizontal
HSA	Hollow Stem Auger
I.D.	Inside Diameter
in.	Inches
lbs.	Pounds
MgO	Magnesium Oxide
mm	Millimeter
MnO	Manganese Oxide
NA	Not Applicable or Not Available
NP	Nonplastic
O.D.	Outside Diameter
OW	Observation Well
pcf	Pounds per Cubic Foot
PID	Photo-Ionization Detector
PMT	Pressuremeter Test
ppm	Parts per Million
psi	Pounds per Square Inch
PVC	Polyvinyl Chloride
rpm	Rotations per Minute
SPT	Standard Penetration Test
USCS	Unified Soil Classification System
q <sub>u</sub>	Unconfined Compressive Strength
VWP	Vibrating Wire Piezometer
Vert.	Vertical
WOH	Weight of Hammer
WOR	Weight of Rods
Wt.	Weight

**STRUCTURE TERMS<sup>1</sup>**

Interbedded	Alternating layers of varying material or color with layers at least 1/4-inch thick; singular: bed.
Laminated	Alternating layers of varying material or color with layers less than 1/4-inch thick; singular: lamination.
Fissured	Breaks along definite planes or fractures with little resistance.
Slickensided	Fracture planes appear polished or glossy; sometimes striated.
Blocky	Cohesive soil that can be broken down into small angular lumps that resist further breakdown.
Lensed	Inclusion of small pockets of different soils, such as small lenses of sand scattered through a mass of clay.
Homogeneous	Same color and appearance throughout.

PGE Memorial Substation  
Wilsonville, Oregon

**SOIL DESCRIPTION  
AND LOG KEY**









March 2023

109680

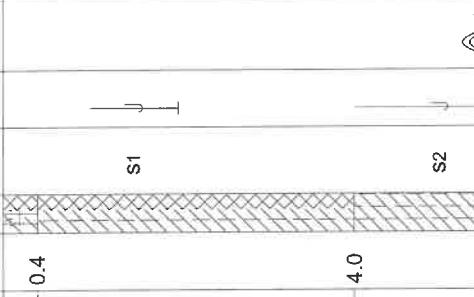

**SHANNON & WILSON, INC.**  
Geotechnical and Environmental Consultants

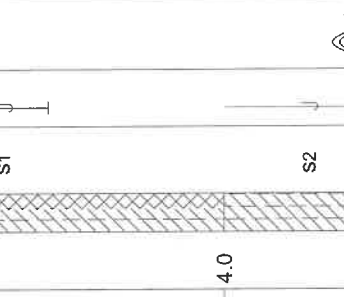
**FIG. 3**  
Sheet 3 of 3



SOIL PROFILE DESCRIPTION	Depth (ft)	Symbol	Samples	Type	Ground Water	NOTES	TEST PIT PHOTOS
Coordinates: N: 610,719 E: 7,618,988 Elevation: 221 Topsoil Brown, Lean Clay with Gravel (CL); moist; trace angular cobbles; fine to coarse, angular to subrounded gravel; trace fine to coarse sand; medium plasticity; trace asphalt fragments; disturbed texture.	0.4		S1			Test pit excavated using a John Deere 50G with a 18-inch wide toothed bucket	
FILL	4.0		S2			Seepage at 5.5 feet	
MISSOULA FLOOD DEPOSITS	6.0		S3				
Completed: March 2, 2023	7.5						

**LEGEND**

 Seepage  
 Jar Sample

**NOTES**

- The description in the text of this report is necessary for a proper understanding of the nature of the subsurface materials.
- Refer to Soil Classification and Log Key for explanation of "Symbols" and Definitions.
- Group symbol is based on visual-manual identification.
- Where possible, a 1/2-inch-diameter, steel T-bar probe was used to estimate the density of soil.

PGE Memorial Substation  
 Wilsonville, Oregon

**LOG OF TEST PIT TP-01**







March 2023 109680

**SHANNON & WILSON, INC.**  
 Geotechnical and Environmental Consultants

**FIG. 4**

REV 2



SOIL PROFILE DESCRIPTION	Depth (ft)	Symbol	Samples	Type	Ground Water	NOTES	TEST PIT PHOTOS
<p>Coordinates: N: 610,715 E: 7,618,803 Elevation: 224</p> <p><u>Topsoil</u></p> <p>Dark brown, <i>Lean Clay with Gravel (CL)</i>; moist; trace angular cobbles; fine to coarse; angular to subrounded gravel; trace fine to coarse sand; medium plasticity; trace asphalt clasts; disturbed texture.</p> <p style="text-align: center;"><b>FILL</b></p> <p>Gray brown mottled, <i>Lean Clay (CL)</i>; moist; trace fine sand; low plasticity; slight iron oxide staining; trace rootlets; micaceous.</p> <p style="text-align: center;"><b>MISSOULA FLOOD DEPOSITS</b></p> <p>Completed: March 2, 2023</p>	0.4   3.8  8.0	    	S1  S2	  		Test pit excavated using a John Deere 50G with a 18-inch wide toothed bucket	

**LEGEND**

 Seepage

 Jar Sample

**NOTES**

- The description in the text of this report is necessary for a proper understanding of the nature of the subsurface materials.
- Refer to Soil Classification and Log Key for explanation of "Symbols" and Definitions.
- Group symbol is based on visual-manual identification.
- Where possible, a 1/2-inch-diameter, steel T-bar probe was used to estimate the density of soil.

**FIG. 5**

PGE Memorial Substation  
Wilsonville, Oregon

**LOG OF TEST PIT TP-02**

March 2023 109680

**SHANNON & WILSON, INC.**  
Geotechnical and Environmental Consultants

**FIG. 5**

REV 2

SOIL PROFILE DESCRIPTION	Depth (ft)	Symbol	Samples	Type	Ground Water	NOTES	TEST PIT PHOTOS
<p>Coordinates: N: 610,725 E: 7,618,694 Elevation: 225</p> <p><b>Topsoil</b></p> <p>Dark brown, Lean Clay (CL); moist; trace fine to coarse, subangular to subrounded gravel; trace fine to coarse sand; low plasticity; trace asphalt fragments; disturbed texture.</p>	0.4		S1			Test pit excavated using a John Deere 50G with a 18-inch wide toothed bucket	
<p><b>FILL</b></p>	4.0		S2				
<p>Gray brown mottled, Silt (ML); moist; trace fine to medium sand; low plasticity; slight iron oxide staining; micaceous.</p> <p><b>MISSOULA FLOOD DEPOSITS</b></p>	8.5						
Completed: March 2, 2023							

**LEGEND**

- Seepage
- Jar Sample

**NOTES**

- The description in the text of this report is necessary for a proper understanding of the nature of the subsurface materials.
- Refer to Soil Classification and Log Key for explanation of "Symbols" and Definitions.
- Group symbol is based on visual-manual identification.
- Where possible, a 1/2-inch-diameter, steel T-bar probe was used to estimate the density of soil.

PGE Memorial Substation  
Wilsonville, Oregon

**LOG OF TEST PIT TP-03**









March 2023 109680

**SHANNON & WILSON, INC.**  
Geotechnical and Environmental Consultants

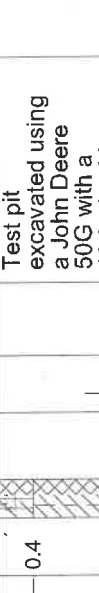
**FIG. 6**

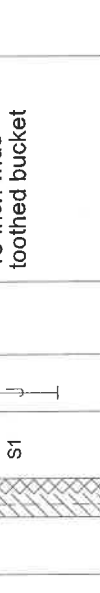
REV 2

**FIG. 6**

SOIL PROFILE DESCRIPTION	Depth (ft)	Symbol	Samples	Type	Ground Water	NOTES	TEST PIT PHOTOS
Coordinates: N: 610,943 E: 7,618,698 Elevation: 224 Topsoil	0.4		S1			Test pit excavated using a John Deere 50G with a 18-inch wide toothed bucket	
Dark brown, Lean Clay with Gravel (CL); moist; fine to coarse, angular to subrounded gravel; trace fine to coarse sand; low plasticity; trace wood debris and rootlets; trace asphalt and red brick fragments; disturbed texture.  FILL	7.5		S2				
Dark gray, Lean Clay (CL); moist; trace fine to coarse, subrounded to rounded gravel; low to medium plasticity; trace rootlets.  MISSOULA FLOOD DEPOSITS	10.0		S3				
Completed: March 2, 2023							

**LEGEND**

 Seepage  
 Jar Sample

**NOTES**

- The description in the text of this report is necessary for a proper understanding of the nature of the subsurface materials.
- Refer to Soil Classification and Log Key for explanation of "Symbols" and Definitions.
- Group symbol is based on visual-manual identification.
- Where possible, a 1/2-inch-diameter, steel T-bar probe was used to estimate the density of soil.

**FIG. 7**

PGE Memorial Substation  
Wilsonville, Oregon

**LOG OF TEST PIT TP-04**

March 2023 109680

**SHANNON & WILSON, INC.**  
Geotechnical and Environmental Consultants

**FIG. 7**

REV 2



SOIL PROFILE DESCRIPTION	Depth (ft)	Symbol	Samples	Type	Ground Water	NOTES	TEST PIT PHOTOS
<p><b>SOIL PROFILE DESCRIPTION</b>                      Coordinates: N: 611,132 E: 7,618,695                      Elevation: 219</p> <p><b>Topsoil</b>                      Dark brown, Lean Clay with Gravel (CL); moist; trace angular cobbles; fine to coarse; angular to subrounded gravel; trace fine to coarse sand; low plasticity; trace asphalt fragments; disturbed texture.</p> <p style="text-align: center;"><b>FILL</b></p>	0.4		S1			Test pit excavated using a John Deere 50G with a 18-inch wide toothed bucket	
<p>Dark gray, Lean Clay (CL); moist; trace fine subrounded gravel; trace fine to medium sand; low plasticity; micaceous.</p> <p style="text-align: center;"><b>MISSOULA FLOOD DEPOSITS</b></p> <p>Completed: March 2, 2023</p>	5.0 7.0		S2				

**LEGEND**

Seepage

Jar Sample

**NOTES**

- The description in the text of this report is necessary for a proper understanding of the nature of the subsurface materials.
- Refer to Soil Classification and Log Key for explanation of "Symbols" and Definitions.
- Group symbol is based on visual-manual identification.
- Where possible, a 1/2-inch-diameter, steel T-bar probe was used to estimate the density of soil.

**FIG. 8**

PGE Memorial Substation  
Wilsonville, Oregon







**LOG OF TEST PIT TP-05**

March 2023 109680

SHANNON & WILSON, INC.  
Geotechnical and Environmental Consultants

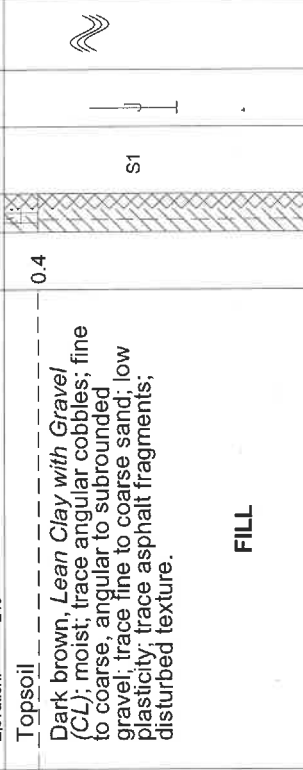
FIG. 8

REV 2

SOIL PROFILE DESCRIPTION Coordinates: N: 611,144 E: 7,618,797 Elevation: 219	Depth (ft)	Symbol	Samples	Type	Ground Water	NOTES	TEST PIT PHOTOS
<p><b>Topsoil</b></p> <p>Dark brown, Lean Clay with Gravel (CL); moist; trace angular cobbles; fine to coarse, angular to subrounded gravel; trace fine to coarse sand; low plasticity; trace asphalt fragments; disturbed texture.</p>	0.4		S1			<p>Test pit excavated using a John Deere 50G with a 18-inch wide toothed bucket Seepage at 1.0 feet</p>	
<p><b>FILL</b></p> <p>Gray brown mottled, Lean Clay (CL); moist; trace fine to medium sand; medium plasticity; slight iron oxide staining; micaceous.</p>	3.5		S2				
<p><b>MISSOULA FLOOD DEPOSITS</b></p> <p>Completed: March 2, 2023</p>	6.0						

**LEGEND**

 Seepage

 Jar Sample

**NOTES**

- The description in the text of this report is necessary for a proper understanding of the nature of the subsurface materials.
- Refer to Soil Classification and Log Key for explanation of "Symbols" and Definitions.
- Group symbol is based on visual-manual identification.
- Where possible, a 1/2-inch-diameter, steel T-bar probe was used to estimate the density of soil.

**FIG. 9**

PGE Memorial Substation  
Wilsonville, Oregon

**LOG OF TEST PIT TP-06**

March 2023

109680

**SHANNON & WILSON, INC.**  
Geotechnical and Environmental Consultants

**FIG. 9**

SOIL PROFILE DESCRIPTION	Depth (ft)	Symbol	Samples	Type	Ground Water	NOTES	TEST PIT PHOTOS
Coordinates: N: 611,139 E: 7,618,911 Elevation: 222 Topsoil Dark brown, Lean Clay with Gravel (CL); moist; fine to coarse, angular to subangular gravel; trace fine to coarse sand; low plasticity; trace asphalt fragments; trace pieces of Geotextile fabric; disturbed texture. FILL	0.4		S1			Test pit excavated using a John Deere 50G with a 18-inch wide toothed bucket	
Gray brown mottled, Lean Clay (CL); moist; trace fine to medium sand; low plasticity; slight iron oxide staining; micaceous. MISSOULA FLOOD DEPOSITS	3.0		S2			Seepage at 3.0 feet	
Completed: March 2, 2023	6.0						

**LEGEND**

Seepage

Jar Sample

**NOTES**

- The description in the text of this report is necessary for a proper understanding of the nature of the subsurface materials.
- Refer to Soil Classification and Log Key for explanation of "Symbols" and Definitions.
- Group symbol is based on visual-manual identification.
- Where possible, a 1/2-inch-diameter, steel T-bar probe was used to estimate the density of soil.

**FIG. 10**

PGE Memorial Substation  
Wilsonville, Oregon

**LOG OF TEST PIT TP-07**

March 2023

109680

**SHANNON & WILSON, INC.**  
Geotechnical and Environmental Consultants

**FIG. 10**

REV 2



SOIL PROFILE DESCRIPTION	Depth (ft)	Symbol	Samples	Type	Ground Water	NOTES	TEST PIT PHOTOS
<p>Coordinates: N: 610,912 E: 7,618,957 Elevation: 223</p> <p>Topsoil</p> <p>Dark brown, <i>Lean Clay with Gravel (CL)</i>; moist; trace angular cobbles; fine to coarse, angular to subangular gravel; trace fine to coarse sand; medium plasticity; trace asphalt and concrete fragments; disturbed texture.</p> <p style="text-align: center;"><b>FILL</b></p>	0.4		S1			Test pit excavated using a John Deere 50G with a 18" wide toothed bucket with claw	
<p>Gray brown mottled, <i>Lean Clay (CL)</i>; moist; low plasticity; slight iron oxide staining; trace rootlets; micaceous.</p> <p style="text-align: center;"><b>MISSOULA FLOOD DEPOSITS</b></p>	3.0		S2			Seepage at 5.0 feet	
Completed: March 2, 2023							

**LEGEND**

Seepage

Jar Sample

**NOTES**

- The description in the text of this report is necessary for a proper understanding of the nature of the subsurface materials. Refer to Soil Classification and Log Key for explanation of "Symbols" and Definitions.
- Group symbol is based on visual-manual identification.
- Where possible, a 1/2-inch-diameter, steel T-bar probe was used to estimate the density of soil.

**FIG. 11**



PGE Memorial Substation  
Wilsonville, Oregon

**LOG OF TEST PIT TP-08**

March 2023 109680

**SHANNON & WILSON, INC.**  
Geotechnical and Environmental Consultants

**FIG. 11**

SOIL PROFILE DESCRIPTION	Depth (ft)	Symbol	Samples	Type	Ground Water	NOTES	TEST PIT PHOTOS
<p>Coordinates: N: 611,163 E: 7,618,729 Elevation: 218</p> <p>Topsoil</p> <p>Dark brown, Lean Clay (CL); moist; trace fine to coarse, angular to subrounded gravel; trace fine to coarse sand; low plasticity; trace asphalt fragments; disturbed texture.</p> <p style="text-align: center;"><b>FILL</b></p> <p>Dark brown, Gravelly Lean Clay (CL); moist; fine to coarse, angular to subrounded gravel; trace fine to coarse sand; low plasticity; trace asphalt fragments; disturbed texture; plastic rubbish and debris at 3 feet.</p> <p>Dark gray, Lean Clay (CL); moist; low plasticity; trace rootlets.</p> <p style="text-align: center;"><b>MISSOULA FLOOD DEPOSITS</b></p> <p>Completed: March 2, 2023</p>	<p>0.4</p> <p>1.5</p> <p>3.0</p> <p>6.0</p>					<p>Test pit excavated using a John Deere 50G with a 18-inch wide toothed bucket</p> <p>Seepage at 3.0 feet</p> <p>Seepage filled bottom of test pit with approximately 10-inches of water. Unable to perform infiltration testing using open pit method.</p> <p>Excavated adjacent test pit (INT-02B) to attempt encased falling head infiltration test.</p>	

**LEGEND**

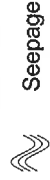

**NOTES**

1. The description in the text of this report is necessary for a proper understanding of the nature of the subsurface materials.
2. Refer to Soil Classification and Log Key for explanation of "Symbols" and Definitions.
3. Group symbol is based on visual-manual identification.
4. Where possible, a 1/2-inch-diameter, steel T-bar probe was used to estimate the density of soil.

**FIG. 12**

PGE Memorial Substation  
Wilsonville, Oregon

**LOG OF TEST PIT INF-02A**

March 2023

109680



**SHANNON & WILSON, INC.**  
Geotechnical and Environmental Consultants

**FIG. 12**

REV 2

SOIL PROFILE DESCRIPTION	Depth (ft)	Symbol	Samples	Type	Ground Water	NOTES	TEST PIT PHOTOS
Topsoil	0.4	[Hatched Pattern]					
Dark brown, Lean Clay (CL); moist; trace fine to coarse, angular to subrounded gravel; trace fine to coarse sand; low plasticity; trace asphalt fragments; disturbed texture.	1.5	[Hatched Pattern]					
Dark brown, Gravelly Lean Clay (CL); moist; fine to coarse, angular to subrounded gravel; trace fine to coarse sand; low plasticity; trace asphalt fragments; disturbed texture; plastic rubbish and debris at 3 feet.	3.0	[Hatched Pattern]					
Dark gray, Lean Clay (CL); moist; low plasticity; trace rootlets.	4.5	[Hatched Pattern]	HA-1	G			
<p><b>MISSOULA FLOOD DEPOSITS</b> Completed: March 2, 2023</p>							

**LEGEND**



 Seepage  
 Grab Sample

**NOTES**

- The description in the text of this report is necessary for a proper understanding of the nature of the subsurface materials.
- Refer to Soil Classification and Log Key for explanation of "Symbols" and Definitions.
- Group symbol is based on visual-manual identification.
- Where possible, a 1/2-inch-diameter, steel T-bar probe was used to estimate the density of soil.

PGE Memorial Substation  
 Wilsonville, Oregon  
  
**LOG OF TEST PIT INF-02B**  
  
 March 2023      109680  
**SHANNON & WILSON, INC.**  
 Geotechnical and Environmental Consultants      **FIG. 13**

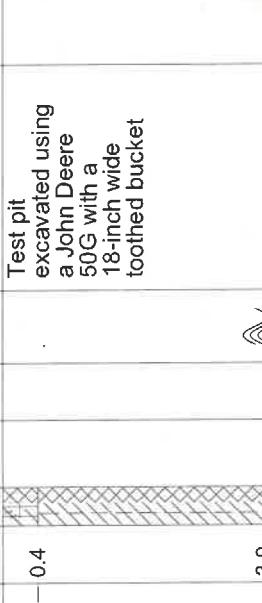

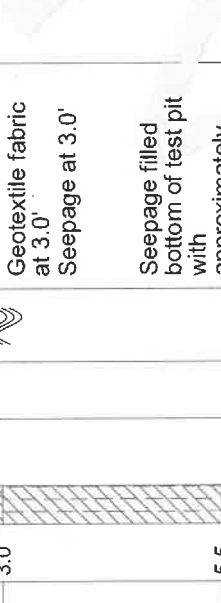
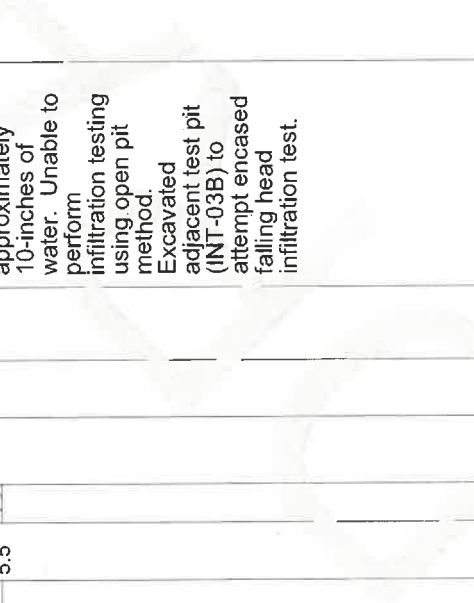
SOIL PROFILE DESCRIPTION	Depth (ft)	Symbol	Samples	Type	Ground Water	NOTES	TEST PIT PHOTOS
<p>Coordinates: N: 611,162 E: 7,618,798 Elevation: 218</p> <p><b>Topsoil</b></p> <p>Dark brown, Lean Clay (CL); moist; trace fine to coarse, angular to subrounded gravel; trace fine to coarse sand; low plasticity; trace asphalt fragments; disturbed texture.</p> <p style="text-align: center;"><b>FILL</b></p>	0.4					Test pit excavated using a John Deere 50G with a 18-inch wide toothed bucket	
<p>Gray brown mottled, Lean Clay (CL); moist; trace fine to medium sand; low plasticity; slight iron oxide staining.</p> <p style="text-align: center;"><b>MISSOULA FLOOD DEPOSITS</b></p>	3.0					Geotextile fabric at 3.0' Seepage at 3.0'	
<p>Completed: March 2, 2023</p>	5.5					Seepage filled bottom of test pit with approximately 10-inches of water. Unable to perform infiltration testing using open pit method. Excavated adjacent test pit (INT-03B) to attempt enclosed falling head infiltration test.	

**LEGEND**

 Seepage

**NOTES**

- The description in the text of this report is necessary for a proper understanding of the nature of the subsurface materials.
- Refer to Soil Classification and Log Key for explanation of "Symbols" and Definitions.
- Group symbol is based on visual-manual identification.
- Where possible, a 1/2-inch-diameter, steel T-bar probe was used to estimate the density of soil.

**FIG. 14**







PGE Memorial Substation  
Wilsonville, Oregon

**LOG OF TEST PIT INF-03A**

March 2023 109680

**SHANNON & WILSON, INC.**  
Geotechnical and Environmental Consultants

**FIG. 14**

SOIL PROFILE DESCRIPTION	Depth (ft)	Symbol	Samples	Type	Ground Water	NOTES	TEST PIT PHOTOS
<p><u>Topsoil</u> Dark brown, Lean Clay (CL); moist; trace fine to coarse, angular to subrounded gravel; trace fine to coarse sand; low plasticity; trace asphalt fragments; disturbed texture.</p> <p style="text-align: center;"><b>FILL</b></p> <p>Gray brown mottled, Lean Clay (CL); moist; trace fine to medium sand; low plasticity; slight iron oxide staining.</p> <p style="text-align: center;"><b>MISSOULA FLOOD DEPOSITS</b></p> <p>Completed: March 2, 2023</p>	0.4   3.0  5.5	     	   HA-1	   	   	<p>Test pit excavated using a John Deere 50G with a 18-inch wide toothed bucket</p> <p>Geotextile fabric at 3.0' Seepage at 3.0'</p> <p>Encased falling head infiltration test attempted at 5 feet. 12-inches of water added to casing for presoak. After 1-hour water had dropped 0.02 feet. Infiltration test terminated. Casing left in ground overnight. Water at 2.61 feet bgs on 3/3/23.</p>	

**LEGEND**

 Seepage

 Grab Sample

**NOTES**

- The description in the text of this report is necessary for a proper understanding of the nature of the subsurface materials.
- Refer to Soil Classification and Log Key for explanation of "Symbols" and Definitions.
- Group symbol is based on visual-manual identification.
- Where possible, a 1/2-inch-diameter, steel T-bar probe was used to estimate the density of soil.

PGE Memorial Substation  
Wilsonville, Oregon

**LOG OF TEST PIT INF-03B**

March 2023      109680

**SHANNON & WILSON, INC.**  
Geotechnical and Environmental Consultants      **FIG. 15**

**FIG. 15**

## Important Information About Your Geotechnical/Environmental Report

### CONSULTING SERVICES ARE PERFORMED FOR SPECIFIC PURPOSES AND FOR SPECIFIC CLIENTS.

Consultants prepare reports to meet the specific needs of specific individuals. A report prepared for a civil engineer may not be adequate for a construction contractor or even another civil engineer. Unless indicated otherwise, your consultant prepared your report expressly for you and expressly for the purposes you indicated. No one other than you should apply this report for its intended purpose without first conferring with the consultant. No party should apply this report for any purpose other than that originally contemplated without first conferring with the consultant.

### THE CONSULTANT'S REPORT IS BASED ON PROJECT-SPECIFIC FACTORS.

A geotechnical/environmental report is based on a subsurface exploration plan designed to consider a unique set of project-specific factors. Depending on the project, these may include the general nature of the structure and property involved; its size and configuration; its historical use and practice; the location of the structure on the site and its orientation; other improvements such as access roads, parking lots, and underground utilities; and the additional risk created by scope-of-service limitations imposed by the client. To help avoid costly problems, ask the consultant to evaluate how any factors that change subsequent to the date of the report may affect the recommendations. Unless your consultant indicates otherwise, your report should not be used (1) when the nature of the proposed project is changed (for example, if an office building will be erected instead of a parking garage, or if a refrigerated warehouse will be built instead of an unrefrigerated one, or chemicals are discovered on or near the site); (2) when the size, elevation, or configuration of the proposed project is altered; (3) when the location or orientation of the proposed project is modified; (4) when there is a change of ownership; or (5) for application to an adjacent site. Consultants cannot accept responsibility for problems that may occur if they are not consulted after factors that were considered in the development of the report have changed.

### SUBSURFACE CONDITIONS CAN CHANGE.

Subsurface conditions may be affected as a result of natural processes or human activity. Because a geotechnical/environmental report is based on conditions that existed at the time of subsurface exploration, construction decisions should not be based on a report whose adequacy may have been affected by time. Ask the consultant to advise if additional tests are desirable before construction starts; for example, groundwater conditions commonly vary seasonally.

Construction operations at or adjacent to the site and natural events such as floods, earthquakes, or groundwater fluctuations may also affect subsurface conditions and, thus, the continuing adequacy of a geotechnical/environmental report. The consultant should be kept apprised of any such events and should be consulted to determine if additional tests are necessary.

### MOST RECOMMENDATIONS ARE PROFESSIONAL JUDGMENTS.

Site exploration and testing identifies actual surface and subsurface conditions only at those points where samples are taken. The data were extrapolated by your consultant, who then applied judgment to render an opinion about overall subsurface conditions. The actual interface between materials may be far more gradual or abrupt than your report indicates. Actual conditions in areas not sampled may differ from those predicted in your report. While nothing can be done to prevent such situations, you and your consultant can work together to help reduce their impacts. Retaining your consultant to observe subsurface construction operations can be particularly beneficial in this respect.



## A REPORT'S CONCLUSIONS ARE PRELIMINARY.

The conclusions contained in your consultant's report are preliminary, because they must be based on the assumption that conditions revealed through selective exploratory sampling are indicative of actual conditions throughout a site. Actual subsurface conditions can be discerned only during earthwork; therefore, you should retain your consultant to observe actual conditions and to provide conclusions. Only the consultant who prepared the report is fully familiar with the background information needed to determine whether or not the report's recommendations based on those conclusions are valid and whether or not the contractor is abiding by applicable recommendations. The consultant who developed your report cannot assume responsibility or liability for the adequacy of the report's recommendations if another party is retained to observe construction.

## THE CONSULTANT'S REPORT IS SUBJECT TO MISINTERPRETATION.

Costly problems can occur when other design professionals develop their plans based on misinterpretation of a geotechnical/environmental report. To help avoid these problems, the consultant should be retained to work with other project design professionals to explain relevant geotechnical, geological, hydrogeological, and environmental findings, and to review the adequacy of their plans and specifications relative to these issues.

## BORING LOGS AND/OR MONITORING WELL DATA SHOULD NOT BE SEPARATED FROM THE REPORT.

Final boring logs developed by the consultant are based upon interpretation of field logs (assembled by site personnel), field test results, and laboratory and/or office evaluation of field samples and data. Only final boring logs and data are customarily included in geotechnical/environmental reports. These final logs should not, under any circumstances, be redrawn for inclusion in architectural or other design drawings, because drafters may commit errors or omissions in the transfer process.

To reduce the likelihood of boring log or monitoring well misinterpretation, contractors should be given ready access to the complete geotechnical engineering/environmental report prepared or authorized for their use. If access is provided only to the report prepared for you, you should advise contractors of the report's limitations, assuming that a contractor was not one of the specific persons for whom the report was prepared, and that developing construction cost estimates was not one of the specific purposes for which it was prepared. While a contractor may gain important knowledge from a report prepared for another party, the contractor should discuss the report with your consultant and perform the additional or alternative work believed necessary to obtain the data specifically appropriate for construction cost estimating purposes. Some clients hold the mistaken impression that simply disclaiming responsibility for the accuracy of subsurface information always insulates them from attendant liability. Providing the best available information to contractors helps prevent costly construction problems and the adversarial attitudes that aggravate them to a disproportionate scale.

## READ RESPONSIBILITY CLAUSES CLOSELY.

Because geotechnical/environmental engineering is based extensively on judgment and opinion, it is far less exact than other design disciplines. This situation has resulted in wholly unwarranted claims being lodged against consultants. To help prevent this problem, consultants have developed a number of clauses for use in their contracts, reports, and other documents. These responsibility clauses are not exculpatory clauses designed to transfer the consultant's liabilities to other parties; rather, they are definitive clauses that identify where the consultant's responsibilities begin and end. Their use helps all parties involved recognize their individual responsibilities and take appropriate action. Some of these definitive clauses are likely to appear in your report, and you are encouraged to read them closely. Your consultant will be pleased to give full and frank answers to your questions.

**The preceding paragraphs are based on information provided by the GBA, Silver Spring, Maryland**

Page intentionally left blank for double-sided printing.

# Appendix E

Plans

Page intentionally left blank for double-sided printing.







INTERSTATE 5 HIGHWAY

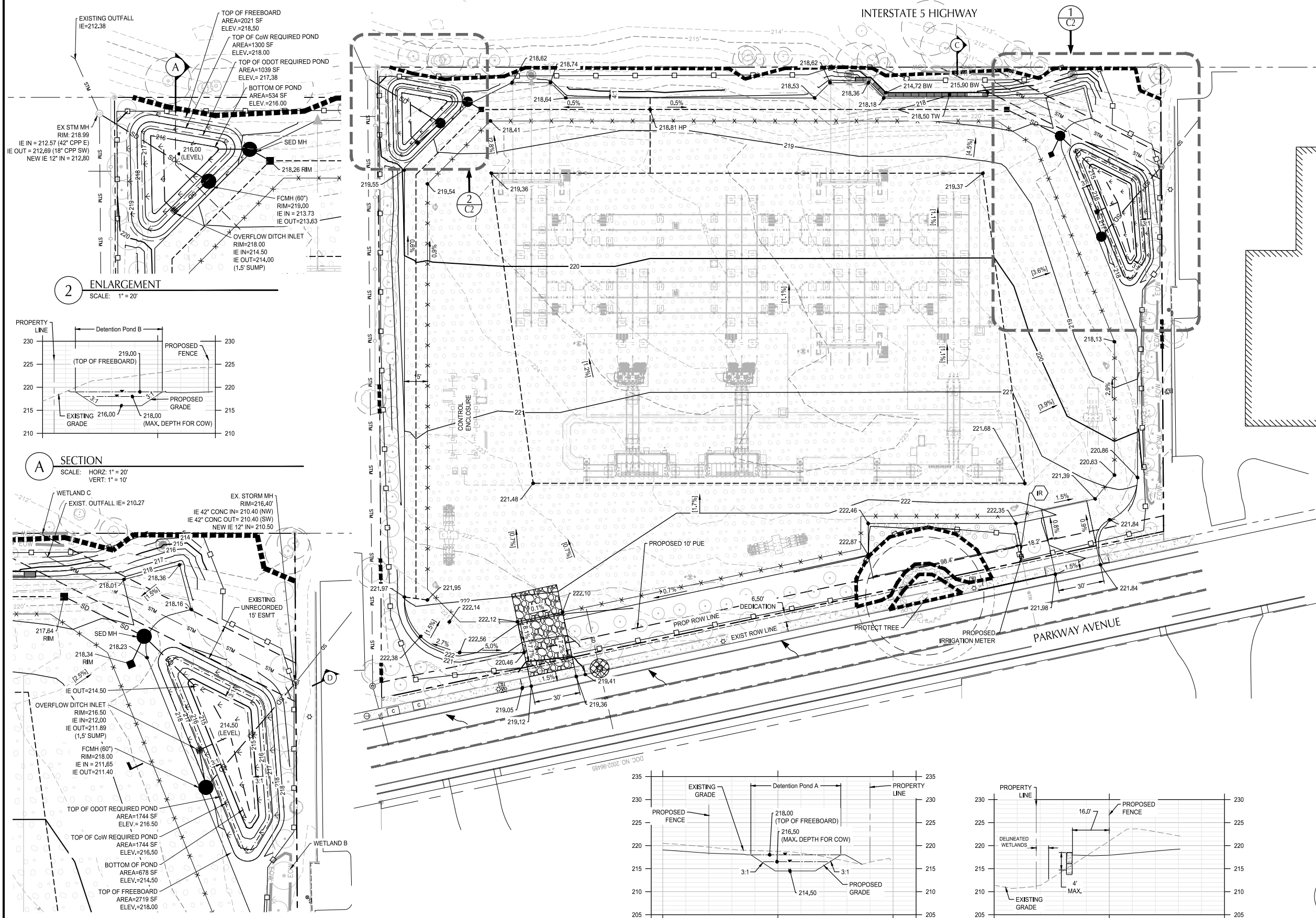

- SHEET NOTES**
- SLOPES PROVIDED ON SLOPE ARROW ARE FOR REFERENCE ONLY.
  - SITE IS NOT PROPOSING ANY NEW UTILITY CONNECTIONS.
  - SITE IS NOT OPEN TO THE PUBLIC AND IS NOT PROPOSING ANY PARKING FACILITIES.
  - SITE IS NOT ANTICIPATED TO GENERATE ANY NEW VEHICULAR, CYCLIST OR PEDESTRIAN USERS.

- CALLOUT LEGEND**
- | CALLOUT | DESCRIPTION  |
|---------|--|
| X.X%    | GRADING SLOPE AND DIRECTION (DOWNHILL)                             |
| [X.X%]  | SLOPE ORIENTATION INDICATING DIRECTION OF MAXIMUM GRADE (DOWNHILL) |
| XX.XX   | SPOT ELEVATION   |
| IR      | PROPOSED IRRIGATION  |

- SHEET LEGEND**
- |         |  |
|---------|--|
| ---     | PROPERTY LINE                                  |
| - - - - | EASEMENT LINE                                  |
| - - - - | GRADE BREAK                                    |
| ---     | EX. CONTOUR MINOR                              |
| ---     | EX. CONTOUR MAJOR                              |
| ---     | CONTOUR MINOR (FG)                             |
| ---     | CONTOUR MAJOR (FG)                             |
| ---     | CUT FILL LINE                                  |
| X X X X | PROPOSED FENCE                                 |
| SD SD   | PROPOSED STORM DRAIN PIPE                      |
| ●       | PROPOSED MANHOLE                               |
| ■       | PROPOSED OVERFLOW INLET                        |
| ■       | PROPOSED CATCH BASIN                           |
| [ ]     | PROPOSED DETENTION POND PER COW DETAIL ST-6065 |
| [ ]     | PROPOSED GRAVEL SURFACING                      |
| [ ]     | BLOCK RETAINING WALL                           |
| [ ]     | GRAVEL CONSTRUCTION ENTRANCE                   |
| [ ]     | SEDIMENT FENCE OR STRAW WATTLES                |
| [ ]     | TREE PROTECTION FENCE, SEE LANDSCAPE PLANS     |
| [ ]     | INLET PROTECTION                               |
| [ ]     | EXISTING TREE WITH ROOT PROTECTION ZONE        |

**2 ENLARGEMENT**  
SCALE: 1" = 20'

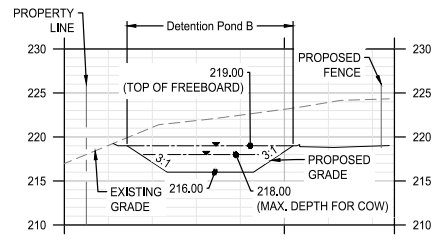

**A SECTION**  
SCALE: HORZ: 1" = 20'  
VERT: 1" = 10'

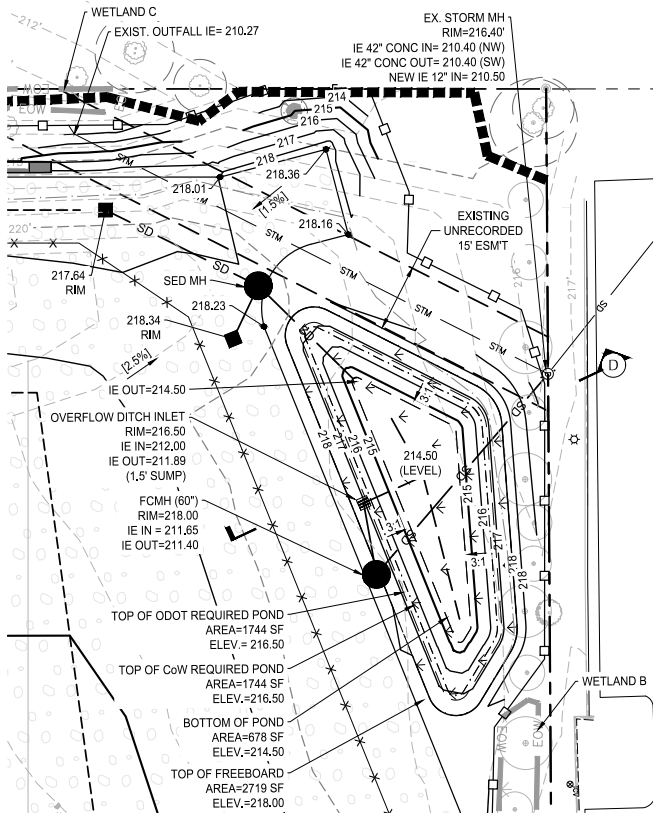

**1 ENLARGEMENT**  
SCALE: 1" = 20'

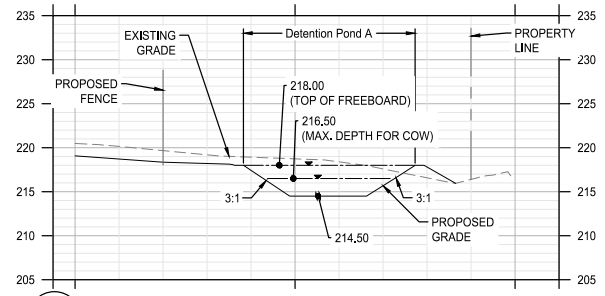

**D SECTION**  
SCALE: HORZ: 1" = 20'  
VERT: 1" = 10'

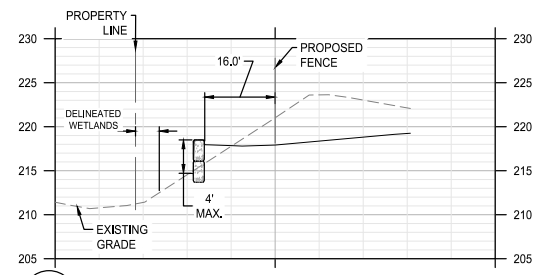

**C SECTION**  
SCALE: HORZ: 1" = 20'  
VERT: 1" = 10'

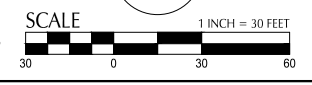

File: \\p01\p01\Projects\2022\220448-02-grading\substation\CAD\PL\020448-02-GRADING-LU.dwg TAB C2  
 Plotted: 10/24/23 at 3:39pm By: RCadua

REVISION	DATE	DESCRIPTION	BY



JOB No.:	2200448
DESIGNED BY:	TL, BC
DRAWN BY:	TL, RC
CHECKED BY:	JL
PLOT DATE:	10/24/23 3:39pm
PLOTTED BY:	RCadua
DWG NAME:	204802GRADING-LU.dwg
TAB NAME:	C2



PORTLAND GENERAL ELECTRIC CO. - 121 SW SALMON ST., PORTLAND, OR 97204

**MEMORIAL SUBSTATION**  
CONCEPT PLAN  
27601 SW PARKWAY AVENUE, WILSONVILLE, OR 97070

**GRADING AND UTILITY PLANS**

**C2**

SHEET COUNT

SHEET NO.



# Appendix F

## Downstream Analysis

# Memorandum

July 28, 2023



PROJECT: 10102200448-PGE Memorial Substation

SUBJECT: Downstream Analysis

## Introduction

On July 19<sup>th</sup>, 2023, KPFF conducted a downstream inspection of the conveyance for the proposed PGE Memorial Substation project, per the City of Wilsonville standards. This proposed development is located on the west side of Parkway Avenue north of SW Boeckman Road and East of I-5, as shown in Figure 1.

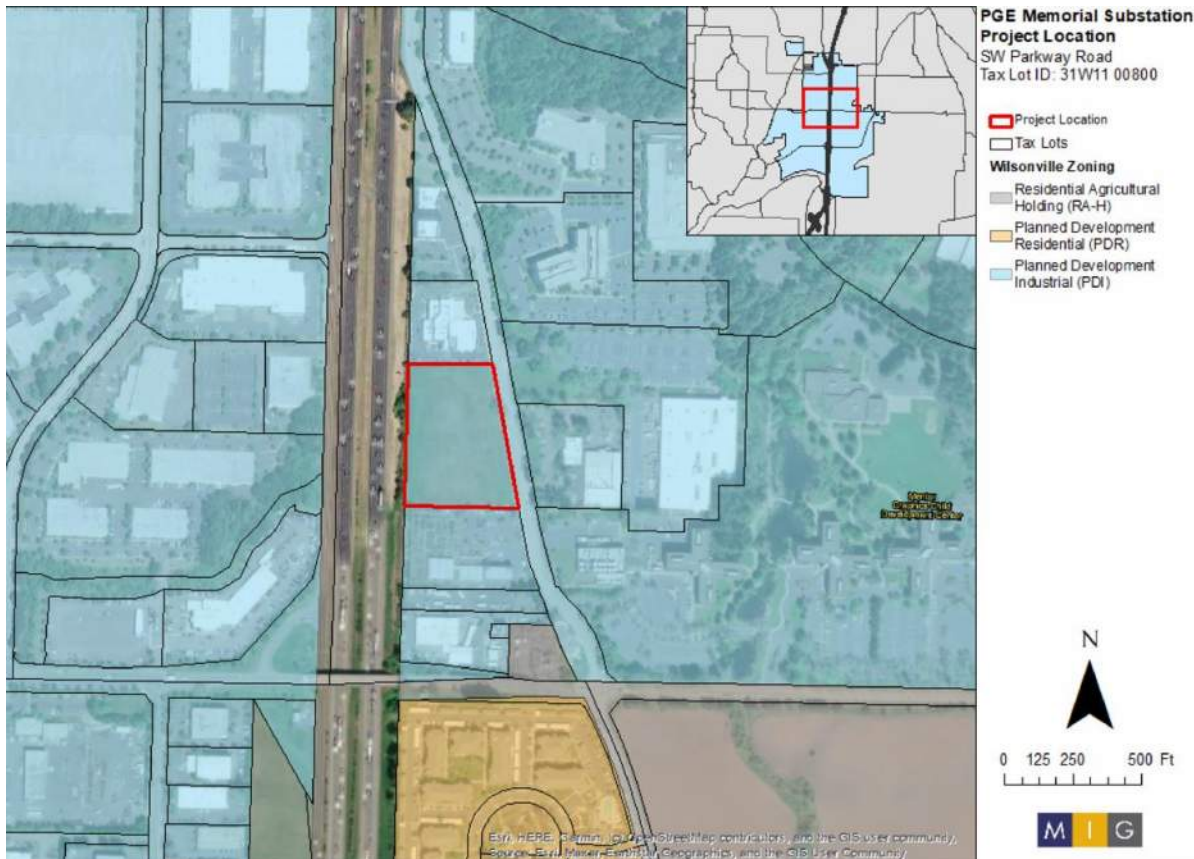

**Figure 1 Vicinity Map**

The development is required to perform a downstream analysis that meets the requirements of the City of Wilsonville Public Work Standards Section 301.5.01., specifically the downstream analysis shall include:

- Verifying that the downstream system has the capacity to convey the 25-year design storm.
- Extending the analysis downstream to a point in the drainage system where the proposed development site contributes 10% or less of the total tributary drainage flow or one-quarter mile downstream of the approved point of discharge. The former was applied to the extents of the study and basins are shown in Attachment B1.

## Existing Conveyance System

The existing conveyance system used in this analysis is shown in Attachment B2, which also includes drainage basin delineation, time of concentration (Tc) flow paths, and runoff node locations represented in the hydraulic model. Details of the downstream conveyance system used to create the hydraulic model were primarily obtained from City GIS as-built information and field observation. The proposed PGE Memorial Substation development will discharge runoff into the existing Coffee Lake Creek Basin West of the site across I-5.



# Memorandum

July 28, 2023



PGE Memorial property and contributing basins outfall to the west side of I-5 via a 42-inch pipe and pass under I-5 via a 24-inch culvert (A) west of the site and as a secondary path of drainage to an 18-inch culvert (B) southeast of the project site.

The 24-inch culvert (A) was overgrown, and the condition is not observed, but per ODOT as-builts the culvert passes under I-5 to a wooded area for approximately 673-feet. Beyond the analysis limit the wooded area drains to a 36-inch culvert (C) which then extends to an additional 678-feet of wooded grassy area. The water is then conveyed to Coffee Lake Creek and ultimately to Willamette River.

The secondary path for the outfall is south through tall grass for approximately 535-feet to SW Boeckman Road. Also, outside of the limits of analysis, the 18-inch culvert (B) runs parallel to SW Boeckman Road and under I-5. The west end of the culvert crosses I-5 and then conveys in a grass channel to another 18-inch culvert and flows south from there. Along the south side of Boeckman Road west of I-5, the flow then travels into a grassy rock ditch.

The proposed development for this site is located above the 100-year floodplain delineated in the Flood Insurance Rate Map (FEMA, 2008) and in the non-printed unmapped Flood Map Boundary Area. See Attachment D for the FIRMette corresponding to the proposed site.

## Field Visit and Assessment

The field study extended past the 10% limits shown on Attachment B1, see Attachment A for photos and the photo map. The project site is currently a grass lot located in both sub-basin 1726 and sub-basin 4012. The proposed PGE Memorial Substation basin drains primarily west across I-5 via culvert (A) to a wooded landscape and secondarily downstream south towards SW Boeckman Road and then through culvert (B) parallel to Interstate 5.

The stretch of channel downstream of the project site was visited on July 19, 2023, during a relatively dry summer season. The field assessment started at the outfall just outside of the northwest corner of the site and extended into two different directions, 0.3 miles and 0.23 miles downstream respectively. During the site assessment, the outfall shown in Photo 01 in Attachment A was found surrounded by overgrown invasive species. The outfall was measured at 42-inch diameter and had a water depth of 6.5-inches.

Photo 02 shows the 24-inch Culvert A inlet area with overgrown vegetation preventing visual inspection. Therefore, dimensions per ODOT as-builts (Attachment E) were utilized for analysis. The culvert's area location primarily consisted of dry vegetation and other debris from Interstate-5 and approximately 4-inches of standing water. The 24-inch outlet of culvert A was also not found on the west side of I-5, as it was similarly covered in overgrowth and trimmings, see photo 11. The assumed location of the outfall was then followed downstream and a small creek with heavy sediment and less than 2-inches of water was found to be typical see photos 12 A & B. Continuing downstream to the 54-inch culvert C shown in pictures 13 and 14 A was found with no water, heavy grass, and rip rap out falling to tall grass shown in picture 14B.

Heading south from the project site along I-5 is a small ditch with heavy sediment and less than 2-inches of water was found approximately 60-feet south of the site, see photo 3. This continues into a dry creek bed with tall grass, see photo 4, and then transfers back into a small creek with heavy sediment and approximately 2-inches of water, see photo 5. The flow then collects into 18-inch Culvert B located on the east side of I-5 just north of SW Boeckman Road, see photo 6. Culvert B was found to have less than 1-inch of standing water and was overgrown with invasive species. On the west side of I-5, the 18-inch culvert B was again covered with overgrowth with 7-inches of standing water, see photo 7. The flow then goes through a grass channel to another 18-inch culvert headed south, see photo 8. The outfall of the 18-inch is nearly submerged and crushed see photo 9. Photo 10 appears to show an overflow pipe from the City well building.

# Memorandum

July 28, 2023



Table 1: Downstream Impact Analysis - Drainage System Table

<b>Node</b>	<b>Drainage Component</b>	<b>Contributing Drainages</b> (See Figure 2 for referenced basins)	<b>Existing Problems</b>	<b>Potential Problems</b>	<b>Observations</b> (Referenced Photos are in Appendix A)
Outfall	Public storm main outfall at NW corner of PGE Memorial property adj. to ODOT ROW (42-inch dia. steel pipe)	<b>Basin 1726 and Project Site</b>	None	None	Outfall drains into a shallow channel located adjacent to the east side of I-5 and the northwest corner of the property. The channel is in good condition without indicators of degradation. Standing water of approximately 6.5-inches ( <b>Photo 01</b> )
Culvert A	Existing 24-inch diameter, ~400-ft long crossing under I-5. Assumed concrete and slope 0.33%	<b>Basin 1726 and Site</b>	no issues beyond excessive vegetation preventing inspection	None	Culvert was not found due to overgrowth on both the west and east side of I-5. (Photo 02)
Culvert B	Existing 18-inch dia. 288-ft long concrete culvert at SW Boeckman crossing under I-5	<b>Basin 4012 and Site</b>	None	None	Moderately deep natural channel on the east side of I-5 heavily vegetated with 1/2-inch standing water. The natural channel on the west side is heavily vegetated with 7-inch standing water. ( <b>Photos 06 – 07</b> )
Culvert C	Existing 54-inch diameter, 100-foot long crossing under Toyota roadway	<b>Basin 2720</b>	None	None	A shallow natural channel on the east side of the culvert with some surrounding vegetation, rip-rap, and no standing water. A shallow natural channel on the west side with less surrounding vegetation and no standing water. ( <b>Photos 13–14</b> )

## Conveyance Hydrology

Peak runoff rates from the drainage basins delineated in Attachment B2, during existing and proposed conditions were calculated using Hydraflow Hydrograph see Attachment C. The Santa Barbara Urban Hydrograph (SBUH) method was used to apply the conveyance design event (25-year recurrence interval, 24-hour duration, NRCS Type 1A rainfall distribution), per Section 301.5.01. Time of Concentration values were calculated for each delineated drainage basin using TR-55 equations. Time of Concentration (Tc) flow paths are shown in Attachment B2 and corresponding calculations for each drainage basin are included in Attachment C. The Hydraflow Hydrograph peak flows and time of concentration for basins going up to the existing 24-inch Culvert A are a Tc of 25.90 min and peak discharge was 10.87 cfs while the existing Culvert B had a Tc of 25.90 min and a peak discharge of 8.096 cfs.



# Memorandum

July 28, 2023

Page 4 of 13



Most of the study area is comprised of silt loam categorized in the hydrologic soil group (HSG) C/D. HSG C/D soils generally exhibit slow to very slow infiltration rates when thoroughly wet. A small area at the western limits of sub-basin 2720 is categorized as HSG C with low to moderate infiltration. This area lies beyond the extent of the downstream analysis. A Curve Number (CN) of 98 was used for all impervious areas. The pervious areas were mostly densely vegetated with trees, blackberry bushes, tall grass, and invasive species, thus a CN of 61 (HSG B), 74 (HSG C), or 80 (HSG D) was used as applicable.

The basins downstream of the proposed project site are primarily developed commercial areas. Impervious percentages were estimated based on existing impervious surfaces captured in July 2022 aerial imagery. Attachment B2 shows both the time of concentration (TOC) flow paths and the basins they cross. The first TOC path begins in sub-basin 1726 and crosses into sub-basin 2720. Both sub-basins are currently comprised of commercial buildings, highway and road areas, parking lots, and some vegetation areas. The northern half of the project site is located within the southern portion of sub-basin 1726. The second TOC path as well as the southern part of the project site lies within sub-basin 4012. Similarly, sub-basin 4012 is mostly commercial buildings, highway and road areas, parking lots, and little vegetation areas.

## Downstream Conveyance Modeling Analysis

The stormwater conveyance network was analyzed in Hydraflow Express Extension. The conveyance system was modeled to determine whether the existing downstream system has sufficient capacity to support the PGE memorial development runoff during the 25-year, 24-hour storm event. A Manning's n value of 0.012 was applied to the storm conveyance pipes in the network. A value of 0.04 was applied to the channel and 0.08 was applied to the banks of the open channel reach of Willow Creek downstream of SW Willow Creek Drive. A minimum of one-foot of freeboard between the hydraulic grade line (HGL) and the structure rim elevations was confirmed; therefore, it is assumed that adequate capacity exists.

Attachment C includes the output information from the Hydraflow Express Extension, summarizing the culvert characteristics and results of the hydraulic routing during the design storm. The existing Culvert A does not overtop the road. The headwater depth at Culvert B experiences some overflow but also does not overtop the road.

## Conclusions

The downstream stormwater conveyance system analyzed as part of this downstream analysis extends from the proposed development site and contributes 10% of the total tributary drainage flow. The system consists of both open channel and piped conveyance components. A site visit along the downstream reach provided a qualitative assessment of the storm conveyance system and found no evidence of capacity restrictions under existing conditions.

The storm sewer was modeled using Hydraflow software and shows adequate capacity for the proposed flows. Lots and roadways adjacent to the channel are raised and stormwater is expected to be confined. The culverts beneath SW Boeckman Road were modeled using Hydraflow software, and minimal headwater created will not overtop the roadways.

The proposed development will detain high flows on site, maintaining Pre-development flow rates.

## Attachments:

- Attachment A – Photo Map & Site Photos
- Attachment B1 – Analysis Limits Map
- Attachment B2 – Basins & TOC Map
- Attachment C – Conveyance Calcs
- Attachment D - FIRM-Map
- Attachment E – ODOT As-builts

# Memorandum

July 28, 2023  
Page 5 of 13



## Attachment A: PGE Memorial Photo Log



Photo 01: PGE Memorial 42-inch outfall with a 6.5-inch water depth.



Photo 02: Culvert A 24-inch Not found. Heavily vegetated with tall grass, blackberry bushes, and other invasive species.



# Memorandum

July 28, 2023  
Page 6 of 13



*Photo 01: Downstream of Outfall. Heavily vegetated with invasive species. Typical conditions with a 3-inch water depth.*



*Photo 02: General area of the unfound outfall. The area was covered in overgrown vegetation, mostly tall grass.*



# Memorandum

July 28, 2023  
Page 7 of 13



Photo 03: Downstream standing water depth of 4-inches with thick sediment and surrounding tall grass.



Photo 04: The heavily vegetated area surrounding 18-inch culvert B, located east of Interstate 5 and north of Boeckman Road.



# Memorandum

July 28, 2023  
Page 8 of 13



Photo 05: Overgrown invasive species surrounding 18-inch culvert B, located west of Interstate 5 and north of Boeckman Road.



Photo 06: Heavily vegetated area surrounding 18-inch culvert heading south, located west of Interstate 5 and north of Boeckman Road.

# Memorandum

July 28, 2023  
Page 9 of 13



*Photo 07: 18-inch Culvert partially crushed and with 10-inches of standing water. Located west of Interstate 5 and south of Boeckman Road*



# Memorandum

July 28, 2023  
Page 10 of 13



Photo 8: 14-inch cast iron pipe to well adjacent to culvert pictured in Photo 9. Located west of Interstate 5 and south of Boeckman Road.



Photo 9: General location of unfound 24-inch A culvert. The area was surrounded by dry vegetation and other debris from the highway.



# Memorandum

July 28, 2023

Page 11 of 13



Photo 10.A: Facing NE downstream of unfound culvert in a wooded landscape. Typical conditions with heavy sediment and a water depth of 1.5-inches.



Photo 12.B: Facing SW downstream of unfound culvert in a wooded landscape. Typical conditions with heavy sediment and a water depth of 1-inch.



# Memorandum

July 28, 2023  
Page 12 of 13



Photo 11: East side of 54-inch culvert surrounded with rip rap and invasive species.



Photo 12.A: West side of 54-inch culvert.

# Memorandum

July 28, 2023

Page 13 of 13



*Photo 14.B: Surrounding area of west side of the 54-inch culvert.*



# PGE MEMORIAL DOWNSTREAM ANALYSIS PHOTO MAP

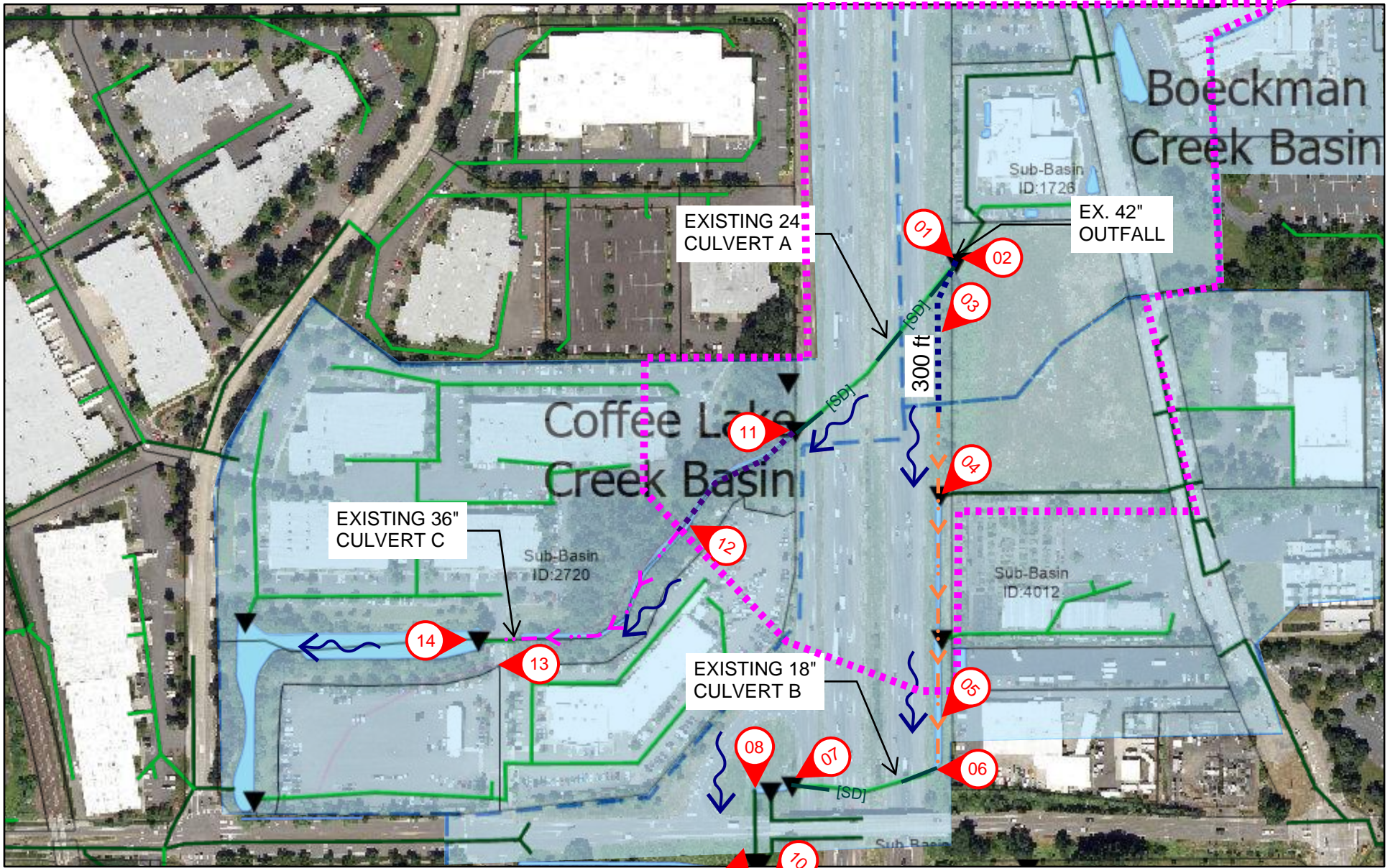

- X \

- 5/6 7D[ORWV
- 6WRUPZDWHU 0
- 6WRUPZDWHU 2XWO
- 3ULYDWH \$FWL
- REQUIRED ANALYSIS LIMITS

**PHOTO KEY**

Photo # and direction

PL  
NP  
(VUL &RPPXQLW) ODSV &RQWULEXWRUV 2UHJRO OHW  
6WDWH RI 2UHJRO \*(2 k 2SHQ6WUHHWODS 0LFURVRI



# PGE MEMORIAL DOWNSTREAM DOWNSTREAM ANALYSIS LIMITS & BASINS

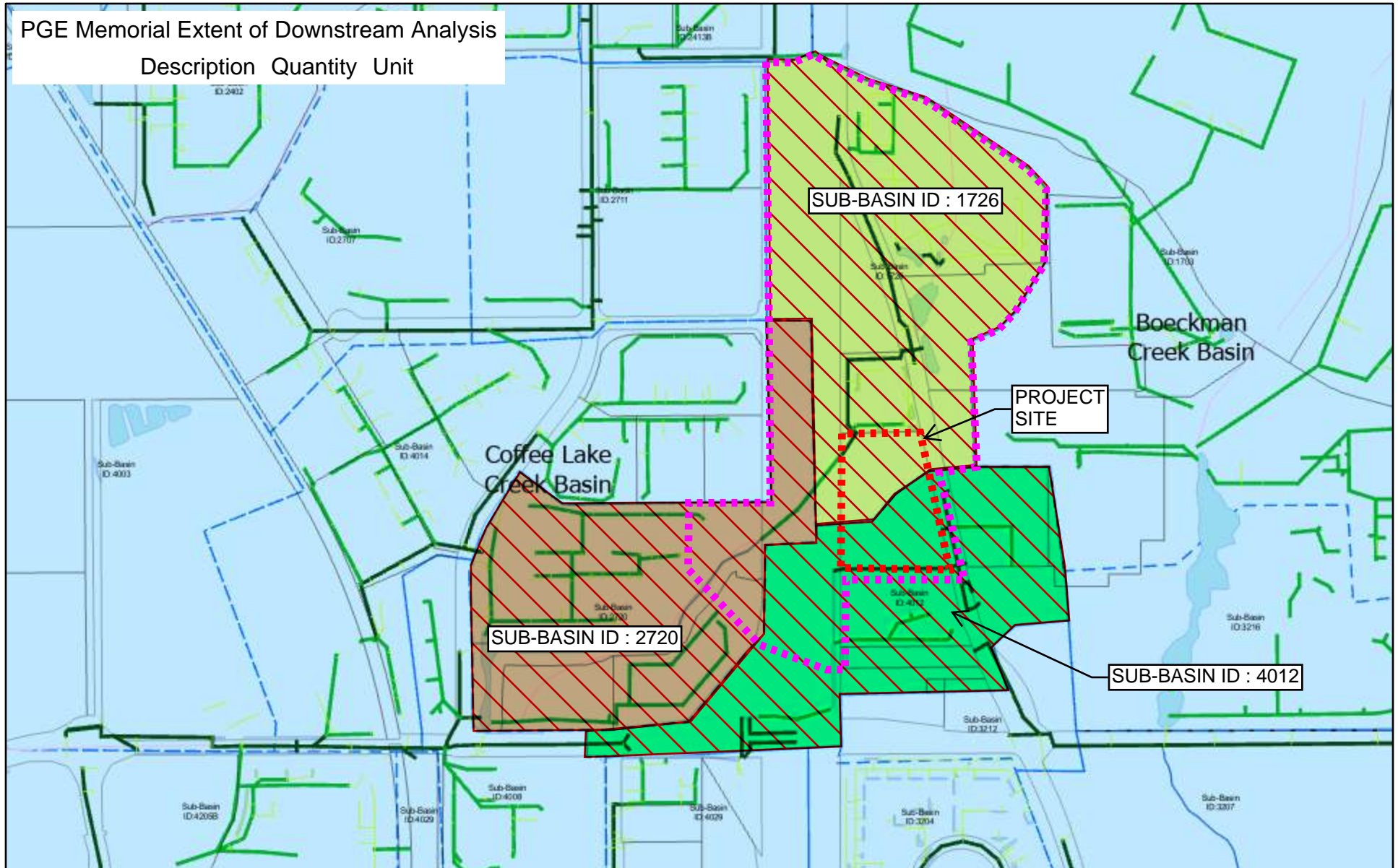

PGE Memorial Extent of Downstream Analysis  
Description Quantity Unit

- X O \

- 5/,6 7D[ORWV 6WRUPZDWHU 0E 06 QNH 206 DWHU %052 EQ6WUHDPV
- 6WRUPZDWHU /DWHU 0X6 0 2 0 6 \$FW LYH & LW \ /LPLWV 2 , QWHUPLWWHQW
- 3ULYDWH \$ FWL Y8H% 2 3HUHQQLDO

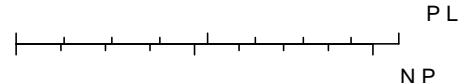

(VUL &RPPXQLW\ ODSV &RQWULEXRUV 2UHJRO 0HW  
6WDWH RI 2UHJRO \*(2 k 2SHQ6WUHHW0DS 0LFURVRI



# PGE MEMORIAL DOWNSTREAM ANALYSIS TOC D O \ V L V 7 2 &

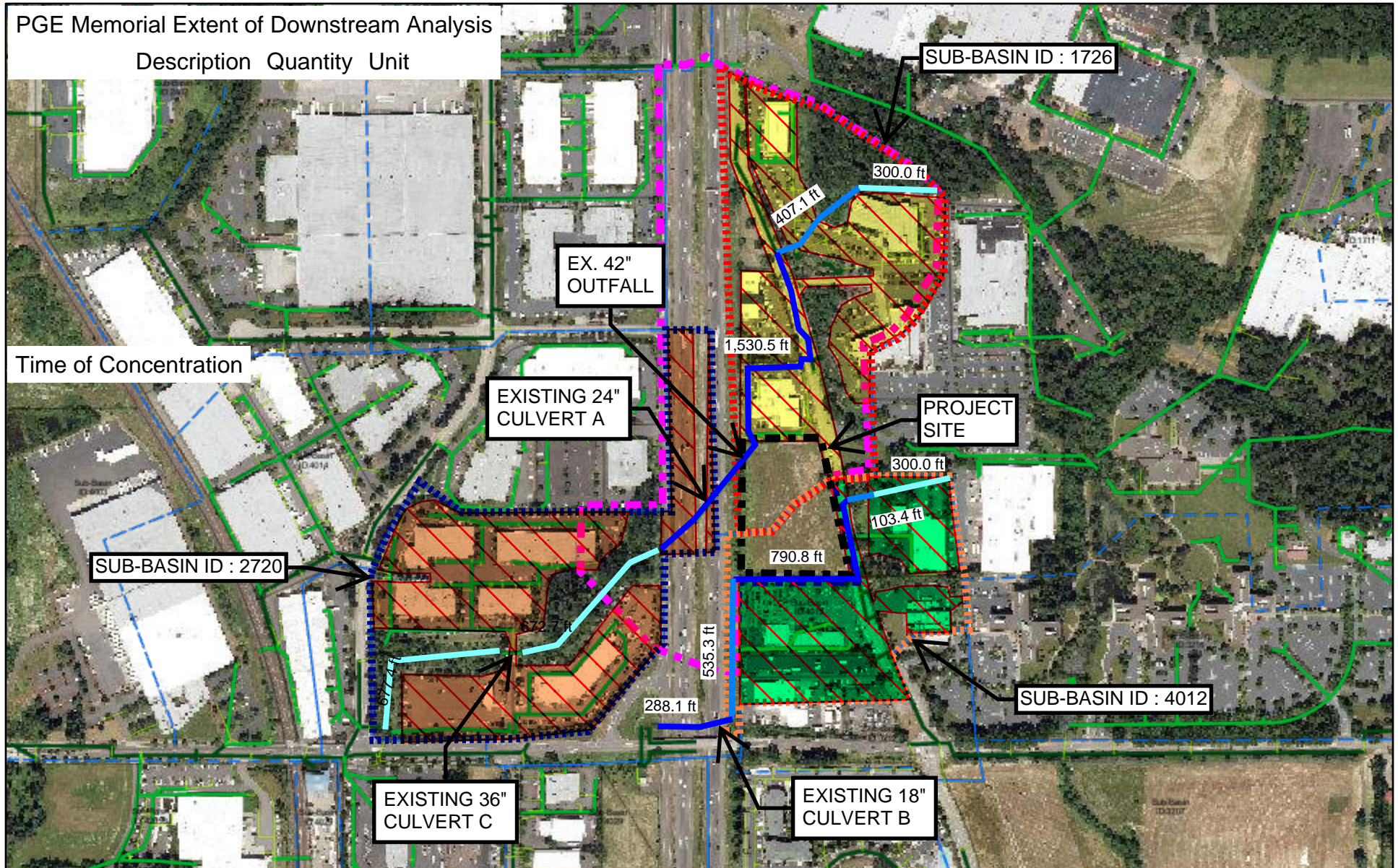

- X O \

- 5/,6 7D[ORWV 6WRUPZDWHU 0L QO & L W 20 PLWV - X O \ 3KRWR
- 6WRUPZDWHU /DWHU 0L QO & L W 20 PLWV 5HG %DQGB
- 3ULYDWH \$FWLYH 6WRUPZDWHU 6XELVLUH 206%DQGB
- REQUIRE ANALYSIS LIMITS

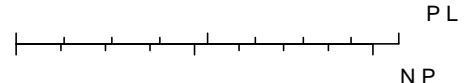

(VUL & RPPXQLW) ODSV & RQWULEXWRUV 2UHJRO 0HW  
6WDWH RI 2UHJRO \*(2 k 2SHQ6WUHHWODS 0LFURVRI

# Culvert Report

Hydraflow Express Extension for Autodesk® Civil 3D® by Autodesk, Inc.

Wednesday, Jul 26 2023

## Culvert A

Invert Elev Dn (ft)	= 0.10
Pipe Length (ft)	= 422.00
Slope (%)	= 0.33
Invert Elev Up (ft)	= 1.48
Rise (in)	= 24.0
Shape	= Circular
Span (in)	= 24.0
No. Barrels	= 1
n-Value	= 0.012
Culvert Type	= Circular Concrete
Culvert Entrance	= Square edge w/headwall (C)
Coeff. K,M,c,Y,k	= 0.0098, 2, 0.0398, 0.67, 0.5

### Embankment

Top Elevation (ft)	= 8.00
Top Width (ft)	= 200.00
Crest Width (ft)	= 0.00

### Calculations

Qmin (cfs)	= 10.87
Qmax (cfs)	= 10.87
Tailwater Elev (ft)	= (dc+D)/2

### Highlighted

Qtotal (cfs)	= 10.87
Qpipe (cfs)	= 10.87
Qovertop (cfs)	= 0.00
Veloc Dn (ft/s)	= 4.06
Veloc Up (ft/s)	= 5.63
HGL Dn (ft)	= 1.69
HGL Up (ft)	= 2.66
Hw Elev (ft)	= 3.27
Hw/D (ft)	= 0.89
Flow Regime	= Inlet Control

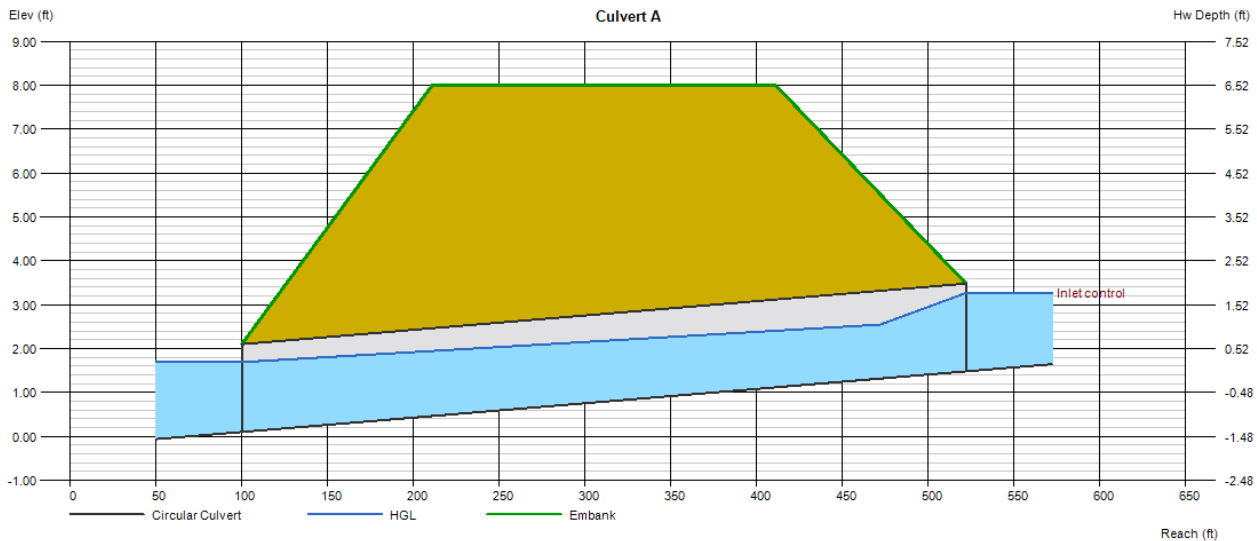



# Hydrograph Report

Hydraflow Hydrographs Extension for Autodesk® Civil 3D® by Autodesk, Inc. v2022

Thursday, 07 / 27 / 2023

## Hyd. No. 1

### Culvert A

Hydrograph type	= SBUH Runoff	Peak discharge	= 10.87 cfs
Storm frequency	= 25 yrs	Time to peak	= 8.08 hrs
Time interval	= 5 min	Hyd. volume	= 210,642 cuft
Drainage area	= 22.800 ac	Curve number	= 87*
Basin Slope	= 0.0 %	Hydraulic length	= 0 ft
Tc method	= TR55	Time of conc. (Tc)	= 25.90 min
Total precip.	= 3.90 in	Distribution	= Type IA
Storm duration	= 24 hrs	Shape factor	= n/a

\* Composite (Area/CN) = [(13.200 x 98) + (9.600 x 74)] / 22.800

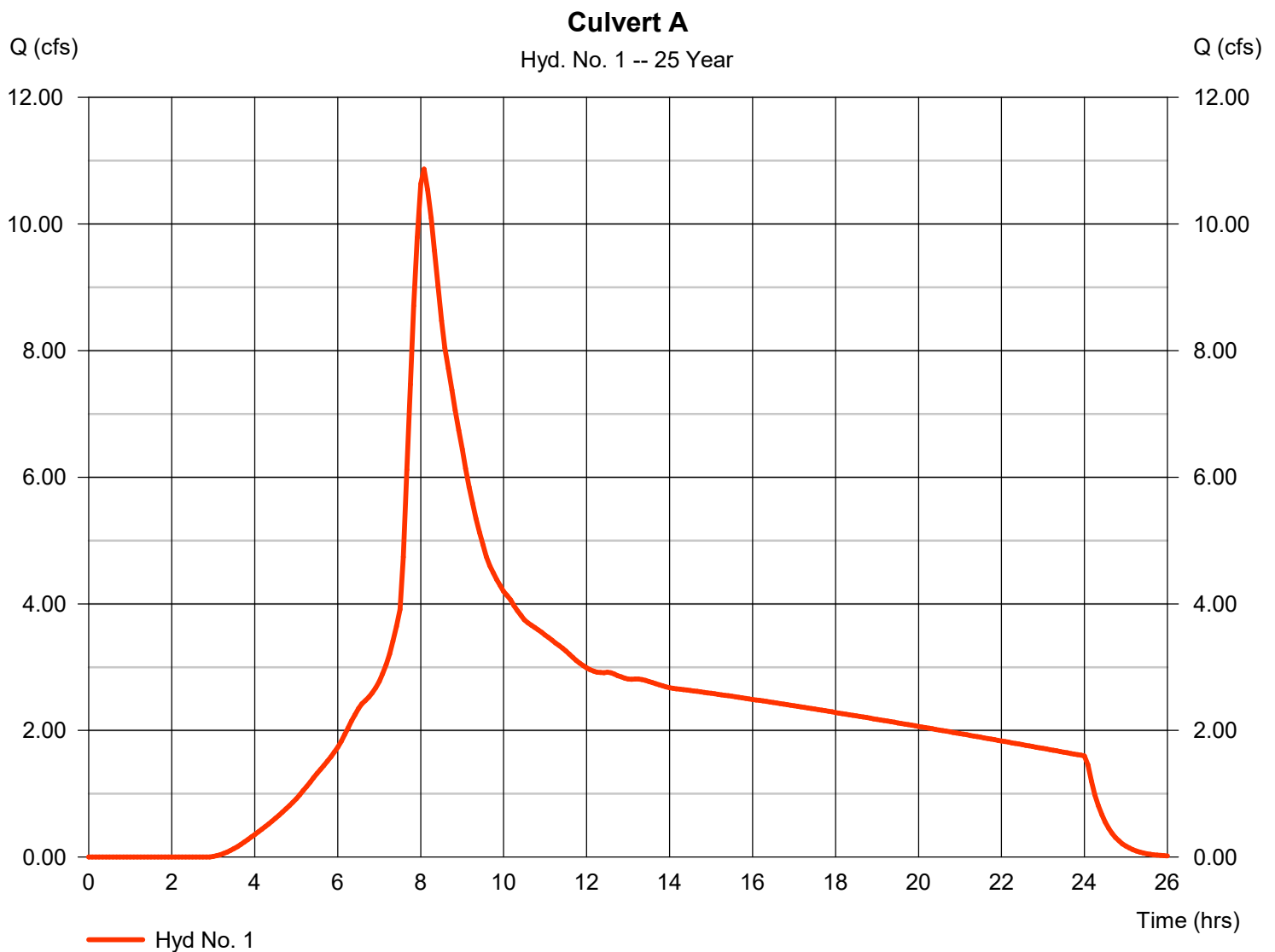

# Culvert Report

Hydraflow Express Extension for Autodesk® Civil 3D® by Autodesk, Inc.

Wednesday, Jul 26 2023

## Culvert B

Invert Elev Dn (ft)	= 0.10
Pipe Length (ft)	= 276.00
Slope (%)	= 0.50
Invert Elev Up (ft)	= 1.48
Rise (in)	= 18.0
Shape	= Circular
Span (in)	= 18.0
No. Barrels	= 1
n-Value	= 0.012
Culvert Type	= Circular Concrete
Culvert Entrance	= Square edge w/headwall (C)
Coeff. K,M,c,Y,k	= 0.0098, 2, 0.0398, 0.67, 0.5

### Embankment

Top Elevation (ft)	= 5.00
Top Width (ft)	= 240.00
Crest Width (ft)	= 0.00

### Calculations

Qmin (cfs)	= 8.08
Qmax (cfs)	= 8.50
Tailwater Elev (ft)	= (dc+D)/2

### Highlighted

Qtotal (cfs)	= 8.08
Qpipe (cfs)	= 8.08
Qovertop (cfs)	= 0.00
Veloc Dn (ft/s)	= 4.97
Veloc Up (ft/s)	= 5.82
HGL Dn (ft)	= 1.40
HGL Up (ft)	= 2.58
Hw Elev (ft)	= 3.31
Hw/D (ft)	= 1.22
Flow Regime	= Inlet Control

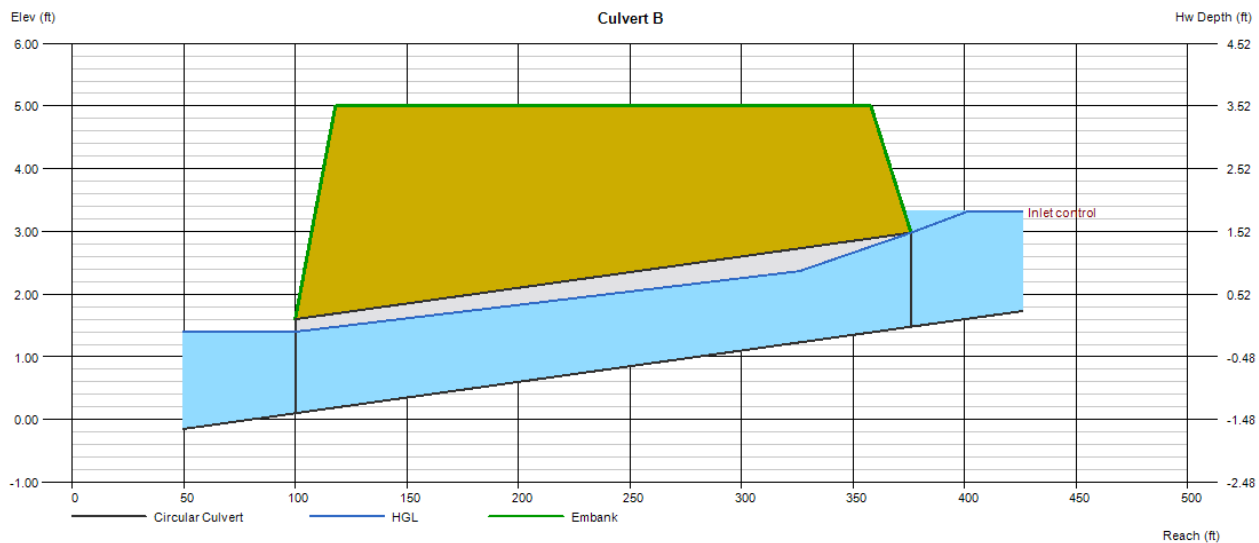

# Hydrograph Report

Hydraflow Hydrographs Extension for Autodesk® Civil 3D® by Autodesk, Inc. v2022

Thursday, 07 / 27 / 2023

## Hyd. No. 2

### Culvert B

Hydrograph type	= SBUH Runoff	Peak discharge	= 8.096 cfs
Storm frequency	= 25 yrs	Time to peak	= 8.08 hrs
Time interval	= 5 min	Hyd. volume	= 152,767 cuft
Drainage area	= 14.900 ac	Curve number	= 90*
Basin Slope	= 0.0 %	Hydraulic length	= 0 ft
Tc method	= TR55	Time of conc. (Tc)	= 25.90 min
Total precip.	= 3.90 in	Distribution	= Type IA
Storm duration	= 24 hrs	Shape factor	= n/a

\* Composite (Area/CN) = [(10.000 x 98) + (4.900 x 74)] / 14.900

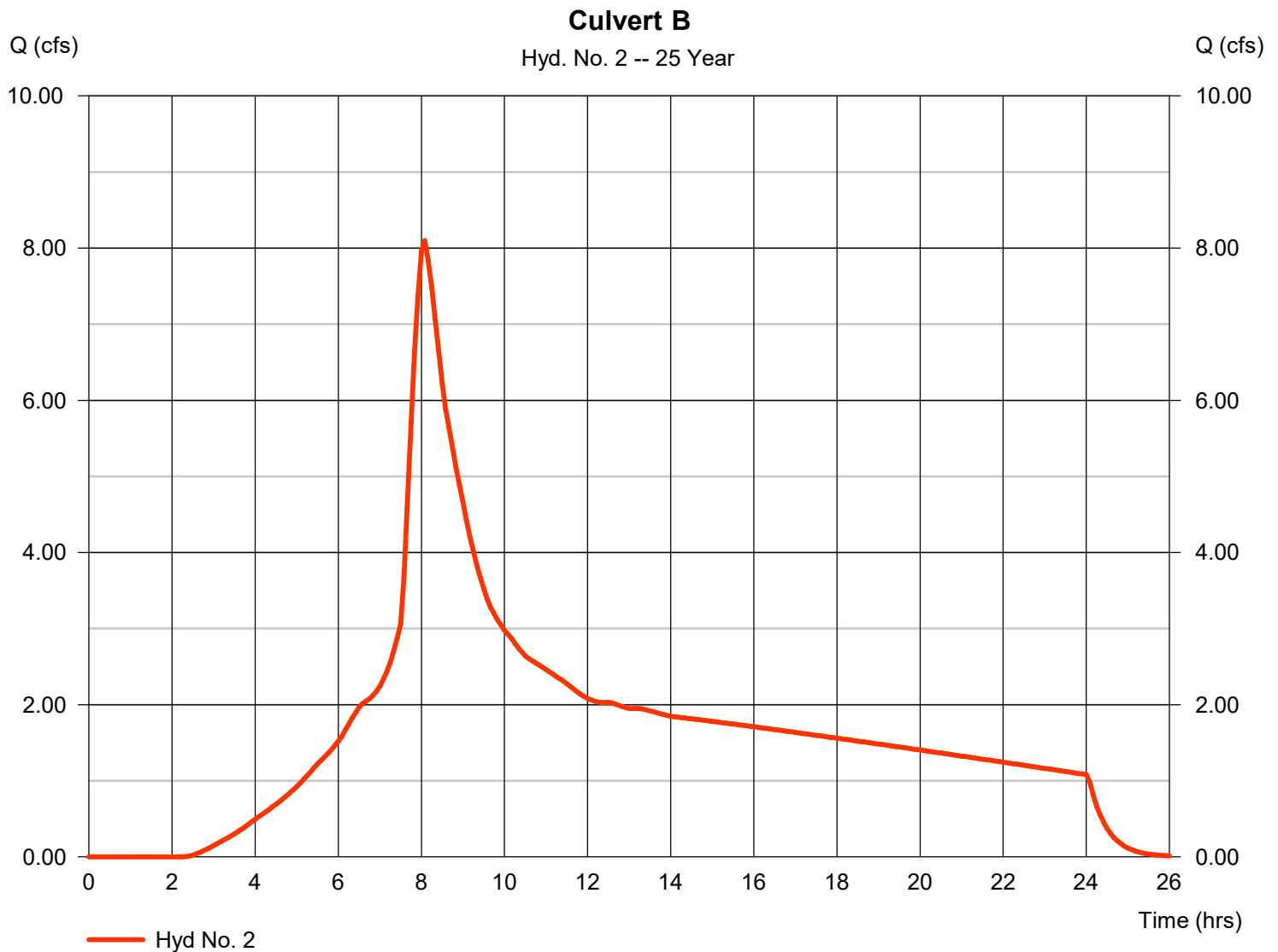







T.3 S., R.1 W., W.M. Revised 5-12-69: Corrected Surfacing Thickness

EAST PORTLAND FRWY-WILSONVILLE INTCHGE. SEC.				
PACIFIC HIGHWAY				
WASHINGTON & CLACKAMAS COUNTIES				
FED. ROAD Div. No.	STATE	PROJECT NUMBER	LOCAL YEAR	SHEET NO.
8	OREGON	15-544285		8
				TOTAL SHEETS
				31

REVISED AS CONSTRUCTED 7/27/72 CONTRACT 9-10-74

Sta 458+03 to Sta 474+24  
Inst. 6" Perf. Drain Pipe - 16842'  
Special Backfill - 120 C.Y.  
Tr. Exc. 130 C.Y.

Sta 474+26 to Sta 483+20  
Inst. 6" Perf. Drain Pipe - 894  
Special Backfill - 71 C.Y.  
Tr. Exc. 79 C.Y.

Sta 484+70 to Sta 498+60  
Inst. 24" Culv. Pipe - 326 (canal)  
Tr. Exc. 136 C.Y.

CULVERT B  
LENGTH=276  
ASSUMED SLOPE=0.5%

CULVERT A  
LENGTH=422  
ASSUMED SLOPE=0.33%

Sta. 457+98 to Sta. 475+7  
Inst. 6" Perf. Drain Pipe - 14  
Special Backfill - 135 C.Y.  
Tr. Exc. 150 C.Y.

Note:  
Const. Reinf. Conc. Bridge Panels  
Full Deck Width Shown Thus  
Drq. No. 2070

Note:  
For Median Berm Typical Section  
See Sht. 2

Sec. 11  
Const. Manhole With Grade  
Cover & Paved Apron  
Const. 2 Type G-2MA Inlets  
18" Conc. Culv. Pipe (in pl.)  
Extend - 24 Lt.  
4.4' Med.  
13' Ft.  
Tr. Exc. 15 C.Y.

6" Perf.  
For Quant. See Sht. 7  
R/W

2' R/W  
6" Perf. Pipe  
For Quant. See Sht. 7

Const. Guard Rail - 177 (Type 2A)  
Const. Median Berm  
With 2 Anchored Ends  
BR 8+00 POT.  
15' 483+95.67 POT.

Const. Guard Rail - 202 (Type 2A)  
With 2 Anchored Ends  
BR 6+50.38 POT.

FR 481+70.00 POT.  
BR 9+60.30 POT.  
BR 2+93.30 POT.

BR 10+81  
18" Conc. Culv. Pipe (in pl.)  
Extend - 20 Lt.  
4.4' Med.  
Const. Outlet Ditch  
2' Bottom, 2:1 Slopes  
Tr. Exc. 15 C.Y.  
Dt. Exc. 400 C.Y.

Sta 475+76 to Sta 483+25  
Inst. 6" Perf. Drain Pipe - 798'  
Special Backfill 58 C.Y.  
Tr. Exc. 65 C.Y.

Const. Guard Rail - 152 (Type 2A)  
300' Lt. (Type 2A)  
With 2 Anchored Ends  
Const. Type 2A Guard Rail - 204'  
With 2 Anchored Ends

Bridge No. 7695A  
Const. Boeckman Rd. U-Box Structure  
Roadway Width - 40'  
Dwg. Nos. See Sheet 1

Const. Drain Ditch  
For Quantities  
See Sheet 8A

DATE	
BY	
FINAL SURVEY	
TEMPLATE	
NO. 10	
NO. 10	

DATE	
BY	
ORIGINAL SURVEY	
NO. 10	
NO. 10	

BRIDGE DETAILS CHECKED: 2/2/74

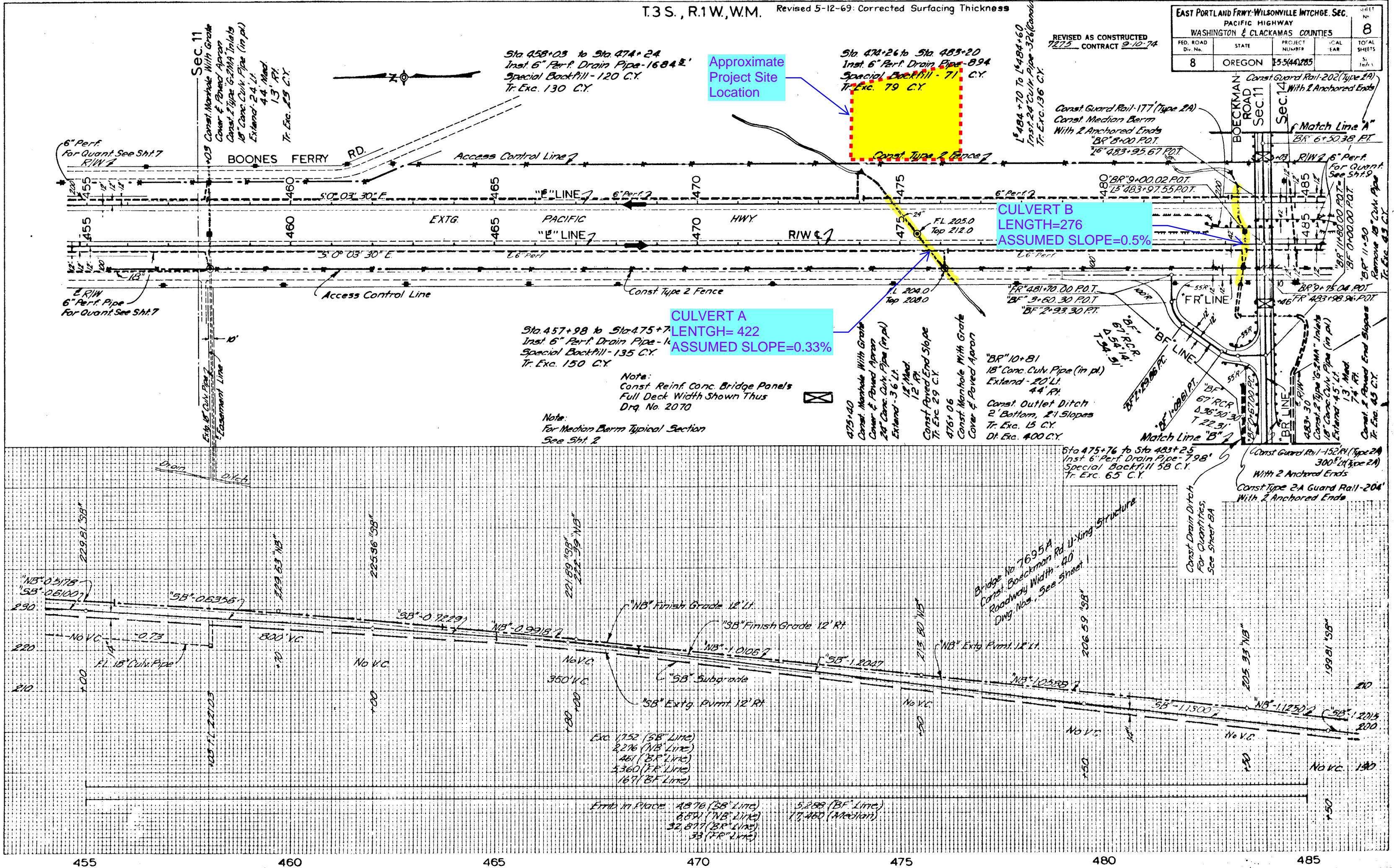

455 460 465 470 475 480 485



# Appendix G

Operations & Maintenance Manual\*

Page intentionally left blank for double-sided printing.





