

**DEVELOPMENT REVIEW BOARD MEETING**

**MONDAY, FEBRUARY 27, 2023**

**6:30 PM**

---

Public Hearing:

2. Resolution No. 412. Frog Pond Crossing Five-Year Temporary Use Permit. The applicant is requesting approval of a five (5) year Temporary Use Permit for one (1) 48-foot by 12-foot sales trailer and the eventual use of the Pulte Homes Model Home's garage as a sales office at the Frog Pond Crossing Subdivision.

Case Files:

DB22-0013 Five-Year Temporary Use Permit

**DEVELOPMENT REVIEW BOARD  
RESOLUTION NO. 412**

**A RESOLUTION ADOPTING FINDINGS AND CONDITIONS OF APPROVAL, APPROVING A FIVE-YEAR TEMPORARY USE PERMIT FOR ONE 48-FOOT BY 12-FOOT SALES TRAILER AND THE EVENTUAL USE OF THE PULTE HOMES MODEL HOME'S GARAGE AS A SALES OFFICE AT THE FROG POND CROSSING SUBDIVISION. THE SITE IS LOCATED AT 6737 AND 6725 SW WILDFLOWER STREET ON TAX LOT 300, SECTION 12D, TOWNSHIP 3 SOUTH, RANGE 1 WEST, WILLAMETTE MERIDIAN, CITY OF WILSONVILLE, CLACKAMAS COUNTY, OREGON. PULTE HOMES – APPLICANT/OWNER**

WHEREAS, an application, together with planning exhibits for the above-captioned development, has been submitted by Jim Sprott and Sandy Key, Pulte Homes – Applicant and Jim Sprott – Owners in accordance with the procedures set forth in Section 4.008 of the Wilsonville Code, and

WHEREAS, the subject site is located at 6737 and 6725 SW Wildflower Street on Tax Lot 300, Section 12D, Township 3 South, Range 1 West, Willamette Meridian, Clackamas County, Oregon, and

WHEREAS, the Planning Staff has prepared the staff report on the above-captioned subject dated February 16, 2023 and

WHEREAS, said planning exhibits and staff report were duly considered by the Development Review Board Panel B at a scheduled meeting conducted on February 27, 2023, at which time exhibits, together with findings and public testimony were entered into the public record, and

WHEREAS, the Development Review Board considered the subject and the recommendations contained in the staff report, and

WHEREAS, interested parties, if any, have had an opportunity to be heard on the subject.

NOW, THEREFORE, BE IT RESOLVED that the Development Review Board of the City of Wilsonville does hereby adopt the staff report dated February 16, 2023, attached hereto as Exhibit A1, with findings and recommendations contained therein, and authorizes the Planning Director to issue permits consistent with said recommendations for:

DB22-0013 Five (5) Year Temporary Use Permit

ADOPTED by the Development Review Board of the City of Wilsonville at a regular meeting thereof this 27<sup>th</sup> day of February, 2023 and filed with the Planning Administrative Assistant on \_\_\_\_\_. This resolution is final on the 15<sup>th</sup> calendar day after the postmarked date of the written notice of decision per *WC Sec 4.022(.09)* unless appealed per *WC Sec 4.022(.02)* or called up for review by the Council in accordance with *WC Sec 4.022(.03)*.

\_\_\_\_\_  
Rachelle Barrett, Chair - Panel B  
Wilsonville Development Review Board

Attest:

\_\_\_\_\_  
Shelley White, Planning Administrative Assistant



Exhibit A1  
Staff Report  
Wilsonville Planning Division  
Temporary Use Permit for Sales Trailer and Model Home Sales Office  
Development Review Board Panel 'B'  
Quasi-Judicial Public Hearing

---

---

<b>Hearing Date:</b>	February 27, 2023
<b>Date of Report:</b>	February 16, 2023
<b>Application No.:</b>	DB22-0013 TUP for a Sales Trailer and Model Home Sales Office at Frog Pond Crossing
<b>Request/Summary:</b>	The request before the Development Review Board includes the review of a Class 3 five-year Temporary Use Permit
<b>Location:</b>	6737 and 6725 SW Wildflower St. The property is specifically known as Tax Lot 300, Section 12D, Township 3 South, Range 1 West, Willamette Meridian, Clackamas County, Oregon.
<b>Owner/Applicant:</b>	Pulte Homes (Contacts Jim Sprott & Sandy Key)
<b>Comprehensive Plan Designation:</b>	Residential Neighborhood
<b>Zone Map Classification:</b>	Residential Neighborhood
<b>Staff Reviewers:</b>	Sarah Pearlman, Assistant Planner Georgia McAlister, Associate Planner
<b>Staff Recommendation:</b>	<u>Approve with conditions</u> the requested Five-Year Temporary Use Permit.

**Applicable Review Criteria:**

<b><u>Development Code:</u></b>	
Section 4.008	Application Procedures-In General
Section 4.009	Who May Initiate Application
Section 4.010	How to Apply
Section 4.011	How Applications are Processed
Section 4.014	Burden of Proof
Section 4.031	Authority of the Development Review Board
Subsection 4.035 (.04)	Site Development Permit Application
Subsection 4.035 (.05)	Complete Submittal Requirement
Section 4.110	Zones
Section 4.113	Standards Applying to Residential Development in All Zones
Section 4.118	Standards Applying to Planned Development Zones
Section 4.127	Residential Neighborhood (RN) Zone
Section 4.140	Planned Development Regulations
Section 4.154	On-site Pedestrian Access and Circulation
Section 4.155	Parking, Loading, and Bicycle Parking
Sections 4.156.01 through 4.156.11	Signs
Section 4.163	Temporary Structures and Uses
Section 4.175	Public Safety and Crime Prevention
Section 4.176	Landscaping, Screening, and Buffering
Section 4.199	Outdoor Lighting
Sections 4.300 through 4.320	Underground Utilities
Sections 4.400 through 4.440 as applicable	Site Design Review
<b><u>Comprehensive Plan and Sub-elements:</u></b>	
Frog Pond West Master Plan	

## Vicinity Map

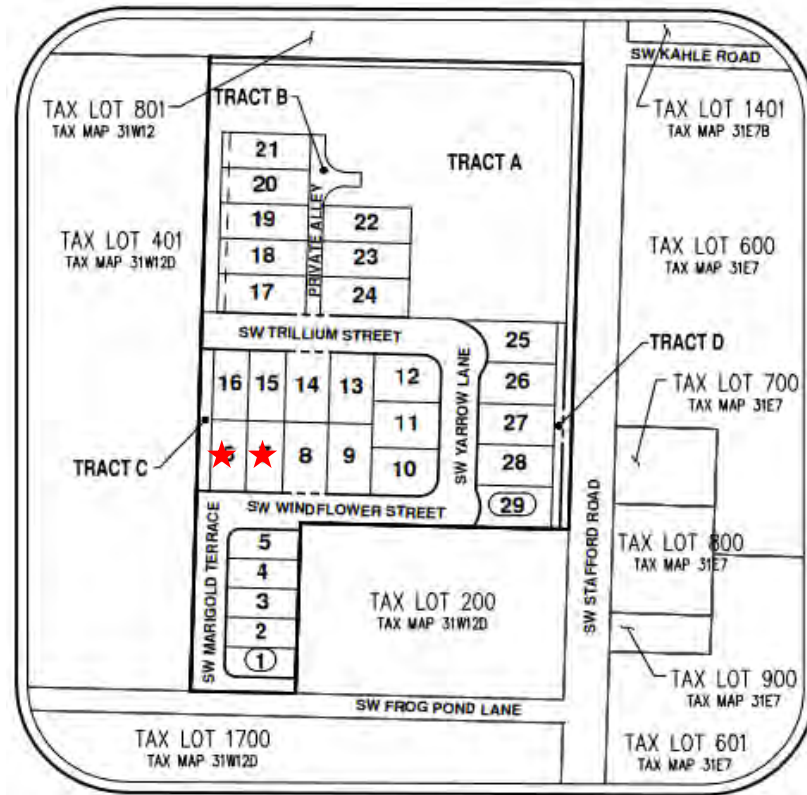

### Background/Summary:

Pulte Homes seeks a 5-year temporary use permit for a model home sales office and sales trailer to sell homes in the 29-lot Frog Pond Crossing subdivision. The applicant included plans for a sales office trailer on Lot 6 to sell homes in the subdivision until the completion of the model home on Lot 7. The applicant will then shift their sales operations to the garage of the model home. Pulte Homes will construct an asphalt parking lot with four parking spaces, including one ADA space, on Lot 6 for the sales trailer and the model home. Pulte Homes expects that within 5 years all of their homes in the subdivision will sell at which point the model home office on Lot 7 will be converted into a traditional garage.

### Public Comments and Responses:

No public comments were received during the comment period.

## Conclusion and Conditions of Approval:

Staff has reviewed the applicant's analysis of compliance with the applicable criteria. The Staff Report adopts the applicant's responses as Findings of Fact except as noted in the Findings. Based on the Findings of Fact and information included in this Staff Report, and information received from a duly advertised public hearing, staff recommends that the Development Review Board recommend approval to City Council or approve, as relevant, the proposed application (DB22-0013) with the following conditions:

### Planning Division Conditions:

Request: DB22-0013 Five-Year Temporary Use Permit

PD 1.	All construction, site development, and landscaping shall be carried out in substantial accord with the Development Review Board approved plans, drawings, sketches, and other documents. The Planning Division may approve minor alterations through the Class I Administrative Review process.
PD 2.	The access aisle for the required ADA parking shall be at least eight feet wide on the passenger side of the ADA space, consistent with the requirements of the Oregon Transportation Commission.
PD 3.	The applicant shall provide at least two bicycle parking spaces meeting the access, spacing, and other standards in Section 4.155.
PD 4.	The applicant shall obtain a sign permit pursuant to the standards of Section 4.156.09 for any proposed signs not exempted from sign permit requirements as noted in Section 4.156.05.
PD 5.	The sales trailer shall be removed upon the completion of the sales office in the model home. The applicant or their successors shall convert the sales office/model home to a for-sale single-family home within 5 years of the date of decision. The applicant or their successors shall remove the parking lot within 5 years of the date of decision.

### Engineering Division Conditions:

Request: DB22-0013 Preliminary Development Plan

PFD 1.	Public Works Plans and Public Improvements shall conform to the "Public Works Plan Submittal Requirements and Other Engineering Requirements" in Exhibit C1 and to specifics as found in the Frog Pond West Mater Plan (July 17, 2017).
PFD 2.	<b>Prior to Issuance of Building Permit:</b> Submit a site plan showing all utility connections and street improvements including pavement, curb, planter strip, street trees, sidewalk, and driveway approaches along the sites frontage on Windflower Street. Street improvements shall be constructed in accordance with the Public Works Standards.
PFD 3.	<b>Prior to Issuance of Building Permit:</b> A final stormwater report shall be submitted for review and approval. The stormwater report shall include information and calculations to demonstrate how the proposed development meets the treatment and

	flow control requirements. The stormwater report shall also include conveyance calculations to demonstrate that any downstream impacts can be mitigated.
<b>PFD 4.</b>	<b><u>Prior to the Issuance of the Building Permit:</u></b> Submit plan showing construction parking for contractors. All construction related parking must be within the Frog Pond Crossing subdivision boundaries.
<b>PFD 5.</b>	<b><u>Prior to the Issuance of the Building Permit:</u></b> All public improvements (water, sewer and storm) must be complete and ready for connection. Alternatively, the City may allow construction to commence prior to utilities being available if a temporary alternative solution is approved by the City.
<b>PFD 6.</b>	<b><u>Prior to Any Paving:</u></b> Downstream stormwater facilities must be constructed and planted. <b><u>Prior to Engineering Final:</u></b> The applicant must execute and record with the County a Stormwater Maintenance Agreement with the City.

**Master Exhibit List:**

The entry of the following exhibits into the public record by the Development Review Board confirms its consideration of the application as submitted. The exhibit list below includes exhibits for Planning Case File DB22-0013. The exhibit list below reflects the electronic record posted on the City’s website and retained as part of the City’s permanent electronic record. Any inconsistencies between printed or other electronic versions of the same Exhibits are inadvertent and the version on the City’s website and retained as part of the City’s permanent electronic record shall be controlling for all purposes.

Planning Staff Materials

- A1. Staff report and findings (this document)
- A2. Staff’s Presentation Slides for Public Hearing (to be presented at Public Hearing)

Materials from Applicant

- B1. Development Permit Application Forms
- B2. Narratives
- B3. Plan Sets

Development Review Team Correspondence

- C1. Engineering Division Conditions

**Procedural Statements and Background Information:**

1. The statutory 120-day time limit applies to this application. The applicant first submitted the application on December 14, 2022. On January 9, 2023, the application was deemed complete. The City must render a final decision for the request, including any appeals, by May 9, 2023.
2. Surrounding land uses are as follows:

Compass Direction	Zone:	Existing Use:
North	EFU	Rural Residential/Agriculture (Clackamas County)
East	EFU, RRFF5	Rural Residential/Agriculture (Clackamas County)
South	RN	Residential (Future Frog Pond Oaks)
West	RN	Residential (Under Construction, Frog Pond Ridge)

3. Previous City Planning Approvals:



DB21-0036 et seq Frog Pond Crossing Subdivision Annexation, Zone Map Amendment, Stage I Preliminary Plan, Stage II Final Plan, Site Design Review of Parks and Open Space, Tentative Subdivision Plat, Type C Tree Removal Plan, Waiver – Open Space Location, Waiver – Minimum Street Frontage

4. The applicant has complied with Sections 4.013-4.031 of the Wilsonville Code, said sections pertaining to review procedures and submittal requirements. The required public notices have been sent and all proper notification procedures have been satisfied.

## Findings:

NOTE: Pursuant to Section 4.014 the burden of proving that the necessary findings of fact can be made for approval of any land use or development application rests with the applicant in the case.

### General Information

#### Application Procedures-In General Section 4.008

**Criteria:** This section lists general application procedures applicable to a number of types of land use applications and also lists unique features of Wilsonville’s development review process.

**Response:** The application is being processed in accordance with the applicable general procedures of this Section.

#### Initiating Application Section 4.009

**Criterion:** “Except for a Specific Area Plan (SAP), applications involving specific sites may be filed only by the owner of the subject property, by a unit of government that is in the process of acquiring the property, or by an agent who has been authorized by the owner, in writing, to apply.”

**Response:** The application has been submitted on behalf of the property owner, Pulte Homes and is signed by Jim Sprott, an authorized representative.

#### Pre-Application Conference Subsection 4.010 (.02)

**Criteria:** This section lists the pre-application process.

**Response:** A Pre-application conference was not required.

#### Lien Payment before Approval Subsection 4.011 (.02) B.

**Criterion:** “City Council Resolution No. 796 precludes the approval of any development application without the prior payment of all applicable City liens for the subject property. Applicants shall be encouraged to contact the City Finance Department to verify that there are no outstanding liens. If the Planning Director is advised of outstanding liens while an application is under consideration, the Director shall advise the applicant that payments must be made current or the existence of liens will necessitate denial of the application.”

**Response:** No applicable liens exist for the subject property. The application can thus move forward.

## General Submission Requirements

Subsection 4.035 (.04) A.

**Criteria:** "An application for a Site Development Permit shall consist of the materials specified as follows, plus any other materials required by this Code." Listed 1. through 6. j.

**Response:** The applicant has provided all of the applicable general submission requirements contained in this subsection.

## Zoning-Generally

Section 4.110

**Criteria:** "The use of any building or premises or the construction of any development shall be in conformity with the regulations set forth in this Code for each Zoning District in which it is located, except as provided in Sections 4.189 through 4.192." "The General Regulations listed in Sections 4.150 through 4.199 shall apply to all zones unless the text indicates otherwise."

**Response:** This proposed temporary uses are in conformity with the applicable zoning district and general development regulations listed in Sections 4.150 through 4.199 have been applied in accordance with this Section.

### **Request: DB22-0013 Sales Trailer and Model Home Garage Sales Office**

As described in the Findings below, the applicable criteria for this request are met or will be met by Conditions of Approval.

## **Regulations in the Residential Neighborhood Zone**

### Permitted Uses in the Residential Neighborhood Zone

Subsection 4.127 (.02)

1. **Criteria:** This subsection lists the uses typically permitted in the Residential Neighborhood Zone, including single-family detached dwellings, row houses, and non-commercial parks, playgrounds, and recreational facilities.

**Response:** The Residential Neighborhood zone does not explicitly permit commercial development, such as sales offices. Section 4.163 allows for approval of temporary uses not otherwise allowed, which is the request of the applicant.

### Permitted Accessory Uses in the Residential Neighborhood Zone

Subsection 4.127 (.03)

2. **Criteria:** This subsection lists the permitted accessory uses in the Residential Zone among which is "temporary uses per Section 4.163".

**Response:** The temporary use for sales and display of new homes is accessory to the planned residential subdivision, subject to review pursuant to Section 4.163.

## Parking

### Functional Design of Parking Areas

Subsection 4.155 (.03) A.

3. **Criteria** This subsection establishes parking and loading or delivery areas design and access standards.

**Response:** The proposed parking area is accessible and has sufficient asphalt area for maneuvering into the parking stalls. The applicant does not propose any loading/delivery areas. Vehicle parking and pedestrian areas are separated.

### Parking Area Landscaping

Subsection 4.155 (.03) B. 1.-3.

4. **Criteria** This subsection establishes parking and loading or delivery area landscaping standards.

**Response:** The applicant proposes parking on a temporary asphalt park lot on Lot 6 and a compacted gravel driveway surface on Lot 7. The parking area is required to have 164 SF of landscaping. The applicant proposed 1,956 SF of landscaping on Lot 6.

### Safe and Convenient Access, ADA Requirement

Subsection 4.155 (.03) C.

5. **Criteria** This subsection establishes that off street parking shall be designed for safe and convenient access that meets ADA and ODOT standards

**Response:** The proposed design provides four spaces for the model home sales office, including one ADA space with an eight-foot access aisle on the passenger side of the space. Condition of Approval PD 2 insures ADA accessibility requirements, including an eight-foot-wide access aisle on the passenger side of the space, are met.

### Connectivity to adjacent Parking Areas and Efficient On-Site Circulation

Subsection 4.155 (.03) D.

6. **Criteria:** This subsection establishes that parking areas shall be designed to connect with parking areas on adjacent sites so as to eliminate the necessity for any mode of travel of utilizing the public street for multiple accesses or cross movements.

**Response:** No need exists to connect with parking on adjacent sites as the parking lot site and adjacent properties will be developed as single-family homes. The on-site parking is of a typical design on a flat site that will allow efficient on-site circulation.

### Parking Requirements

Subsection 4.155 (.03) G.

7. **Criteria:** This section establishes parking minimums.

**Response:** Per the requirements detailed in Table 5, office uses require 2.7 spaces per 1,000 sq. ft. of floor area. As such, the 576-square-foot sales trailer and 420-square-foot garage

sales office requires a total of two spaces each. A total of four parking spots are provided for the sales trailer and model home's sales office.

## Bicycle Parking Requirements

Subsection 4.155 (.04)

8. **Criteria** "Except as required by Subsections (A) through (D), below, the requirements of Section 4.155 shall apply within the Residential Neighborhood Zone."  
**Response:** Table 5 establishes a minimum bicycle parking requirement of two spaces for office use. There is no minimum requirement for single-family homes. The applicant has not indicated bicycle parking. Condition of Approval PD 3 ensures provision of the required bicycle parking.

## On-site Pedestrian Access and Circulation

### On-site Pedestrian Access and Circulation

Section 4.154 (.01) A.

9. **Criteria:** This section establishes standards for on-site pedestrian access and circulation.  
**Response:** The Frog Pond neighborhood was designed to be pedestrian-oriented. The existing and planned sidewalk network provides access to the model home sales office from the parking area. The applicant also plans to build a temporary pathway from the sales trailer parking lot on Lot 6 to the sales trailer and the model home on Lot 7 that provides safe, convenient pedestrian access.

### Continuous Pathway System

Section 4.154 (.01) B.

10. **Criteria:** This section establishes a pedestrian pathway system shall extend throughout the development site and connect to adjacent sidewalks, and to all future phases of development, as applicable.  
**Response:** The sidewalk will provide a continuous path between the parking area and sales office/model home. The temporary pathways also provides a continuous path between the sales trailer, parking lot, and model home.

### Safe, Direct and Convenient Pathways

Section 4.154 (.01) B

11. **Criteria:** This section establishes standards for on-site pedestrian access and circulation.  
**Response:** The asphalt parking area and sales trailer will be located on Lot 6, adjacent to the model home on Lot 7. Each lot in the Frog Pond Crossing subdivision has direct access to the comprehensive sidewalk network which Pulte Homes will utilize in addition to the construction of a temporary pathway from the parking lot on Lot 6 to the garage of the model home on Lot 7. The design of the parking area will allow customers to park on Lot 6 and safely take the sidewalk or the pathway to the model home on Lot 7. The sidewalk is at least 5' wide and ADA compliant. The temporary pathway will be made of asphalt and

will also be ADA compliant. The ADA parking space will be directly adjacent to the sidewalk and the pathway providing easy access.

### Vehicle /Pathway Separation

Section 4.154 (.01) B. 3.

12. **Criteria:** This section establishes standards for separation between vehicle circulation areas and pedestrian areas.

**Response:** The walkway is separated from vehicle circulation areas.

### Crosswalks

Section 4.154 (.01) B. 3.

13. **Criteria:** This section establishes standards for separation pathways crossing a parking area of driveway.

**Response:** The applicant does not propose new crosswalks across private parking areas or driveways.

### Pathway Width and Surface

Section 4.154 (.01) B.

14. **Criteria:** This section establishes standards for sidewalk materials and construction.

**Response:** The planned public sidewalks are one of the primary pathways and are concrete 5' sidewalks. The temporary pathway that the Applicant proposes between Lots 6 and 7 is at least 5' wide and is made of asphalt.

## Signs

### Exempt Signs

Subsection 4.156.05

15. **Criteria:** This subsection establishes signage that is exempt from permit requirements.

**Response:** No signage is proposed at this time. Signs listed under Section 4.156.05 are exempt from sign permit requirements, including some lawn signs and rigid signs. Condition of Approval PD 4 ensures that a sign permit is obtained pursuant to the standards of Section 4.156.09 for any proposed signs not meeting the requirements of this section.

## Temporary Structures and Uses

### Temporary Use Permits-Generally

Section 4.163

16. **Criteria:** "The Development Review Board, after hearing as set forth in Section 4.012, may permit the temporary use of a structure or premises in any zone for a purpose or use that does not conform to the regulations prescribed elsewhere in this Code for the zone in which it is located, provided that such use be of a temporary nature and does not involve the

erection of a substantial structure. A permit for such use may be granted in the form of a temporary and revocable permit, up to a five (5) year period, subject to a showing of good cause and such conditions as will safeguard the public health, safety, convenience and general welfare. Such permits may be renewable upon re-application to the Development Review Board, provided that the Board finds that the renewal is not likely to result in a permanent situation.”

**Response:** While the Residential Neighborhood zone permits some commercial development subject to approval of a conditional use permit, it does so only in locations master planned for the use. The Frog Pond West Master Plan and land use approvals for the subject properties do not allow commercial uses. Thus, the applicant requests a temporary use to allow a temporary commercial use on residential land. The model home sales office, sales trailer, and parking area will be located on lots planned to be developed into single family homes. The applicant is requesting a Temporary Use Permit for a sales trailer and model homes sales office up to five years to allow for a flexible time frame to construct and sell the homes in on the lots owned by Pulte Homes.

#### Temporary Use Permits-Temporary Use Does Not Involve Substantial Structures Subsection 4.163 (.01)

17. **Criteria:** This subsection establishes that no substantial structures can be built as a part of a Temporary Use Permit.

**Response:** While the proposed temporary use will utilize a single-family home structure planned for the subject lots, the applicant does not propose any substantial structures not planned for eventual approved single-family use.

#### Application Requirements, Restoration to Pre-TUP Conditions Subsection 4.163 (.02)

18. **Criteria:** This subsection establishes that no substantial structures can be built as a part of a Temporary Use Permit.

**Response:** The applicant has submitted the required information including a clear description of the planned use, a statement the duration is up to five years, and a site plan (see Exhibit B2). Condition of Approval PD 5 will ensure restoration of the site to pre-TUP conditions or to conditions as a single-family home subject to the approval of the Frog Pond Crossing subdivision.

#### Just Cause for Temporary Use Subsection 4.163 (.03)

19. **Criteria:** Factors and considerations for “good cause” include, but are not limited to:

- A. Availability of appropriately zoned land for the proposed use in the city.
- B. Availability of and need for the subject property for allowed uses.
- C. Market conditions, construction costs and other obstructions to the location of the use on appropriately zoned land.
- D. Due diligence of the applicant to site the use on appropriately zoned land,

E. Circumstances of the applicant bearing on the need for the temporary use permit.

**Response:**

**Availability of Appropriate Zoned Land:** While sufficient commercial land and tenant spaces exist in the City for real estate sales offices, it is typical to have an on-site sales office as part of a model home in a new large subdivision. Such uses have existed elsewhere in residential subdivisions.

**Availability of and need of property for allowed used:** Upon conclusion of the temporary use, the applicant will convert the subject lots to single-family homes for sale, which is the approved use.

**Market Conditions, etc.:** No market conditions are in play in terms of their being a lack of appropriately zoned land; the use is simply complementary to the allowed use during the sale of lots and homes in the adjacent subdivision.

**Due diligence to relocate use:** Not applicable. The use is only necessary during the sale of lots and homes in the adjacent subdivision.

**Circumstances of applicant:** The applicant owns the adjacent land on which they are developing single-family homes. They wish to increase their effectiveness of marketing and provide greater convenience for customers by providing an on-site sales office along with a model home.

**Other:** The proposed temporary use is a typical limited duration accessory use for new residential subdivisions.

## **Other Development Standards**

### Public Safety and Crime Prevention Subsection 4.175

20. **Criteria:** “All developments shall be designed to deter crime and ensure public safety.”  
**Response:** Staff finds no evidence and has not received any testimony that the proposal would lead to crime or negatively impact public safety.

### Outdoor Lighting Sections 4.199.20

21. **Criteria:** This section states that the outdoor lighting ordinance is applicable to “Installation of new exterior lighting systems in public facility, commercial, industrial and multi-family housing projects with common areas” and “Major additions or modifications (as defined in this Section) to existing exterior lighting systems in public facility, commercial, industrial and multi-family housing projects with common areas.” In addition the exempt luminaires and lighting systems are listed.  
**Response:** No additional outdoor lighting has been proposed. If the applicant wishes to add anything but exempt lighting, additional review by the City will be necessary.

### Underground Utility Installation Sections 4.300-4.320

22. **Criteria:** These sections list requirements regarding the underground installation of utilities.



**Response:** All new utilities associated with the temporary use must be installed underground. No indication of overhead utilities is shown in the submitted materials and there is no evidence that the proposal will cause conflict with underground utilities.



Planning Division
Development Permit Application

29799 SW Town Center Loop E, Wilsonville, OR 97070
Phone: 503.682.4960 Fax: 503.682.7025
Web: www.ci.wilsonville.or.us

Final action on development application or zone change is required within 120 days in accordance with provisions of ORS 227.175

A pre application conference is normally required prior to submittal of an application. Please visit the City's website for submittal requirements

Pre-Application Meeting Date: 9/27/2022

Incomplete applications will not be scheduled for public hearing until all of the required materials are submitted.

Applicant:

Name: Jim Sprott
Company: Pulte Homes
Mailing Address: 3535 Factoria Blvd SE #600
City, State, Zip: Bellevue, WA 98006
Phone: 425-216-3468 Fax:
E-mail: PNWPermitting@Pulte.com

Authorized Representative:

Name: Sandy Key
Company: Pulte Homes
Mailing Address: 3535 Factoria Blvd SE
City, State, Zip: Bellevue, WA 98006
Phone: Fax:
E-mail: PNWPermitting@Pulte.com

Property Owner:

Name: Jim Spratt
Company: Pulte Homes
Mailing Address: 3535 Factoria Blvd SE #600
City, State, Zip: Bellevue, WA 98006
Phone: 425-216-3468 Fax:
E-mail: jim.spratt@pultegroup.com

Property Owner's Signature:

[Handwritten Signature]
Printed Name: Jim Spratt Date: 12/14/22

Applicant's Signature: (If different from Property Owner)

[Blank Signature Line]
Printed Name: Date:

Site Location and Description:

Project Address if Available: 6737 SW Wildflower ST Wilsonville OR Suite/Unit
Project Location:
Tax Map #(s): Tax Lot #(s): County: [X] Washington [X] Clackamas

Request:

Place a temporary sales trailer on lot 6 to allow for sales for our community until the model home is completed

Project Type: Class I [ ] Class II [ ] Class III [X]

[ ] Residential [ ] Commercial [ ] Industrial [ ] Other:

Application Type(s):

- [ ] Annexation [ ] Appeal [ ] Comp Plan Map Amend [ ] Parks Plan Review
[ ] Final Plat [ ] Major Partition [ ] Minor Partition [ ] Request to Modify Conditions
[ ] Plan Amendment [ ] Planned Development [ ] Preliminary Plat [ ] Site Design Review
[ ] Request for Special Meeting [ ] Request for Time Extension [ ] Signs [ ] Stage II Final Plan
[ ] SROZ/SRIR Review [ ] Staff Interpretation [ ] Stage I Master Plan [ ] Variance
[ ] Type C Tree Removal Plan [ ] Tree Permit (B or C) [X] Temporary Use [ ] Other (describe)
[ ] Villebois SAP [ ] Villebois PDP [ ] Villebois FDP
[ ] Zone Map Amendment [ ] Waiver(s) [ ] Conditional Use



29799 SW Town Center Loop E, Wilsonville, OR 97070  
 Phone: 503.682.4960 Fax: 503.682.7025  
 Web: [www.ci.wilsonville.or.us](http://www.ci.wilsonville.or.us)

**Planning Division  
 Development Permit Application**

Final action on development application or zone change is required within 120 days in accordance with provisions of ORS 227.175

A pre application conference is normally required prior to submittal of an application. Please visit the City's website for submittal requirements

Pre-Application Meeting Date: 9/27/2022

**Incomplete applications will not be scheduled for public hearing until all of the required materials are submitted.**

**Applicant:**

Name: Jim Sprott  
 Company: Pulte Homes  
 Mailing Address: 3535 Factoria Blvd SE #600  
 City, State, Zip: Bellevue, WA 98006  
 Phone: 425-216-3468 Fax: \_\_\_\_\_  
 E-mail: PNWPermitting@Pulte.com

**Authorized Representative:**

Name: Sandy Key  
 Company: Pulte Homes  
 Mailing Address: 3535 Factoria Blvd SE  
 City, State, Zip: Bellevue, WA 98006  
 Phone: \_\_\_\_\_ Fax: \_\_\_\_\_  
 E-mail: PNWPermitting@Pulte.com

**Property Owner:**

Name: Jim Sprott  
 Company: Pulte Homes  
 Mailing Address: 3535 Factoria Blvd SE #600  
 City, State, Zip: Bellevue, WA 98006  
 Phone: 425-216-3468 Fax: \_\_\_\_\_  
 E-mail: \_\_\_\_\_

**Property Owner's Signature:**

*Jim Sprott*  
 Printed Name: Jim Sprott Date: 12/20/22

**Applicant's Signature:** (if different from Property Owner)

Printed Name: \_\_\_\_\_ Date: \_\_\_\_\_

**Site Location and Description:**

Project Address if Available: 6725 SW Wildflower ST Wilsonville OR Suite/Unit \_\_\_\_\_  
 Project Location: Northside  
 Tax Map #(s): \_\_\_\_\_ Tax Lot #(s): \_\_\_\_\_ County:  Washington  Clackamas

**Request:**

Open a temporary sales model in lot 7 SFR to allow for sales for our community

**Project Type: Class I**  **Class II**  **Class III**

Residential  Commercial  Industrial  Other: \_\_\_\_\_

**Application Type(s):**

- |  |   |   |   |
|--|---|---|---|
| <input type="checkbox"/> Annexation                  | <input type="checkbox"/> Appeal                     | <input type="checkbox"/> Comp Plan Map Amend      | <input type="checkbox"/> Parks Plan Review            |
| <input type="checkbox"/> Final Plat                  | <input type="checkbox"/> Major Partition            | <input type="checkbox"/> Minor Partition          | <input type="checkbox"/> Request to Modify Conditions |
| <input type="checkbox"/> Plan Amendment              | <input type="checkbox"/> Planned Development        | <input type="checkbox"/> Preliminary Plat         | <input type="checkbox"/> Site Design Review           |
| <input type="checkbox"/> Request for Special Meeting | <input type="checkbox"/> Request for Time Extension | <input type="checkbox"/> Signs                    | <input type="checkbox"/> Stage II Final Plan          |
| <input type="checkbox"/> SROZ/SRIR Review            | <input type="checkbox"/> Staff Interpretation       | <input type="checkbox"/> Stage I Master Plan      | <input type="checkbox"/> Variance                     |
| <input type="checkbox"/> Type C Tree Removal Plan    | <input type="checkbox"/> Tree Permit (B or C)       | <input checked="" type="checkbox"/> Temporary Use | <input type="checkbox"/> Other (describe)             |
| <input type="checkbox"/> Villebois SAP               | <input type="checkbox"/> Villebois PDP              | <input type="checkbox"/> Villebois FDP            |   |
| <input type="checkbox"/> Zone Map Amendment          | <input type="checkbox"/> Waiver(s)                  | <input type="checkbox"/> Conditional Use          |   |

Temporary use of a 48' x 12' sales trailer to allow for sales before the model home is constructed. Sales trailer will have a ramp and furnished inside. There will be an accessible restroom onsite.



Construct a single-family residence as model demonstration unit with a sales office located in the garage. The garage will temporarily be converted to a sales office that has temporary non structural walls, flooring, heating and a glass storefront in lieu of the garage door.



# FROG POND CROSSING LOT 6

SW WINDFLOWER ST, WILSONVILLE, OR  
CLACKAMAS COUNTY TAX LOT: TBD  
PLAN: 12'x48' SALES TRAILER  
DRB RESOLUTION NO. TBD  
PULTE HOMES  
ATTN: SANDY KEY (425) 216-3468

**GENERAL NOTES:**

1. PLOT PLAN SUBJECT TO APPROVAL BY ZONING/ BUILDING AUTHORITY PRIOR TO STAKEOUT.
2. GRADE 5% MIN. AWAY FROM BUILDING.
3. FLATWORK ELEVATION NOTED AT BUILDING WALL. SLOPE 2% MIN. AWAY FROM BUILDING
4. LOT LINES BASED ON UNRECORDED PLAT LINEWORK BY AKS ENGINEERING & FORESTRY, LLC.
5. ROOF DOWNSPOUTS SHALL CONNECT TO STORMWATER SERVICE LATERAL.
6. BUILDER RESPONSIBLE FOR SIDEWALK AND DRIVEWAY APPROACH CONSTRUCTION AT SW WINDFLOWER STREET FRONTAGE.

**CONCRETE WASHOUT NOTE:**

CONCRETE WASHOUT TO BE LOCATED ON LOT #.

**FOUNDATION NOTE:**

MAIN FINISH FLOOR ELEVATION BASED UPON FLOOR JOISTS ON TOP OF FOUNDATION WALL.

**STREET TREE:**

- CTP LIRIODENDRON TUPIPIFERA 'FASTIGIATA' COLUMNAR TULIP POPLAR 2" CAL. B&B  
CP PISTACIA CHINENSIS CHINESE PISTACHE 2" CAL. B&B

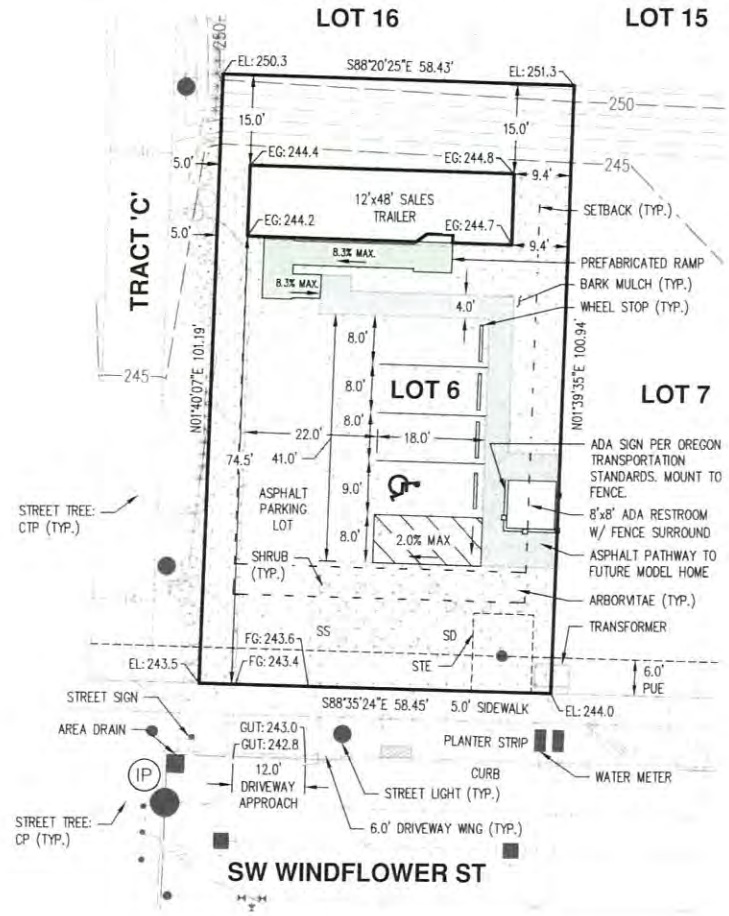
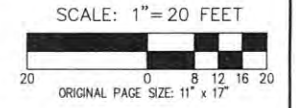
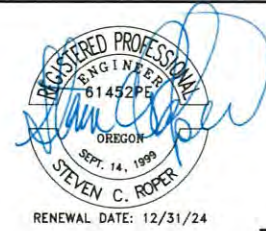

**ABBREVIATIONS:**

- EG EXISTING GRADE
- EL ELEVATION (EG AT PROPERTY CORNERS)
- FG FINISHED GRADE
- FFE FINISHED FLOOR ELEVATION
- GUT GUTTER ELEVATION
- PUE PUBLIC UTILITY EASEMENT
- SD STORM LATERAL
- SS SANITARY LATERAL
- STE PUBLIC STREET TREE EASEMENT

**EROSION CONTROL LEGEND:**

- (CE) 20.0'x20.0' GRAVEL CONSTRUCTION ENTRANCE - 3/4" CLEAN ROCK AT 8" DEPTH
- (IP) INLET PROTECTION

**WET WEATHER EROSION NOTES:**

1. IMMEDIATELY COVER EXPOSED SOIL DURING RAIN EVENTS WITH PLASTIC SHEETING, OR A 2-INCH LAYER OF MULCH, BARK, WOOD CHIPS, SAWDUST, OR STRAW TO MINIMIZE EROSION POTENTIAL.
2. EXPOSED SOILS SHALL BE SEEDED NO LATER THAN SEPTEMBER 1.

LOT COVERAGE	
LOT AREA	5,906 SF
BUILDING COVERAGE AREA	576 SF
BUILDING COVERAGE %	9.8%
IMPERVIOUS AREA	3,073 SF
LANDSCAPE COVERAGE	1,956 SF
LANDSCAPE COVERAGE %	33.1%

LAND USE DISTRICT AND SETBACKS	
LAND USE DISTRICT	RN (R-7)
FRONT YARD TO FRONT BUILDING SETBACK*	15'
FRONT YARD TO GARAGE SETBACK	20'
STREET SIDE YARD SETBACK	10'
SIDE YARD SETBACK	5'
REAR YARD SETBACK	15'

\* FRONT PORCHES MAY EXTEND 5.0' INTO SETBACK

DATE: 02/14/2023

<b>PLOT PLAN - LOT 6</b>	EXHIBIT
<b>FROG POND CROSSING</b>	<b>A</b>
AKS ENGINEERING & FORESTRY, LLC 12965 SW HERMAN RD, STE 100 TUALATIN, OR 97062 503.563.6151 WWW.AKS-ENG.COM	DRWN: KCL CHKD: DS AKS JOB: 5252-02

DWG: 5252-01 PROCESSING LOT 6 - SALES TRAILER | PLOT PLAN



In addition to your office solution, we can provide additional products and services that complete your space- creating a more productive, comfortable, and safe work environment.

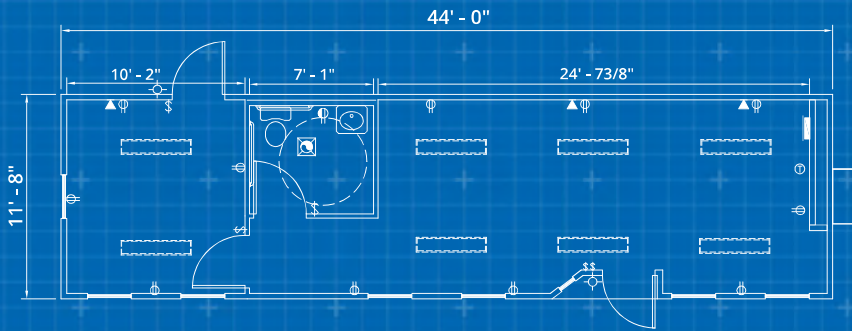

## CUSTOMIZATION

- Steps & Ramps
- Furniture & Appliances
- Technology
- Site Services
- Loss Protection

### Dimensions

48' Long (including hitch)  
 44' Box size  
 12' Wide  
 8' Ceiling height

### Exterior Finish

Aluminum or wood siding  
 I-Beam Frame  
 Standard drip rail gutters

### Interior Finish

Vinyl covered gypsum walls  
 Commercial carpeting throughout  
 Gypsum or T-grid suspended ceiling

### Electric

Fluorescent ceiling lights  
 Single phase electric and breaker panel

### Heating/Cooling

Central HVAC and duct heating

### Windows/Doors

Large glass windows  
 French door

### Other

Large display/reception area  
 Private office(s)  
 Handicapped accessible restroom  
 Coffee bar

*\* Photos are representational; actual products vary. Additional floor plans and specifications may vary from those shown and are subject to in-stock availability*





# FROG POND CROSSING

## LOT 7

SW WINDFLOWER ST, WILSONVILLE, OR  
 CLACKAMAS COUNTY TAX LOT: TBD  
 PLAN: LYNWOOD C

DRB RESOLUTION NO. DB21-0036 - DB21-0044  
 PULTE HOMES  
 ATTN: SANDY KEY (425) 216-3468

### GENERAL NOTES:

1. PLOT PLAN SUBJECT TO APPROVAL BY ZONING/BUILDING AUTHORITY PRIOR TO STAKEOUT.
2. GRADE 5% MIN. AWAY FROM BUILDING.
3. FLATWORK ELEVATION NOTED AT BUILDING WALL. SLOPE 2% MIN. AWAY FROM BUILDING.
4. LOT LINES BASED ON UNRECORDED PLAT LINWORK BY AKS ENGINEERING & FORESTRY, LLC.
5. ROOF DOWNSPOUTS SHALL CONNECT TO STORMWATER FILTRATION PLANTER.
6. BUILDER RESPONSIBLE FOR SIDEWALK AND DRIVEWAY APPROACH CONSTRUCTION AT SW WINDFLOWER STREET FRONTAGE.

### CONCRETE WASHOUT NOTE:

CONCRETE WASHOUT TO BE LOCATED ON LOT 2.

### FOUNDATION NOTE:

MAIN FINISH FLOOR ELEVATION BASED UPON FLOOR JOISTS ON TOP OF FOUNDATION WALL.

### STREET TREE:

CP PISTACIA CHINENSIS CHINESE PISTACHE 2" CAL. B&B

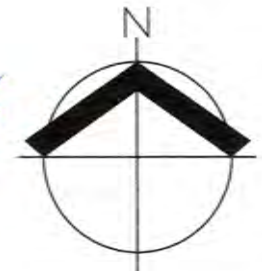

SCALE: 1" = 20 FEET

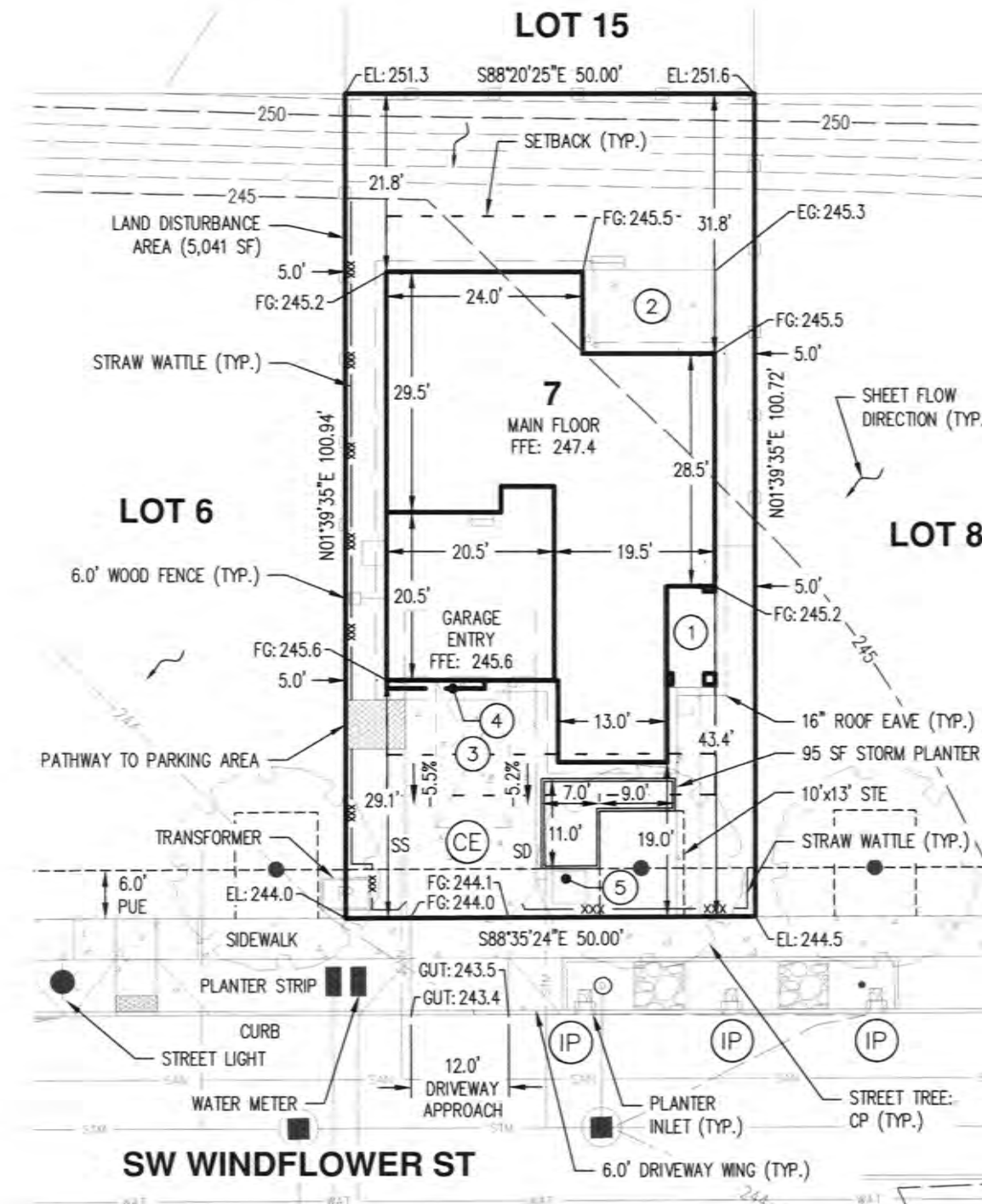
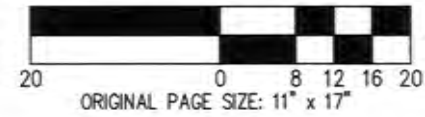

### KEY NOTES:

1. FRONT PORCH FFE: 246.9
2. CONCRETE PATIO FFE: 246.9
3. 9.0'x18.0' PARKING SPOT
4. 1.0' UPPER FLOOR CANTILEVER
5. CONSTRUCTION GARBAGE RECEPTACLE

### ABBREVIATIONS:

- EG EXISTING GRADE
- EL ELEVATION (EG AT PROPERTY CORNERS)
- FG FINISHED GRADE
- FFE FINISHED FLOOR ELEVATION
- GUT GUTTER ELEVATION
- PUE PUBLIC UTILITY EASEMENT
- SD STORM LATERAL
- SS SANITARY LATERAL
- STE PUBLIC STREET TREE EASEMENT

### EROSION CONTROL LEGEND:

- (CE) 20.0'x20.0' GRAVEL CONSTRUCTION ENTRANCE - 3/4" CLEAN ROCK AT 8" DEPTH
- (IP) INLET PROTECTION

### WET WEATHER EROSION NOTES:

1. IMMEDIATELY COVER EXPOSED SOIL DURING RAIN EVENTS WITH PLASTIC SHEETING, OR A 2-INCH LAYER OF MULCH, BARK, WOOD CHIPS, SAWDUST, OR STRAW TO MINIMIZE EROSION POTENTIAL.
2. EXPOSED SOILS SHALL BE SEEDED NO LATER THAN SEPTEMBER 1.

LOT COVERAGE	
LOT AREA	5,041 SF
BUILDING COVERAGE AREA	1,985 SF
BUILDING COVERAGE %	39.4%
IMPERVIOUS AREA	2,529 SF

LAND USE DISTRICT AND SETBACKS	
LAND USE DISTRICT	RN (R-7)
FRONT YARD TO FRONT BUILDING SETBACK*	15'
FRONT YARD TO GARAGE SETBACK	20'
STREET SIDE YARD SETBACK	10'
SIDE YARD SETBACK	5'
REAR YARD SETBACK	15'

\* FRONT PORCHES MAY EXTEND 5.0' INTO SETBACK

DATE: 12/13/2022

PLOT PLAN - LOT 7		EXHIBIT
FROG POND CROSSING		A
AKS ENGINEERING & FORESTRY, LLC 12965 SW HERMAN RD, STE 100 TUALATIN, OR 97062 503.563.6151 WWW.AKS-ENG.COM		DRWN: JF CHKD: SCR AKS JOB: 5252-02





# Pacific Northwest Division

3535 Factoria Blvd SE, Suite 600  
 Bellevue, Washington 98006  
 (425) 641-1787

# Frog Pond Crossing - 4000 Series

READ ALL SHEETS PRIOR TO CONSTRUCTION, ALL CONSTRUCTION MUST ADHERE TO CITY APPROVED CONSTRUCTION DOCUMENTS

## BUILDING AREAS

**ELEVATION B**

OPT NOT SELECTED

**ELEVATION C**

SPACE	AREA (SF)
A - Livable (First Floor)	1448
B - Livable (Second Floor)	1913
----- SUBTOTAL LIVABLE	3360
----- SUBTOTAL MAXIMUM LIVABLE	3360
C - Covered Patio	160
D - Garage	45.3
E - Porch	72
----- TOTAL STANDARD UNDER ROOF	4046
----- TOTAL STANDARD FOOTPRINT	2133
----- TOTAL MAXIMUM UNDER ROOF	4044
----- TOTAL MAXIMUM FOOTPRINT	2131

**ELEVATION D**

OPT NOT SELECTED

## ABBREVIATIONS

ABV	ABOVE	FX	FIXED (PICTURE) WINDOW	PL	PLATE
ADJ	ADJUSTABLE / ADJACENT	FR	FRENCH	PLB	PLUMBING
A/C	AIR CONDITIONING	FLR	FLOOR	PLY	PLYWOOD
ADD'L	ADDITIONAL	FD	FLOOR DRAIN	PVC	POLYVINYL CHLORIDE
AFF	ABOVE FINISHED FLOOR	FLUOR	FLUORESCENT	PRV	PRESSURE RELIEF VALVE
ALT	ALTERNATE	FT	FOOT/FEET	PSF	POUNDS PER SQUARE FOOT
ANCH	ANCHOR BOLT	FTG	FOOTING	PSI	POUNDS PER SQUARE INCH
ARCH	ARCHITECTURAL	FND	FOUNDATION	P	PROPERTY LINE
AUTO	AUTOMATIC	FURR	FURRED (ING)	PR	PAIR
BLW	BELOW	FOS	FACE OF STUD	RAD	RADIUS
BM	BEAM	FG	FINISH GRADE	REC	RECEPTACLE
BRC	BEARING	FJ	FLOOR JOIST	REF	REFRIGERATOR
BTWN	BETWEEN	GA	GAUGE	REIN	REINFORCE (D) (ING)
BLK	BLOCK	GALV	GALVANIZED	R/A	RETURN AIR
BLKG	BLOCKING	GC	GENERAL CONTRACTOR	RM	ROOM
BTM	BOTTOM	GL	GLASS, GLAZING	RO	ROUGH OPENING
B/O	BOTTOM OF	GL BLK	GLASS BLOCK	R&S	ROD AND SHELF
BLDG	BUILDING	GYP BD	GYPSPUM BOARD	SCH	SCHEDULE
CAB	CABINET	GYP	GYPSPUM	SECT	SECTION
CFH	CUBIC FEET PER HOUR	GI	GALVANIZED IRON	SGD	SLIDING GLASS DOOR
C	CENTER LINE	HDW	HARDWARE	SH	SINGLE HUNG WINDOW
CLG	CEILING	HDR	HEADER	SHWR	SHOWER
CLG HT	CEILING HEIGHT	HVAC	HEATING/VENTING/ AIR CONDITIONING	SHT	SHEET
CTR	CENTER	HC	HOLLOW CORE / HANDICAP	SIM	SIMILAR
CLR	CLEAR (ANCE)	h	HIGH	SOF	SOFFIT
CLO	CLOSET	HT	HEIGHT	SC	SOLID CORE
CM	CULTURED MARBLE	HOR	HORIZONTAL	SPEC	SPECIFICATION
COL	COLUMN	HR	HORIZONTAL	SQ	SQUARE
COMB	COMBUSTION	HB	HOSE BIBB	STD	STANDARD
CONC	CONCRETE	HR	HOUR	STL	STEEL
CPT	CARPET	IN	INCH	STOR	STORAGE
CMU	CONCRETE MASONRY UNIT	INCL	INCLUDE (ED) (ING)	STORCT	STRUCTURAL
CONST	CONSTRUCTION	INSUL	INSULATE / INSULATION	SYS	SYSTEM
CONT	CONTINUOUS OR CONTINUE	INT	INTERIOR	SHTG	SHEATHING
CJ	CONTROL JOINT	KIT	KITCHEN	SMB	STRUCTURE WIRE BOX
CT	CIRCLE TOP / FULL ARCH TOP WINDOW	LAV	LAVATORY	TV	TELEVISION
d	DEEP / DEPTH	LDY	LAUNDRY	TEMP	TEMPERED / TEMPERATURE
DTL	DETAIL	LIN	LINEN	THK	THICK (NESS)
DIAG	DIAGONAL	LVR	LOUVER	THRES	THRESHOLD
DIA	DIAMETER	LTG	LIGHTING	T&G	TONGUE AND GROOVE
DIM	DIMENSION	MFR	MANUFACTURE (R)	T/O	TOP OF
DISP	DISPOSAL	MAS	MASONRY	TYP	TYPICAL
DIV	DIVISION	MO	MASONRY OPENING	UNO	UNLESS NOTED OTHERWISE
DR	DOOR	MTL	MATERIAL / METAL	VER	VERTICAL
DWG	DRAWING	MAX	MAXIMUM	VEST	VESTIBULE
DN	DOWN	MECH	MECHANIC (AL)	VIF	VERIFY IN FIELD
ELECT	ELECTRIC (AL)	MC	MEDICINE CABINET	VP	VAPOR PROOF
ELEV	ELEVATION	MIN	MINIMUM	VTR	VENT THROUGH ROOF
EA	EACH	MISC	MISCELLANEOUS	WC	WATER CLOSET
EB	EYE BROW / EYEBALL	NTS	NOT TO SCALE	WP	WATER PROOF (ING)
EJ	EXPANSION JOINT	o/c	ON CENTER	w	WIDE / WIDTH
EQ	EQUAL	OBS	OBSCURE	w/	WITH
EQUIP	EQUIPMENT	OPT	OPTION (AL)	w/o	WITHOUT
EXH	EXHAUST	OH	OVERHEAD	WD	WOOD
EXIST	EXISTING	OPNG	OPENING	WH	WATER HEATER
EXT	EXTERIOR	PNL	PANEL	XO / YOX	HORIZONTAL SLIDING WINDOW
FAU	FORCED AIR UNIT	PBD	PARTICLE BOARD	X	OPERABLE, O = FIXED
FIN	FINISH	PH	TELEPHONE		

## MUNICIPALITY

JURISDICTION: CITY OF WILSONVILLE

## DESIGN CRITERIA

SINGLE FAMILY DETACHED WITH ATTACHED PRIVATE GARAGE  
 FIRE SPRINKLERS REQUIRED: YES

## ARCHITECTURAL SYMBOLS

DETAIL REFERENCE:		DETAIL NUMBER SHEET NUMBER
BUILDING SECTION REFERENCE:		SECTION SHEET NUMBER
REVISION REFERENCE:		REVISION NUMBER
ELEVATION THICKNESS REFERENCE:		REFER TO EXTERIOR AND INTERIOR ELEV.
INTERIOR ELEVATION REFERENCE:		DETAIL NUMBER / SHEET
INTERIOR ELEVATION REFERENCE:		ORIENTATION SHEET NUMBER
OPTION KEY NOTE REFERENCE:		OPTION NUMBER

## BUILDING CODES

**GOVERNING BUILDING CODE**  
 ALL WORK SHALL BE IN ACCORDANCE WITH THE FOLLOWING MUNICIPALITY ADOPTED CODES AND ORDINANCES.

INTERNATIONAL RESIDENTIAL / BUILDING CODE	2018
OREGON RESIDENTIAL SPECIALTY CODE	2021
UNIFORM PLUMBING CODE	2018

## CONSULTANTS

STRUCTURAL ENGINEER:	Mulhern & Kulp Structural Engineering 20 S. Maple Street Amber, PA 19002 Tel: (215) 646-8001 Contact: Nick Martignetti
MECHANICAL CONSULTANT:	N/A
ENERGY CONSULTANT:	N/A
PLUMBING CONSULTANT:	N/A
GEOTECHNICAL CONSULTANT:	N/A

## SHEET INDEX

REV #	DATE	DESCRIPTION
1		
2		
3		
4		
5		
6		
7		
8		
9		
10		
11		
12		
13		
14		
15		
16		
17		
18		
19		
20		
21		
22		
23		
24		
25		
26		
27		
28		
29		
30		
31		
32		
33		
34		
35		
36		
37		
38		
39		
40		
41		
42		
43		
44		
45		
46		
47		
48		
49		
50		
51		
52		
53		
54		
55		
56		
57		
58		
59		
60		
61		
62		
63		
64		
65		
66		
67		
68		
69		
70		
71		
72		
73		
74		
75		
76		
77		
78		
79		
80		
81		
82		
83		
84		
85		
86		
87		
88		
89		
90		
91		
92		
93		
94		
95		
96		
97		
98		
99		
100		

**LOT 7 - OPTION LIST**  
 ELEVATION C  
 CHEF KITCHEN  
 EXECUTIVE ISLAND  
 PRE-PLUMB LAUNDRY  
 GARAGE SERVICE DOOR  
 BEDROOM AND BATH  
 COVERED PATIO  
 INTERIOR FIREPLACE 2  
 RAIL LOCATION 1  
 FREESTANDING TUB  
 TRAY CEILING -  
 OWNER'S SUITE  
 SINK - BATH 2

Seattle Division  
 3535 Factoria Blvd SE  
 Bellevue, Washington 98006

**Pulte HOMES**

PRODUCTION MANAGER  
 Josh DeVoll  
 CURRENT RELEASE DATE: /-/-  
 REV # DATE DESCRIPTION

PROJECT TYPE  
 Single Family

COMMUNITY NAME  
 Frog Pond Crossing  
 4000 Series

LAWSON COMMUNITY ID  
 8305

GARAGE HANDING  
 Left

SPECIFICATION LEVEL  
 Pulte

PLAN NAME  
 Lynwood

NO PLAN NUMBER  
 2374.401

LAWSON PLAN ID  
 40333

LEGACY PLAN NUMBER / NAME  
 4033-3

SHEET  
 G0.00

NOTE: SCALES NOTED ON DRAWINGS RELATE TO FULL SIZE PLOTS ON 22x34 SHEETS - 11x17 SHEETS REPRESENT 1/2 SCALE PLOTS



# PCR'S / REDLINE LOG

PLAN	SHEETS	DATE	PCR	DELTA	DESCRIPTION	INITIALS
4033-3	-	-	-	1	INTERNAL REVIEW	EC 10.21.2022
				A1.13/ A1.23/ E1.13/E 1.23	ADDED SOUND DAMPENING OPTIONS	

# GENERAL ARCHITECTURAL NOTES and SPECIFICATIONS

## DIVISION 1: GENERAL REQUIREMENTS

1. THE UNDERSIGNED, PULTE HOMES CORPORATION AND ENGINEER DO NOT REPRESENT THAT THESE PLANS OR SPECIFICATIONS IN CONNECTION THEREWITH ARE SUITABLE, WHETHER OR NOT MODIFIED, FOR ANY SITE OTHER THAN THE ONE FOR WHICH THEY WERE SPECIFICALLY PREPARED. PULTE HOMES CORPORATION DISCLAIMS RESPONSIBILITY FOR THESE PLANS OR SPECIFICATIONS IF THEY ARE USED IN WHOLE OR IN PART AT ANY OTHER SITE. CONTRACTOR SHALL VERIFY THAT ONLY CITY APPROVED CONSTRUCTION DOCUMENTS ARE UTILIZED FOR CONSTRUCTION PURPOSES.

2. THE ARCHITECTURAL CONSTRUCTION DRAWINGS AND GENERAL NOTES DELINEATE AND DESCRIBE ONLY LOCATIONS, DIMENSIONS, TYPES OF MATERIALS AND GENERAL METHODS OF ASSEMBLING OR FASTENING. THEY ARE NOT INTENDED TO SPECIFY PARTICULAR PRODUCTS OR OTHER METHODS OF APPLICATION, EXCEPT WHERE SPECIFICALLY NOTED. PULTE HOMES ASSUMES NO RESPONSIBILITY FOR THE SELECTION, FABRICATION OR INSTALLATION OF ANY SPECIFIC MATERIAL, PRODUCT OR METHOD. FIELD OBSERVATION VISITS BY PULTE HOMES REPRESENTATIVE SHALL NOT BE CONSTRUED AS INSPECTION OR APPROVAL OF CONSTRUCTION.

3. CONTRACTOR SHALL VERIFY AND BE RESPONSIBLE FOR ALL DIMENSIONS AND CONDITIONS ON THE JOB. PULTE HOMES OFFICE MUST BE NOTIFIED IN WRITING OF ANY VARIATIONS AND DISCREPANCIES FOR RESOLUTION PRIOR TO CONSTRUCTION. THESE DRAWINGS ARE NOT FINAL UNTIL SIGNED BY THE STRUCTURAL ENGINEER OF RECORD AND APPROVED BY THE APPROPRIATE GOVERNING BUILDING DEPARTMENT. UNDER NO CIRCUMSTANCES SHALL DRAWINGS BE USED WHICH ARE NOT SIGNED BY THE ENGINEER OR STAMPED "PRELIMINARY, NOT FOR CONSTRUCTION" OR NOT APPROVED BY THE APPROPRIATE GOVERNING BUILDING DEPARTMENT. USE OF SUCH DRAWINGS WILL PLACE FULL AND COMPLETE LEGAL LIABILITY FOR THE ENTIRE JOB ON THE CONTRACTOR SOLELY. IT IS THE RESPONSIBILITY OF THE BUILDER/CONTRACTOR TO VERIFY THAT ALL TRADES ARE SUPPLIED w/ PROPERLY APPROVED CONSTRUCTION DOCUMENTS FOR ALL CONSTRUCTION RELATED PURPOSES. TYPICAL DETAILS MAY NOT NECESSARILY BE CUT ON THE PLANS, BUT APPLY TO THE PROJECT AS A WHOLE, UNLESS NOTED OTHERWISE.

4. ESTABLISH AND VERIFY ALL OPENINGS AND INSERTS FOR ARCHITECTURAL, MECHANICAL, PLUMBING AND ELECTRICAL WITH APPROPRIATE TRADES, DRAWINGS AND SUBCONTRACTORS PRIOR TO CONSTRUCTION.

### 5. OPTIONS AND SUBSTITUTIONS:

OPTIONS ARE FOR THE CONTRACTOR'S CONVENIENCE. HE SHALL BE RESPONSIBLE FOR ALL CHANGES NECESSARY. IF HE CHOOSES AN OPTION, IT IS THEN THE CONTRACTOR'S RESPONSIBILITY TO COORDINATE ALL DETAILS AND MANUFACTURER SPECIFICATIONS, NOTES AND DETAILS GENERATED FOR THE USE OF OPTIONS SHALL TAKE PRECEDENCE OVER THE GENERAL NOTES, TYPICAL DETAILS, AND SPECIFICATIONS. WHERE NO DETAILING IS SHOWN OR INDICATED, CONSTRUCTION SHALL CONFORM TO SIMILAR WORK ON THE PROJECT SITE. PRIOR TO CONSTRUCTION, THE CONTRACTOR SHALL VERIFY AND BE RESPONSIBLE FOR FIT CORRECTNESS, AND COORDINATION TO ALL DIMENSIONS. ANY ENGINEERING DESIGN PROVIDED BY OTHERS FOR INCLUSION TO THIS PROJECT AND SUBMITTED FOR REVIEW SHALL BEAR THE SEAL AND SIGNATURE OF AN ENGINEER REGISTERED IN THE STATE FOR WHICH THIS PROJECT IS LOCATED.

SUBSTITUTIONS, AS MAY BE APPROVED BY THE BUILDING OFFICIAL, TO MATERIALS, ASSEMBLIES, AND / OR COMPONENTS SHALL MEET THE DESIGN AND PERFORMANCE REQUIREMENTS FOR THE CONSTRUCTION AS ORIGINALLY INTENDED IN THESE SPECIFICATIONS. THE CONTRACTOR SHALL SUBMIT SHOP DRAWINGS AND SPECIFICATIONS FOR APPROVAL PRIOR TO CONSTRUCTION.

6. ALL PRODUCTS LISTED BY ICBO/NER NUMBER(S) SHALL BE INSTALLED PER THE REPORT AND MANUFACTURER'S WRITTEN INSTRUCTIONS. PRODUCT SUBSTITUTION(S) FOR PRODUCT(S) LISTED SHALL ALSO HAVE ICC APPROVED EVALUATION REPORT(S) OR BE APPROVED AND LISTED BY OTHER NATIONALLY RECOGNIZED TESTING AGENCIES.

7. CONTRACTOR WILL WORK WITHIN THE GUIDELINES AND STANDARDS SET BY OSHA.

### 8. TEMPORARY TOILETS:

PROVIDE PROPER AND ADEQUATE TOILET FACILITIES FOR THE USE OF ALL PERSONNEL EMPLOYED ON THE PROJECT, AS REQUIRED BY BUILDING AND SANITARY CODES. ENFORCE THEIR USE BY ALL PERSONNEL ON THE PROJECT.

### 9. TRASH REMOVAL:

PROVIDE ONSITE DUMPSTER OR APPROVED TRASH CONTAINER. ALL CONSTRUCTION TRASH AND DEBRIS SHALL BE CLEANED FROM THE SITE AND DISPOSED OF AT THE END OF EACH WORKING DAY.

### 10. TEMPORARY UTILITIES:

TEMPORARY LIGHT AND POWER SUPPLY FOR ALL CONSTRUCTION SHALL BE MADE AVAILABLE AT THE PROJECT SITE. PROVIDE ALL TEMPORARY WIRING AND CONNECTION TO EXISTING POWER SUPPLY. TEMPORARY WATER SUPPLY FOR CONSTRUCTION PURPOSES SHALL ALSO BE MADE AVAILABLE AT THE PROJECT SITE. COST OF TEMPORARY POWER AND WATER CONSUMED DURING THE COURSE OF CONSTRUCTION SHALL BE PAID BY THE CONTRACTOR. ANY SUBCONTRACTOR MAY EXTEND THESE SERVICES AT HIS EXPENSE TO SUIT HIS CONVENIENCE.

### 11. TEMPORARY SUPPORT:

THE CONTRACTOR SHALL PROVIDE ALL TEMPORARY BRACING, SHORING, CLYING, SUPPORT, OR OTHER MEANS AS REQUIRED TO AVOID EXCESSIVE STRESSES AND TO HOLD STRUCTURAL ELEMENTS IN PLACE DURING CONSTRUCTION AND / OR ERECTION. ESTABLISH AND VERIFY ALL OPENINGS AND INSERTS FOR MECHANICAL, ELECTRICAL, AND PLUMBING WITH THE APPROPRIATE TRADES, DRAWINGS, SHOP DRAWINGS, AND SUBCONTRACTORS PRIOR TO CONSTRUCTION.

## 2021 OREGON ENERGY EFFICIENCY SPECIALTY CODE

TABLE N1101.1(1) PRESCRIPTIVE ENVELOPE REQUIREMENTS<sup>a</sup>

BUILDING COMPONENT	STANDARD BASE CASE		LOG HOMES ONLY	
	Required Performance	Equiv. Value <sup>b</sup>	Required Performance	Equiv. Value <sup>b</sup>
Wall insulation—above grade	U-0.059 <sup>f</sup>	R-21 Intermediate <sup>c</sup>	Note d	Note d
Wall insulation—below grade <sup>e</sup>	C-0.063	R-15 c.i. / R-21	C-0.063	R-15/R-21
Flat ceilings <sup>f</sup>	U-0.021	R-49	U-0.020	R-49 A <sup>g</sup>
Vaulted ceilings <sup>g</sup>	U-0.033	R-30 Rather or R-30A <sup>h</sup> Scissor Truss	U-0.027	R-36A <sup>g</sup>
Underfloors	U-0.033	R-30	U-0.033	R-30
Slab-edge perimeter <sup>h</sup>	F-0.520	R-15	F-0.520	R-15
Heated slab interior <sup>i</sup>	n/a	R-10	n/a	R-10
Windows <sup>j</sup>	U-0.27	U-0.27	U-0.27	U-0.27
Skyights	U-0.50	U-0.50	U-0.50	U-0.50
Exterior doors <sup>k</sup>	U-0.20	U-0.20	U-0.54	U-0.54
Exterior doors with > 2.5 ft <sup>2</sup> glazing <sup>l</sup>	U-0.40	U-0.40	U-0.40	U-0.40

TABLE N1101.1(2) ADDITIONAL MEASURES

1	<b>HIGH EFFICIENCY HVAC SYSTEM<sup>a</sup></b> a. Gas-fired furnace or boiler AFUE 94%, or b. Air source heat pump HSPF 10.0/14.0 SEER cooling, or c. Ground source heat pump COP 3.5 or Energy Star rated
2	<b>HIGH EFFICIENCY WATER HEATING SYSTEM</b> a. Natural gas/propane water heater with minimum UEF 0.69, or b. Electric heat pump water heater with minimum 2.0 COP, or c. Natural gas/propane tankless/instantaneous heater with minimum 0.80 UEF and Drain Water Heat Recovery Unit installed on minimum of one shower/tub/shower
3	<b>WALL INSULATION UPGRADE</b> Exterior walls—U-0.045/R-21 conventional framing with R-5.0 continuous insulation
4	<b>ADVANCED ENVELOPE</b> Windows—U-0.21 (Area-weighted average), and Flat ceiling <sup>g</sup> —U-0.017/R-80, and Framed floors—U-0.026/R-38 or slab edge insulation to F-0.48 or less (R-10 for 48", R-15 for 36" or R-5 fully insulated slab)
5	<b>DUCTLESS HEAT PUMP</b> For dwelling units with all-electric heat provide: Ductless heat pump of minimum HSPF 10 in primary zone replaces zonal electric heat sources, and Programmable thermostat for all heaters in bedrooms.
6	<b>HIGH EFFICIENCY THERMAL ENVELOPE UA<sup>a</sup></b> Proposed UA 8 percent lower than the code UA
7	<b>GLAZING AREA</b> Glazing area, measured as the total of framed openings is less than 12 percent of conditioned floor area
8	<b>3 ACH AIR LEAKAGE CONTROL AND EFFICIENT VENTILATION</b> Achieve a maximum of 3.0 ACH50 whole-house air leakage when third-party tested and provide a whole-house ventilation system including heat recovery with a minimum sensible heat recovery efficiency of not less than 56 percent

# FLOOR PLAN LEGEND

ALL ITEMS PER PULTE SPECS - SEE SHEETS G0.01-G0.02

**WATER CLOSET:**  
MINIMUM CLEARANCE DIMENSIONS ARE TO FINISHED SURFACES: SIDES 15" AND FRONT 24"

**TOILET PAPER DISPENSER:**  
MOUNTING HEIGHT: + 24" ABOVE FINISHED FLOOR U.N.O. ON PLAN

**MIRRORED MEDICINE CABINET:**  
MOUNTING HEIGHT: + 50" ABOVE FINISHED FLOOR TO BOTTOM OF CABINET U.N.O. ON PLAN

**TOWEL BAR:**  
SIZE: 24" WIDE UNO ON PLAN  
MOUNTING HEIGHT: + 54" ABOVE FINISHED FLOOR UNO ON PLAN

**TOWEL RING:**  
MOUNTING HEIGHT: + 64" ABOVE FINISHED FLOOR UNO ON PLAN

**TUB / SHOWER COMBO:**  
14-1/2"x14-1/2" SOAP NICHE, BTM @ +42" AFF

**SLIDE-IN TUB:**  
SHOWER MIXING VALVE & HEAD @ TUB/SHOWER COMBO ONLY; SHOWER HEAD @ + 84"  
SHOWER CURTAIN ROD AT TUB/SHOWER COMBO ONLY  
SHOWER SURROUNDS @ MIN + 76" ABOVE DRAIN U.N.O. ON PLAN

**DROP-IN TUB:**  
TUB FAUCET  
+20" FRAMED RAISED PLATFORM TUB DECK, TUB DECK, SKIRT & BACKSPLASH  
TUB FAUCET

**SEPARATE DROP-IN TUB AND SHOWER:**  
SEAT @ +20"  
SLOPE 1/2":1"  
PER PLAN

9-1/2"x14-1/2" SOAP NICHE, BTM @ +42" AFF  
SHOWER SURROUNDS @ MIN + 76" ABOVE DRAIN U.N.O. ON PLAN  
SHOWER MIXING VALVE & SHOWER HEAD; SHOWER HEAD @ + 84"  
TEMPERED GLASS SHOWER DOOR(S) & ENCLOSURE

**SHOWER:**  
14-1/2"x14-1/2" SOAP NICHE, BTM @ +42" AFF  
SHOWER W/ SEAT  
SEAT @ +20"  
SLOPE 1/2":1"  
PER PLAN

SHOWER MIXING VALVE & SHOWER HEAD; SHOWER HEAD @ + 84"  
TEMPERED GLASS SHOWER DOOR(S) & ENCLOSURE  
SHOWER SURROUNDS @ MIN + 76" ABOVE DRAIN U.N.O. ON PLAN

**FRAMED WALK-IN SHOWER** - SEE DETAIL 136/AD  
**FULL GLASS WALK-IN SHOWER** - SEE DETAIL 137/AD  
**GLASS WALK-IN SHOWER** - SEE DETAIL 151/AD

**PEDESTAL SINK:**  
WALL MIRROR  
PEDESTAL SINK & FAUCET  
SINK & FAUCET  
BASE CABINET & COUNTER TOP W/ BACK SPLASH

**BATHROOM VANITY:**  
TANK WH FOR 102.5 OF WASHINGTON STATE CODE  
WH-IPRV  
WH  
EXPANSION TANK PER JURISDICTIONAL REQUIREMENTS

**WATER HEATERS:**  
TANKLESS WH (PRV PER MFC & JURISDICTION)  
INSTALL WH @ ABOVE FLOOR OR PROVIDE IMPACT PROTECTION

**TYPICAL REFRIGERATOR:**  
REF SPACE  
WATER SUPPLY BOX

**TYPICAL WASHER/DRYER:**  
RECESSED WASHER SUPPLY & DRAIN BOX  
SHELF / OPT CABINETS  
RECESSED DRYER VENT BOX - SEE 133/AD  
WASHER SPACE\*  
DRYER SPACE  
\*WASHER SPACE ALWAYS ON LEFT SIDE OF DRYER

**TYPICAL GAS RANGE:**  
GAS BOX - SEE DTL 134/AD

**ATTIC ACCESS:**  
22x30 ATTIC ACCESS; SEE 212/AD FOR ATTIC AND CRAWL DETAILS

**CRAWLSPACE VENT:**  
62 SQ IN VENT - VENT INSTALLED IN FLOOR SYSTEM RIM BOARD AT CRAWL; LOCATED PER PLAN

NOTE: SCALES NOTED ON DRAWINGS RELATE TO FULL SIZE PLOTS ON 22x34 SHEETS - 11x17 SHEETS REPRESENT 1/2 SCALE PLOTS

Seattle Division  
3535 Factoria Blvd SE  
Bellevue, Washington 98006



Product Change Requests

REV #	DATE / DESCRIPTION
1	10.21.22 INTERNAL REVIEW
2	
3	
4	
5	
6	
7	
8	
9	
10	

PROJECT TYPE  
Single Family

COMMUNITY NAME  
Frog Pond Crossing  
4000 Series  
LAWSON COMMUNITY ID  
8305

GARAGE HANDING  
Left

SPECIFICATION LEVEL  
Pulte

PLAN NAME  
Lynwood  
NFO PLAN NUMBER  
2374.401  
LAWSON PLAN ID  
40333  
LEGACY PLAN NUMBER / NAME  
4033-3

SHEET  
G0.10

ELEVATION C	
SPACE	AREA (SF)
A - Livable (First Floor)	1448
B - Livable (Second Floor)	1913
----- SUBTOTAL LIVABLE	3360
----- SUBTOTAL MAXIMUM LIVABLE	3360
C - Covered Patio	160
D - Garage	453
E - Porch	72
----- TOTAL STANDARD UNDER ROOF	4046
----- TOTAL STANDARD FOOTPRINT	2133
----- TOTAL MAXIMUM UNDER ROOF	4044
----- TOTAL MAXIMUM FOOTPRINT	2131

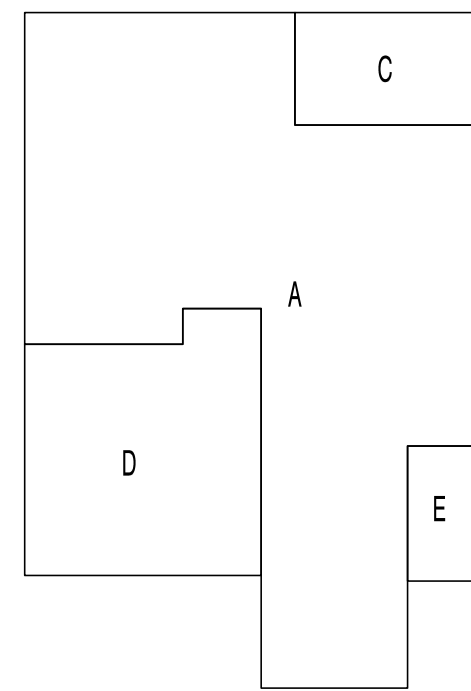

**ELEVATION 'C' - FIRST FLOOR**  
NOT TO SCALE

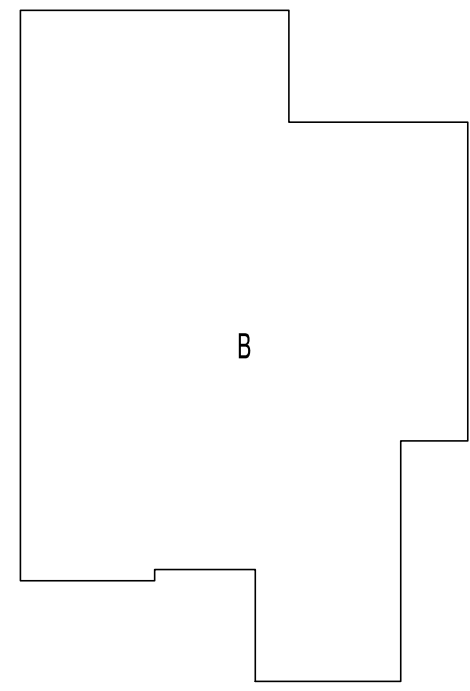

**ELEVATION 'C' - SECOND FLOOR**  
NOT TO SCALE

ELEVATION B	
SPACE	AREA (SF)
A - Livable (First Floor)	1448
B - Livable (Second Floor)	1913
----- SUBTOTAL LIVABLE	3360
----- SUBTOTAL MAXIMUM LIVABLE	3360
C - Covered Patio	160
D - Garage	453
E - Porch	72
----- TOTAL STANDARD UNDER ROOF	4046
----- TOTAL STANDARD FOOTPRINT	2133
----- TOTAL MAXIMUM UNDER ROOF	4044
----- TOTAL MAXIMUM FOOTPRINT	2131

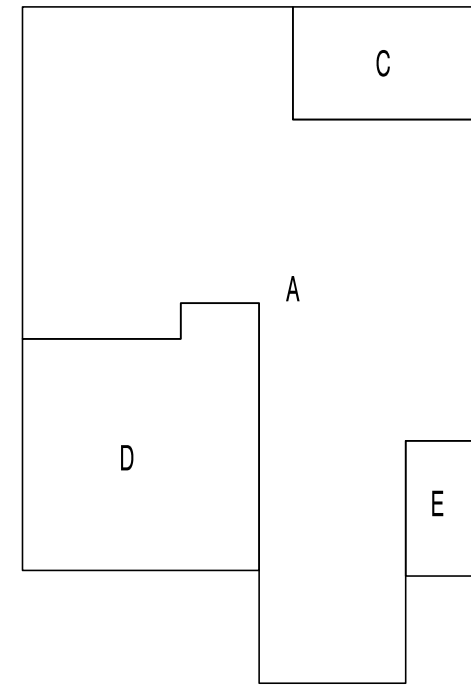

**ELEVATION 'B' - FIRST FLOOR**  
NOT TO SCALE

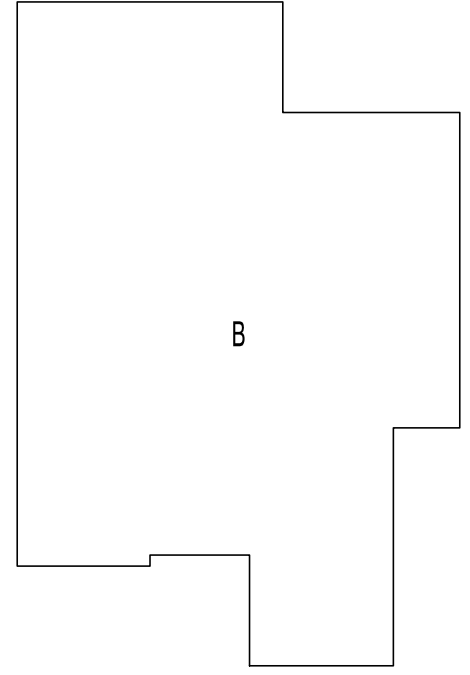

**ELEVATION 'B' - SECOND FLOOR**  
NOT TO SCALE

ELEVATION D	
SPACE	AREA (SF)
A - Livable (First Floor)	1448
B - Livable (Second Floor)	1913
----- SUBTOTAL LIVABLE	3360
----- SUBTOTAL MAXIMUM LIVABLE	3360
C - Covered Patio	160
D - Garage	453
E - Porch	72
----- TOTAL STANDARD UNDER ROOF	4046
----- TOTAL STANDARD FOOTPRINT	2133
----- TOTAL MAXIMUM UNDER ROOF	4044
----- TOTAL MAXIMUM FOOTPRINT	2133

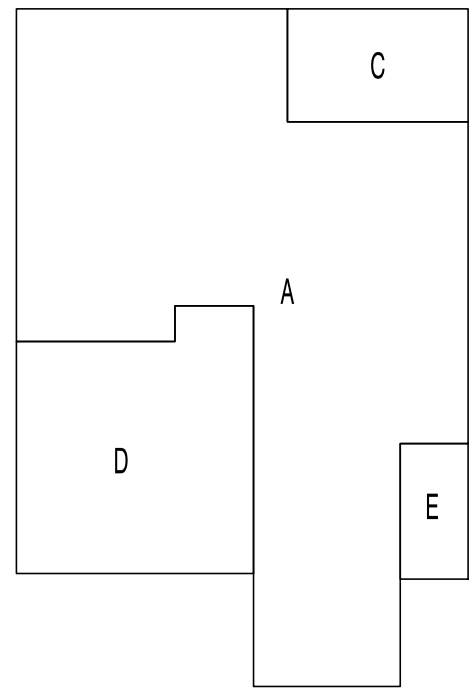

**ELEVATION 'D' - FIRST FLOOR**  
NOT TO SCALE

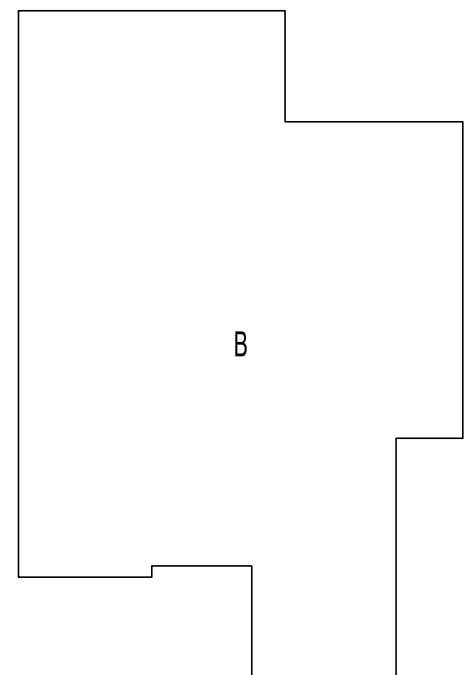

**ELEVATION 'D' - SECOND FLOOR**  
NOT TO SCALE

PRODUCTION MANAGER	
Josh DeVoll	
CURRENT RELEASE DATE: --/--	
REV #	DATE / DESCRIPTION
1	--
2	--
3	--
4	--
5	--
6	--
7	--
8	--
9	--
10	--

PROJECT TYPE  
**Single Family**

COMMUNITY NAME  
**Frog Pond Crossing  
4000 Series**  
LAWSON COMMUNITY ID  
**8305**

GARAGE HANDING  
**Left**

SPECIFICATION LEVEL  
**Pulte**

PLAN NAME  
**Lynwood**  
NPS PLAN NUMBER  
**2374.401**  
LAWSON PLAN ID  
**40333**  
LEGACY PLAN NUMBER / NAME  
**4033-3**

SHEET  
**G0.11**

NOTE: SCALES NOTED ON DRAWINGS RELATE TO FULL SIZE PLOTS ON 22x34 SHEETS - 11x17 SHEETS REPRESENT 1/2 SCALE PLOTS



CRAWL SPACE VENT CALCULATIONS					
CRAWL SPACE ZONE	CRAWL SPACE SQ INCHES	VENT RATIO	SQ INCHES PER VENT	REQUIRED	PROVIDED
1	208,453	1/300	62	11.2	14

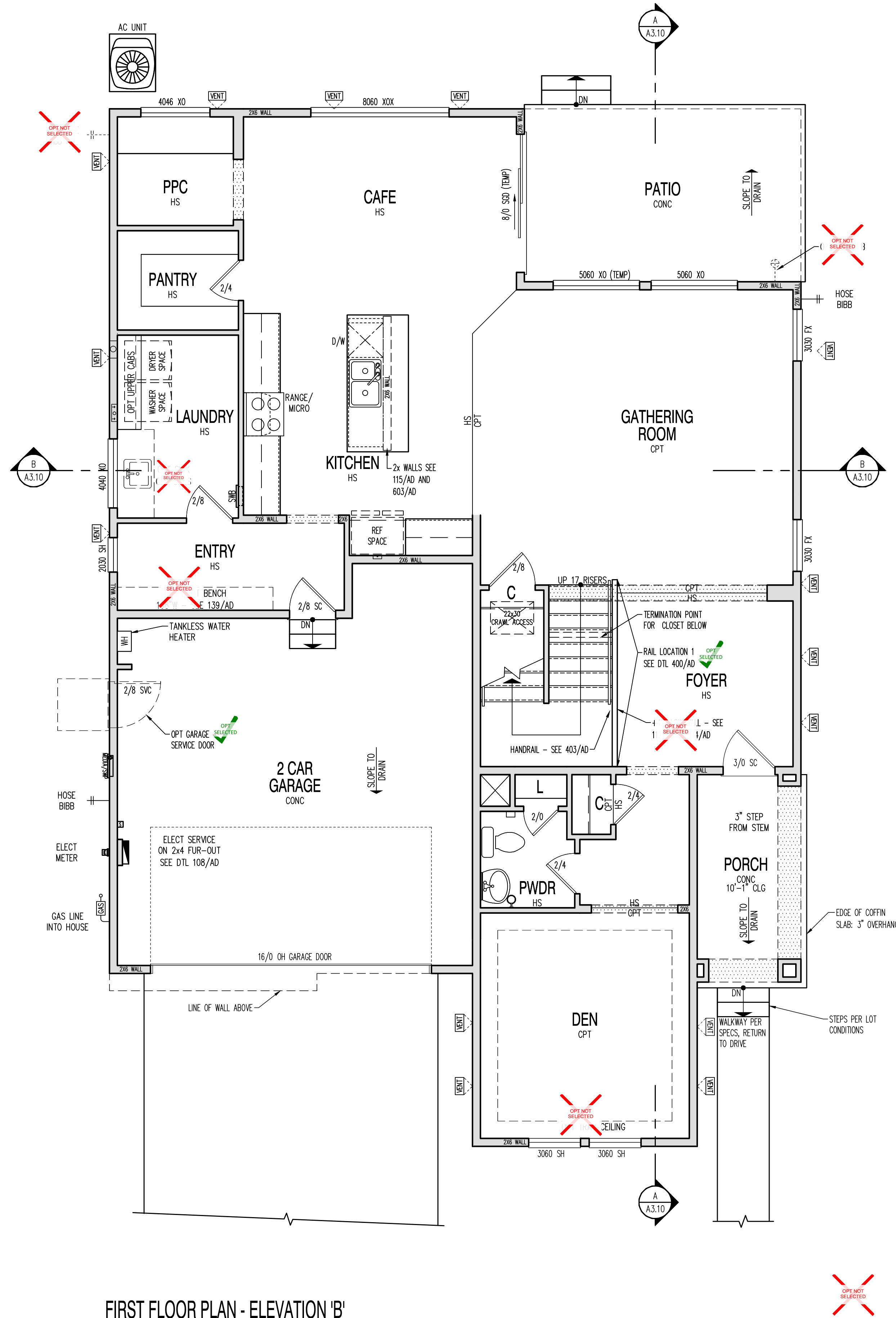

FIRST FLOOR PLAN - ELEVATION 'B'

SCALE: 1/4" = 1'-0"

GENERAL FLOOR PLAN NOTES

- SEE FLOOR PLAN LEGEND ON SHEET 00.10 FOR BATH, KITCHEN & LAUNDRY NOTES.
- SEE GENERAL ARCHITECTURAL NOTES & SPECIFICATIONS FOR MATERIALS, & FINISHES.
- ALL DOOR AND WINDOW GLAZING SHALL MEET THE REQUIREMENTS OF THE IRC, WHETHER SPECIFICALLY IDENTIFIED OR NOT ON THE PLANS.
- DIMENSIONS OF FLOOR PLAN(S) ARE SHOWN TO FACE OF STUD TYPICALLY UNLESS OTHERWISE NOTED. CONTRACTOR TO VERIFY ROUGH OPENING REQUIREMENTS OF ALL DOOR AND WINDOW UNITS PRIOR TO START OF CONSTRUCTION.
- SEE GENERAL ARCHITECTURAL NOTES, DIVISION 6, FOR FIRE / DRAFT STOPS.
- CLOTHES DRYER EXHAUST DUCT PER IRC.
- REFRIGERATOR SPACE SHALL BE PRE-PLUMBED FOR ICEMAKER.
- TUB / SHOWER SURROUND SHALL BE INSTALLED OVER ONE LAYER OF DENSISHELD OR APPROVED EQUAL.
- ALL CLOSETS HAVE STANDARD 1 ROD AND 1 SHELF UNO - SEE DTL 111/AD.
- ALL LINEN AND PANTRY SHELVING SIZES PER DTL 111/AD.
- INSTALL STONE OR BRICK VENEER PER MANUFACTURER SPECS.
- OPT GARAGE SERVICE DOOR TO BE STEEL, W/ 36" SQ CONC STOOP.
- PROVIDE 3/2" GYPSUM BOARD AT GARAGE CEILING(S), AT ALL GARAGE WALLS COMMON TO HOUSE INTERIOR SPACES, ENCLOSED SPACES UNDER STAIRS, AND AT ALL WALLS SUPPORTING FRAMING FOR FIRE RATED CEILINGS. PROVIDE 5/8" TYPE 'X' GYPSUM BOARD AT GARAGE CEILINGS BELOW HABITABLE SPACE. PROVIDE 1/2" SAG-RESISTANT OR 3/8" GYPSUM BOARD AT ALL CEILINGS. REFER TO PLANS FOR ADDITIONAL FIRE RATING REQUIREMENTS.
- COMBUSTION AIR VENTS AT GAS WATER HEATER ONLY: TO BE (2) 14" x 8", 12" @ ABV FLOOR & 12" BELOW CLG.
- GARAGE ENTRY DOORS TO BE 1 3/4" THICK SELF-CLOSING, SELF-LATCHING, SELF-SEALING DOOR W/ GASKET, THRESHOLD, SWEEP, SOLID CORE WOOD OR SOLID OR HONEY COMB STEEL DOOR OR 20 MINUTE FIRE RATED.
- GARAGE SHALL SLOPE TO -3" AT THE OVERHEAD GARAGE DOOR.
- ALL EXTERIOR LIVEABLE WALLS AND GARAGE WALLS TO BE 2X6 UNO ON PLAN.
- SEE DETAIL 910/AD FOR KITCHEN ISLAND VENT AIR GAP.
- SEE 605/AD AND 606/AD FOR WAINSCOT DETAILS.
- SEE 134/AD FOR GAS BOX AT RANGE DETAIL.
- AHU CLOSET & UNFINISHED BASEMENT STORAGE ROOM DOORS TO BE 1 3/4" THICK SELF-CLOSING, SELF-LATCHING, SELF-SEALING DOOR W/ GASKET.

FLOOR PLAN LEGEND

CEILING SOFFIT:  
TYPICAL WOOD  
FRAMED SOFFITS:

STANDARD INTERIOR FLAT SOFFIT HEIGHTS (SEE DTL 113/AD):  
 +7'-1" AFF SOFFIT HEIGHT UNO ON PLAN @ STANDARD 8'-1" PLATE HEIGHT  
 +8'-1" AFF SOFFIT HEIGHT UNO ON PLAN @ STANDARD 9'-1" PLATE HEIGHT  
 +8'-7" AFF SOFFIT HEIGHT UNO ON PLAN @ STANDARD 10'-1" PLATE HEIGHT

STANDARD EXTERIOR FLAT SOFFIT HEIGHTS UNO ON ELEVATIONS:  
 +7'-7" AFF SOFFIT HEIGHT UNO ON ELEVATION @ STANDARD 8'-1" PLATE HEIGHT  
 +8'-7" AFF SOFFIT HEIGHT UNO ON ELEVATION @ STANDARD 9'-1" PLATE HEIGHT  
 +9'-7" AFF SOFFIT HEIGHT UNO ON ELEVATION @ STANDARD 10'-1" PLATE HEIGHT

WALL NICHES:  
TOP OF NICHE TO BE PER PLAN SOFFIT HEIGHT  
BOTTOM OF NICHE TO BE +42"  
WIDTH OF NICHE TO BE PER PLAN

OPTIONAL TRAY CEILING:  
12" WIDE X 5-1/2" DEEP, UNO ON PLAN  
TRAY CEILING @ +91-1/2" AFF UNO ON PLAN @ STD 8'-1" PLATE HGT.  
TRAY CEILING @ +103-1/2" AFF UNO ON PLAN @ STD 9'-1" PLATE HGT.  
TRAY CEILING @ +115-1/2" AFF UNO ON PLAN @ STD 10'-1" PLATE HGT.

DOOR AND WINDOW HEADERS

EXTERIOR DOOR HEIGHTS (SEE DTLS 126, 127/AD):

- ALL EXTERIOR DOORS TO BE 8'-0" TALL UNO ON PLAN
- ALL SDOs TO MATCH THAT FLOOR'S WINDOW HEADER HEIGHTS UNO ON PLAN

EXCEPTIONS: GARAGE SERVICE DOOR TO BE 6'-8" TALL UNO ON PLAN  
OVERHEAD GARAGE DOOR(S) TO BE 8'-0" TALL UNO ON PLAN (SEE DTLS 128, 129/AD)

DOOR LOCATIONS:  
ALL DOORS NOT DIMENSIONED ARE 4" OFF A CORNER OR CENTERED IN A SPACE  
CONTINUOUS HORIZONTAL BLOCKING IS REQUIRED FOR BARN DOOR RAILS ABOVE  
DOOR HEADER AND FOR FULL WIDTH OF BARN DOOR RAIL

INTERIOR DOOR HEIGHTS:  
ALL DOORS TO BE 6'-8" TALL UNO ON PLAN

NOTE:  
8' TALL DOOR OPTION ONLY OFFERED ON 9'-1" PLATE FLOORS

EXTERIOR WINDOW HEADER HEIGHT:  
 • 7'-0" HEADER HEIGHT 2ND FLOOR, UNO ON PLAN  
 • 8'-0" HEADER HEIGHT 1ST FLOOR, UNO ON PLAN  
 • 7'-0" HEADER HEIGHT BASEMENT, UNO ON PLAN

CEILING HEIGHTS

INTERIOR CEILING HEIGHTS

- 8'-1" PLATE HEIGHT 2ND FLOOR, UNO ON PLAN
- 9'-1" PLATE HEIGHT 1ST FLOOR, UNO ON PLAN
- 8'-1" PLATE HEIGHT BASEMENT, UNO ON PLAN

DRAFTSTOP NOTE:  
CONCEALED 1ST AND 2ND FLOOR SYSTEM ASSEMBLIES SHALL HAVE DRAFTSTOPS SO NO FLOOR SPACE IN AN ASSEMBLY IS MORE THAN 1,000 SQ FT PER IRC R302.12.

LOT 7 - OPTION LIST  
 ELEVATION C  
 CHEF KITCHEN  
 EXECUTIVE ISLAND  
 PRE-PLUMB LAUNDRY  
 GARAGE SERVICE DOOR  
 BEDROOM AND BATH  
 COVERED PATIO  
 INTERIOR FIREPLACE 2  
 RAIL LOCATION 1  
 FREESTANDING TUB  
 TRAY CEILING -  
 OWNER'S SUITE  
 SINK - BATH 2

Seattle Division  
 3535 Factoria Blvd SE  
 Bellevue, Washington 98006



Noted First Floor Plan  
 All Elevations

REV #	DATE / DESCRIPTION
1	---
2	---
3	---
4	---
5	---
6	---
7	---
8	---
9	---
10	---

PRODUCTION MANAGER  
 Josh DeVoll  
 CURRENT RELEASE DATE: /-/-

PROJECT TYPE  
 Single Family

COMMUNITY NAME  
 Frog Pond Crossing  
 4000 Series  
 LAWSON COMMUNITY ID  
 8305

GARAGE HANDING  
 Left

SPECIFICATION LEVEL  
 Pulte

PLAN NAME  
 Lynwood  
 NPI PLAN NUMBER  
 2374.401  
 LAWSON PLAN ID  
 40333  
 LEGACY PLAN NUMBER / NAME  
 4033-3

SHEET  
 A1.10

PLOTTED: September 27, 2022 / Ennio Copeland / 4033-3-WZ-PLAN.DWG  
 (c) Copyright PulteGroup, Inc. - 2022  
 NOTE: SCALES NOTED ON DRAWINGS RELATE TO FULL SIZE PLOTS ON 22x34 SHEETS - 11x17 SHEETS REPRESENT 1/2 SCALE PLOTS

GENERAL FLOOR PLAN NOTES

1. REFER TO STANDARD PLAN FOR INFORMATION NOT SHOWN

Seattle Division  
3535 Factoria Blvd SE  
Bellevue, Washington 98006



Floor Plan Options  
Elevations 'B' & 'C'

REV #	DATE	DESCRIPTION
1		
2		
3		
4		
5		
6		
7		
8		
9		
10		

PROJECT TYPE  
Single Family

COMMUNITY NAME  
Frog Pond Crossing  
4000 Series  
LAWSON COMMUNITY ID  
8305

GARAGE HANDING  
Left

SPECIFICATION LEVEL  
Pulte

PLAN NAME  
Lynwood  
N/C PLAN NUMBER  
2374.401  
LAWSON PLAN ID  
40333  
LEGACY PLAN NUMBER / NAME  
4033-3

SHEET  
A1.12

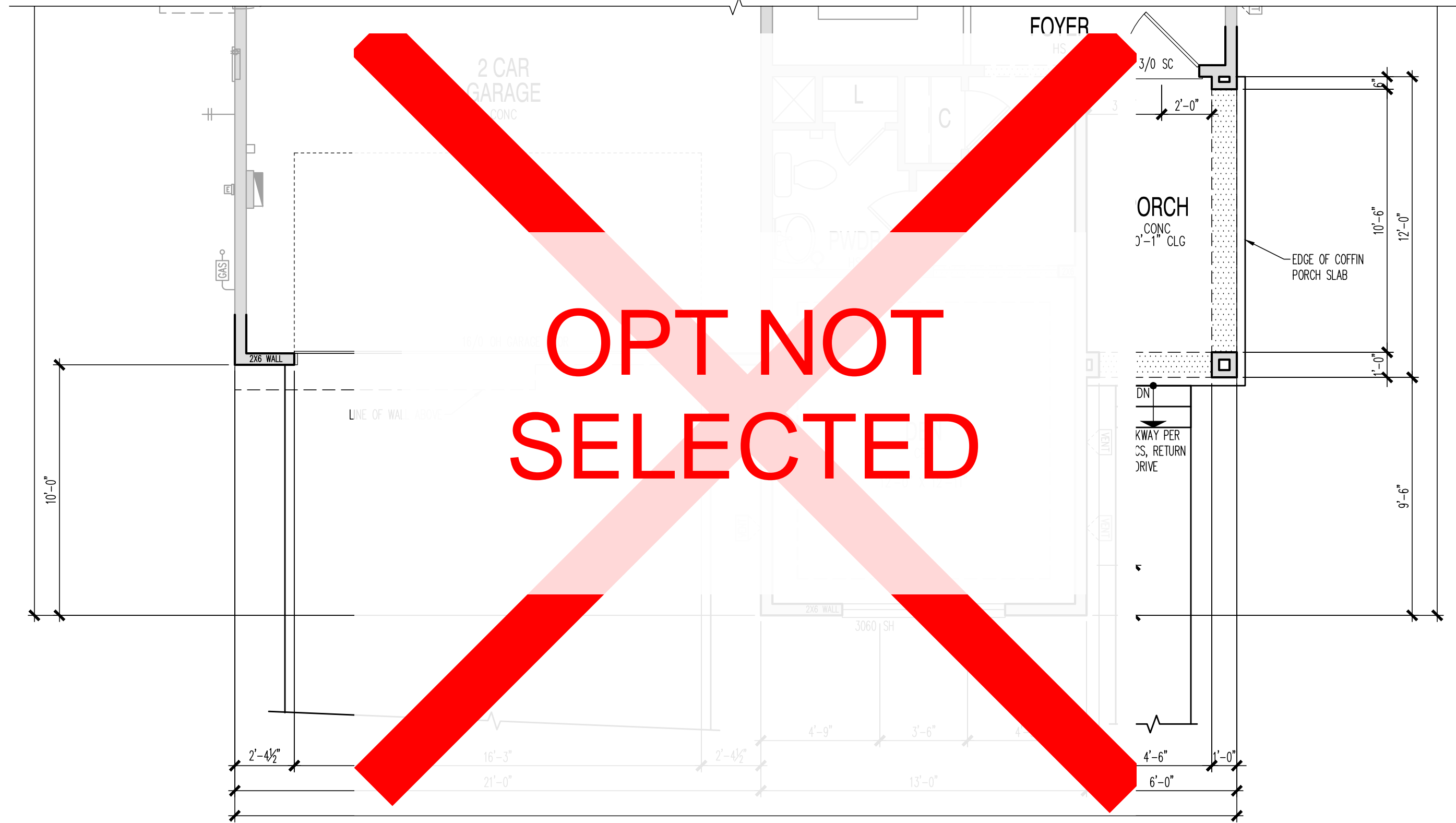

FIRST FLOOR PLAN - ELEVATION 'D'

SCALE: 1/4" = 1'-0"

OPT 70505

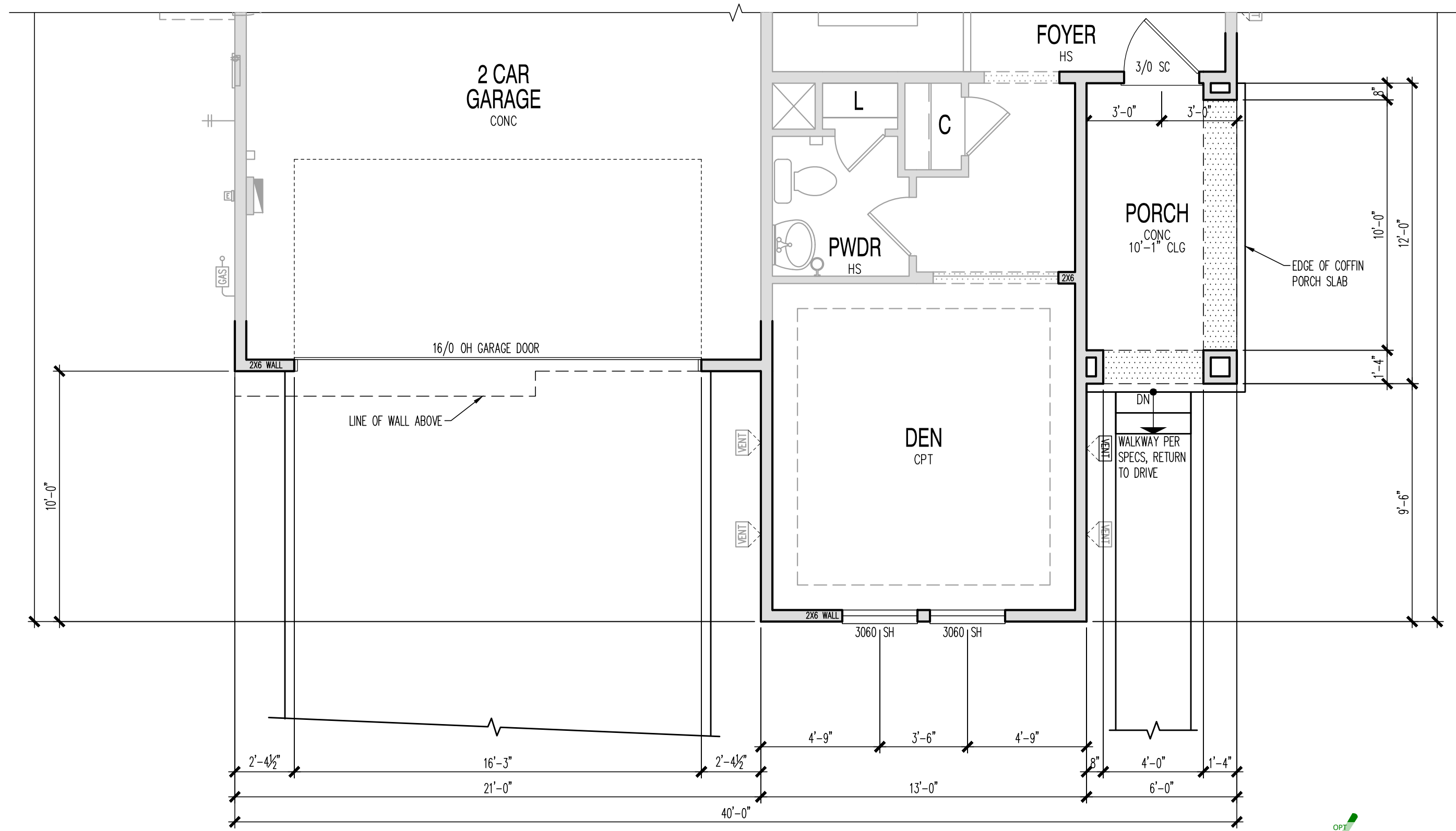

FIRST FLOOR PLAN - ELEVATION 'C'

SCALE: 1/4" = 1'-0"

OPT 70503



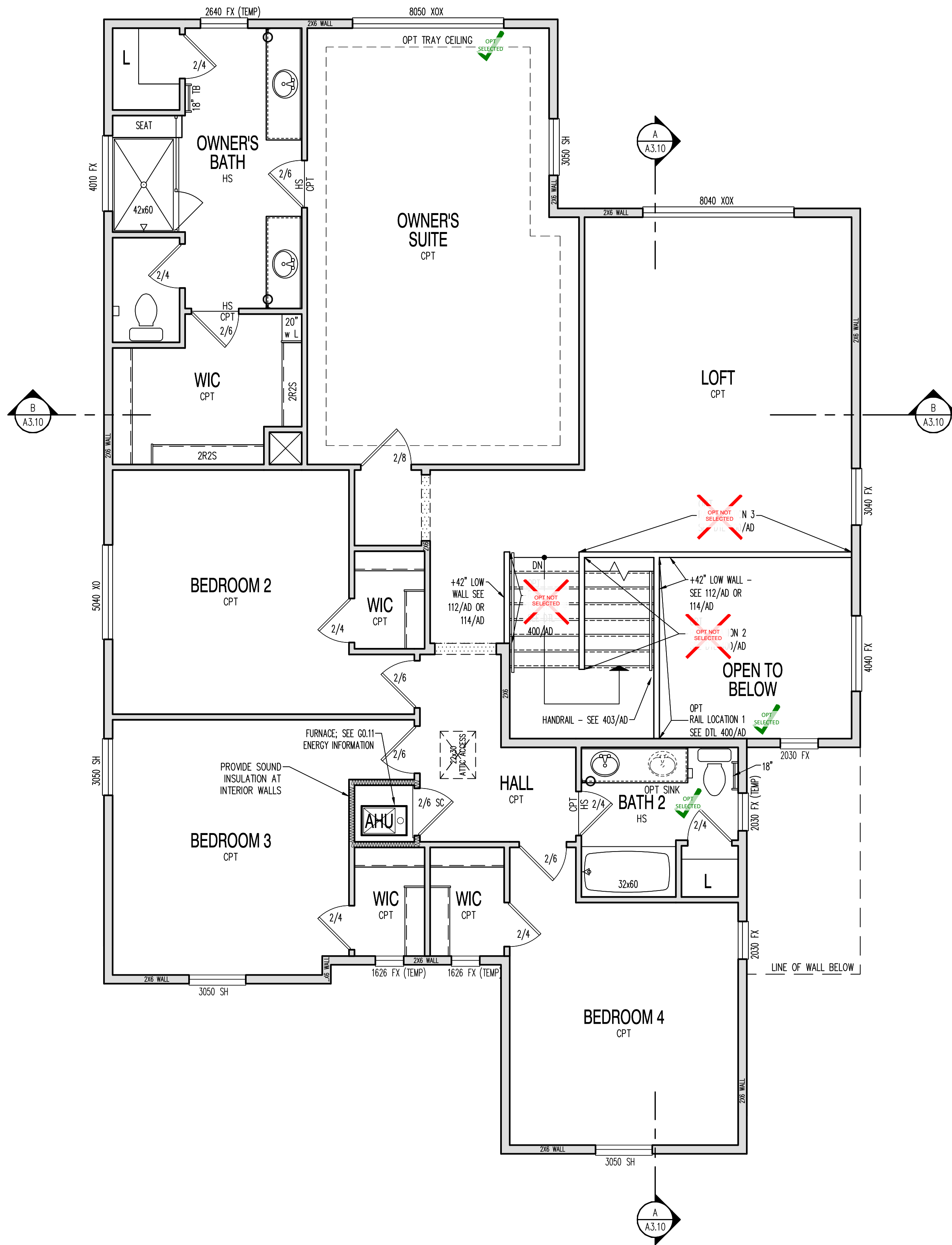

**SECOND FLOOR PLAN - ELEVATION 'B'**

SCALE: 1/4" = 1'-0"

**GENERAL FLOOR PLAN NOTES**

- SEE FLOOR PLAN LEGEND ON SHEET 00.10 FOR BATH, KITCHEN & LAUNDRY NOTES.
- SEE GENERAL ARCHITECTURAL NOTES & SPECIFICATIONS FOR MATERIALS, & FINISHES.
- ALL DOOR AND WINDOW GLAZING SHALL MEET THE REQUIREMENTS OF THE IRC, WHETHER SPECIFICALLY IDENTIFIED OR NOT ON THE PLANS.
- DIMENSIONS OF FLOOR PLAN(S) ARE SHOWN TO FACE OF STUD TYPICALLY UNLESS OTHERWISE NOTED. CONTRACTOR TO VERIFY ROUGH OPENING REQUIREMENTS OF ALL DOOR AND WINDOW UNITS PRIOR TO START OF CONSTRUCTION.
- SEE GENERAL ARCHITECTURAL NOTES, DIVISION 6, FOR FIRE / DRAFT STOPS.
- CLOTHES DRYER EXHAUST DUCT PER IRC.
- REFRIGERATOR SPACE SHALL BE PRE-PLUMBED FOR ICEMAKER.
- TUB / SHOWER SURROUND SHALL BE INSTALLED OVER ONE LAYER OF DENS-SHIELD OR APPROVED EQUAL.
- ALL CLOSETS HAVE STANDARD 1 ROD AND 1 SHELF UNO - SEE DTL 111/AD.
- ALL LINEN AND PANTRY SHELVING SIZES PER DTL 111/AD.
- INSTALL STONE OR BRICK VENEER PER MANUFACTURER SPECS.
- OPT GARAGE SERVICE DOOR TO BE STEEL, w/ 36" SQ CONC STOOP.
- PROVIDE 3/2" GYPSUM BOARD AT GARAGE CEILING(S), AT ALL GARAGE WALLS COMMON TO HOUSE INTERIOR SPACES, ENCLOSED SPACES UNDER STAIRS, AND AT ALL WALLS SUPPORTING FRAMING FOR FIRE RATED CEILINGS. PROVIDE 5/8" TYPE 'X' GYPSUM BOARD AT GARAGE CEILINGS BELOW HABITABLE SPACE. PROVIDE 1/2" SAG-RESISTANT OR 5/8" GYPSUM BOARD AT ALL CEILINGS. REFER TO PLANS FOR ADDITIONAL FIRE RATING REQUIREMENTS.
- COMBUSTION AIR VENTS AT GAS WATER HEATER ONLY: TO BE (2) 14" x 8", 12" @ ABV FLOOR & 12" BELOW CLG.
- GARAGE ENTRY DOORS TO BE 1 3/4" THICK SELF-CLOSING, SELF-LATCHING, SELF-SEALING DOOR w/ GASKET, THRESHOLD, SWEEP, SOLID CORE WOOD OR SOLID OR HONEY COMB STEEL DOOR OR 20 MINUTE FIRE RATED.
- GARAGE SHALL SLOPE TO -3" AT THE OVERHEAD GARAGE DOOR.
- SEE DETAIL 910/AD FOR KITCHEN ISLAND VENT AIR GAP.
- SEE 605/AD AND 606/AD FOR MAINSCOT DETAILS.
- SEE 134/AD FOR GAS BOX AT RANGE DETAIL.
- AHU CLOSET & UNFINISHED BASEMENT STORAGE ROOM DOORS TO BE 1 3/4" THICK SELF-CLOSING, SELF-LATCHING, SELF-SEALING DOOR w/ GASKET.

**FLOOR PLAN LEGEND**

CEILING SOFFIT:  
TYPICAL WOOD  
FRAMED SOFFITS:

STANDARD INTERIOR FLAT SOFFIT HEIGHTS (SEE DTL 113/AD):  
 +7'-1" AFF SOFFIT HEIGHT UNO ON PLAN @ STANDARD 8'-1" PLATE HEIGHT  
 +8'-1" AFF SOFFIT HEIGHT UNO ON PLAN @ STANDARD 9'-1" PLATE HEIGHT  
 +8'-7" AFF SOFFIT HEIGHT UNO ON PLAN @ STANDARD 10'-1" PLATE HEIGHT

STANDARD EXTERIOR FLAT SOFFIT HEIGHTS UNO ON ELEVATIONS:  
 +7'-7" AFF SOFFIT HEIGHT UNO ON ELEVATION @ STANDARD 8'-1" PLATE HEIGHT  
 +8'-7" AFF SOFFIT HEIGHT UNO ON ELEVATION @ STANDARD 9'-1" PLATE HEIGHT  
 +9'-7" AFF SOFFIT HEIGHT UNO ON ELEVATION @ STANDARD 10'-1" PLATE HEIGHT

WALL NICHES:  
 TOP OF NICHE TO BE PER PLAN SOFFIT HEIGHT  
 BOTTOM OF NICHE TO BE +42"  
 WIDTH OF NICHE TO BE PER PLAN

OPTIONAL TRAY CEILING:  
 12" WIDE X 5-1/2" DEEP, UNO ON PLAN  
 TRAY CEILING @ +91'-1/2" AFF UNO ON PLAN @ STD 8'-1" PLATE HGT.  
 TRAY CEILING @ +103'-1/2" AFF UNO ON PLAN @ STD 9'-1" PLATE HGT.  
 TRAY CEILING @ +115'-1/2" AFF UNO ON PLAN @ STD 10'-1" PLATE HGT.

**DOOR AND WINDOW HEADERS**

- EXTERIOR DOOR HEIGHTS (SEE DTLS 126, 127/AD):
- ALL EXTERIOR DOORS TO BE 8'-0" TALL UNO ON PLAN
  - ALL SDOs TO MATCH THAT FLOOR'S WINDOW HEADER HEIGHTS UNO ON PLAN
- EXCEPTIONS: GARAGE SERVICE DOOR TO BE 6'-8" TALL UNO ON PLAN  
 OVERHEAD GARAGE DOOR(S) TO BE 8'-0" TALL UNO ON PLAN  
 (SEE DTLS 128, 129/AD)
- DOOR LOCATIONS:  
 ALL DOORS NOT DIMENSIONED ARE 4" OFF A CORNER OR CENTERED IN A SPACE  
 CONTINUOUS HORIZONTAL BLOCKING IS REQUIRED FOR BARN DOOR RAILS ABOVE  
 DOOR HEADER AND FOR FULL WIDTH OF BARN DOOR RAIL
- INTERIOR DOOR HEIGHTS:  
 ALL DOORS TO BE 6'-8" TALL UNO ON PLAN
- NOTE:  
 8' TALL DOOR OPTION ONLY OFFERED ON 9'-1" PLATE FLOORS
- EXTERIOR WINDOW HEADER HEIGHTS:  
 • 7'-0" HEADER HEIGHT 2ND FLOOR, UNO ON PLAN  
 • 8'-0" HEADER HEIGHT 1ST FLOOR, UNO ON PLAN  
 • 7'-0" HEADER HEIGHT BASEMENT, UNO ON PLAN

**CEILING HEIGHTS**

- INTERIOR CEILING HEIGHTS
- 8'-1" PLATE HEIGHT 2ND FLOOR, UNO ON PLAN
  - 9'-1" PLATE HEIGHT 1ST FLOOR, UNO ON PLAN
  - 8'-1" PLATE HEIGHT BASEMENT, UNO ON PLAN
- DRAFTSTOP NOTE:  
 CONCEALED 1ST AND 2ND FLOOR SYSTEM ASSEMBLIES SHALL HAVE DRAFTSTOPS SO NO FLOOR SPACE IN AN ASSEMBLY IS MORE THAN 1,000 SQ FT PER IRC R302.12.

Seattle Division  
 3535 Factoria Blvd SE  
 Bellevue, Washington 98006



Noted First Floor Plan  
 All Elevations

PRODUCTION MANAGER  
 Josh DeVoll  
 CURRENT RELEASE DATE: /-/-

REV #	DATE	DESCRIPTION
1		
2		
3		
4		
5		
6		
7		
8		
9		
10		

PROJECT TYPE  
**Single Family**

COMMUNITY NAME  
**Frog Pond Crossing  
 4000 Series**

LAWSON COMMUNITY ID  
**8305**

GARAGE HANDING  
**Left**

SPECIFICATION LEVEL  
**Pulte**

PLAN NAME  
**Lynwood**

NSI PLAN NUMBER  
**2374.401**

LAWSON PLAN ID  
**40333**

LEGACY PLAN NUMBER / NAME  
**4033-3**

SHEET  
**A1.20**

NOTE: SCALES NOTED ON DRAWINGS RELATE TO FULL SIZE PLOTS ON 22x34 SHEETS - 11x17 SHEETS REPRESENT 1/2 SCALE PLOTS

GENERAL FLOOR PLAN NOTES

1. REFER TO STANDARD PLAN FOR INFORMATION NOT SHOWN

© Copyright PulteGroup, Inc. - 2022

**Seattle Division**  
3535 Factoria Blvd SE  
Bellevue, Washington 98006



Floor Plan Options  
Elevations 'B' & 'C'

PRODUCTION MANAGER  
Josh DeVoll  
CURRENT RELEASE DATE: /-/

REV #	DATE	DESCRIPTION
△	--	--
△	--	--
△	--	--
△	--	--
△	--	--
△	--	--
△	--	--
△	--	--

PROJECT TYPE  
Single Family

COMMUNITY NAME  
Frog Pond Crossing  
4000 Series  
LAWSON COMMUNITY ID  
8305

GARAGE HANDING  
Left

SPECIFICATION LEVEL  
Pulte

PLAN NAME  
Lynwood  
NFC PLAN NUMBER  
2374.401  
LAWSON PLAN ID  
40333  
LEGACY PLAN NUMBER / NAME  
4033-3

SHEET  
A1.22

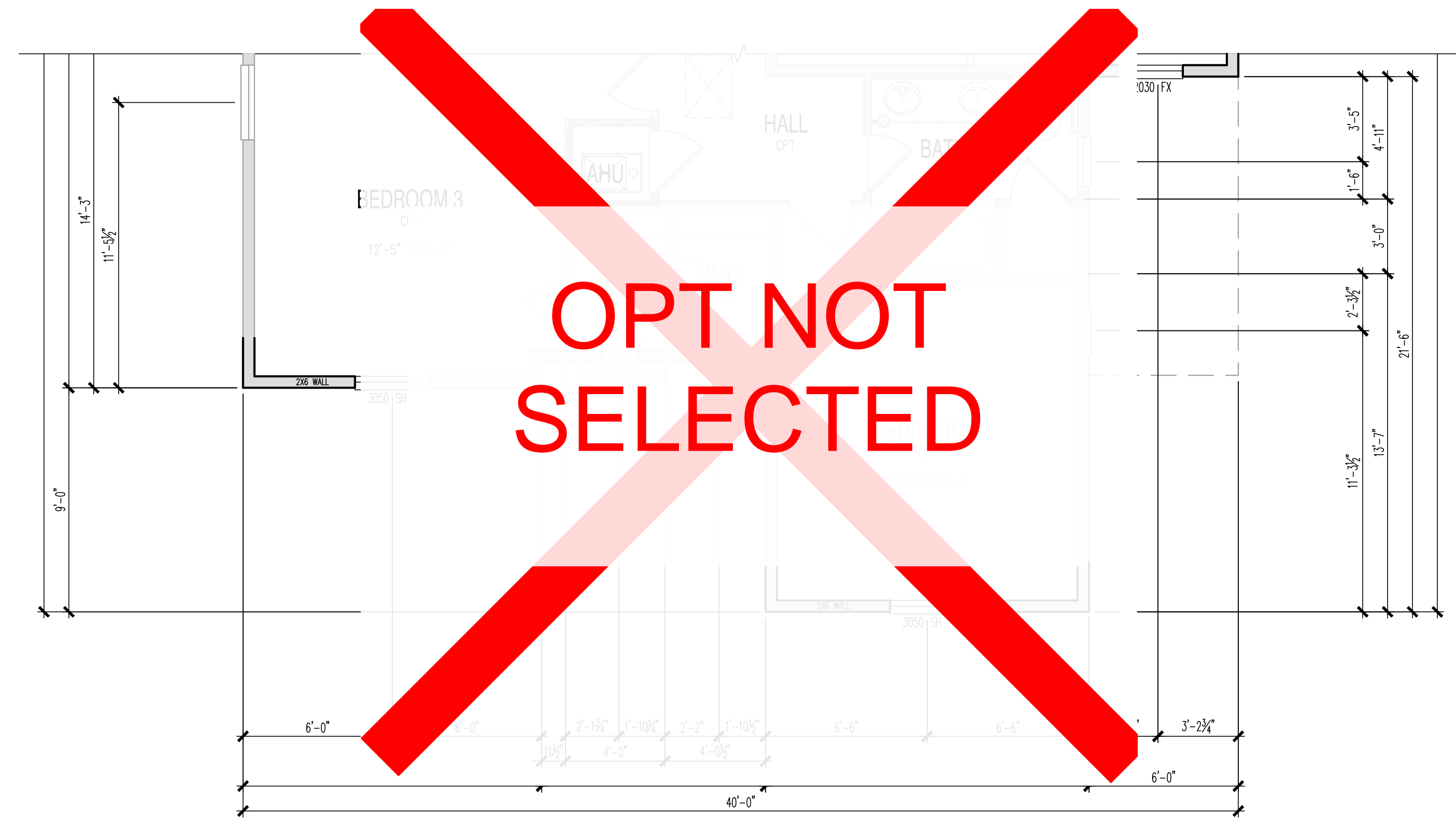

SECOND FLOOR PLAN - ELEVATION 'D'

SCALE: 1/4" = 1'-0"

OPT 70505

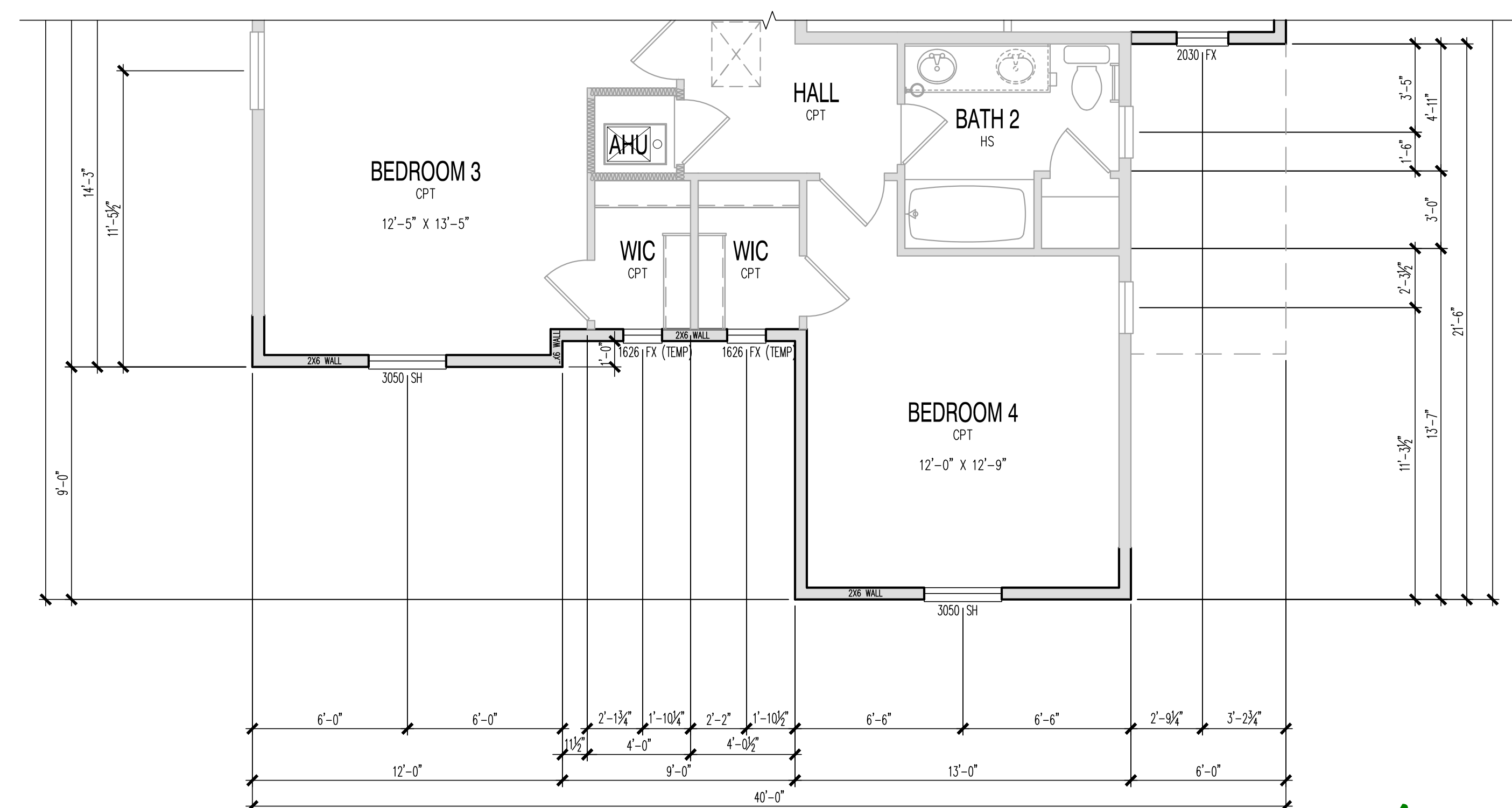

SECOND FLOOR PLAN - ELEVATION 'C'

SCALE: 1/4" = 1'-0"

OPT 70503

PLOTTED: September 27, 2022 / Emma Copeland / 4033-3-WZ-PLAN-OPTS.DWG



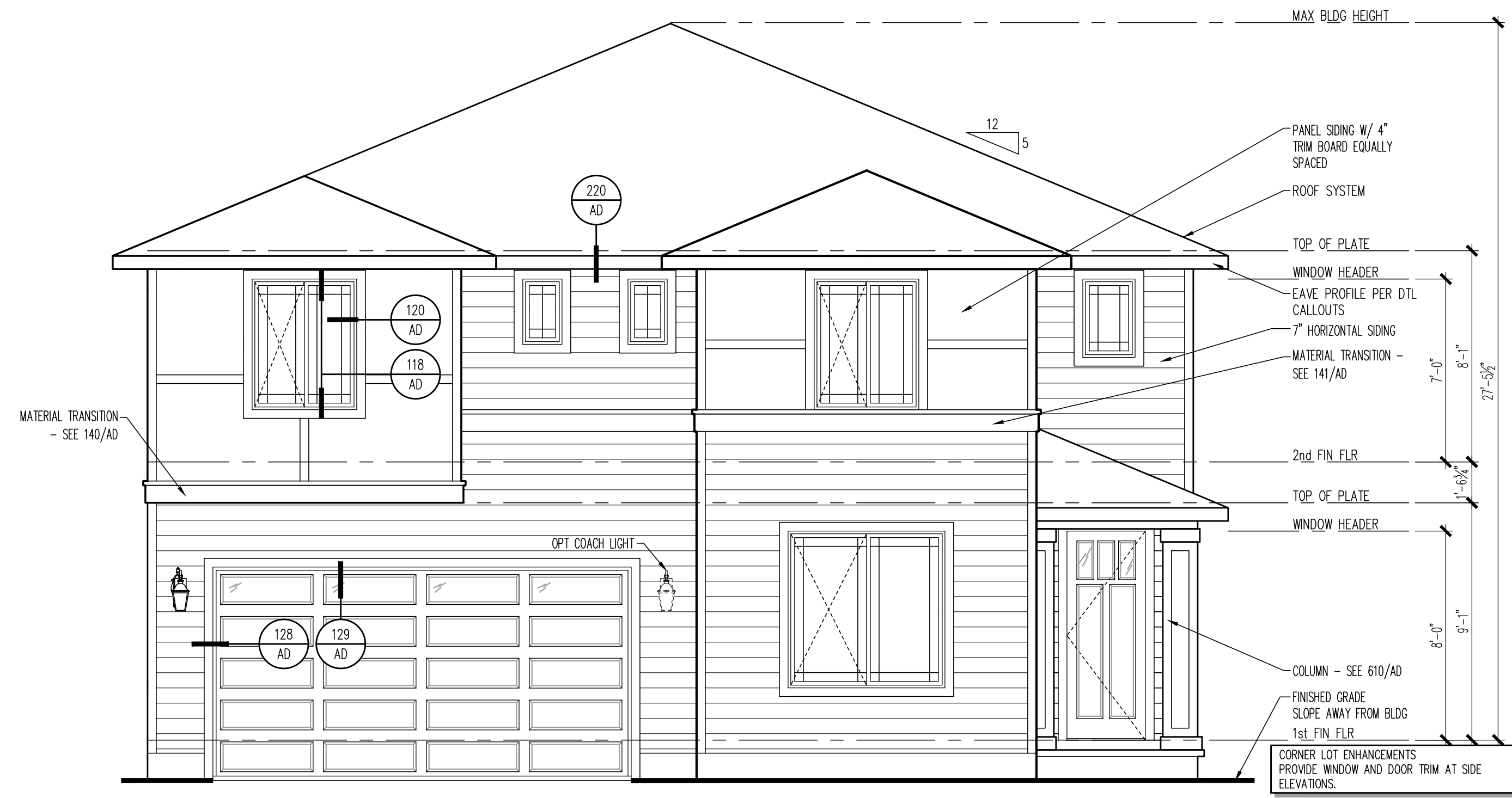

FRONT ELEVATION 'C'

SCALE: 1/4" = 1'-0"

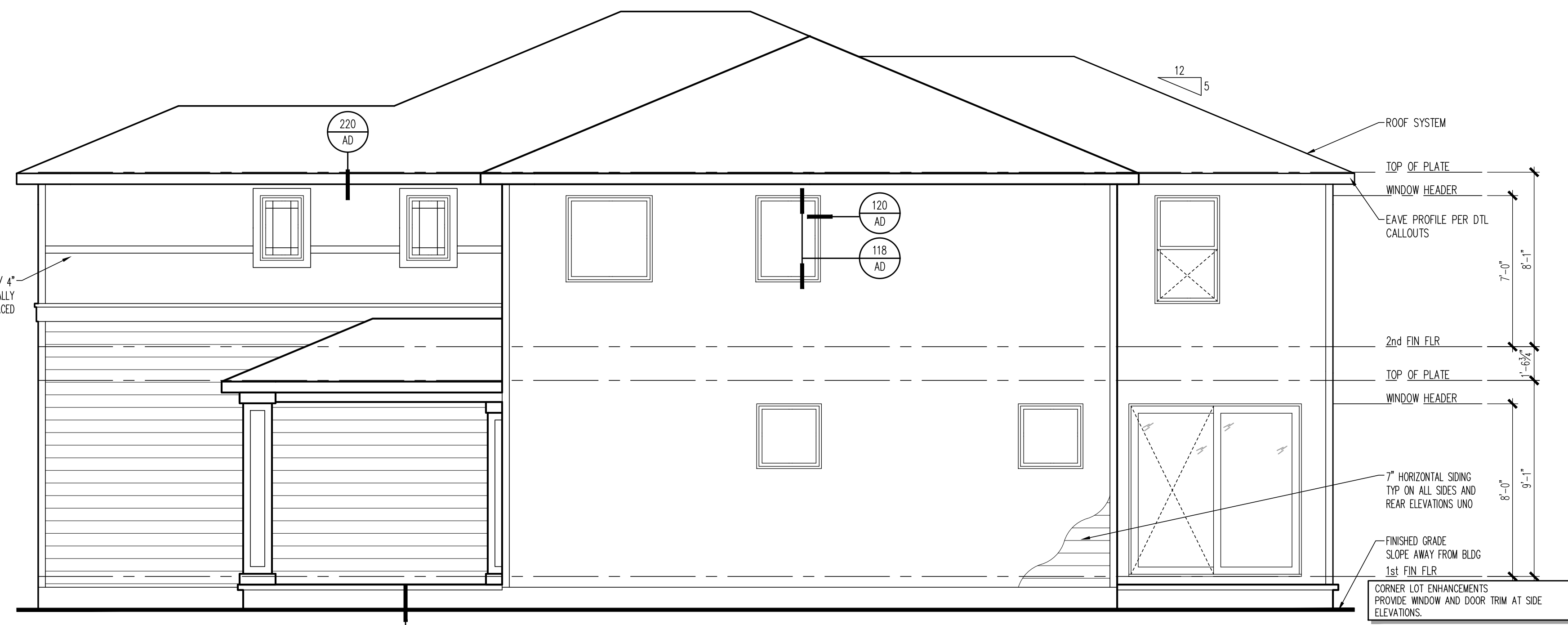

RIGHT ELEVATION 'C'

SCALE: 1/4" = 1'-0"

### GENERAL EXTERIOR ELEV NOTES

- SIDING PER SPECS UNO.
- ROOF PER SPECS UNO.
- MANUFACTURED STONE OR BRICK VENEER PER SPECS.
- PROVIDE POSITIVE DRAINAGE AWAY FROM BUILDING.
- ALL NON-VERTICAL SURFACES TO BE SLOPED MIN  $\frac{1}{8}$ " PER 12" AND WATER-PROOFED WITH ONE LAYER OF BITHTHANE WATERPROOF MEMBRANE. PATIO, PORCH AND BREEZEWAY CEILINGS TO BE FINISHED WITH EXTERIOR GRADE OYPSUM BOARD UNO ON PLANS OR ELEVATIONS.
- EXTERIOR LIGHT FIXTURE MOUNTING HEIGHT: -9" BELOW GARAGE DOOR HEADER TO CENTER LINE OF ELECTRICAL BOX UNO ON PLANS OR ELEVATIONS.
- ADDRESS SIGN MOUNTING HEIGHT: -25" BELOW GARAGE DOOR HEADER TO CENTER LINE OF ELECTRICAL BOX UNO ON PLANS OR ELEVATIONS.
- WALL PENETRATIONS:
1. WINDOWS: SEE DETAIL 117/AD, 118/AD AND 120/AD.
2. SWING DOORS: SEE DETAILS 125/AD, 126/AD AND 127/AD.
3. SLIDING GLASS DOORS: SEE DETAILS 120/AD, 121/AD AND 150/AD.
4. ALL PENETRATIONS TO BE FLASHED, CAULKED AND SEALED AS REQUIRED.
- SIDING INSIDE CORNERS: SEE DETAIL 130/AD.
- PROVIDE 1 HOUR FIRE PROTECTION AT UNDERSIDE OF EAVES THAT ENCRORACH WITHIN THE 5'-0" SIDE YARD SETBACK PER TABLE R302.1(1)

### WINDOW POPOUTS

- THERE SHALL BE SEALANT BETWEEN WINDOW FLANGE & SIDING.
- DIMENSION ARE AS SHOWN UNO ON PLAN

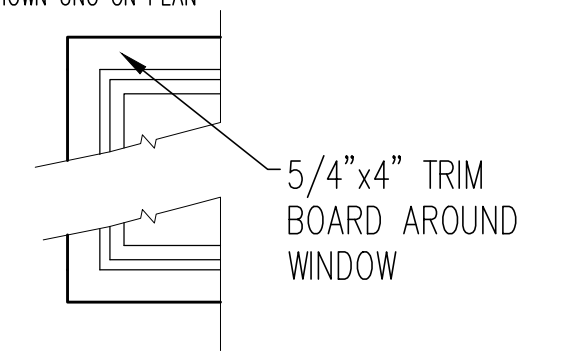

### WINDOW ELEVATION: WRAP

SCALE: 1/2" = 1'-0"

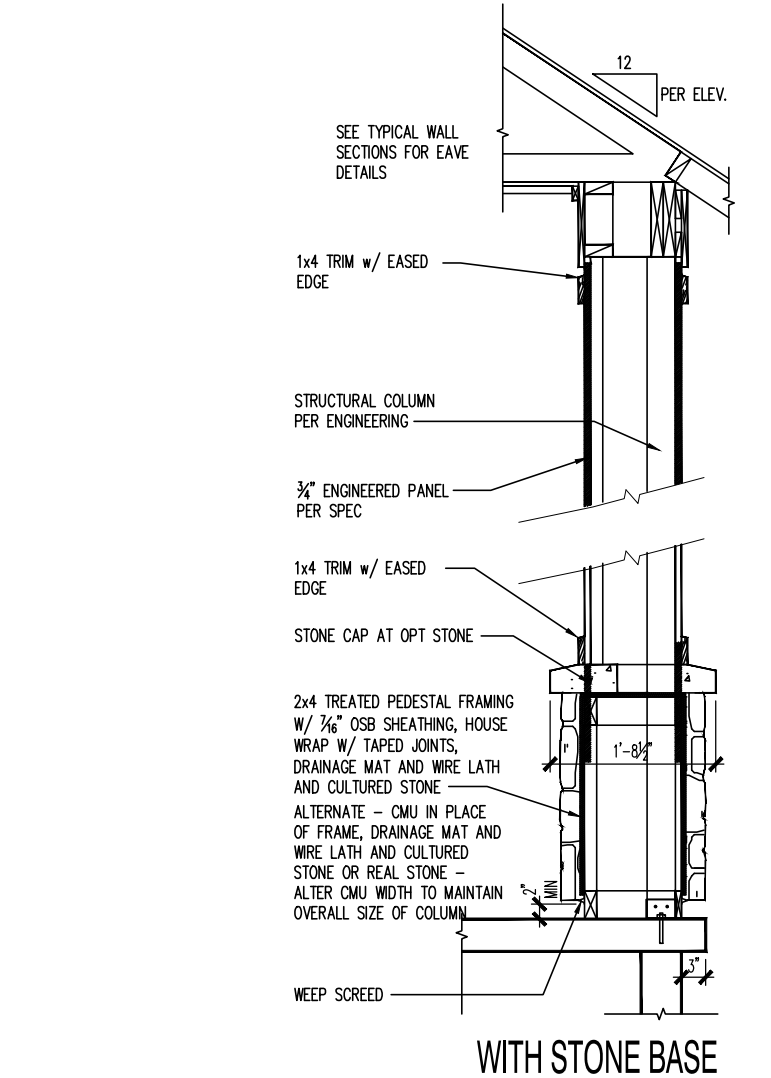
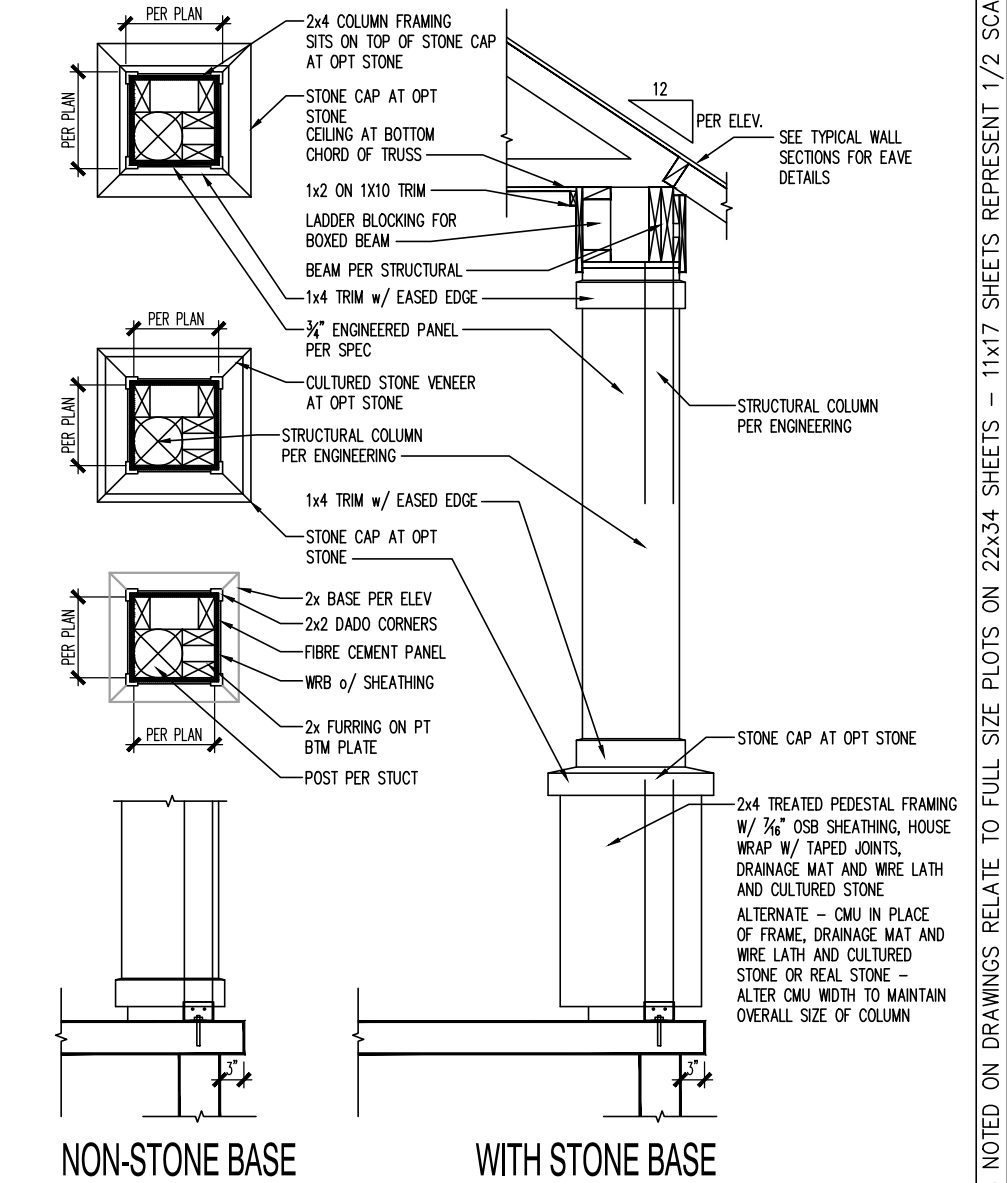

### PANEL COLUMN & STONE BASE

SCALE: 1/2" = 1'-0"

### ELEVATION C

Seattle Division  
3535 Factoria Blvd SE  
Bellevue, Washington 98006



Exterior Elevations  
Optional Elevation

REV #	DATE	DESCRIPTION

PRODUCTION MANAGER Josh DeVoll CURRENT RELEASE DATE: /-/
PROJECT TYPE Single Family
COMMUNITY NAME Frog Pond Crossing 4000 Series LAWSON COMMUNITY ID 8305
GARAGE HANDING Left
SPECIFICATION LEVEL Pulte
PLAN NAME Lynwood NPS PLAN NUMBER 2374.401 LAWSON PLAN ID 40333 LEGACY PLAN NUMBER / NAME 4033-3

SHEET  
A2.20



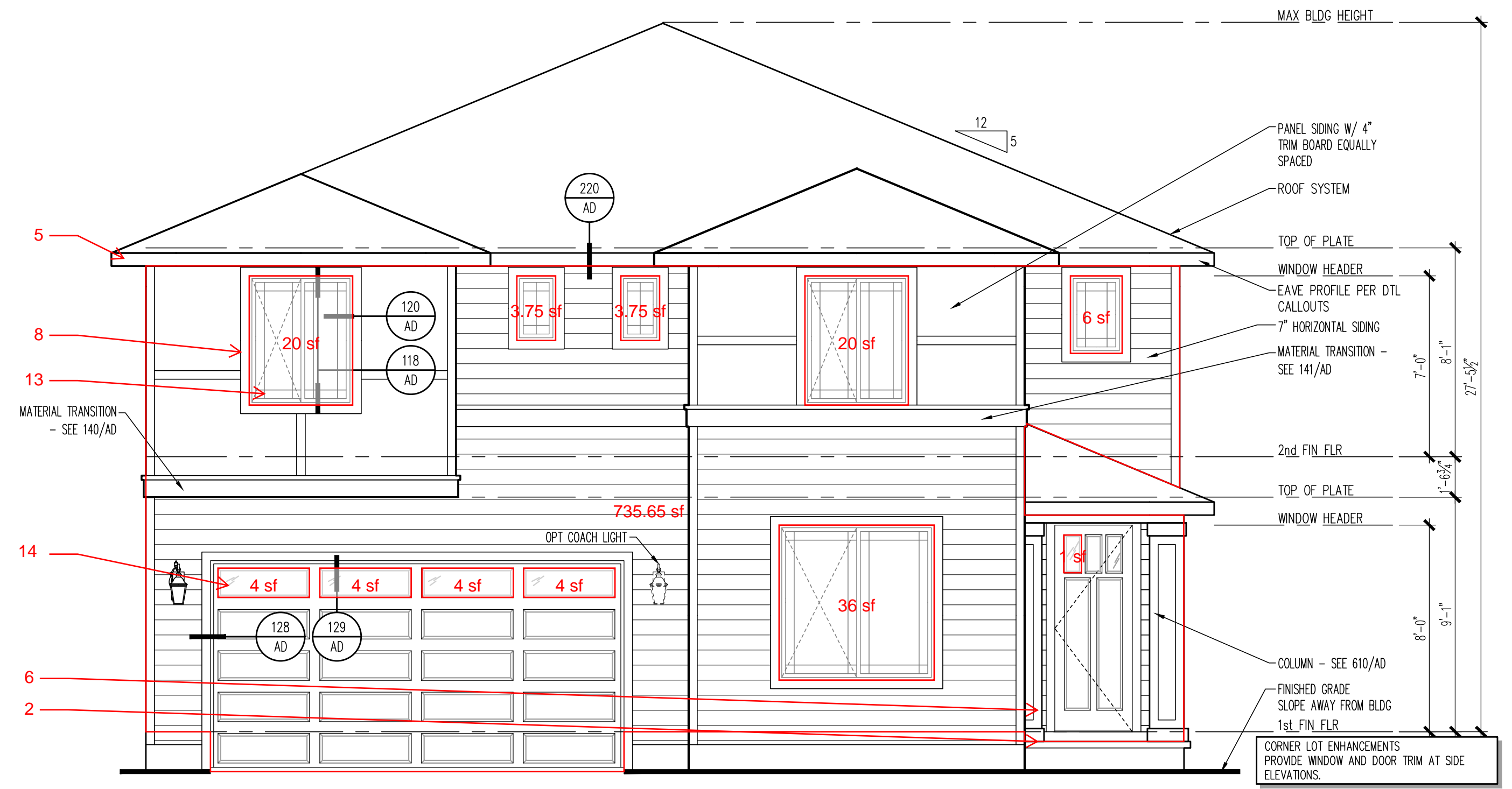

FRONT ELEVATION 'C'  
SCALE: 1/4" = 1'-0"

**Residential Design Menu:** Residential structures shall provide a minimum of five of the design elements listed below for front facades and facades facing Backman Road and Stafford Road, unless otherwise specified by the code. For side facades facing streets, pedestrian connections, parks, open space tracts, a minimum of three of the design elements must be provided, where a design feature.

1. **Dimensions at least three feet wide**
2. **Covered porch entry** - minimum 48 square foot covered front porch, minimum six feet deep and minimum of a six foot deep cover. A covered front stoop with minimum 24 square foot area, four foot depth and hand rails meets this standard.
3. Front porch railing around at least two sides of the porch.
4. Front facing second story balcony - projecting from the wall of the building a minimum of four feet and enclosed by a railing or parapet wall.
5. **Roof overhang of 16 inches or greater**
6. **Columns, pilasters or posts at least four inches wide and containing larger base materials**
7. **Decorative gables** - cross or diagonal bracing, shingles, trim, corbels, exposed rafter ends or brackets (does not include a garage gable if garage projects beyond dwelling unit portion of street facade).
8. **Decorative masonry above windows and doors**
9. **Decorative plaster or chimney**
10. **Shingles, shingles, brick, stone or other similar decorative materials** occupying at least 60 square feet of the street facade.
11. **Bay or bow windows** - extending a minimum of 12 inches outward from the main wall of a building and forming a bay or alcove in a room within the building.
12. **Sidelight and/or transom windows associated with the front door or windows in the front door**
13. **Window grids on all facade windows** (excluding any windows in the garage door or front door).
14. **Maximum nine foot wide garage doors or a garage door designed to resemble two smaller garage doors and/or windows in the garage door** (only applicable to street facing garages).
15. **Decorative level materials** such as exterior stone, cultured stone or brick occupying at least 36 inches above finished grade occupying a minimum of ten percent of the overall primary street facing facade.
16. Entry courtyards which are visible from, and connected directly to, the street. Courtyards shall have a minimum depth of ten feet and minimum width of 60 percent of the non-garage/driveway building width to be counted as a design element.

$$20 + 3.75 + 3.75 + 20 + 6 + 4 + 4 + 4 + 4 + 36 + 1 + 1 + 1 = 108.5 / 735.65 = 14.7\%$$

**C. Windows.** The standards for minimum percentage of facade surface area in windows are below. These standards apply only to facades facing streets, pedestrian connections, parks, and open space tracts.

1. For two-story structures:
  - a. 15 percent front facades.
  - b. 12.5 percent—front facades if a minimum of six design elements are provided per [Section 4.127\(0.15\)E](#), Design Menu.
  - c. Ten percent—front facades facing streets if a minimum of seven design elements are provided per [Section 4.127\(0.15\)E](#), Design Menu.
2. For one-story structures:
  - a. 12.5 percent—front facades.
  - b. Ten percent—front facades if a minimum of six design elements are provided per [Section 4.127\(0.15\)E](#), Design Menu.
3. For all structures: Five percent for street-side facades.
4. Windows used to meet this standard must provide views from the building to the street. Glass block does not meet this standard. Windows in garage doors and other doors count toward

(c) Copyright PulteGroup, Inc. - 2022

Seattle Division  
3535 Factoria Blvd SE  
Bellevue, Washington 98006



Exterior Elevations  
Optional Elevation

PRODUCTION MANAGER	REVISION	DATE / DESCRIPTION
Josh DeVoll		
CURRENT RELEASE DATE: /-/-		
REV #	DATE	DESCRIPTION
1		
2		
3		
4		
5		
6		
7		
8		
9		
10		

PROJECT TYPE  
Single Family

COMMUNITY NAME  
Frog Pond Crossing  
4000 Series  
LAWSON COMMUNITY ID  
8305

GARAGE HANDING  
Left

SPECIFICATION LEVEL  
Pulte

PLAN NAME  
Lynwood  
NPS PLAN NUMBER  
2374.401  
LAWSON PLAN ID  
40333  
LEGACY PLAN NUMBER / NAME  
4033-3

SHEET  
A2.20

ELEVATION C



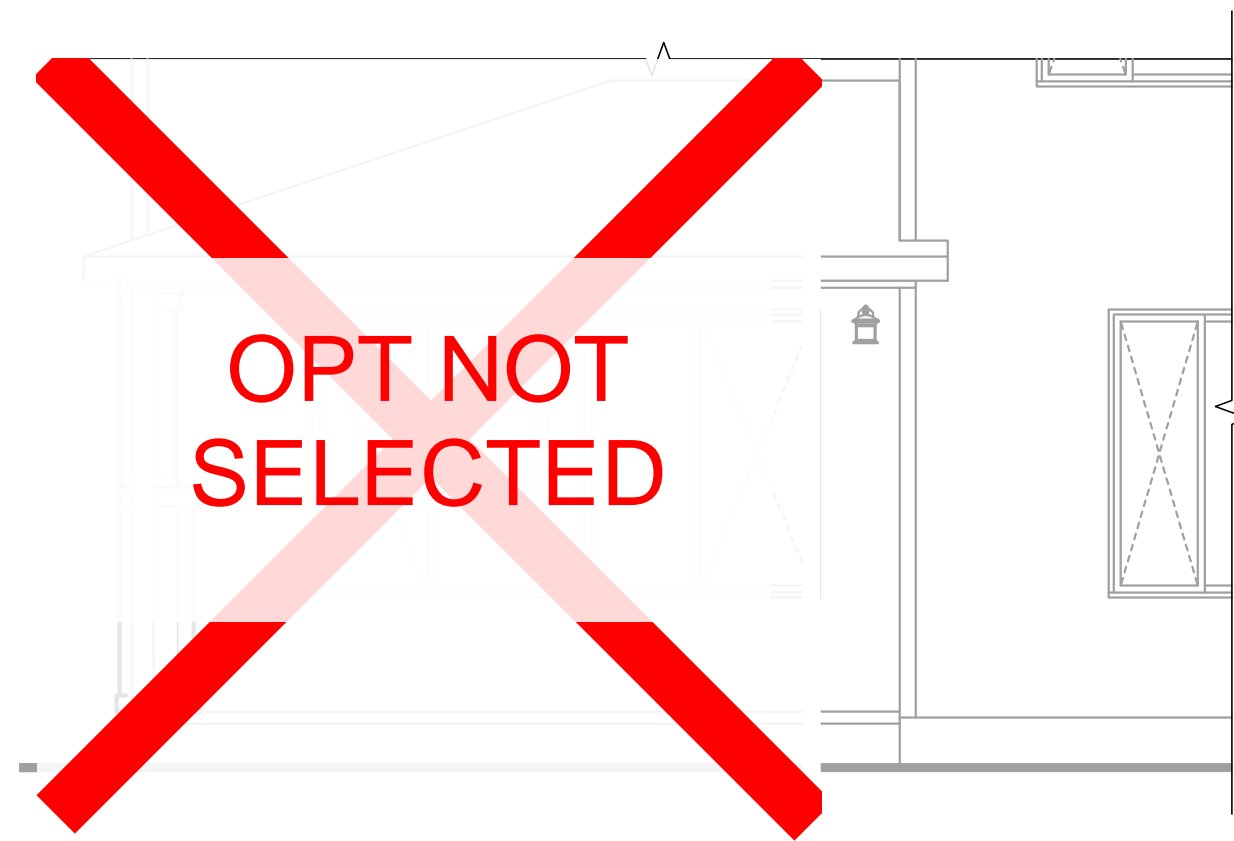

REAR ELEVATION - EXTERIOR FIREPLACE 2

SCALE: 1/4" = 1'-0"

OPT 70840

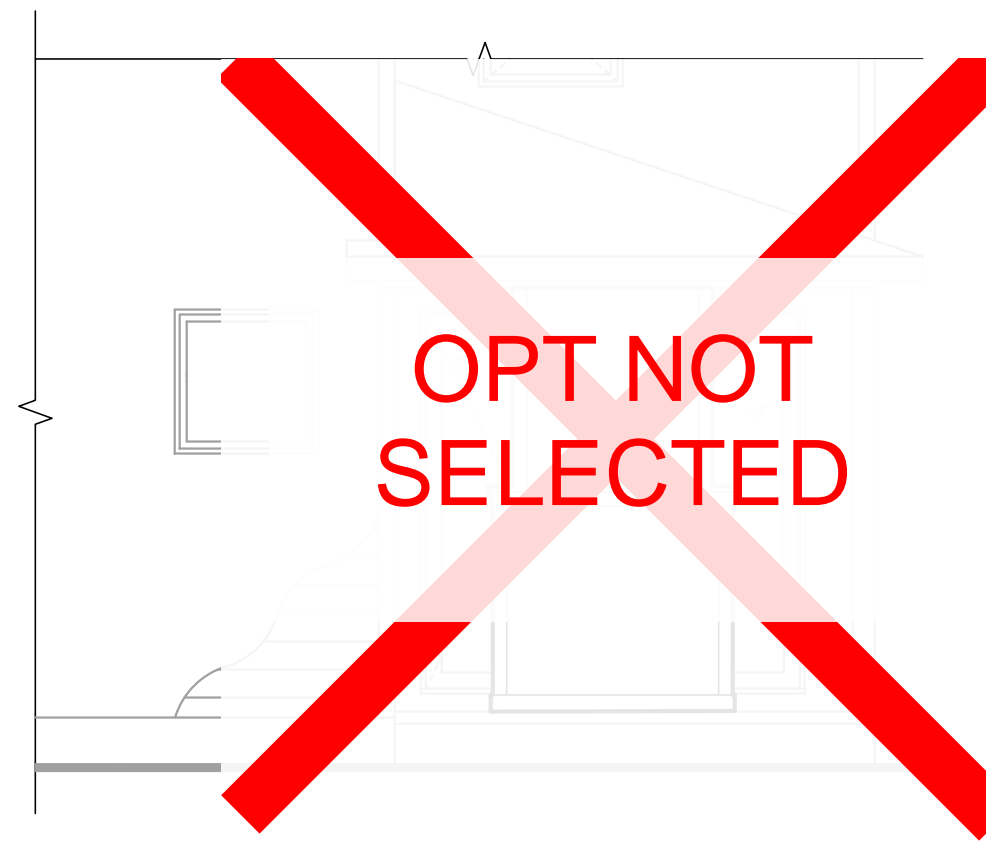

RIGHT ELEVATION - EXTERIOR FIREPLACE 2

SCALE: 1/4" = 1'-0"

OPT 70840

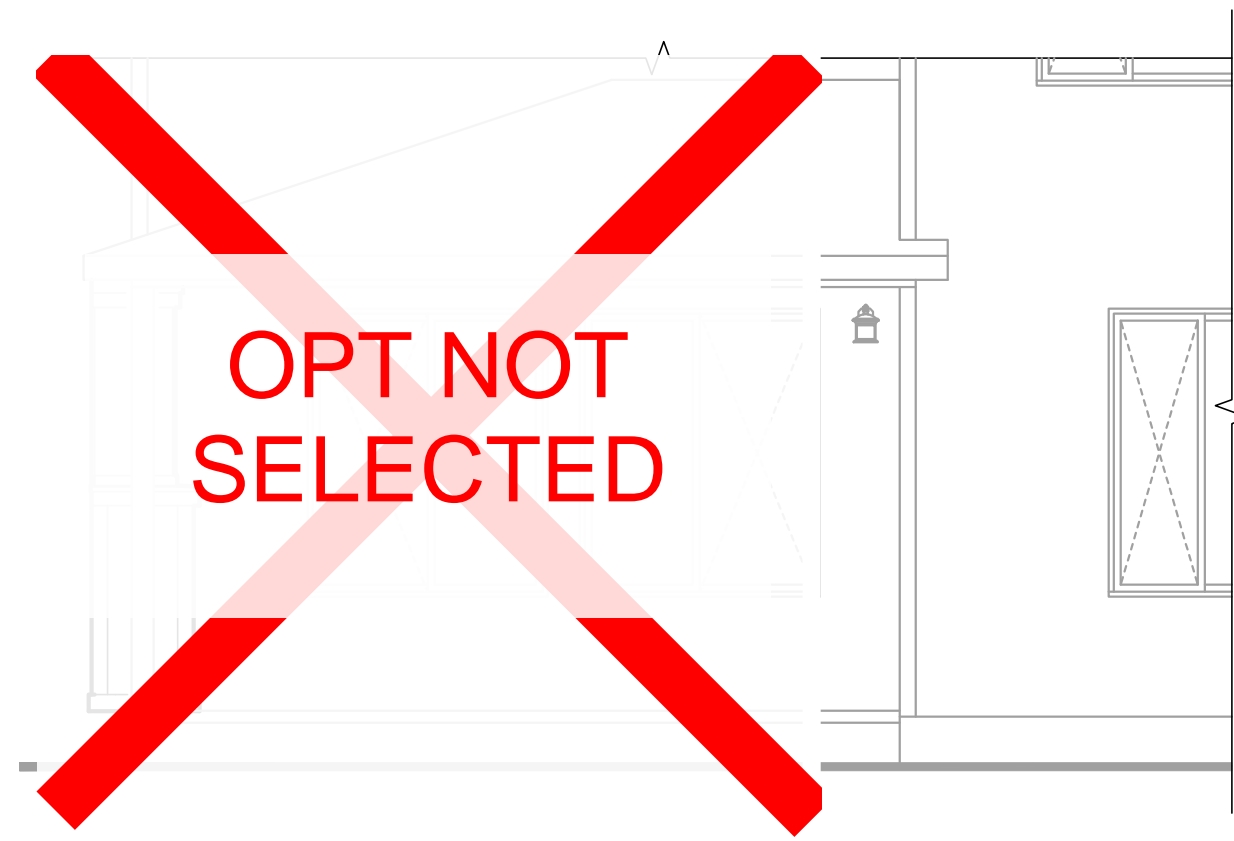

REAR ELEVATION - EXTERIOR FIREPLACE

SCALE: 1/4" = 1'-0"

OPT 70838

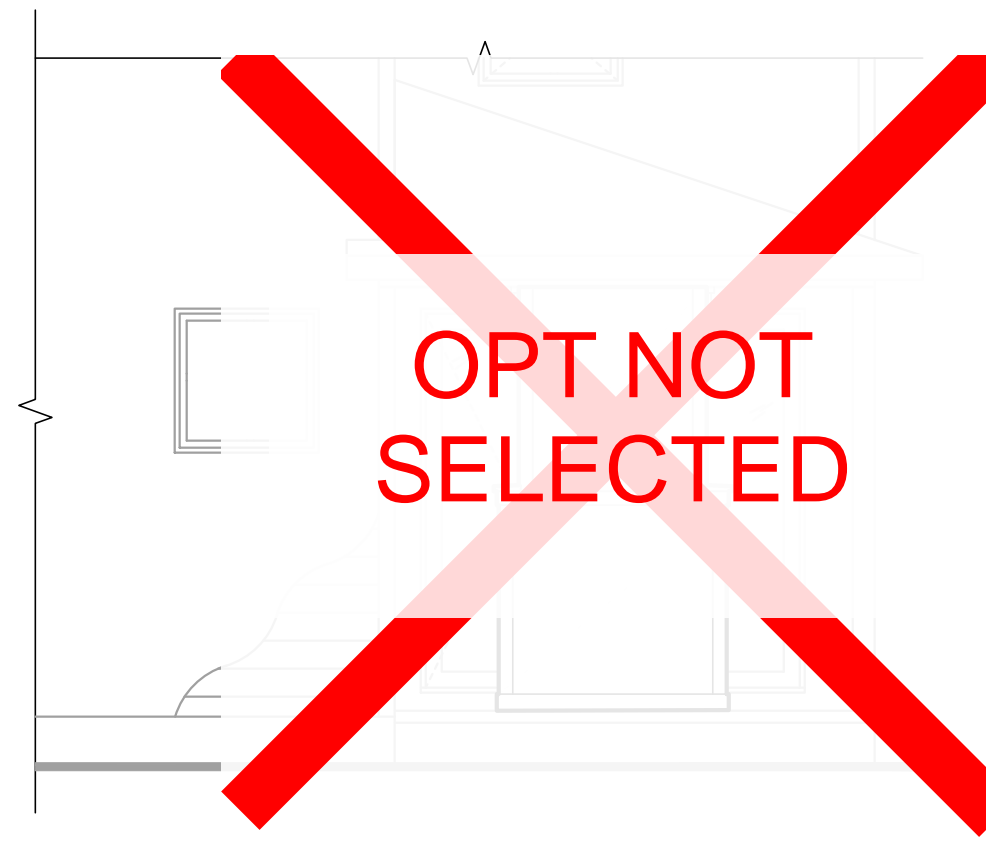

RIGHT ELEVATION - EXTERIOR FIREPLACE

SCALE: 1/4" = 1'-0"

OPT 70838

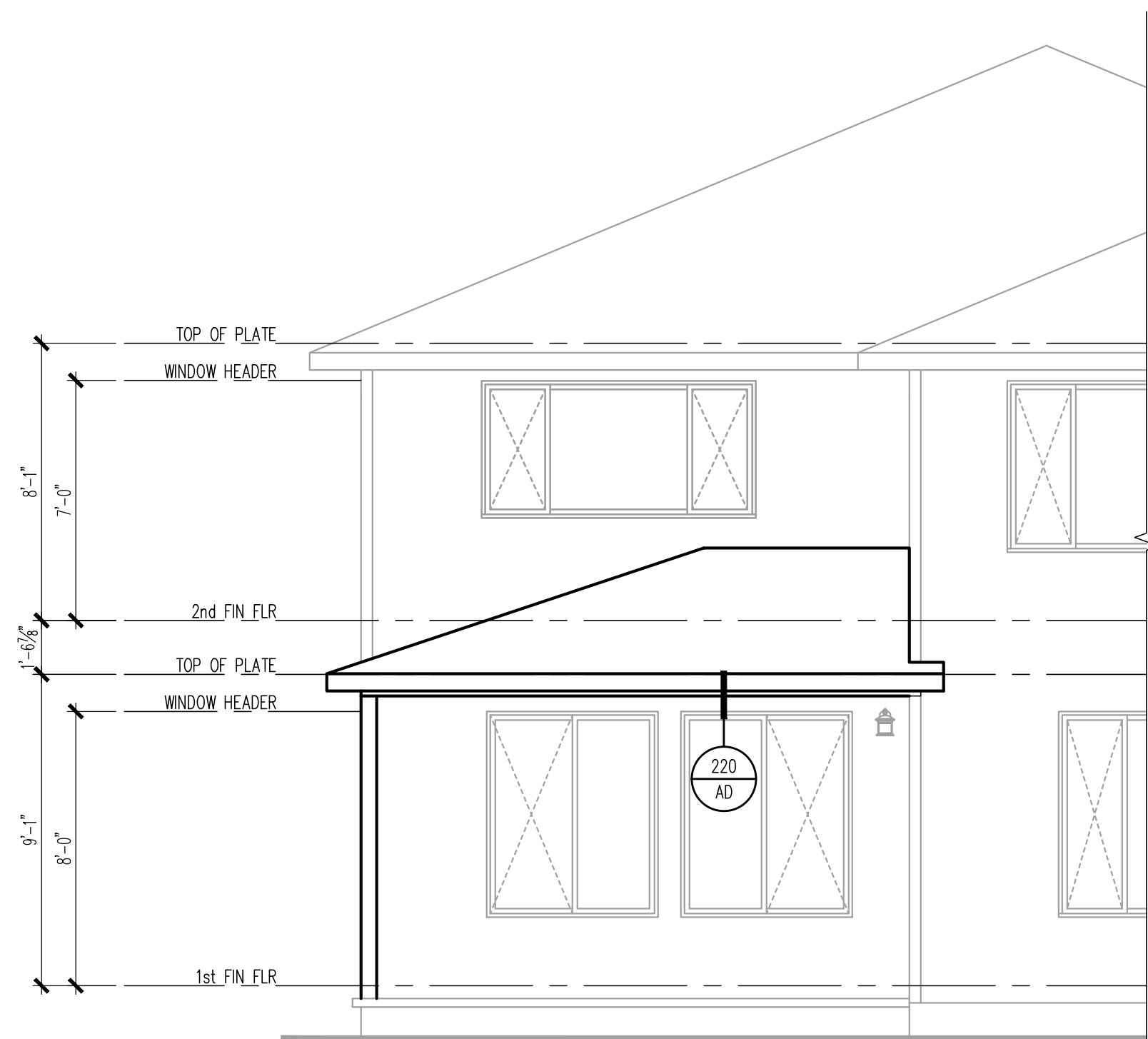

REAR ELEVATION - COVERED PATIO

SCALE: 1/4" = 1'-0"

OPT 70300

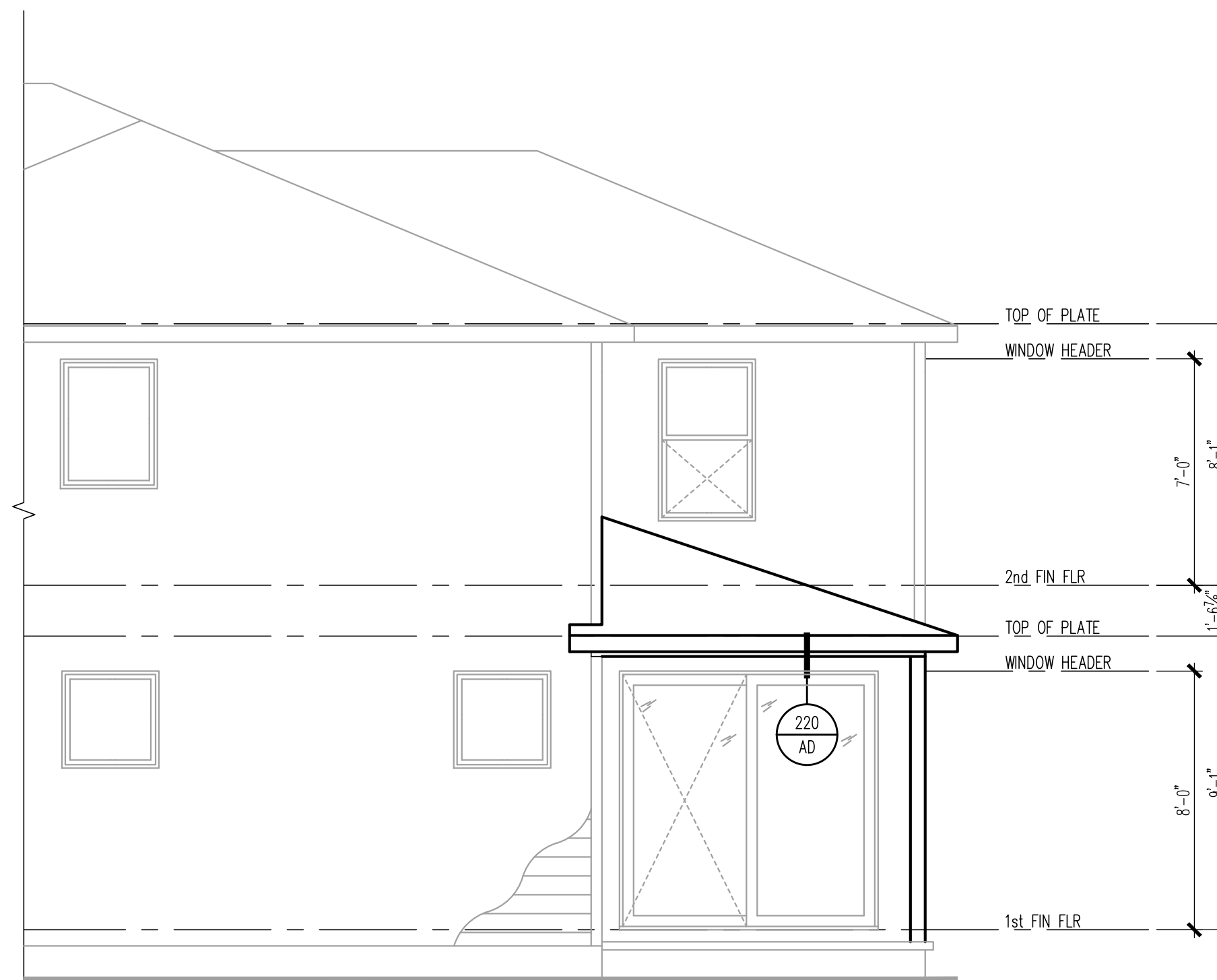

RIGHT ELEVATION - COVERED PATIO

SCALE: 1/4" = 1'-0"

OPT 70300

REV #	DATE	DESCRIPTION

PRODUCTION MANAGER Josh DeVoll
CURRENT RELEASE DATE: /-/-
PROJECT TYPE Single Family
COMMUNITY NAME Frog Pond Crossing 4000 Series
LAWSON COMMUNITY ID 8305
GARAGE HANDING Left
SPECIFICATION LEVEL Pulte
PLAN NAME Lynwood
NR PLAN NUMBER 2374.401
LAWSON PLAN ID 40333
LEGACY PLAN NUMBER / NAME 4033-3



# Engineering Conditions and Requirements for Proposed Development

**From:** Amy Pepper, PE Development Engineering Manager

**To:** Sarah Pearlman, Assistant Planner

**Date:** February 10, 2023

**Proposal:** Frog Pond Crossing temporary use sales trailer and model home

## Engineering Division Conditions:

Request: DB22-0013 Preliminary Development Plan

<b>PFA 1.</b>	Public Works Plans and Public Improvements shall conform to the “Public Works Plan Submittal Requirements and Other Engineering Requirements” in Exhibit C1 and to specifics as found in the Frog Pond West Mater Plan (July 17, 2017).
<b>PFA 2.</b>	<b><u>Prior to Issuance of Building Permit:</u></b> Submit a site plan showing all utility connections and street improvements including pavement, curb, planter strip, street trees, sidewalk, and driveway approaches along the sites frontage on Windflower Street. Street improvements shall be constructed in accordance with the Public Works Standards.
<b>PFA 3.</b>	<b><u>Prior to Issuance of Building Permit:</u></b> A final stormwater report shall be submitted for review and approval. The stormwater report shall include information and calculations to demonstrate how the proposed development meets the treatment and flow control requirements. The stormwater report shall also include conveyance calculations to demonstrate that any downstream impacts can be mitigated.
<b>PFA 4.</b>	<b><u>Prior to the Issuance of the Building Permit:</u></b> Submit plan showing construction parking for contractors. All construction related parking must be within the Frog Pond Crossing subdivision boundaries.
<b>PFA 5.</b>	<b><u>Prior to the Issuance of the Building Permit:</u></b> All public improvements (water, sewer and storm) must be complete and ready for connection. Alternatively, the City may allow construction to commence prior to utilities being available if a temporary alternative solution is approved by the City.
<b>PFA 6.</b>	<b><u>Prior to Any Paving:</u></b> Downstream stormwater facilities must be constructed and planted. <b><u>Prior to Engineering Final:</u></b> The applicant must execute and record with the County a Stormwater Maintenance Agreement with the City.



Exhibit C1  
Public Works Plan Submittal Requirements  
and Other Engineering Requirements

---

1. All construction or improvements to public works facilities shall be in conformance to the City of Wilsonville Public Works Standards - 2017.
2. Applicant shall submit insurance requirements to the City of Wilsonville in the following amounts:

<b>Coverage</b> ( <i>Aggregate, accept where noted</i> )	<b>Limit</b>
<b><u>Commercial General Liability:</u></b>	
▪ General Aggregate (per project)	\$3,000,000
▪ General Aggregate (per occurrence)	\$2,000,000
▪ Fire Damage (any one fire)	\$50,000
▪ Medical Expense (any one person)	\$10,000
<b><u>Business Automobile Liability Insurance:</u></b>	
▪ Each Occurrence	\$1,000,000
▪ Aggregate	\$2,000,000
<b><u>Workers Compensation Insurance</u></b>	\$500,000

3. No construction of, or connection to, any existing or proposed public utility/improvements will be permitted until all plans are approved by Staff, all fees have been paid, all necessary permits, right-of-way and easements have been obtained and Staff is notified a minimum of 24 hours in advance.
4. All public utility/improvement plans submitted for review shall be based upon a 22" x 34" format and shall be prepared in accordance with the City of Wilsonville Public Work's Standards.
5. Plans submitted for review shall meet the following general criteria:
  - a. Utility improvements that shall be maintained by the public and are not contained within a public right-of-way shall be provided a maintenance access acceptable to the City. The public utility improvements shall be centered in a minimum 15-ft. wide public easement for single utilities and a minimum 20-ft wide public easement for two parallel utilities and shall be conveyed to the City on its dedication forms.
  - b. Design of any public utility improvements shall be approved at the time of the issuance of a Public Works Permit. Private utility improvements are subject to review and approval by the City Building Department.
  - c. In the plan set for the PW Permit, existing utilities and features, and proposed new private utilities shall be shown in a lighter, grey print. Proposed public improvements shall be shown in bolder, black print.

- d. All elevations on design plans and record drawings shall be based on NAVD 88 Datum.
  - e. All proposed on and off-site public/private utility improvements shall comply with the State of Oregon and the City of Wilsonville requirements and any other applicable codes.
  - f. Design plans shall identify locations for street lighting, gas service, power lines, telephone poles, cable television, mailboxes and any other public or private utility within the general construction area.
  - g. As per City of Wilsonville Ordinance No. 615, all new gas, telephone, cable, fiber-optic and electric improvements etc. shall be installed underground. Existing overhead utilities shall be undergrounded wherever reasonably possible.
  - h. Any final site landscaping and signing shall not impede any proposed or existing driveway or interior maneuvering sight distance.
  - i. Erosion Control Plan that conforms to City of Wilsonville Ordinance No. 482.
  - j. Existing/proposed right-of-way, easements and adjacent driveways shall be identified.
  - k. All engineering plans shall be printed to PDF, combined to a single file, stamped and digitally signed by a Professional Engineer registered in the State of Oregon.
  - l. All plans submitted for review shall be in sets of a digitally signed PDF and three printed sets.
6. Submit plans in the following general format and order for all public works construction to be maintained by the City:
- a. Cover sheet
  - b. City of Wilsonville construction note sheet
  - c. General construction note sheet
  - d. Existing conditions plan.
  - e. Erosion control and tree protection plan.
  - f. Site plan. Include property line boundaries, water quality pond boundaries, sidewalk improvements, right-of-way (existing/proposed), easements (existing/proposed), and sidewalk and road connections to adjoining properties.
  - g. Grading plan, with 1-foot contours.
  - h. Composite utility plan; identify storm, sanitary, and water lines; identify storm and sanitary manholes.
  - i. Detailed plans; show plan view and either profile view or provide i.e.'s at all utility crossings; include laterals in profile view or provide table with i.e.'s at crossings; vertical scale 1"= 5', horizontal scale 1"= 20' or 1"= 30'.
  - j. Street plans.
  - k. Storm sewer/drainage plans; number all lines, manholes, catch basins, and cleanouts for easier reference.
  - l. Stormwater LIDA facilities (Low Impact Development): provide plan and profile views of all LIDA facilities.
  - m. Water and sanitary sewer plans; plan; number all lines, manholes, and cleanouts for easier reference.

- n. Where depth of water mains are designed deeper than the 3-foot minimum (to clear other pipe lines or obstructions), the design engineer shall add the required depth information to the plan sheets.
  - o. Detailed plan for storm water detention facility (both plan and profile views), including water quality orifice diameter and manhole rim elevations. Provide detail of inlet structure and energy dissipation device. Provide details of drain inlets, structures, and piping for outfall structure. Note that although storm water detention facilities are typically privately maintained they will be inspected by engineering, and the plans must be part of the Public Works Permit set.
  - p. Detailed plan for water quality facility (both plan and profile views). Note that although storm water quality facilities are typically privately maintained they will be inspected by Natural Resources, and the plans must be part of the Public Works Permit set.
  - q. Composite franchise utility plan.
  - r. City of Wilsonville detail drawings.
  - s. Illumination plan.
  - t. Striping and signage plan.
  - u. Landscape plan.
7. Design engineer shall coordinate with the City in numbering the sanitary and stormwater sewer systems to reflect the City's numbering system. Video testing and sanitary manhole testing will refer to City's numbering system.
  8. The applicant shall install, operate and maintain adequate erosion control measures in conformance with the standards adopted by the City of Wilsonville Ordinance No. 482 during the construction of any public/private utility and building improvements until such time as approved permanent vegetative materials have been installed.
  9. Applicant shall work with City Engineering before disturbing any soil on the respective site. If 5 or more acres of the site will be disturbed applicant shall obtain a 1200-C permit from the Oregon Department of Environmental Quality. If 1 to less than 5 acres of the site will be disturbed a 1200-CN permit from the City of Wilsonville is required.
  10. The applicant shall be in conformance with all stormwater and flow control requirements for the proposed development per the Public Works Standards.
  11. A storm water analysis prepared by a Professional Engineer registered in the State of Oregon shall be submitted for review and approval by the City.
  12. The applicant shall be in conformance with all water quality requirements for the proposed development per the Public Works Standards. If a mechanical water quality system is used, prior to City acceptance of the project the applicant shall provide a letter from the system manufacturer stating that the system was installed per specifications and is functioning as designed.

13. Storm water quality facilities shall have approved landscape planted and/or some other erosion control method installed and approved by the City of Wilsonville prior to streets and/or alleys being paved.
14. The applicant shall contact the Oregon Water Resources Department and inform them of any existing wells located on the subject site. Any existing well shall be limited to irrigation purposes only. Proper separation, in conformance with applicable State standards, shall be maintained between irrigation systems, public water systems, and public sanitary systems. Should the project abandon any existing wells, they shall be properly abandoned in conformance with State standards.
15. All survey monuments on the subject site, or that may be subject to disturbance within the construction area, or the construction of any off-site improvements shall be adequately referenced and protected prior to commencement of any construction activity. If the survey monuments are disturbed, moved, relocated or destroyed as a result of any construction, the project shall, at its cost, retain the services of a registered professional land surveyor in the State of Oregon to restore the monument to its original condition and file the necessary surveys as required by Oregon State law. A copy of any recorded survey shall be submitted to Staff.
16. Streetlights shall be in compliance with City dark sky, LED, and PGE Option C requirements.
17. Sidewalks, crosswalks and pedestrian linkages in the public right-of-way shall be in compliance with the requirements of the U.S. Access Board.
18. No surcharging of sanitary or storm water manholes is allowed.
19. The project shall connect to an existing manhole or install a manhole at each connection point to the public storm system and sanitary sewer system.
20. A City approved energy dissipation device shall be installed at all proposed storm system outfalls. Storm outfall facilities shall be designed and constructed in conformance with the Public Works Standards.
21. The applicant shall provide a 'stamped' engineering plan and supporting information that shows the proposed street light locations meet the appropriate AASHTO lighting standards for all proposed streets and pedestrian alleyways.
22. All required pavement markings, in conformance with the Transportation Systems Plan and the Bike and Pedestrian Master Plan, shall be completed in conjunction with any conditioned street improvements.
23. Street and traffic signs shall have a hi-intensity prismatic finish meeting ASTM 4956 Spec Type 4 standards.



24. The applicant shall provide adequate sight distance at all project driveways by driveway placement or vegetation control. Specific designs to be submitted and approved by the City Engineer. Coordinate and align proposed driveways with driveways on the opposite side of the proposed project site.
25. The applicant shall provide adequate sight distance at all project street intersections, alley intersections and commercial driveways by properly designing intersection alignments, establishing set-backs, driveway placement and/or vegetation control. Coordinate and align proposed streets, alleys and commercial driveways with existing streets, alleys and commercial driveways located on the opposite side of the proposed project site existing roadways. Specific designs shall be approved by a Professional Engineer registered in the State of Oregon. As part of project acceptance by the City the Applicant shall have the sight distance at all project intersections, alley intersections and commercial driveways verified and approved by a Professional Engineer registered in the State of Oregon, with the approval(s) submitted to the City (on City approved forms).
26. Access requirements, including sight distance, shall conform to the City's Transportation Systems Plan (TSP) or as approved by the City Engineer. Landscaping plantings shall be low enough to provide adequate sight distance at all street intersections and alley/street intersections.
27. Applicant shall design interior streets and alleys to meet specifications of Tualatin Valley Fire & Rescue and Allied Waste Management (United Disposal) for access and use of their vehicles.
28. The applicant shall provide the City with a Stormwater Maintenance and Access Easement Agreement (on City approved forms) for City inspection of those portions of the storm system to be privately maintained. Applicant shall provide City with a map exhibit showing the location of all stormwater facilities which will be maintained by the Applicant or designee. Stormwater or rainwater LID facilities may be located within the public right-of-way upon approval of the City Engineer. Applicant shall maintain all LID storm water components and private conventional storm water facilities; maintenance shall transfer to the respective homeowners association when it is formed.
29. The applicant shall "loop" proposed waterlines by connecting to the existing City waterlines where applicable.
30. Applicant shall provide a minimum 6-foot Public Utility Easement on lot frontages to all public right-of-ways. An 8-foot PUE shall be provided along Collectors. A 10-ft PUE shall be provided along Minor and Major Arterials.
31. For any new public easements created with the project the Applicant shall be required to produce the specific survey exhibits establishing the easement and shall provide the City with the appropriate Easement document (on City approved forms).

32. Mylar Record Drawings:

At the completion of the installation of any required public improvements, and before a 'punch list' inspection is scheduled, the Engineer shall perform a record survey. Said survey shall be the basis for the preparation of 'record drawings' which will serve as the physical record of those changes made to the plans and/or specifications, originally approved by Staff, that occurred during construction. Using the record survey as a guide, the appropriate changes will be made to the construction plans and/or specifications and a complete revised 'set' shall be submitted. The 'set' shall consist of drawings on 3 mil. Mylar and an electronic copy in AutoCAD, current version, and a digitally signed PDF.