

## Geotechnical Engineering Report

Parkway Woods Business Park – Parking and  
New Buildings  
26600 SW Parkway Avenue  
Wilsonville, Oregon

*for*

**ScanlanKemperBard, LLC**  
**c/o Atwell, LLC**

April 17, 2020



## **Geotechnical Engineering Report**

Parkway Woods Business Park – Parking and  
New Buildings  
26600 SW Parkway Avenue  
Wilsonville, Oregon

*for*

**ScanlanKemperBard, LLC**  
**c/o Atwell, LLC**

April 17, 2020



333 High Street NE, Suite 102  
Salem, Oregon 97301  
971.304.3078

**Geotechnical Engineering Report**  
**Parkway Woods Business Park – Parking and**  
**New Buildings**  
**26600 SW Parkway Avenue**  
**Wilsonville, Oregon**

**File No. 23754-001-01**

**April 17, 2020**

Prepared for:

SkatlanKemperBard, LLC  
c/o Atwell, Inc.  
9755 SW Barnes Road, Suite 150  
Portland, Oregon 97225

Attention: Brady Berry, PE

Prepared by:

GeoEngineers, Inc.  
333 High Street NE, Suite 102  
Salem, Oregon 97301  
971.304.3078

  
Benjamin J. Hoffman, PE  
Senior Geotechnical Engineer

  
Julio C. Vela, PhD, PE, GE  
Principal

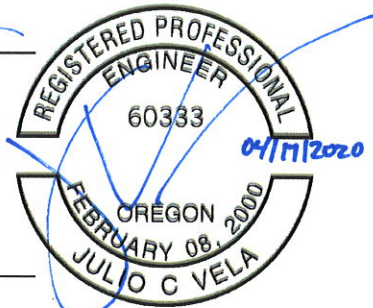

EXPIRES: 06/30/2020

BJH:JCV:cje

Disclaimer: Any electronic form, facsimile or hard copy of the original document (email, text, table, and/or figure), if provided, and any attachments are only a copy of the original document. The original document is stored by GeoEngineers, Inc. and will serve as the official document of record.

# Table of Contents

<b>1.0 INTRODUCTION</b>	<b>1</b>
<b>2.0 SCOPE OF SERVICES</b>	<b>1</b>
<b>3.0 SITE CONDITIONS</b>	<b>2</b>
3.1. Surface Conditions	2
3.2. Site Geology	3
3.3. Subsurface Conditions	3
3.3.1. General	3
3.3.2. Existing Pavement and Aggregate Base	4
3.4. Groundwater	4
<b>4.0 CONCLUSIONS</b>	<b>4</b>
4.1. General	4
<b>5.0 INFILTRATION TESTING</b>	<b>5</b>
5.1. Suitability of Infiltration System	7
<b>6.0 EARTHWORK RECOMMENDATIONS</b>	<b>7</b>
6.1. Site Preparation	7
6.1.1. General	7
6.1.2. Demolition	8
6.1.3. Stripping and Grubbing	8
6.2. Subgrade Preparation and Evaluation	8
6.3. Subgrade Protection and Wet Weather Considerations	9
6.4. Cement Treated Subgrade Design	10
6.5. Excavation	11
6.6. Dewatering	11
6.7. Trench Cuts and Trench Shoring	11
6.8. Erosion Control	12
6.9. Structural Fill and Backfill	12
6.9.1. General	12
6.9.2. On-Site Soils	12
6.9.3. Imported Select Structural Fill	13
6.9.4. Aggregate Base	13
6.9.5. Trench Backfill	13
6.10. Fill Placement and Compaction	13
6.11. Slopes	14
6.11.1. Permanent Slopes	14
6.11.2. Temporary Slopes	14
6.11.3. Slope Drainage	15
<b>7.0 STRUCTURAL DESIGN RECOMMENDATIONS</b>	<b>15</b>
7.1. Foundation Support Recommendations	15
7.1.1. Foundation Subgrade Preparation	16
7.1.2. Bearing Capacity – Spread Footings	16

7.1.3. Foundation Settlement.....	16
7.1.4. Lateral Resistance .....	17
7.2. Drainage Considerations .....	17
7.3. Floor Slabs.....	17
7.4. Seismic Design.....	18
7.4.1. Liquefaction Potential.....	19
<b>8.0 OTHER CONSIDERATIONS .....</b>	<b>19</b>
8.1. Frost Penetration .....	19
8.2. Expansive Soils .....	19
<b>9.0 PAVEMENT RECOMMENDATIONS .....</b>	<b>20</b>
9.1. Visual Pavement Surface Assessment .....	20
9.1.1. Entrance Drives.....	20
9.1.2. Parking Areas .....	21
9.2. Dynamic Cone Penetrometer (DCP) Testing.....	21
<b>10.0 PAVEMENT DESIGN &amp; RECOMMENDATIONS .....</b>	<b>22</b>
10.1.General .....	22
10.2.Traffic Loading .....	22
10.3.Input Parameters .....	22
10.3.1. Base Layer and Subgrade Resilient Moduli .....	22
10.3.2. AASHTO Input Parameters.....	23
10.3.3. Frost Design .....	23
10.4.Recommendations.....	23
10.4.1. General .....	23
10.4.2. New Pavement or Pavement Replacement Option.....	23
10.4.3. Overlay Option .....	24
<b>11.0 DESIGN REVIEW AND CONSTRUCTION SERVICES .....</b>	<b>24</b>
<b>12.0 LIMITATIONS .....</b>	<b>25</b>
<b>13.0 REFERENCES.....</b>	<b>25</b>

**LIST OF FIGURES**

Figure 1. Vicinity Map

Figure 2. Site Plan

**APPENDICES**

Appendix A. Field Explorations and Laboratory Testing

    Figure A-1. Key to Exploration Logs

    Figures A-2 through A-8. Logs of Borings

    Figures A-9 through A-13. Logs of Hand Augers

    Figures A-14 and A-15. Logs of Infiltration Testing

    Figures A-16 through A-21. Logs of Dynamic Cone Penetrometer Testing

Appendix B. Boring Logs for Previous Geotechnical Report for the Site

Appendix C. Report Limitations and Guidelines for Use

## 1.0 INTRODUCTION

GeoEngineers, Inc. (GeoEngineers), is pleased to submit this geotechnical engineering report for the proposed improvements for the Parkway Woods Business Park (Business Park) located at 26600 SW Parkway Avenue in Wilsonville, Oregon. Our understanding of the project is based on information provided to us by Mr. Brady Berry of Atwell, LLC, including a site plan showing proposed pavement rehabilitation areas, new paved parking areas and new building pad locations. The location of the site relative to the surrounding area is shown in the Vicinity Map, Figure 1.

Based on the information provided to us, we understand that the existing Parkway Woods Business Park is planning to build two new buildings (about 35,000 and 25,000 square-foot footprints – Pad A in the northwest portion of the site, and Pad B in the northeast portion of the site, respectively), construct new parking lots south and east of the existing building, and replace existing landscaping strips with new parking northwest of the existing building. The new buildings are each planned to be single-story commercial space of concrete tilt-up construction. New stormwater management facilities are planned as part of proposed site development.

At the time this report was prepared, specific building and pavement traffic loads were not provided. To develop the proposed scope, we have assumed typical structural loads consistent with this type of development. We have assumed that maximum column and wall loads will be on the order of 75 kips per column or less, and 4 kips per lineal foot (klf) or less respectively, and that floor loads for slabs on grade will be 125 pounds per square foot (psf) or less.

We prepared a geotechnical report for parking expansion and infiltration testing for the site dated January 28, 2019. Explorations conducted as a part of that geotechnical report are included in this report as Appendix B and exploration locations are noted in Figure 2 together with explorations conducted for this phase of work. Explorations included in the 2019 report are noted with a -19 extension in the Site Plan, Figure 2 and explorations conducted for this phase of work with a -20 extension.

## 2.0 SCOPE OF SERVICES

The purpose of our services for this phase of work was to evaluate on-site soil and groundwater conditions as a basis for providing development-specific geotechnical engineering design recommendations for the proposed project. Our proposed scope of services included the following:

1. Reviewed existing available subsurface soil and groundwater information, geologic maps and other available geotechnical engineering related information pertinent to the site.
2. Coordinated and managing the field investigation, including public utility notification and scheduling of subcontractors and GeoEngineers' field staff.
3. Explored subsurface soil and groundwater conditions at the site by drilling exploratory borings near the proposed improvements as follows:
  - a. Four drilled borings (B-1-20 through B-4-20) at proposed building locations.
  - b. Five hand-auger borings (HA-1-20 through HA-5-20) at proposed parking expansion areas.

- c. Three shallow pavement borings (cores) (C-1-20 through C-3-20) where dynamic cone penetrometer (DCP) tests were performed in existing paved parking areas.

Exploration locations are shown in Figure 2 together with exploration locations conducted as part of the previous geotechnical report. Logs of each exploration for this phase of work are provided in Appendix A. Exploration logs for the previous phase of work are provided in Appendix B for reference.

4. Conducted relatively shallow infiltration testing by means of downhole infiltration testing at five locations.
5. Obtained samples at representative intervals from the explorations, observed groundwater conditions and maintained detailed logs in general accordance with ASTM International (ASTM) Standard Practices Test Method D 2488. Qualified staff from our office observed and documented field activities.
6. Performed laboratory tests on selected soil samples obtained from the explorations to evaluate pertinent engineering characteristics. Laboratory test results are included on the exploration logs in Appendix A.
7. Provided a geotechnical engineering evaluation of the site and design recommendations in this report that address the following geotechnical engineering components:
  - a. A general description of site topography, geology and subsurface conditions.
  - b. An opinion as to the adequacy of site soil conditions for the proposed site development from a geotechnical engineering standpoint.
  - c. Measured infiltration rates for use by others in designing the stormwater infiltration system.
  - d. Recommendations for site preparation measures, including disposition of undocumented fill and unsuitable native soils and constraints for wet weather construction.
  - e. Recommendations for earthwork construction, including use of on-site and imported structural fill and fill placement and compaction requirements.
  - f. Trench backfill recommendations
  - g. Recommendations for constructing asphaltic concrete (AC) pavements for on-site parking, including subgrade, drainage, base rock and pavement section.
  - h. Recommendations for design and construction of spread foundations and slab-on-grade floors as well as providing allowable bearing pressures for isolated and continuous footings and parameters for resistance to lateral loads. In addition, providing estimates of post-construction settlement of building foundations.

Our geotechnical work has been directly supervised by a professional engineer licensed in the state of Oregon.

### **3.0 SITE CONDITIONS**

#### **3.1. Surface Conditions**

The proposed development areas are currently a mixture of undeveloped, grass-covered open landscaped areas or existing asphalt-paved parking lots. The landscape areas contain occasional to small stands of

semi-mature and mature oak and conifer trees. The site is generally level to gently undulating, with the majority of the site elevation ranging from approximately 225 feet above mean sea level (MSL) to 230 feet MSL. Site surface conditions are shown in Figure 2.

### **3.2. Site Geology**

Site geology is mapped by the *Geology and Geologic Hazards of Northwestern Clackamas County* (Schlicker and Finlayson 1979) as underlain by “lacustrine sediments” of Willamette Silt. Sedimentary deposits consist of late-stage “cross-bedded to graded” fine sandy silt and clay deposited by impoundment of the late Pleistocene glacial-outburst floods in the Willamette Valley.

Our subsurface explorations suggest that the site geology is consistent with the published mapping with the exception of minor veneer fills associated with development of the Parkway Woods complex.

### **3.3. Subsurface Conditions**

#### **3.3.1. General**

We completed on-site field explorations for this phase of work on March 30 and 31, 2020. Our explorations included four borings at the proposed building locations (B-1-20 through B-4-20) each advanced to a depth of 20 feet below ground surface (bgs), five hand augers in proposed pavement areas (HA-1-20 through HA-5-20) advanced to depths between 3½ and 7½ feet bgs, and three shallow pavement borings (cores) at existing paved areas (C-1-20 through C-3-20) each advanced to a depth of 6½ feet bgs. In addition, infiltration tests (IT-1-20 through IT-5-20) were performed at five locations with three of them at hand auger locations and at a depth of 3 to 4 feet bgs. DCP tests were performed at each of the pavement core locations. Approximate exploration locations are shown in Figure 2 with the extension -20 for explorations conducted for this phase, and -19 for explorations conducted for the previous phase. Appendix A summarizes our exploration methods and presents our exploration logs. Laboratory test results are provided in the exploration logs and described in Appendix A.

Field explorations performed at the project site as part of a previous phase of the project consisted of seven soil borings (B-1-19 through B-7-19) and one shallow pavement boring (core) (C-7-19), and infiltration tests (IT-1-19 through IT-3-19) performed at a depth of 3.7 to 6 feet bgs. Subsurface data from the previous phase of work were also used to develop the conclusions and recommendations presented in this report.

Project areas that are currently unpaved are generally surfaced with grass with a topsoil/rootzone approximately 3 to 5 inches thick. An existing pavement section consisting of between 2 to 3 inches of AC over between 8½ to approximately 24 inches of aggregate base was encountered at the ground surface in B-3-20 and B-4-20 as well as C-1-20 through C-3-20. Below the pavement in these borings/cores, and at the ground surface in the remaining explorations, we encountered soft to very stiff (predominantly medium stiff to stiff) Willamette Silt sediment with varying amounts of fine to medium sand to the maximum depth explored. Within the Willamette Silt unit, interbeds consisting of medium stiff to very stiff lean to fat clay and medium dense silty sand were encountered in some of the explorations. In borings B-3-20 and B-4-20 we encountered silty sand material from an approximate depth of 15 feet bgs to the bottom of the exploration.



### 3.3.2. Existing Pavement and Aggregate Base

The general pavement structure in currently paved areas consists of AC over medium dense to dense crushed rock aggregate base. We encountered approximately 2 to 3 inches of AC pavement, with 2 inches being the most common thickness. The appearance of the asphalt cores suggests that the AC was placed in a single lift.

Full depth cracks were observed penetrating the entire depth of four of the five pavement borings/cores drilled (B-3-20, B-4-20, C-1-20 and C-2-20). The core from C-3-20 was badly damaged during coring, likely as a result of the thin original pavement. Cracks in the existing pavement, including in the four core locations, had been patched (sealed) with a tar-like sealant material.

The underlying aggregate base generally consisted of poorly graded angular to subrounded gravel with silt and sand to silty gravel with sand. The thickness of the base aggregate section was extremely variable, ranging from approximately 4 inches at the C-1-20 location to almost 2 feet at B-4-20.

### 3.4. Groundwater

Groundwater was observed at a depth of approximately 7 to 9 feet bgs in several explorations, ranging from 7 feet bgs in B-3-20 and B-4-20, and HA-1-20 and HA-2-20, 8½ feet bgs in B-1-20, and 9 feet bgs in B-2-20. This depth is consistent with data from nearby publicly available well logs that note groundwater levels typically between 8 and 12 feet bgs. Groundwater should be expected to rise several feet during periods of extended rainfall as well as from capillary rise in the fine-grained soils.

Dewatering of trenches and excavations will be required when groundwater seepage and/or perched groundwater are encountered, or excavations extend in the groundwater. Groundwater may perch on underlying fine-grained layers. More intensive dewatering may be required if relatively deep excavations extend below groundwater and may be difficult to dewater with conventional sumps if sandy layers are encountered that could cause a “running soils” condition into excavations where sandy material flows into excavations with the seeping groundwater. For deep excavations or where running soils are encountered, dewatering from well points would be required.

Groundwater conditions at the site are expected to vary seasonally due to rainfall events and other factors not observed in our explorations. However, they will remain relatively shallow the majority of the year making for poor infiltration conditions (minimal capacity to infiltrate), during wet times of the year especially.

## 4.0 CONCLUSIONS

### 4.1. General

Based on our explorations, testing and analyses, it is our opinion that the site is suitable for the proposed project from a geotechnical standpoint, provided the recommendations in this report are included in design and construction. We offer the following summary of conclusions regarding geotechnical design at the site.

- Groundwater was observed in our borings at depths between approximately 7 and 9 feet bgs. If excavations extend into the groundwater, dewatering will be necessary. Dewatering in sandy soils below depth of groundwater may require dewatering from well points.

- Measured infiltration rates were generally less than 1 inch per hour (0.25 to 1 in/hr) in the Willamette Silts as summarized in Section 5.0 of this report. In general, soils with infiltration rates less than 2 in/hr are not well suited as the sole means of stormwater disposal for sites. In addition, relatively shallow groundwater levels limit the depth to which infiltration facilities can be extended.
- Typical infiltration facilities require at least 5 feet of separation between the base of the facility and the seasonal high groundwater level. That would limit infiltration facility depth to 2 to 4 feet bgs.
- On-site near-surface soils generally consist of medium stiff silt. The silt soils will become significantly disturbed from earthwork occurring during periods of wet weather, or when the moisture content of the soil is more than a few percentage points above optimum. Wet weather construction practices will be required unless earthwork occurs during the dry summer months (typically mid-July to mid-September).
- Proposed structures can be satisfactorily supported on continuous and isolated shallow foundations supported on the firm native soils, or on imported select structural fill that extends to the firm native soils.
- Based on proposed development, our foundation recommendations are based on maximum anticipated loads of 75 kips or less for columns, 4 klf or less for walls, and floor loads of 125 psf or less. Based on these design loads, we estimate total settlement to be less than 1 inch. If larger structural loads are anticipated, we should review and reassess the estimated settlement.
- Fill material encountered at subgrade elevation should be evaluated by GeoEngineers during construction. Soft fill or fill with significant debris or unsuitable material should be removed to native stiff or firmer material and replaced with compacted structural fill.
- Slabs-on-grade will be satisfactorily supported on medium dense native soils with a minimum 6-inch layer of compacted crushed rock base overlying approved subgrade or on structural fill over medium stiff native soils.
- Pavement design considered two options: (1) new pavement or pavement replacement; and (2) an overlay section. We did not consider a grind and inlay section as the relatively thin pavement section would likely be completely demolished by grinding efforts.
- Standard pavement sections prepared as described in this report will suitably support the estimated traffic loads provided the site subgrade is prepared as recommended.

## 5.0 INFILTRATION TESTING

As requested by the project team, we conducted infiltration tests on site to assist in evaluating the potential capacity of on-site soils for design of stormwater infiltration areas at three locations. Tests were performed in general accordance with the encased falling head methods outlined for Professional Method Infiltration testing in the Clackamas County Service District No. 1 (CCSD#1) Stormwater Standards – Appendix E. On-site testing was performed at depths between approximately 3 to 4 feet bgs. Each test location was pre-soaked over a 4-hour period by repeated addition of water into the embedded pipe when necessary.

After the saturation period, the hole was filled with clean water to at least 12 inches above the soil in the bottom of the boring. The drop-in water level was measured over a period of time after the soak period, and refilled to repeat the test a minimum of three times. In the case where the water level falls during the time-

measured testing, infiltration rates diminish as a result of less head from the water column in the test. Field test results are summarized in Table 1.

**TABLE 1. INFILTRATION RESULTS**

Infiltration Test No.	Depth (feet)	USCS Material Type	Soil Description	Field Measured Infiltration Rate <sup>1</sup> (inches/hour)
IT-1-20	4	ML	Yellow-brown silt	0.75
IT-2-20	4	ML	Light gray silt	0.25
IT-3-20	3	ML	Yellow-brown silt	0.25
IT-4-20	4	ML	Yellow-brown silt	1
IT-5-20	3	ML	Yellow-brown silt	0.35

Notes:

<sup>1</sup> Appropriate factors should be applied to the field-measured infiltration rate, based on the design methodology and specific system used.

USCS = Unified Soil Classification System

Infiltration rates shown in Table 1 represent a field-measured infiltration rate. This measurement represents a short-term testing rate, and factors of safety have not been applied for the type of infiltration system being considered, or for variability that may be present across large areas in the on-site soil. In our opinion, and consistent with the state of the practice, correction factors should be applied to this measured rate to reflect the localized area of testing relative to the field sizes.

Appropriate correction factors should also be applied by the project civil engineer to account for long-term infiltration parameters. From a geotechnical perspective, we recommend a factor of safety (correction factor) of at least 2 be applied to the field infiltration values to account for potential soil variability with depth and location within the area tested. In addition, the stormwater system design engineer should determine and apply appropriate remaining correction factor values, or factors of safety, to account for repeated wetting and drying that occur in this area, degree of in-system filtration, frequency and type of system maintenance, vegetation, potential for siltation and bio-fouling, etc., as well as system design correction factors for overflow or redundancy, and base and facility size.

The actual depths, lateral extent and estimated infiltration rates can vary from the values presented above. Field testing/confirmation during construction is often required in large or long systems or other situations where soil conditions may vary within the area where the system is constructed. The results of this field testing might necessitate that the infiltration locations be modified to achieve the design infiltration rate.

The infiltration flow rate of a focused stormwater system, such as a drywell or small infiltration box or pond, typically diminishes over time as suspended solids and precipitates in the stormwater further clog the void spaces between the soil particles or cake on the infiltration surface or in the engineered media. The serviceable life of an infiltration media in a stormwater system can be extended by pre-filtering or with on-going accessible maintenance. Eventually, most systems will fail and will need to be replaced or have media regenerated or replaced.

Because of the very limited infiltration potential of the on-site soils with shallow groundwater conditions, we recommend that infiltration systems include an overflow that is connected to a suitable discharge point.

Also, infiltration systems can cause localized, high groundwater levels and should not be located near basement walls, retaining walls, or other embedded structures unless these are specifically designed to account for the resulting hydrostatic pressure. Infiltration locations should not be located on sloping ground, unless it is approved by a geotechnical engineer, and should not be infiltrated at a location that allows for flow to travel laterally toward a slope face, such as a mounded water condition or too close to a slope face that could cause instability of the slope.

### **5.1. Suitability of Infiltration System**

Successful design and implementation of stormwater infiltration systems and whether a system is suitable for a development depend on several site-specific factors. Stormwater infiltration systems are generally best suited for sites having sandy or gravelly soil with saturated hydraulic conductivities greater than 2 in/hr. That is not the case at this site. Sites with silty/clayey soil such as those encountered at this site, and sites with fine sand, silty sand, or gravel that has a high percentage of silt or clay in the matrix, or sites with relatively shallow underlying decomposed rock (residual soil), are generally not well suited for exclusive stormwater infiltration. Even soils that have fine-grained matrices are susceptible to volumetric change and softening during wetting and drying cycles. Fine-grained soils also have large variations in the magnitude of infiltration rates because of bedding and stratification that occurs during deposition and often has thin layers of less permeable or impermeable soil within a larger layer.

As discussed in Section 3.4 of this report, shallow groundwater was observed at 7 to 9 feet below the existing ground surface. Typical infiltration facilities require a minimum of 5 feet of separation between the facility base and the high groundwater level, which may be as shallow as 5 feet at this site during wet times of the year. Some jurisdictions require up to 10 feet of separation. This would limit the maximum depth of the facility to at least between 3 and 5 feet below the existing ground surface and that is only if 5 feet of separation or less is permitted.

As a result of fine-grained soil conditions, the relatively low measured infiltration rates, and the relatively shallow groundwater levels, we recommend infiltration of stormwater not be used as the sole method of stormwater management at this site unless those design factors can be otherwise accounted for by increasing infiltration area or coupling with other methods of stormwater disposal. Our recommendation is not intended to preclude the use of on-site infiltration, but to provide a framework for the limited capacity for long-term infiltration of any type of facility based on subsurface conditions observed during our exploration and testing.

## **6.0 EARTHWORK RECOMMENDATIONS**

### **6.1. Site Preparation**

#### **6.1.1. General**

In general, site preparation and earthwork for site development will include demolition and removal of existing structures and hardscapes, removal or relocation of existing site utilities where present beneath proposed buildings, excavation for removal of existing foundation elements, hardscape, tree and tree root removal, stripping and grubbing, grading the site and excavating for utilities and foundations. General site grading for building construction in the northwest corner will include removal of an existing 4- to 5-foot-high landscape berm. It is likely that soil placed to build the berm was not structural fill quality and/or not

compacted as structural fill and will require complete removal and haul off or use in landscape-only areas of proposed development.

### **6.1.2. Demolition**

All existing structural elements should be excavated out and removed from proposed structural areas. If present, existing utilities that will be abandoned on site should be identified prior to project construction. Abandoned utility lines larger than 4 inches in diameter that are located beneath proposed structural areas should be completely removed or filled with grout if abandoned and left in-place in order to reduce potential settlement or caving in the future.

Materials generated during demolition of existing improvements should be transported off site for disposal. Existing voids and new depressions created during site preparation, and resulting from removal of existing utilities or other subsurface elements, should be cleaned of loose soil or debris down to firm soil and backfilled with compacted structural fill. Disturbance to a greater depth should be expected if site preparation and earthwork are conducted during periods of wet weather.

### **6.1.3. Stripping and Grubbing**

Based on our observations at the site, we estimate that the depth of stripping of on-site organics in grass-covered areas will be on the order of about 3 to 5 inches. Greater stripping depths may be required to remove localized zones of loose or organic soil, and in areas where moderate to heavy vegetation may be present, or surface disturbance has occurred. In addition, if present in areas of proposed development, the primary root systems of trees should be completely removed. Stripped material should be transported off site for disposal or processed and used as fill in landscaping areas.

Where encountered, trees and their root balls should be grubbed to the depth of the roots, which could exceed 3 feet bgs. Depending on the methods used to remove the preceding material, considerable disturbance and loosening of the subgrade could occur. We recommend that disturbed soil be removed to expose stiff native soil. The resulting excavations should be backfilled with structural fill.

Extensive soil removal may be required at the existing 4- to 5-foot-high landscape berm on the west side of the site. It is a landscaped barrier to the roadway and interstate to the west and it is likely that soil placed to build the berm was not well compacted during placement, is not of structural fill quality, and may have been placed on unstripped or unimproved subgrade. The entire berm should be removed to expose native soils and exploratory test pits at the time of grading should be advanced to ensure that pre-existing upper soils, sod or organics have been completely removed at its base.

## **6.2. Subgrade Preparation and Evaluation**

Upon completion of site preparation activities, exposed subgrades should be proof-rolled with a fully loaded dump truck or similar heavy rubber-tired construction equipment where space allows to identify soft, loose or unsuitable areas. Probing may be used for evaluating smaller areas or where proof-rolling is not practical. Proof-rolling and probing should be conducted prior to placing fill, and should be performed by a representative of GeoEngineers who will evaluate the suitability of the subgrade and identify areas of yielding that are indicative of soft or loose soil. If soft or loose zones are identified during proof-rolling or probing, these areas should be excavated to the extent indicated by our representative and replaced with structural fill.

As discussed in Section 4.1 of this report, the native fine-grained, silty soil can be sensitive to small changes in moisture content and will be difficult, if not impossible, to compact adequately during wet weather. While tilling and compacting the subgrade is the economical method for subgrade improvement, it will likely only be possible during extended dry periods and following moisture conditioning of the soil.

During wet weather, or when the exposed subgrade is wet or unsuitable for proof-rolling, the prepared subgrade should be evaluated by observing excavation activity and probing with a steel foundation probe. Observations, probing, and compaction testing should be performed by a member of our staff. Wet soil that has been disturbed due to site preparation activities or soft or loose zones identified during probing should be removed and replaced with compacted structural fill.

### **6.3. Subgrade Protection and Wet Weather Considerations**

The upper fine-grained soils at the site are highly susceptible to moisture. Wet weather construction practices will be necessary if work is performed during periods of wet weather. If site grading will occur during wet weather conditions, it will be necessary to use track-mounted equipment, load material into trucks supported on gravel work pads and employ other methods to reduce ground disturbance. The contractor should be responsible to protect the subgrade during construction reflective of their proposed means and methods and time of year.

Earthwork planning should include considerations for minimizing subgrade disturbance. The following recommendations can be implemented if wet weather construction is considered:

- The ground surface in and around the work area should be sloped so that surface water is directed to a sump or discharge location. The ground surface should be graded such that areas of ponded water do not develop. Measures should be taken by the contractor to prevent surface water from collecting in excavations and trenches. Measures should be implemented to remove surface water from the work area.
- Earthwork activities should not take place during periods of heavy precipitation.
- Slopes with exposed soils should be covered with plastic sheeting or similar means.
- The site soils should not be left uncompacted and exposed to moisture. Sealing the surficial soils by rolling with a smooth-drum roller prior to periods of precipitation will reduce the extent to which these soils become wet or unstable.
- Construction activities should be scheduled so that the length of time that soils are left exposed to moisture is reduced to the extent practicable.
- Construction traffic should be restricted to specific areas of the site, preferably areas that are surfaced with working pad materials not susceptible to wet weather disturbance such as haul roads and rockered staging areas.
- When on-site fine-grained soils are wet of optimum, they are easily disturbed and will not provide adequate support for construction traffic or the proposed development. The use of granular haul roads and staging areas will be necessary for support of construction traffic. Generally, a 12- to 16-inch-thick mat of imported granular base rock aggregate material is sufficient for light staging areas for the building pad and light staging activities but is not expected to be adequate to support repeated heavy equipment or truck traffic. The granular mat for haul roads and areas with repeated heavy construction

traffic should be increased to between 18 and 24 inches. The actual thickness of haul roads and staging areas should be based on the contractor's approach to site development and the amount and type of construction traffic.

- During periods of wet weather, concrete should be placed as soon as practical after preparation of the footing excavations. Foundation bearing surfaces should not be exposed to standing water. If water collects in the excavation, it should be removed before placing structural fill or reinforcing steel. Subgrade protection for foundations consisting of a lean concrete mat may be necessary if footing excavations are exposed to extended wet weather conditions.
- The base rock (Aggregate Base and Aggregate Subbase) thicknesses described in Section 9.0 of this report is intended to support post-construction design traffic loads. The design base rock thicknesses will likely not support repeated heavy construction traffic during site construction, or during pavement construction. A thicker base rock section, as described above for haul roads, will likely be required to support construction traffic.

During wet weather, or when the exposed subgrade is wet or unsuitable for proof-rolling, the prepared subgrade should be evaluated by observing excavation activity and probing with a steel foundation probe. Observations, probing and compaction testing should be performed by a member of our staff. Wet soil that has been disturbed due to site preparation activities or soft or loose zones identified during probing should be removed and replaced with compacted structural fill.

#### **6.4. Cement Treated Subgrade Design**

Small project site areas may limit the implementation or use of cement treated subgrade. However, these recommendations are included as a potential alternative to the use of imported granular material for wet weather structural fill. An experienced contractor may be able to amend the on-site soil with portland cement to obtain suitable support properties. Successful use of soil amendment depends on the use of correct mixing techniques, soil moisture content and amendment quantities. Specific recommendations, based on exposed site conditions, for soil amending can be provided if necessary. However, for preliminary planning purposes, it may be assumed that a minimum of 5 percent cement (by dry weight, assuming a unit weight of 100 pounds per cubic foot [pcf]) will be sufficient for subgrade and general fill amendment. Treatment depths of 12 to 16 inches for roadway subgrades are typical (assuming a seven-day unconfined compressive strength of at least 80 pounds per square inch [psi]), though they may be adjusted in the field depending on site conditions. Soil amending should be conducted in accordance with the specifications provided in Oregon Structural Specialty Code 00344 (Treated Subgrade).

Portland cement-amended soil is hard and has low permeability; therefore, this soil does not drain well nor is it suitable for planting. Future landscape areas should not be cement amended, if practical, or accommodations should be planned for drainage and planting. Cement amendment should not be used if runoff during construction cannot be directed or drained away from areas that would be negatively affected by runoff from the amended surface, including adjacent building foundations, low-lying, wet areas or active waterways, and area drainage paths.

We recommend a target strength for cement-amended soils of 80 psi. The amount of cement used to achieve this target generally varies with moisture content and soil type. It is difficult to predict field performance of soil to cement amendment due to variability in soil response, and we recommend laboratory testing to confirm expectations. However, for preliminary design purposes, 4 to 5 percent cement by weight

of dry soil can generally be used when the soil moisture content does not exceed approximately 25 percent. If the soil moisture content is in the range of 25 to 35 percent, 5 to 7 percent by weight of dry soil is recommended. The amount of cement added to the soil may need to be adjusted based on field observations and performance.

When used for construction of pavement, staging, or haul road subgrades, the amended surface should be protected from abrasion by placing a minimum 4-inch thickness of crushed rock. To prevent strength loss during curing, cement-amended soil should be allowed to cure for a minimum of four days prior to placing the crushed rock. The crushed rock may typically become contaminated with soil during construction. Contaminated base rock should be removed and replaced with clean rock in pavement areas such that the minimum thickness of free-draining base at the surface is 4 inches.

It is not possible to amend soil during heavy or continuous rainfall. Work should be completed during suitable conditions.

### **6.5. Excavation**

Based on the materials encountered in our subsurface exploration, it is our opinion that conventional earthmoving equipment in proper working condition should be capable of making necessary general excavations.

The earthwork contractor should be responsible for reviewing this report, including the boring logs, providing their own assessments, and providing equipment and methods needed to excavate the site soils while protecting subgrades.

### **6.6. Dewatering**

As discussed in Section 3.4 of this report, groundwater was encountered at depths between 7 and 9 feet bgs. We do not anticipate excavations to extend below these depths. However, if excavations do extend into saturated/wet soils they should be dewatered. Sump pumps are expected to adequately address groundwater encountered in shallow excavations. Deeper excavations may require more intensive or filtered dewatering or use of well points. Deeper excavations that extend below groundwater into sandier soils may be difficult to dewater with conventional sumps because inflow of water may promote a “running soils” condition into excavations, where sandy material flows in with seeping groundwater. For deep excavations or where running soils are encountered, dewatering from well points would likely be required to maintain an open and workable trench.

In addition to groundwater seepage and upward confining flow, surface water inflow to the excavations during the wet season can be problematic. Provisions for surface water control during earthwork and excavations should be included in the project plans and should be installed prior to commencing earthwork.

### **6.7. Trench Cuts and Trench Shoring**

All trench excavations should be made in accordance with applicable Occupational Safety and Health Administration (OSHA) and state regulations. Site soils within expected excavation depths typically range from medium stiff to stiff silt. In our opinion, native soils are generally OSHA Type B, provided there is no seepage and excavations occur during periods of dry weather. Excavations deeper than 4 feet should be shored or laid back at an inclination of 1H:1V (horizontal to vertical) for Type B soils. Flatter slopes may be necessary if workers are required to enter. Excavations made to construct footings or other structural



elements should be laid back or shored at the surface as necessary to prevent soil from falling into excavations.

Shoring for trenches less than 6 feet deep that are above the effects of groundwater should be possible with a conventional box system. Slight to moderate sloughing should be expected outside the box. Shoring deeper than 6 feet or below the groundwater table should be designed by a registered engineer before installation. Further, the shoring design engineer should be provided with a copy of this report.

In our opinion, the contractor will be in the best position to observe subsurface conditions continuously throughout the construction process and to respond to the soil and groundwater conditions. Construction site safety is generally the sole responsibility of the contractor, who also is solely responsible for the means, methods and sequencing of the construction operations and choices regarding excavations and shoring. Under no circumstances should the information provided by GeoEngineers be interpreted to mean that GeoEngineers is assuming responsibility for construction site safety or the contractor's activities; such responsibility is not being implied and should not be inferred.

## **6.8. Erosion Control**

Erosion control plans are required on construction projects located within Marion County in accordance with Oregon Administrative Rules (OAR) 340-41-006 and 340-41-455 and City of Wilsonville (City) regulations. Measures that can be employed to reduce erosion include the use of silt fences, hay bales, buffer zones of natural growth, sedimentation ponds and granular haul roads.

## **6.9. Structural Fill and Backfill**

### **6.9.1. General**

Structural areas include areas beneath foundations, floor slabs, pavements, and any other areas intended to support structures or within the influence zone of structures, should generally meet the criteria for structural fill presented below. All structural fill soils should be free of debris, clay balls, roots, organic matter, frozen soil, man-made contaminants, particles with greatest dimension exceeding 4 inches (3-inch maximum particle size in building footprints) and other deleterious materials. The suitability of soil for use as structural fill will depend on the gradation and moisture content of the soil. As the amount of fines in the soil matrix increases, the soil becomes increasingly more sensitive to small changes in moisture content and achieving the required degree of compaction becomes more difficult or impossible. Recommendations for suitable fill material are provided in the following sections.

### **6.9.2. On-Site Soils**

On-site near-surface soil consists of native silt (Willamette Silt). On-site soils can be used as structural fill, provided the material meets the above requirements, although due to moisture sensitivity, this material will likely be unsuitable as structural fill during most of the year. If the soil is too wet to achieve satisfactory compaction, moisture conditioning by drying back the material will be required. If the material cannot be properly moisture conditioned, we recommend using imported material for structural fill.

An experienced geotechnical engineer from GeoEngineers should determine the suitability of on-site soil encountered during earthwork activities for reuse as structural fill.

### 6.9.3. Imported Select Structural Fill

Select imported granular material may be used as structural fill. The imported material should consist of pit or quarry run rock, crushed rock, or crushed gravel and sand that is fairly well-graded between coarse and fine sizes (approximately 25 to 65 percent passing the U.S. No. 4 sieve). It should have less than 5 percent passing the U.S. No. 200 sieve and have a minimum of 75 percent fractured particles according to American Association of State Highway and Transportation Officials (AASHTO) TP-61.

### 6.9.4. Aggregate Base

Aggregate base material located under floor slabs and pavements and crushed rock used in footing overexcavations should consist of imported clean, durable, crushed angular rock. Such rock should be well-graded, have a maximum particle size of 1 inch and have less than 5 percent passing the U.S. No. 200 sieve (3 percent for retaining walls), and meet the gradation requirements in Table 2. In addition, aggregate base shall have a minimum of 75 percent fractured particles according to AASHTO TP-61 and a sand equivalent of not less than 30 percent based on AASHTO T-176.

**TABLE 2. RECOMMENDED GRADATION FOR AGGREGATE BASE**

Sieve Size	Percent Passing (by weight)
1 inch	100
½ inch	50 to 65
No. 4	40 to 60
No. 40	5 to 15
No. 200	0 to 5

### 6.9.5. Trench Backfill

Backfill for pipe bedding and in the pipe zone should consist of well-graded granular material with a maximum particle size of ¾ inch and less than 5 percent passing the U.S. No. 200 sieve. The material should be free of organic matter and other deleterious materials. Further, the backfill should meet the pipe manufacturer’s recommendations. Above the pipe zone backfill, Imported Select Structural Fill may be used as described above.

## 6.10. Fill Placement and Compaction

Structural fill should be compacted at moisture contents that are within 3 percent of the optimum moisture content as determined by ASTM Test Method D 1557 (Modified Proctor). The optimum moisture content varies with gradation and should be evaluated during construction. Fill material that is not near the optimum moisture content should be moisture conditioned prior to compaction.

Fill and backfill material should be placed in uniform, horizontal lifts, and compacted with appropriate equipment. The appropriate lift thickness will vary depending on the material and compaction equipment used. Fill material should be compacted in accordance with Table 3, below. It is the contractor’s responsibility to select appropriate compaction equipment and place the material in lifts that are thin enough to meet these criteria. However, in no case should the loose lift thickness exceed 18 inches.

**TABLE 3. COMPACTION CRITERIA**

Fill Type	Compaction Requirements		
	Percent Maximum Dry Density Determined by ASTM Test Method D 1557 at ± 3% of Optimum Moisture		
	0 to 2 Feet Below Subgrade	> 2 Feet Below Subgrade	Pipe Zone
Fine-grained soils (non-expansive)	92	92	----
Imported Granular, maximum particle size < 1¼ inch	95	95	----
Imported Granular, maximum particle size 1¼ inch to 4 inches (3-inch maximum under building footprints)	n/a (proof-roll)	n/a (proof-roll)	----
Retaining Wall Backfill*	92	92	-----
Nonstructural Zones	90	90	90
Trench Backfill	95	90	90

Note:

\* Measures should be taken to prevent overcompaction of the backfill behind retaining walls. We recommend placing the zone of backfill located within 5 feet of the wall in lifts not exceeding about 6 inches in loose thickness and compacting this zone with hand-operated equipment such as a vibrating plate compactor and a jumping jack.

A representative from GeoEngineers should evaluate compaction of each lift of fill. Compaction should be evaluated by compaction testing unless other methods are proposed for oversized materials and are approved by GeoEngineers during construction. These other methods typically involve procedural placement and compaction specifications together with verifying requirements such as proof-rolling.

## 6.11. Slopes

### 6.11.1. Permanent Slopes

Permanent cut or fill slopes should not exceed a gradient of 2H:1V. Where access for landscape maintenance is desired, we recommend a maximum gradient of 3H:1V. Fill slopes should be overbuilt by at least 12 inches and trimmed back to the required slope to maintain a firm face.

Slopes should be planted with appropriate vegetation to provide protection against erosion as soon as possible after grading. Surface water runoff should be collected and directed away from slopes to prevent water from running down the face of the slope.

### 6.11.2. Temporary Slopes

All temporary soil cuts associated with site excavations (greater than 4 feet in depth) should be adequately sloped back to prevent sloughing and collapse, in accordance with applicable OSHA and state guidelines.

Temporary cut slopes should not exceed a gradient appropriate for the soil type being excavated. As noted in Section 6.7, medium stiff silt soils should be considered OSHA Soil Type B. However, because of the variables involved, actual slope angles required for stability in temporary cut areas can only be estimated before construction.

The stability and safety of cut slopes depend on a number of factors, including:

- The type and density of the soil.
- The presence and amount of any seepage.
- Depth of cut.
- Proximity and magnitude of the cut to any surcharge loads, such as stockpiled material, traffic loads or structures.
- Duration of the open excavation.
- Care and methods used by the contractor.

We recommend that stability of the temporary slopes used for construction be the responsibility of the contractor, since the contractor is in control of the construction operation and is continuously at the site to observe the nature and condition of the subsurface. If groundwater seepage is encountered within the excavation slopes, the cut slope inclination may have to be flatter than 1.5H:1V. However, appropriate inclinations will ultimately depend on the actual soil and groundwater seepage conditions exposed in the cuts at the time of construction. It is the responsibility of the contractor to ensure that the excavation is properly sloped or braced for worker protection, in accordance with applicable guidelines. To assist with this effort, we make the following recommendations regarding temporary excavation slopes:

- Protect the slope from erosion with plastic sheeting for the duration of the excavation to minimize surface erosion and raveling.
- Limit the maximum duration of the open excavation to the shortest time period possible.
- Place no surcharge loads (equipment, materials, etc.) within 10 feet of the top of the slope.

More restrictive requirements may apply depending on specific site conditions, which should be continuously assessed by the contractor.

If temporary sloping is not feasible based on site spatial constraints, excavations could be supported by internally braced shoring systems, such as a trench box or other temporary shoring. There are a variety of options available. We recommend that the contractor be responsible for selecting the type of shoring system to apply.

### **6.11.3. Slope Drainage**

If seepage is encountered at the face of permanent or temporary slopes, it will be necessary to flatten the slopes or install a subdrain to collect the water. We should be contacted to evaluate such conditions on a case-by-case basis.

## **7.0 STRUCTURAL DESIGN RECOMMENDATIONS**

### **7.1. Foundation Support Recommendations**

Proposed structures can be satisfactorily founded on continuous strip or isolated column footings supported on firm native soils, or on structural fill placed over native soils. Exterior footings should be

established at least 18 inches below the lowest adjacent grade. The recommended minimum footing depth is greater than the anticipated frost depth. Interior footings can be founded a minimum of 12 inches below the top of the floor slab. Continuous wall footings should have a minimum width equal to 18 inches. Isolated column and continuous wall footings should have minimum widths of 24 and 18 inches, respectively. We have assumed that the maximum isolated column loads will be on the order of 75 kips, wall loads will be 4 klf or less and floor loads for slabs-on-grade will be 100 psf or less for the proposed development. If design loads exceed these values, we should be notified as our recommendations may need to be revised.

#### **7.1.1. Foundation Subgrade Preparation**

We recommend that prepared subgrades be observed by a member of our firm, who will evaluate the suitability of the subgrade and identify any areas of yielding, which are indicative of soft or loose soil. The exposed subgrade soil should be probed with a ½-inch-diameter steel rod. If soft, yielding or otherwise unsuitable areas are revealed during probing the unsuitable soils should be removed and replaced with structural fill, as needed.

Fill material encountered at subgrade elevation should be evaluated by GeoEngineers during construction. Soft fill or fill with significant debris or unsuitable material should be removed to native medium stiff or stiffer material and replaced with compacted structural fill. The width of the overexcavation should extend beyond the edge of the footing a distance equal to the depth of the overexcavation below the base of the footing.

We recommend loose or disturbed soils be removed before placing reinforcing steel and concrete. Foundation bearing surfaces should not be exposed to standing water. If water infiltrates and pools in the excavation, the water, along with any disturbed soil, should be removed before placing reinforcing steel. A thin layer (2 to 3 inches) of crushed rock can be used to provide protection to the subgrade from light foot traffic. Compaction should be performed as described in Section 6.10.

We recommend GeoEngineers observe all foundation excavations before placing concrete forms and reinforcing steel to determine that bearing surfaces have been adequately prepared and the soil conditions are consistent with those observed during our explorations.

#### **7.1.2. Bearing Capacity – Spread Footings**

We recommend conventional footings be proportioned using a maximum allowable bearing pressure of 2,500 psf if supported on medium stiff or stiffer native silt or structural fill bearing on these materials. The recommended bearing pressure applies to the total of dead and long-term live loads and may be increased by one-third when considering earthquake or wind loads. This is a net bearing pressure. The weight of the footing and overlying backfill can be ignored in calculating footing sizes.

#### **7.1.3. Foundation Settlement**

Foundations designed and constructed as recommended are expected to experience settlements of less than 1 inch. Differential settlements of up to one half of the total settlement magnitude can be expected between adjacent footings supporting comparable loads.

#### **7.1.4. Lateral Resistance**

Lateral loads on footings can be resisted by passive earth pressures on the sides of footings and by friction on the bearing surface. We recommend that passive earth pressures be calculated using an equivalent fluid unit weight of 260 pounds per cubic foot (pcf) for foundations confined by native medium stiff or stiffer silt and 400 pcf if confined by a minimum of 2 feet of imported granular fill.

We recommend using a friction coefficient of 0.40 for foundations placed on the native medium dense or denser silt, or 0.50 for foundations placed on a minimum 1-foot-thickness of compacted crushed rock. The passive earth pressure and friction components may be combined provided the passive component does not exceed two-thirds of the total.

The passive earth pressure value is based on the assumptions that the adjacent grade is level and static groundwater remains below the base of the footing throughout the year. The top 1 foot of soil should be neglected when calculating passive lateral earth pressures unless the adjacent area is covered with pavement or slab-on-grade. The lateral resistance values include a safety factor of approximately 1.5.

#### **7.2. Drainage Considerations**

We recommend the ground surface be sloped away from the buildings at least 2 percent. All downspouts should be tightlined away from the building foundation areas and should also be discharged into a stormwater disposal system. Downspouts should not be connected to footing drains.

Although not required based on expected groundwater depths, if perimeter footing drains are used for below-grade structural elements or crawlspaces, they should be installed at the base of the exterior footings. If used, perimeter footing drains should be provided with cleanouts and should consist of at least 4-inch-diameter perforated pipe placed on a 3-inch bed of, and surrounded by, 6 inches of drainage material enclosed in a non-woven geotextile such as Mirafi 140N (or approved equivalent) to prevent fine soil from migrating into the drain material. We recommend against using flexible tubing for footing drainpipes. The perimeter drains should be sloped to drain by gravity to a suitable discharge point, preferably a storm drain. We recommend that the cleanouts be covered and placed in flush-mounted utility boxes. Water collected in roof downspout lines must not be routed to the footing drain lines.

If an elevator pit or utility vaults or other subterranean open structural elements are installed below the expected level of groundwater, we recommend foundation drains be installed as described above. Active dewatering or tightline routing of draining water will be required during wet times of the year at these locations in order to provide a removal pathway.

#### **7.3. Floor Slabs**

Satisfactory subgrade support for floor slabs supporting up to 125 psf floor loads can be obtained provided the floor slab subgrade is as described in Section 6.2 of this report. Slabs should be reinforced according to their proposed use and per the structural engineer's recommendations. Subgrade support for concrete slabs can be obtained from the medium stiff or stiffer native soils. We recommend that on-grade slabs be underlain by a minimum 6-inch-thick compacted crushed rock base section to reduce the potential for moisture migration into the slab and to provide structural support as noted below. The crushed rock base material should consist of Aggregate Base material as described Section 6.9 of this report. The material should be placed as recommended in Section 6.10.

If dry slabs are required (e.g., where moisture-sensitive adhesives are used to anchor carpet or tile to the slab), a waterproof liner may be placed as a vapor barrier below the slab. The vapor barrier should be selected by the structural engineer and should be accounted for in the design floor section and mix design selection for the concrete, to accommodate the effect of the vapor barrier on concrete slab curing. Load-bearing concrete slabs should be designed assuming a modulus of subgrade reaction ( $k$ ) of 125 psi per inch. We estimate that concrete slabs constructed as recommended will settle less than ½ inch. We recommend that the floor slab subgrade be evaluated by proof-rolling prior to placing concrete.

#### 7.4. Seismic Design

Parameters provided in Table 4 are based on the conditions encountered during our subsurface exploration program and the procedure outlined in the 2015 International Building Code (IBC). Some jurisdictions are beginning to adopt the 2018 IBC, which references the 2016 Minimum Design Loads for Buildings and Other Structures (American Society of Civil Engineers [ASCE] 7-16). Per ASCE 7-16 Section 11.4.8, a ground motion hazard analysis or site-specific response analysis is required to determine the design ground motions for structures on Site Class D sites with  $S_1$  greater than or equal to 0.2g.

For this project, the site is classified as Site Class D with an  $S_1$  value of 0.383g; therefore, the provision of 11.4.8 applies. Alternatively, the parameters listed in Table 5 below may be used to determine the design ground motions if Exception 2 of Section 11.4.8 of ASCE 7-16 is used. Using this exception, the seismic response coefficient ( $C_s$ ) is determined by Equation (Eq.) (12.8-2) for values of  $T \leq 1.5T_s$ , and taken as equal to 1.5 times the value computed in accordance with either Eq. (12.8-3) for  $T_L \geq T > 1.5T_s$  or Eq. (12.8-4) for  $T > T_L$ , where  $T$  represents the fundamental period of the structure and  $T_s=0.762$  sec. If requested, we can complete a site-specific seismic response analysis, which might provide somewhat reduced seismic demands from the parameters in Table 5 and the requirements for using Exception 2 of Section 11.4.8 in ASCE 7-16. The reduced values will likely not be significant enough to warrant the additional cost of further evaluation if designing to 2018 IBC.

We recommend seismic design be performed using the values noted in Tables 4 or 5 below depending on the version of the IBC used for design.

**TABLE 4. MAPPED 2015 IBC SEISMIC DESIGN PARAMETERS**

Parameter	Recommended Value <sup>1</sup>
Site Class	D
Mapped Spectral Response Acceleration at Short Period ( $S_s$ )	0.931 g
Mapped Spectral Response Acceleration at 1 Second Period ( $S_1$ )	0.411 g
Site Modified Peak Ground Acceleration ( $PGA_M$ )	0.446 g
Site Amplification Factor at 0.2 second period ( $F_a$ )	1.127
Site Amplification Factor at 1.0 second period ( $F_v$ )	1.589
Design Spectral Acceleration at 0.2 second period ( $S_{DS}$ )	0.70 g
Design Spectral Acceleration at 1.0 second period ( $S_{D1}$ )	0.435 g

Note:

<sup>1</sup> Parameters developed based on Latitude 45.325360° and Longitude -122.766416° using the ATC Hazards online tool.

**TABLE 5. MAPPED 2018 IBC SEISMIC DESIGN PARAMETERS**

Parameter	Recommended Value <sup>1,2</sup>
Site Class	D
Mapped Spectral Response Acceleration at Short Period ( $S_s$ )	0.822 g
Mapped Spectral Response Acceleration at 1 Second Period ( $S_1$ )	0.383 g
Site Modified Peak Ground Acceleration ( $PGA_M$ )	0.459 g
Site Amplification Factor at 0.2 second period ( $F_a$ )	1.171
Site Amplification Factor at 1.0 second period ( $F_v$ )	1.917
Design Spectral Acceleration at 0.2 second period ( $S_{DS}$ )	0.642 g
Design Spectral Acceleration at 1.0 second period ( $S_{D1}$ )	0.489 g

Notes:

<sup>1</sup> Parameters developed based on Latitude 45.325360° and Longitude -122.766416° using the ATC Hazards online tool.

<sup>2</sup> These values are only valid if the structural engineer utilizes Exception 2 of Section 11.4.8 (ASCE 7-16).

#### 7.4.1. Liquefaction Potential

Liquefaction is a phenomenon caused by a rapid increase in pore water pressure that reduces the effective stress between soil particles to near zero. The excessive buildup of pore water pressure results in the sudden loss of shear strength in a soil. Granular soil, which relies on interparticle friction for strength, is susceptible to liquefaction until the excess pore pressures can dissipate. Sand boils and flows observed at the ground surface after an earthquake are the result of excess pore pressures dissipating upwards, carrying soil particles with the draining water. In general, loose, saturated sand soil with low silt and clay contents is the most susceptible to liquefaction. Low plasticity, silty sand may be moderately susceptible to liquefaction under relatively higher levels of ground shaking.

Based on our boring logs and the water well logs reviewed at the test site, the groundwater is approximately 7 to 9 feet bgs, indicating that the materials above this elevation are not susceptible to liquefaction. The soils below the groundwater table predominantly consist of a medium stiff to stiff silt with the exception of the noted interbeds consisting of generally medium stiff to stiff silt and silt with sand, to medium dense silty sand. The medium dense silty sand interbeds (thickness ranging from 0 to 4 feet) is marginally susceptible to liquefaction. Based on our analyses, we estimate liquefaction-induced settlement at the site will be less than ½ inch at the ground surface during a seismic event.

## 8.0 OTHER CONSIDERATIONS

### 8.1. Frost Penetration

The near-surface soils are slightly susceptible to frost heave. However, floor slabs are expected to bear on compacted granular fill and the foundations will be founded below the anticipated depth of frost penetration in the region, which is approximately 12 inches. The recommended exterior and interior footing embedment depths provided above should allow adequate frost protection.

### 8.2. Expansive Soils

Based on our laboratory test results and experience with similar soils in the area, we do not consider the soils encountered in our borings to be expansive.



## 9.0 PAVEMENT RECOMMENDATIONS

### 9.1. Visual Pavement Surface Assessment

We performed a visual survey to evaluate existing pavement conditions at the site. The visual survey was not intended to evaluate ride roughness or friction, but to assess general conditions in the north main parking lots and the north and south entrance drives.

In general, the existing pavement is in relatively good condition in terms of serviceability (if not aesthetically), but many areas had been crack-sealed and some areas had a thin pavement slurry (seal coat) overlain at the surface. We did not observe significantly large areas that were broken by closely spaced cracks (“gatoring”), were deeply potholed or pitted, or were deeply rutted or heaving. Overall conditions varied between the entrance roads and the parking areas, however, so they are described separately in the sections below.

#### 9.1.1. Entrance Drives

In general, the pavement along the drive aisles displays moderate transverse and longitudinal fatigue cracking with crack widths ranging from approximately hairline (less than  $\frac{1}{4}$  to  $\frac{1}{2}$  inch, which includes some soil and vegetation accumulation). The pavement surface shows slight raveling and occasional pitting along the full length of the south entrance drive and the western end of the north entrance drive. The surface conditions along eastern end of the north entrance drive, however, are generally better, with only occasional raveling visible where the sealcoat that was applied to the parking areas has been abraded.



Photo 1: North Entrance Drive – Fatigue Cracking



Photo 2: North Entrance Drive – Fatigue Cracking and Raveling. Note sealcoat on eastern section of roadway.

### 9.1.2. Parking Areas

The surface of the pavement in the main north parking areas is in generally better condition than the bulk of the entrance drives, but this appears to be largely due to the recent application of a surface seal coat. In areas where the coating has worn through minor raveling and pitting are visible. The asphalt surface is broken by widely spaced, random, transverse, and longitudinal cracking with crack widths ranging from 1/8 to 1/2 inch. A thick tar-like seal has been applied to these cracks; based on the vegetation growth in the cracks that have opened within the seal material, these repairs were performed some time ago and has not been renewed.



**Photo 3: North Parking Bay –Random/ Transverse/ Longitudinal Cracking**



**Photo 4: North Parking Bay – Crack Seal closeup**

### 9.2. Dynamic Cone Penetrometer (DCP) Testing

We conducted DCP testing in general accordance with ASTM D 6951 to estimate the subgrade resilient modulus ( $M_R$ ) at each test location. We recorded penetration depth of the cone versus hammer blow count and terminated testing when at a depth of approximately 3 to 4 feet bgs. The approximate locations of the explorations are presented in Figure 2. We plotted depth of penetration versus blow count and visually assessed portions of the data where slopes were relatively constant using the equation from the Oregon Department of Transportation (ODOT) Pavement Design Guide to estimate the moduli using a conversion coefficient,  $C_r = 0.35$ . Table 6 lists our estimate of the subgrade resilient modulus, and Appendix A (Figures A-14 through A-19) provides a summary of the field data.

**TABLE 6. ESTIMATED SUBGRADE RESILIENT MODULI  
BASED ON DCP TESTING**

Boring Number	Estimated Resilient Modulus (psi)
DCP-1	5,000
DCP-2	4,900
DCP-3	5,400
DCP-4	5,700
DCP-5	4,200
DCP-6	4,600

## 10.0 PAVEMENT DESIGN & RECOMMENDATIONS

### 10.1. General

Pavement recommendations are provided below for paved parking and drive areas at the project site. Standards used for pavement design for asphalt pavement design are listed below:

- ODOT Pavement Design Guide (ODOT 2019)
- Guide for Design of Pavement Structures, American Association of State Highway and Transportation Officials (AASHTO 1993)

Our interpretations of the subgrade resilient modulus and structural coefficient for the existing pavement are based on subsurface explorations and DCP testing on existing subgrade, and visual observation of existing pavement surface. Descriptions of our input parameters and the recommended pavement designs are summarized below.

### 10.2. Traffic Loading

We developed our design traffic loading by estimating 2,500 cars per day and up to 10 delivery trucks per day. In the AASHTO pavement thickness design procedures, traffic information (vehicle weights and the number of passes) are converted into equivalent single axle loads (ESALs). One ESAL is equivalent to the amount of load/damage imparted on a pavement by the tires of a single 18-kip truck axle. The amount of ESALs attributed to a single vehicle depends of the gross weight carried by each axle, and the configuration of the axles (i.e. single, double or triple axles). A single semi-truck-trailer combination can have an ESAL value between about 0.4 and about 2.5 depending on gross weight. A single passenger vehicle typically has an ESAL value of about 0.001. ESAL values were calculated using standard ODOT truck factors and vehicle trips described above for the parking areas and the access roads. The resulting ESAL calculations are provided in Table 7 for a 20-year design period.

**TABLE 7. ESAL CALCULATION RESULTS**

Traffic Area	Design Period (years)	Calculated ESAL
Drive Lanes	20	39,902
Parking (cars only)	20	6,000

### 10.3. Input Parameters

#### 10.3.1. Base Layer and Subgrade Resilient Moduli

We used a layer coefficient of 0.10 for the aggregate base layer as suggested in Part III Section 5.4.5 of the AASHTO guide, based on the absence of evidence suggesting base layer contamination by the fine-grained subgrade soil underlying the existing pavement, to estimate a design base layer resilient modulus of 20,000 psi using Figure 2.6 in Part II, Section 2.3.5 of the AASHTO guide.

As shown in Table 6, we estimated a subgrade resilient modulus between 4,200 psi and 5,700 psi from the DCP testing described above. We used a value of 4,500 psi during analysis and design.

### 10.3.2. AASHTO Input Parameters

Input parameters used in pavement thickness design were selected based on review of typical values found in the City of Wilsonville Public Works Standards and the ODOT Pavement Design guide. The following parameters were used:

- Reliability = 90 percent
- Initial Serviceability = 4.2
- Terminal Serviceability = 2.5
- Standard Deviation = 0.49
- Layer Structural Coefficients: Hot Mix Asphalt (HMA) = 0.42; Existing Distressed Pavement = 0.20; Existing Aggregate Base = 0.10
- Layer Drainage Coefficients: HMA and Existing Distressed Pavement = 1.0; Existing Aggregate Base = 0.8

### 10.3.3. Frost Design

Frost heave requires the presence of frost-susceptible soil (i.e., fine-grained soil such as silt and clay), water, and freezing temperature; consequently, frost heave will not occur if any one of these three conditions is not present or at least one is eliminated. Based on local building codes, frost depth for the Wilsonville area is 12 inches. Standard practice for a cost-effective mitigation against frost action is to supply non-frost-susceptible materials for the upper half of the frost depth, which reduces the risk of frost-related pavement damage dramatically. The depth to the bottom of the existing pavement sections ranges from 6 to more than 24 inches. The material encountered beneath the asphalt section consisted of silt that has a low to moderate potential for frost heave. Based on the existing section thicknesses and anticipated maximum frost depth, the existing sections meet the standard practice for frost mitigation described above. However, if the project team desires full frost protection, excavation of subgrade soil or raising pavement grades will be necessary.

## 10.4. Recommendations

### 10.4.1. General

Based on the results of our explorations, testing and analyses, it is our opinion that the pavement structures can be rehabilitated by complete removal of the existing asphalt, partial grading and recompaction and potential cutting of existing aggregate base, and placement and compaction of new asphalt. We understand that if removal of the asphalt is not feasible, rehabilitation through overlay paving will repair the asphalt for a period of time. Mill and inlay is likely not a feasible option due to the relative small thickness of the existing AC (observed to be 2 to 3 inches). Therefore, two design options were considered: (1) new pavement or pavement replacement; and (2) overlay section. A 20-year design life was considered for both options.

### 10.4.2. New Pavement or Pavement Replacement Option

Based on our pavement design iterations, recommended new pavement sections or pavement replacement sections that do not result in finish grade changes are presented in Table 8.

**TABLE 8. NEW PAVEMENT OR PAVEMENT REPLACEMENT <sup>1</sup> THICKNESS**

Project Area	Design Period (years)	Asphalt Thickness (inches)	Minimum Aggregate Base Thickness (inches) <sup>2</sup>
Drive Lanes	20	3.5	10
Parking	20	2.5	8

Notes:

<sup>1</sup> For pavement replacement, may result in a 1-inch increase in grade.

<sup>2</sup> For pavement replacement, assumes new asphalt pavement is placed on existing, recompact aggregate base. Thickness based on minimum existing section thickness for encountered in each "Area."

### 10.4.3. Overlay Option

As an alternative to demolition and reconstruction of existing pavement sections to the recommended thicknesses in Table 8, we provide an overlay thickness of AC as shown in Table 9 for the existing pavements, provided grading plans and existing curb heights can tolerate the additional elevations from new AC. We do not provide a grind and inlay option for the existing asphalts because of the relatively thin existing AC section that will likely completely pull up during grinding.

With a pavement overlay option, reflective cracking will likely manifest at the surface of the new AC over a time period that is shorter than the design life of the section. The occurrence of reflective cracking can be somewhat delayed by installing an asphalt reinforcing material, such as Tensar products GlassPave (8501 or 8511), either by placing it directly on the existing pavement or between two layers of new asphalt pavement, depending on the installation condition. Normally, implementing a reinforcing material along with new asphalt overlays can delay the occurrence of reflective cracking for up to 7 to 10 years after rehabilitation. However, due to the highly distressed nature of the existing pavement, it is highly likely reflective cracking will initiate earlier.

Table 9 presents recommended overlay thicknesses. If a combination of raising grades in the driveway center and maintaining existing grades along the curbs to maintain curb exposure is desired, the reconstructed pavement thickness in Table 8 should be utilized where target finish grades do not allow for the recommended overlay thickness presented in Table 9.

**TABLE 9. OVERLAY PAVEMENT THICKNESS**

Project Area	Design Period (years)	New Asphalt Overlay Thickness (inches)
Drive Lanes	20	2.5
Parking	20	1.5

## 11.0 DESIGN REVIEW AND CONSTRUCTION SERVICES

Recommendations provided in this report are based on the assumptions and design information stated herein. We welcome the opportunity to review and discuss construction plans and specifications for this project as they are being developed. In addition, GeoEngineers should be retained to review the

geotechnical-related portions of the plans and specifications to evaluate whether they are in conformance with the recommendations provided in this report.

Satisfactory construction and earthwork performance depend to a large degree on quality of construction. Sufficient monitoring of the contractor's activities is a key part of determining that the work is completed in accordance with the construction drawings and specifications. Subsurface conditions observed during construction should be compared with those encountered during the subsurface explorations. Recognition of changed conditions often requires experience; therefore, qualified personnel should visit the site with sufficient frequency to detect whether subsurface conditions change significantly from those anticipated.

In order to continue as geotechnical engineer of record for the project, we recommend that GeoEngineers be retained to observe construction at the site to confirm that subsurface conditions are consistent with the site explorations, and to confirm that the intent of project plans and specifications relating to earthwork, pavement and foundation construction are being met.

## **12.0 LIMITATIONS**

We have prepared this report for the exclusive use of Atwell, LLC, ScanlanKemperBard, LLC, and their authorized agents and/or regulatory agencies for the proposed Parkway Woods Business Park, Parking and New Buildings project in Wilsonville, Oregon.

This report is not intended for use by others, and the information contained herein is not applicable to other sites. No other party may rely on the product of our services unless we agree in advance and in writing to such reliance.

Within the limitations of scope, schedule, and budget, our services have been executed in accordance with generally accepted practices in the area at the time this report was prepared. No warranty or other conditions, express or implied, should be understood.

## **13.0 REFERENCES**

American Association of State Highway and Transportation Officials (AASHTO). 1993. Guide for Design of Pavement Structures.

American Society of Civil Engineers (ASCE). 2017. Minimum Design Loads and Associated Criteria for Buildings and Other Structures.

International Code Council. 2015. International Building Code (IBC).

International Code Council. 2018. International Building Code (IBC).

Occupational Safety and Health Administration (OSHA) Technical Manual Section V: Chapter 2, Excavations: Hazard Recognition in Trenching and Shoring:

[http://www.osha.gov/dts/osta/otm/otm\\_v/otm\\_v\\_2.html](http://www.osha.gov/dts/osta/otm/otm_v/otm_v_2.html)

Oregon Department of Transportation (ODOT). 2018. Standard Specifications for Highway Construction. Salem, Oregon.

Oregon Department of Transportation (ODOT). 2019. ODOT Pavement Design Guide. Salem, Oregon.

Schlicker, H.G. and C.T. Finlayson. 1979. *Geology and Geologic Hazards of Northwestern Clackamas County, Oregon*: Oregon Department of Geology and Mineral Industries Bulletin 99, 79 p. 10 pl., 1:24,000 scale.





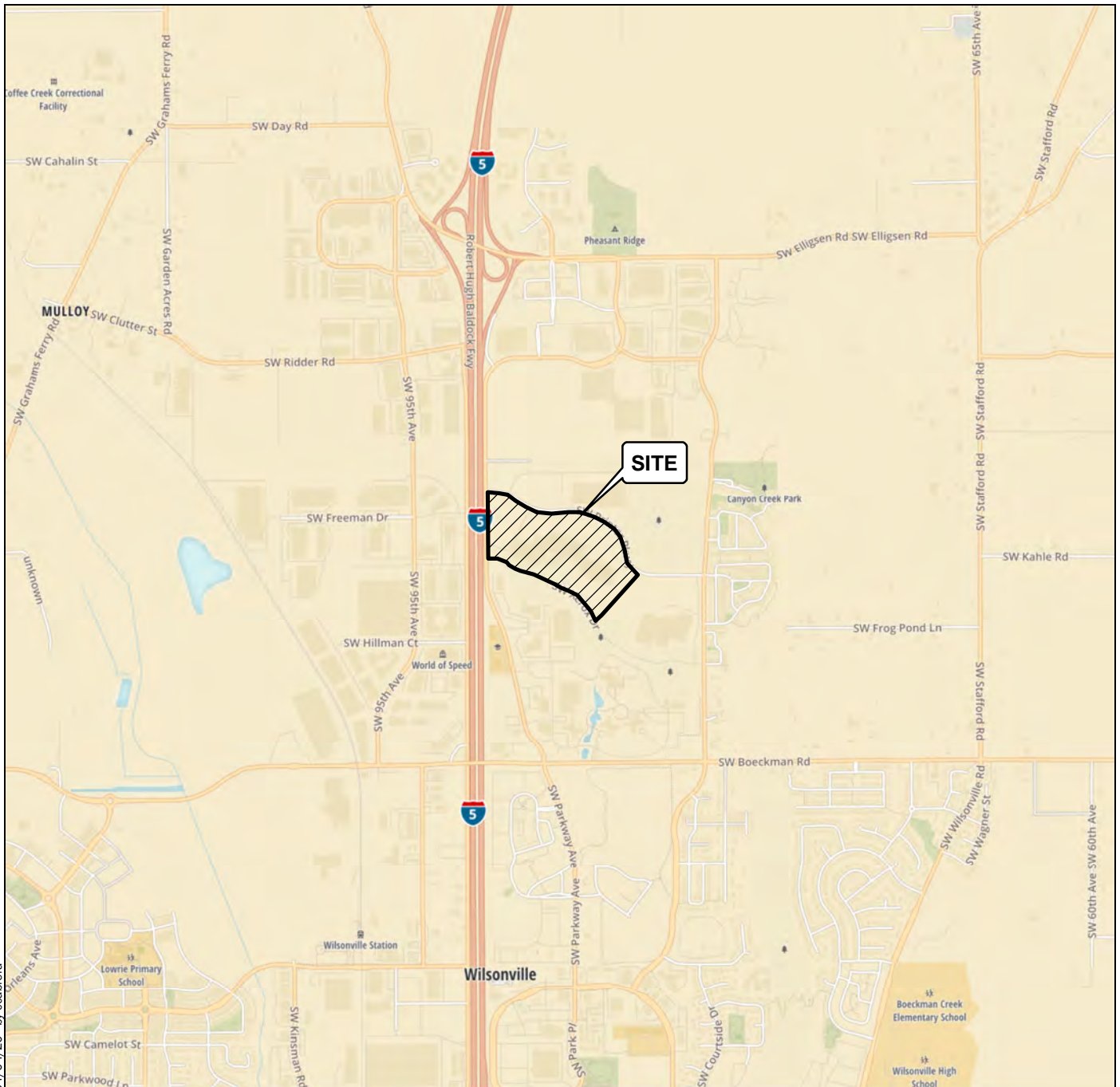

P:\23\23754001\GIS\MXD\23754001\_1\_F01\_VicinityMap.mxd Date Exported: 04/04/20 by ccabrera

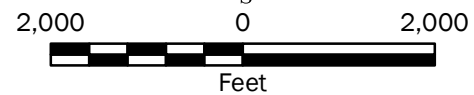
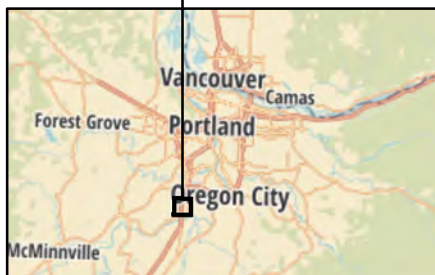

**Vicinity Map**

**Parkway Woods Business Park  
Wilsonville, Oregon**



**Figure 1**

**Notes:**

1. The locations of all features shown are approximate.
2. This drawing is for information purposes. It is intended to assist in showing features discussed in an attached document. GeoEngineers, Inc. cannot guarantee the accuracy and content of electronic files. The master file is stored by GeoEngineers, Inc. and will serve as the official record of this communication.

Data Source: Mapbox Open Street Map, 2016

Projection: NAD 1983 UTM Zone 10N



P:\23\23754001\GIS\MXD\2375400101\_F02\_SP.mxd Date Exported: 04/13/20 by ccabrera

**Notes:**  
 1. The locations of all features shown are approximate.  
 2. This drawing is for information purposes. It is intended to assist in showing features discussed in an attached document. GeoEngineers, Inc. cannot guarantee the accuracy and content of electronic files. The master file is stored by GeoEngineers, Inc. and will serve as the official record of this communication.

Data Source: Clarity

Projection: NAD 1983 StatePlane Oregon North FIPS 3601 Feet Intl

**Legend**

	Boring Number and Approximate Location (GeoEngineers 2020)		Boring Number and Approximate Location (GeoEngineers 2019)
	Core Number and Approximate Location (GeoEngineers 2020)		Core Number and Approximate Location (GeoEngineers 2019)
	Hand Auger Number and Approximate Location (GeoEngineers 2020)		Infiltration Test Number and Approximate Location (GeoEngineers 2019)
	Infiltration Number and Approximate Location (GeoEngineers 2020)		

<b>Site Plan</b>	
Parkway Woods Business Park Wilsonville, Oregon	
	<b>Figure 2</b>



**APPENDIX A**  
**Field Explorations and Laboratory Testing**

## **APPENDIX A**

### **FIELD EXPLORATIONS AND LABORATORY TESTING**

#### **Field Explorations**

Soil and groundwater conditions at the site were explored on March 30 and 31, 2020, by completing seven drilled borings (B-1-20 through B-4-20 and C-1-20 through C-3-20), five hand-auger borings (HA-1-20 through HA-5-20), five infiltration tests (IT-1-20 through IT-5-20), and six direct cone penetrometer (DCP) tests (DCP-1 through DCP-6) at the approximate locations shown in the Site Plan, Figure 2. The machine-drilled borings were advanced with a solid-stem auger using a trailer-mounted drill rig owned and operated by Dan Fischer Drilling.















The drilling was continuously monitored by an engineering geologist from our office who maintained detailed logs of subsurface exploration, visually classified the soil encountered, and obtained representative soil samples from the borings. Samples were collected using a 1-inch, inside-diameter, standard split spoon sampler and a 3-inch, inside-diameter, Dames and Moore (D&M) split spoon sampler. Samplers were driven into the soil using a rope and cathead 140-pound hammer, free-falling 30 inches on each blow. The number of blows required to drive the sampler each of three, 6-inch increments of penetration were recorded in the field. The sum of the blow counts for the last two, 6-inch increments of penetration was reported on the boring logs as the ASTM International (ASTM) Standard Practices Test Method D 1556 standard penetration testing (SPT) N-value. The approximate N-values for D&M samples were converted to SPT N-values using the Lacroix-Horn Conversion  $[N(SPT) = (2*N1*W1*H1)/(175*D1*D1*L1)]$ , where N1 is the non-standard blowcount, W1 is the hammer weight in pounds (140), H1 is the hammer drop height in inches (30), D1 is the non-standard sampler outside diameter in inches (3.23), and L1 is the length of penetration in inches (12)].

Recovered soil samples were visually classified in the field in general accordance with ASTM D 2488 and the classification chart listed in Key to Exploration Logs, Figure A-1. Logs of the borings are presented in Figures A-2 through A-15. The logs are based on interpretation of the field and laboratory data, and indicate the depth at which subsurface materials or their characteristics change, although these changes might actually be gradual.

#### **Laboratory Testing**







Soil samples obtained from the explorations were visually classified in the field and in our laboratory using the Unified Soil Classification System (USCS) and ASTM classification methods. ASTM Test Method D 2488 was used to visually classify the soil samples, while ASTM D 2487 was used to classify the soils based on laboratory tests results. Moisture content tests were performed in general accordance with ASTM D 2216-05 and moisture density tests of the ring samples were estimated in general accordance with ASTM Test Method D 7263. Atterberg limits tests were performed in accordance with ASTM D 4318. Percent fines (silt- and clay-sized particles passing the U.S. No. 200 sieve) tests (ASTM D1140) were completed on representative soil samples. Results of the laboratory testing are presented in the appropriate exploration logs at the respective sample depths.

## SOIL CLASSIFICATION CHART

MAJOR DIVISIONS			SYMBOLS		TYPICAL DESCRIPTIONS
			GRAPH	LETTER	
COARSE GRAINED SOILS	GRAVEL AND GRAVELLY SOILS	CLEAN GRAVELS <small>(LITTLE OR NO FINES)</small>		<b>GW</b>	WELL-GRADED GRAVELS, GRAVEL - SAND MIXTURES
		GRAVELS WITH FINES <small>(APPRECIABLE AMOUNT OF FINES)</small>		<b>GP</b>	POORLY-GRADED GRAVELS, GRAVEL - SAND MIXTURES
		GRAVELS WITH FINES <small>(APPRECIABLE AMOUNT OF FINES)</small>		<b>GM</b>	SILTY GRAVELS, GRAVEL - SAND - SILT MIXTURES
	SAND AND SANDY SOILS	CLEAN SANDS <small>(LITTLE OR NO FINES)</small>		<b>GC</b>	CLAYEY GRAVELS, GRAVEL - SAND - CLAY MIXTURES
		CLEAN SANDS <small>(LITTLE OR NO FINES)</small>		<b>SW</b>	WELL-GRADED SANDS, GRAVELLY SANDS
		SANDS WITH FINES <small>(APPRECIABLE AMOUNT OF FINES)</small>		<b>SP</b>	POORLY-GRADED SANDS, GRAVELLY SAND
FINE GRAINED SOILS	SILTS AND CLAYS	SANDS WITH FINES <small>(APPRECIABLE AMOUNT OF FINES)</small>		<b>SM</b>	SILTY SANDS, SAND - SILT MIXTURES
		SANDS WITH FINES <small>(APPRECIABLE AMOUNT OF FINES)</small>		<b>SC</b>	CLAYEY SANDS, SAND - CLAY MIXTURES
		LIQUID LIMIT LESS THAN 50		<b>ML</b>	INORGANIC SILTS, ROCK FLOUR, CLAYEY SILTS WITH SLIGHT PLASTICITY
	SILTS AND CLAYS	LIQUID LIMIT LESS THAN 50		<b>CL</b>	INORGANIC CLAYS OF LOW TO MEDIUM PLASTICITY, GRAVELLY CLAYS, SANDY CLAYS, SILTY CLAYS, LEAN CLAYS
		LIQUID LIMIT LESS THAN 50		<b>OL</b>	ORGANIC SILTS AND ORGANIC SILTY CLAYS OF LOW PLASTICITY
		LIQUID LIMIT GREATER THAN 50		<b>MH</b>	INORGANIC SILTS, MICACEOUS OR DIATOMACEOUS SILTY SOILS
SILTS AND CLAYS	LIQUID LIMIT GREATER THAN 50		<b>CH</b>	INORGANIC CLAYS OF HIGH PLASTICITY	
	LIQUID LIMIT GREATER THAN 50		<b>OH</b>	ORGANIC CLAYS AND SILTS OF MEDIUM TO HIGH PLASTICITY	
	LIQUID LIMIT GREATER THAN 50		<b>PT</b>	PEAT, HUMUS, SWAMP SOILS WITH HIGH ORGANIC CONTENTS	

NOTE: Multiple symbols are used to indicate borderline or dual soil classifications

### Sampler Symbol Descriptions

	2.4-inch I.D. split barrel
	Standard Penetration Test (SPT)
	Shelby tube
	Piston
	Direct-Push
	Bulk or grab
	Continuous Coring





Blowcount is recorded for driven samplers as the number of blows required to advance sampler 12 inches (or distance noted). See exploration log for hammer weight and drop.

"P" indicates sampler pushed using the weight of the drill rig.

"WOH" indicates sampler pushed using the weight of the hammer.

NOTE: The reader must refer to the discussion in the report text and the logs of explorations for a proper understanding of subsurface conditions. Descriptions on the logs apply only at the specific exploration locations and at the time the explorations were made; they are not warranted to be representative of subsurface conditions at other locations or times.

## ADDITIONAL MATERIAL SYMBOLS

SYMBOLS		TYPICAL DESCRIPTIONS
GRAPH	LETTER	
	<b>AC</b>	Asphalt Concrete
	<b>CC</b>	Cement Concrete
	<b>CR</b>	Crushed Rock/Quarry Spalls
	<b>SOD</b>	Sod/Forest Duff
	<b>TS</b>	Topsoil

### Groundwater Contact



Measured groundwater level in exploration, well, or piezometer



Measured free product in well or piezometer

### Graphic Log Contact

 Distinct contact between soil strata

 Approximate contact between soil strata

### Material Description Contact

 Contact between geologic units

 Contact between soil of the same geologic unit

### Laboratory / Field Tests

%F	Percent fines
%G	Percent gravel
AL	Atterberg limits
CA	Chemical analysis
CP	Laboratory compaction test
CS	Consolidation test
DD	Dry density
DS	Direct shear
HA	Hydrometer analysis
MC	Moisture content
MD	Moisture content and dry density
Mohs	Mohs hardness scale
OC	Organic content
PM	Permeability or hydraulic conductivity
PI	Plasticity index
PL	Point lead test
PP	Pocket penetrometer
SA	Sieve analysis
TX	Triaxial compression
UC	Unconfined compression
VS	Vane shear

### Sheen Classification

NS	No Visible Sheen
SS	Slight Sheen
MS	Moderate Sheen
HS	Heavy Sheen

## Key to Exploration Logs

Drilled	Start 3/30/2020	End 3/30/2020	Total Depth (ft)	21.5	Logged By Checked By	JLL	Driller	Dan Fischer Drilling	Drilling Method	Solid-stem Auger
Surface Elevation (ft) Vertical Datum	241 NAVD88			Hammer Data	Rope & Cathead 140 (lbs) / 30 (in) Drop			Drilling Equipment	Buck Rogers Trailer	
Easting (X) Northing (Y)	518162.51 5019300.79			System Datum	OR State Plane North NAD83 (feet)			See "Remarks" section for groundwater observed		
Notes: D&M N-values reduced using Lacroix-Horn equation to approximate SPT N-values.										

Elevation (feet)	FIELD DATA					Graphic Log	Group Classification	MATERIAL DESCRIPTION	Moisture Content (%)	Fines Content (%)	REMARKS
	Depth (feet)	Interval Recovered (in)	Blows/foot	Collected Sample	Sample Name Testing						
240	0						ML	Dark brown silt, fine roots to 4 inches (soft, moist) (Willamette Silt)			
	16	5		1	MD			Becomes yellow-brown, medium stiff	33		DD = 82 pcf
235	5	16	3	2				Grades to dark gray			
	18	25		3	MD			Becomes very stiff, trace to occasional sand, wet	42		DD = 80 pcf
230	10	16	10	4	%F		SM	Gray-brown silty fine sand, no plasticity (medium dense, moist)	32	44	Groundwater observed at 8½ feet bgs during drilling
225	15	16	7	5			ML	Gray silt, trace fine sand (medium stiff, wet)			
220	20	16	6	6							

Note: See Figure A-1 for explanation of symbols.  
Coordinates Data Source: Horizontal approximated based on Google Earth. Vertical approximated based on Google Earth.

### Log of Boring B-1-20



Project: Parkway Woods Business Park Parking  
Project Location: Wilsonville, Oregon  
Project Number: 23754-001-01

Date: 4/17/20 Path: C:\USERS\CESTES\DOCUMENTS\SHAREPOINT DRAFTS\2375400-01\GPI\_DBL\Library\Library\GEOENGINEERS\_DF\_STD\_US\_JUNE\_2017\GLB\GEBR\_GEO TECH\_STANDARD\_SF\_NO\_GW

Start Drilled	3/30/2020	End	3/30/2020	Total Depth (ft)	21.5	Logged By	JLL	Checked By		Driller	Dan Fischer Drilling	Drilling Method	Solid-stem Auger
Surface Elevation (ft)	243			Hammer Data	Rope & Cathead			Drilling Equipment		Buck Rogers Trailer			
Vertical Datum	NAVD88				140 (lbs) / 30 (in) Drop								
Easting (X)	518151.67			System Datum	OR State Plane North			See "Remarks" section for groundwater observed					
Northing (Y)	5019224.82				NAD83 (feet)								
Notes:													

Elevation (feet)	FIELD DATA					Graphic Log	Group Classification	MATERIAL DESCRIPTION	Moisture Content (%)	Fines Content (%)	REMARKS
	Depth (feet)	Interval Recovered (in)	Blows/foot	Collected Sample	Sample Name Testing						
0							ML	Dark gray brown silt, fine roots to 4 inches, some wood and charcoal fragments (soft, moist) (Willamette Silt)			
240		10	2		1			Red-brown mottling, gray			
5		16	7		2 AL			Becomes medium stiff	32		AL (LL = 39; PI = 13)
235		16	4		3			Becomes soft to medium stiff, no organic matter, dark gray, red-brown mottling			
10		16	9		4			Becomes gray-green (stiff, wet)			Groundwater observed at 9½ feet bgs during drilling
230		14	7		5			Becomes light gray with red-brown and dark gray mottling, medium stiff			
225		16	9		6			Becomes dark gray, stiff			
20											

Note: See Figure A-1 for explanation of symbols.  
Coordinates Data Source: Horizontal approximated based on Google Earth. Vertical approximated based on Google Earth.

### Log of Boring B-2-20



Project: Parkway Woods Business Park Parking  
Project Location: Wilsonville, Oregon  
Project Number: 23754-001-01

Date: 4/17/20 Path: C:\USERS\CESTES\DOCUMENTS\SHAREPOINT DRAFTS\2375400-01\GPI\_DBL\Library\Library\GEOENGINEERS\_DF\_STD\_US\_JUNE\_2017\GLB\GEBR\_GEOTECH\_STANDARD\_SF\_NO\_GW



Start Drilled	3/30/2020	End	3/30/2020	Total Depth (ft)	21.5	Logged By	JLL	Driller	Dan Fischer Drilling	Drilling Method	Solid-stem Auger
Surface Elevation (ft)	239			Hammer Data	Rope & Cathead			Drilling Equipment		Buck Rogers Trailer	
Vertical Datum	NAVD88				140 (lbs) / 30 (in) Drop						
Easting (X)	518867.3			System Datum	OR State Plane North			See "Remarks" section for groundwater observed			
Northing (Y)	5019189.88				NAD83 (feet)						
Notes: D&M N-values reduced using Lacroix-Horn equation to approximate SPT N-values.											

Elevation (feet)	FIELD DATA				Graphic Log	Group Classification	MATERIAL DESCRIPTION	Moisture Content (%)	Fines Content (%)	REMARKS
	Depth (feet)	Interval Recovered (in)	Blows/foot	Collected Sample						
0					AC	3-inch-thick asphalt concrete pavement				
					GP	1.5-inch-thick aggregate base				
					ML	Gray-brown silt, red-brown mottling (medium stiff, moist) (Willamette Silt)				
238	16	8	1							
5	16	13	2	MD		Becomes stiff	24		DD = 98 pcf	
										Groundwater observed at 7 feet bgs during drilling
230	18	21	3			Becomes brown and black with gray mottling (very stiff, wet)				
10	16	31	4	%F		Becomes yellow-brown sandy silt, fine to medium sand, occasional subround fine gravels, weakly cemented (stiff, wet)	33	54		
228										
15	16	11	5		SM	Gray-brown and black with red-brown mottling, silty sand (very loose, wet)				
					SM-ML	Gray-brown silty fine to medium sand to sandy silt, weakly cemented (stiff and medium dense, wet)				
220										
20	16	17	6			Gray with red-brown and black streaking/staining, relict igneous rock texture				

Note: See Figure A-1 for explanation of symbols.  
Coordinates Data Source: Horizontal approximated based on Google Earth. Vertical approximated based on Google Earth.

### Log of Boring B-3-20



Project: Parkway Woods Business Park Parking  
Project Location: Wilsonville, Oregon  
Project Number: 23754-001-01

Date: 4/17/20 Path: C:\USERS\CESTES\DOCUMENTS\SHAREPOINT DRAFTS\23754001\GPI\_DBL\Library\Library\GEOENGINEERS\_DF\_STD\_US\_JUNE\_2017\GLB\GEBR\_GEO TECH\_STANDARD\_SF\_NO\_GW

Start Drilled	3/30/2020	End	3/30/2020	Total Depth (ft)	21.5	Logged By	JLL	Checked By		Driller	Dan Fischer Drilling	Drilling Method	Solid-stem Auger
Surface Elevation (ft)	238			Hammer Data	Rope & Cathead			140 (lbs) / 30 (in) Drop		Drilling Equipment	Buck Rogers Trailer		
Vertical Datum	NAVD88			System Datum	OR State Plane North			NAD83 (feet)		See "Remarks" section for groundwater observed			
Easting (X)	518625.08			Notes:									
Northing (Y)	5019129.61												

Elevation (feet)	FIELD DATA					Graphic Log	Group Classification	MATERIAL DESCRIPTION	Moisture Content (%)	Fines Content (%)	REMARKS
	Depth (feet)	Interval Recovered (in)	Blows/foot	Collected Sample	Sample Name Testing						
0						AC	3-inch-thick asphalt concrete				
						GP	24-inch-thick aggregate base				
235	16	11	1			ML	Gray silt, red-brown mottling (stiff, moist) (Willamette Silt)				
5	16	7	2	AL			Becomes medium stiff, occasional fine sand	29		AL (LL = 30; PI = 4)	
230	16	6	3				Becomes wet			Groundwater observed at 7 feet bgs during drilling	
10	16	18	4				Becomes dark gray-brown with red-brown mottling, trace fine sand, very stiff				
225											
15	14	40	5	5%F		SM	Multicolored (gray, brown, occasional black) silty fine sand, occasional fine gravels (dense, wet)	36	38		
220											
20	8	18	6				Becomes medium dense, angular, blocky texture, moderately well cemented				

Note: See Figure A-1 for explanation of symbols.  
Coordinates Data Source: Horizontal approximated based on Google Earth. Vertical approximated based on Google Earth.

### Log of Boring B-4-20



Project: Parkway Woods Business Park Parking  
Project Location: Wilsonville, Oregon  
Project Number: 23754-001-01

Date: 4/17/20 Path: C:\USERS\CESTES\DOCUMENTS\SHAREPOINT DRAFTS\23754001\GPI\_DBL\Library\Library\GEOENGINEERS\_DF\_STD\_US\_JUNE\_2017\GLB\GEBR\_GEOTECH\_STANDARD\_SF\_NO\_GW

Start Drilled	3/30/2020	End	3/30/2020	Total Depth (ft)	6.5	Logged By	JLL	Checked By		Driller	Dan Fischer Drilling	Drilling Method	Solid-stem Auger
Surface Elevation (ft)	234			Vertical Datum	NAVD88	Hammer Data	Rope & Cathead 140 (lbs) / 30 (in) Drop			Drilling Equipment	Buck Rogers Trailer		
Easting (X)	518184.94			System Datum	OR State Plane North	OR State Plane North NAD83 (feet)			Groundwater not observed at time of exploration				
Notes:													

Elevation (feet)	FIELD DATA					Graphic Log	Group Classification	MATERIAL DESCRIPTION	Moisture Content (%)	Fines Content (%)	REMARKS
	Depth (feet)	Interval Recovered (in)	Blows/foot	Collected Sample	Sample Name Testing						
0						AC	2-inch-thick asphalt concrete				
						GP	4-inch-thick aggregate base course				
						ML	Light gray-brown silt, trace fine sand (stiff, moist) (Willamette Silt)				DCP 1 at 13 inches
5	16	10		1							
	14	13		2							
							Grades to silt with fine to medium sand				

Note: See Figure A-1 for explanation of symbols.  
Coordinates Data Source: Horizontal approximated based on Google Earth. Vertical approximated based on Google Earth.

### Log of Boring B-5-20 (C-1)



Project: Parkway Woods Business Park Parking  
Project Location: Wilsonville, Oregon  
Project Number: 23754-001-01

Figure A-6  
Sheet 1 of 1

Drilled	Start 3/30/2020	End 3/30/2020	Total Depth (ft)	6.5	Logged By Checked By	JLL	Driller	Dan Fischer Drilling	Drilling Method	Solid-stem Auger
Surface Elevation (ft) Vertical Datum	236 NAVD88			Hammer Data	Rope & Cathead 140 (lbs) / 30 (in) Drop			Drilling Equipment	Buck Rogers Trailer	
Easting (X) Northing (Y)	518291.97 5019185.08			System Datum	OR State Plane North NAD83 (feet)			Groundwater not observed at time of exploration		
Notes:										

Elevation (feet)	FIELD DATA					Graphic Log	Group Classification	MATERIAL DESCRIPTION	Moisture Content (%)	Fines Content (%)	REMARKS
	Depth (feet)	Interval Recovered (in)	Blows/foot	Collected Sample	Sample Name Testing						
235	0					AC	2½-inch-thick asphalt concrete pavement			DCP 2 at 13 inches	
						GM	8½-inch-thick aggregate base course				
		16	11		1	ML	Gray silt, trace fine sand, red-brown mottling (stiff, moist) (Willamette Silt)				
							Grades to yellow-gray with red-brown mottling				
230	5	14	19		2	SM	Gray-brown silty fine to medium sand (medium dense, moist)				

Note: See Figure A-1 for explanation of symbols.  
Coordinates Data Source: Horizontal approximated based on Google Earth. Vertical approximated based on Google Earth.

### Log of Boring B-6-20 (C-2)



Project: Parkway Woods Business Park Parking  
Project Location: Wilsonville, Oregon  
Project Number: 23754-001-01

Date: 4/17/20 Path: C:\USERS\CESTES\DOCUMENTS\SHAREPOINT DRAFTS\2375400-01\GPI\_DB\Library\Library\GEOENGINEERS\_DF\_STD\_US\_JUNE\_2017\GLB\GEBR\_GEOTECH\_STANDARD\_MF\_NO\_GW

Start Drilled	3/30/2020	End	3/30/2020	Total Depth (ft)	6.5	Logged By	JLL	Checked By		Driller	Dan Fischer Drilling	Drilling Method	Solid-stem Auger
Surface Elevation (ft)	235			Vertical Datum	NAVD88	Hammer Data	Rope & Cathead 140 (lbs) / 30 (in) Drop			Drilling Equipment	Buck Rogers Trailer		
Easting (X)	518421.99			Northing (Y)	5019216.51	System Datum	OR State Plane North NAD83 (feet)			Groundwater not observed at time of exploration			
Notes:													

Elevation (feet)	FIELD DATA					Graphic Log	Group Classification	MATERIAL DESCRIPTION	Moisture Content (%)	Fines Content (%)	REMARKS
	Depth (feet)	Interval Recovered (in)	Blows/foot	Collected Sample	Sample Name Testing						
0						AC	2- to 2½-inch-thick asphalt concrete pavement			DCP-3 at 13 inches	
						GM	10-inch-thick aggregate base course				
						ML	Yellow-gray silt with red-brown mottling, trace fine sand (stiff, moist) (Willamette Silt)				
	14	11		1							
5	18	7		2			Becomes medium stiff				

Note: See Figure A-1 for explanation of symbols.  
Coordinates Data Source: Horizontal approximated based on Google Earth. Vertical approximated based on Google Earth.

### Log of Boring B-7-20 (C-3)



Project: Parkway Woods Business Park Parking  
Project Location: Wilsonville, Oregon  
Project Number: 23754-001-01

Figure A-8  
Sheet 1 of 1

Date: 4/17/20 Path: C:\USERS\CESTES\DOCUMENTS\SHAREPOINT DRAFTS\2375400-01\GPI\_DB\Library\Library\GEOENGINEERS\_DF\_STD\_US\_JUNE\_2017\GLB\GEBR\_GEO TECH\_STANDARD\_MF\_NO\_GW

Drilled	Start 3/30/2020	End 3/30/2020	Total Depth (ft)	7.5	Logged By Checked By	JLL TNG	Driller	GEI	Drilling Method	Hand Auger
Surface Elevation (ft) Vertical Datum	231 NAVD88			Hammer Data	Rope & Cathead 140 (lbs) / 30 (in) Drop			Drilling Equipment	Hand Auger	
Easting (X) Northing (Y)	518212.04 5019032.35			System Datum	OR State Plane North NAD83 (feet)			See "Remarks" section for groundwater observed		
Notes: See Figure A-1 for explanation of symbols. The depths on the hand-augered boring logs are based on an average of measurements across the hand-auger and should be considered accurate to 1/2 foot.										

Elevation (feet)	FIELD DATA					Group Classification	MATERIAL DESCRIPTION	Moisture Content (%)	Fines Content (%)	REMARKS
	Depth (feet)	Interval Recovered (in)	Blows/foot	Collected Sample	Sample Name Testing					
230	0					CL	Dark brown lean clay, occasional roots to 6 to 10 inches (medium stiff, moist) (Willamette Silt)			
	6	6			1		Grades to yellow-brown with red-brown mottling			
225	5	6			2		Grades to stiff Grades to silt with fine to medium sand			
	6	6			3		Becomes wet			Groundwater observed at 7 feet bgs during exploration

Date: 4/17/20 Path: C:\USERS\CESTES\DOCUMENTS\SHAREPOINT DRAFTS\2375400-01\GPI\_DBLibrary\Library\GEOENGINEERS\_DF\_STD\_US\_JUNE\_2017\GLB\GEBR\_GEOTECH\_STANDARD\_MF\_NO\_GW

Note: See Figure A-1 for explanation of symbols.  
Coordinates Data Source: Horizontal approximated based on Google Earth. Vertical approximated based on Google Earth.

### Log of Hand Auger HA-1-20



Project: Parkway Woods Business Park Parking  
Project Location: Wilsonville, Oregon  
Project Number: 23754-001-01

Drilled	Start 3/31/2020	End 3/31/2020	Total Depth (ft)	7.5	Logged By Checked By	JLL TNG	Driller	GEI	Drilling Method	Hand Auger
Surface Elevation (ft) Vertical Datum	233 NAVD88			Hammer Data	Rope & Cathead 140 (lbs) / 30 (in) Drop			Drilling Equipment	Hand Auger	
Easting (X) Northing (Y)	518365.22 5018971.87			System Datum	OR State Plane North NAD83 (feet)			See "Remarks" section for groundwater observed		
Notes: See Figure A-1 for explanation of symbols. The depths on the hand-augered boring logs are based on an average of measurements across the hand-auger and should be considered accurate to 1/2 foot.										

Elevation (feet)	FIELD DATA					Group Classification	MATERIAL DESCRIPTION	Moisture Content (%)	Fines Content (%)	REMARKS
	Depth (feet)	Interval Recovered (in)	Blows/foot	Collected Sample	Sample Name Testing					
0						GM	Brown silty gravel, rounded gravels to 2 to 3 inches in silt matrix (loose, moist) (fill)			
3	12				1 AL	CL	Yellow-brown lean clay with red-brown mottling, occasional roots (medium stiff, moist) (Willamette Silt)	34		IT-3 at 3 feet AL (LL = 48; PI = 24)
5							Becomes silt with fine to medium sand, stiff			

Note: See Figure A-1 for explanation of symbols.  
Coordinates Data Source: Horizontal approximated based on Google Earth. Vertical approximated based on Google Earth.

### Log of Hand Auger HA-2-20 (IT-3)



Project: Parkway Woods Business Park Parking  
Project Location: Wilsonville, Oregon  
Project Number: 23754-001-01

Figure A-10  
Sheet 1 of 1

Date: 4/17/20 Path: C:\USERS\CESTES\DOCUMENTS\SHAREPOINT DRAFTS\2375400-01\GP1\_DBLibrary\Library\GEOENGINEERS\_DF\_STD\_US\_JUNE\_2017\GLB\GEBR\_GEO TECH\_STANDARD\_MF\_NO\_GW

Drilled	Start 3/31/2020	End 3/31/2020	Total Depth (ft)	3.5	Logged By Checked By	JLL TNG	Driller	GEI	Drilling Method	Hand Auger
Surface Elevation (ft) Vertical Datum	239 NAVD88			Hammer Data	Rope & Cathead 140 (lbs) / 30 (in) Drop			Drilling Equipment	Hand Auger	
Easting (X) Northing (Y)	518495.64 5018936.86			System Datum	OR State Plane North NAD83 (feet)			Groundwater not observed at time of exploration		
Notes: See Figure A-1 for explanation of symbols. The depths on the hand-augered boring logs are based on an average of measurements across the hand-auger and should be considered accurate to 1/2 foot.										

Elevation (feet)	FIELD DATA					MATERIAL DESCRIPTION	Moisture Content (%)	Fines Content (%)	REMARKS
	Depth (feet)	Interval Recovered (in)	Blows/foot	Collected Sample	Sample Name Testing				
0						ML			
	12			1 MC			29		
						GM			

Grades to yellow-brown with red-brown mottling  
Brown silty gravel, angular gravel and coarse sand (dense, moist to wet) (practical refusal on gravel)

Note: See Figure A-1 for explanation of symbols.  
Coordinates Data Source: Horizontal approximated based on Google Earth. Vertical approximated based on Google Earth.

### Log of Hand Auger HA-3-20



Project: Parkway Woods Business Park Parking  
Project Location: Wilsonville, Oregon  
Project Number: 23754-001-01

Figure A-11  
Sheet 1 of 1



Drilled	Start 3/31/2020	End 3/31/2020	Total Depth (ft)	7	Logged By Checked By	JLL TNG	Driller	GEI	Drilling Method	Hand Auger
Surface Elevation (ft) Vertical Datum	235 NAVD88			Hammer Data	Rope & Cathead 140 (lbs) / 30 (in) Drop			Drilling Equipment	Hand Auger	
Easting (X) Northing (Y)	518579.91 5018907.61			System Datum	OR State Plane North NAD83 (feet)			See "Remarks" section for groundwater observed		
Notes: See Figure A-1 for explanation of symbols. The depths on the hand-augered boring logs are based on an average of measurements across the hand-auger and should be considered accurate to 1/2 foot.										

Elevation (feet)	FIELD DATA					Graphic Log	Group Classification	MATERIAL DESCRIPTION	Moisture Content (%)	Fines Content (%)	REMARKS
	Depth (feet)	Interval Recovered (in)	Blows/foot	Collected Sample	Sample Name Testing						
0							ML	Dark brown silt, fine roots to 4 inches (medium stiff, moist) (Willamette Silt)			
								Grades to yellow-brown with red-brown mottling			
230		12			1						IT-4 at 4 feet
5											
		6			2						

Date: 4/17/20 Path: C:\USERS\CESTES\DOCUMENTS\SHAREPOINT DRAFTS\2375400-01\GPI\_DBLibrary\Library\GEOENGINEERS\_DF\_STD\_US\_JUNE\_2017\GLB\GEBR\_GEO TECH\_STANDARD\_MF\_NO\_GW

Note: See Figure A-1 for explanation of symbols.  
Coordinates Data Source: Horizontal approximated based on Google Earth. Vertical approximated based on Google Earth.

### Log of Hand Auger HA-4-20 (IT-4)



Project: Parkway Woods Business Park Parking  
Project Location: Wilsonville, Oregon  
Project Number: 23754-001-01

Figure A-12  
Sheet 1 of 1

Drilled	Start 3/31/2020	End 3/31/2020	Total Depth (ft)	7	Logged By Checked By	JLL TNG	Driller	GEI	Drilling Method	Hand Auger
Surface Elevation (ft) Vertical Datum	237 NAVD88			Hammer Data	Rope & Cathead 140 (lbs) / 30 (in) Drop			Drilling Equipment	Hand Auger	
Easting (X) Northing (Y)	518654.45 5018938.97			System Datum	OR State Plane North NAD83 (feet)			See "Remarks" section for groundwater observed		
Notes: See Figure A-1 for explanation of symbols. The depths on the hand-augered boring logs are based on an average of measurements across the hand-auger and should be considered accurate to 1/2 foot.										

Elevation (feet)	FIELD DATA					Graphic Log	Group Classification	MATERIAL DESCRIPTION	Moisture Content (%)	Fines Content (%)	REMARKS
	Depth (feet)	Interval Recovered (in)	Blows/foot	Collected Sample	Sample Name Testing						
0							ML	Dark brown silt, fine roots to 4 to 6 inches (medium stiff, moist) (Willamette Silt)			
235		12			1 MC			Grades to yellow-brown with red-brown mottling	40		IT-5 at 3 feet
5								Occasional fine to medium sand			
230											

Note: See Figure A-1 for explanation of symbols.  
Coordinates Data Source: Horizontal approximated based on Google Earth. Vertical approximated based on Google Earth.

### Log of Hand Auger HA-5-20 (IT-5)



Project: Parkway Woods Business Park Parking  
Project Location: Wilsonville, Oregon  
Project Number: 23754-001-01

Figure A-13  
Sheet 1 of 1



Drilled	Start 3/31/2020	End 3/31/2020	Total Depth (ft)	3	Logged By Checked By	JLL	Driller	Dan Fischer Drilling	Drilling Method	Solid-stem Auger
Surface Elevation (ft) Vertical Datum	Undetermined NAVD88				Hammer Data	Rope & Cathead 140 (lbs) / 30 (in) Drop		Drilling Equipment	Buck Rogers Trailer	
Easting (X) Northing (Y)					System Datum	OR State Plane North NAD83 (feet)		Groundwater not observed at time of exploration		
Notes:										

Elevation (feet)	FIELD DATA					Graphic Log	Group Classification	MATERIAL DESCRIPTION	Moisture Content (%)	Fines Content (%)	REMARKS
	Depth (feet)	Interval Recovered (in)	Blows/foot	Collected Sample	Sample Name Testing						
0						AC	3-inch-thick asphalt concrete pavement				
						GM	11-inch-thick aggregate base				
						ML	Light gray silt, low to moderate plasticity (medium stiff, moist) (Willamette silt)				
					1						

Note: See Figure A-1 for explanation of symbols.  
Coordinates Data Source: Horizontal approximated based on Google Earth. Vertical approximated based on Google Earth.

### Log of Boring IT-2-20



Project: Parkway Woods Business Park Parking  
Project Location: Wilsonville, Oregon  
Project Number: 23754-001-01

Date: 4/17/20 Path: C:\USERS\CESTES\DOCUMENTS\SHAREPOINT DRAFTS\2375400-01\GP1\_DBL\Library\Library\GEOENGINEERS\_DF\_STD\_US\_JUNE\_2017\GLB\GEBR\_GEOTECH\_STANDARD\_MF\_NO\_GW

Location: Parkway Woods Wilsonville Date: 3/30/2020  
 Depth to bottom: 48.6 121.5 Dimension: N/A  
 Tester's Name: John Lawes  
 Tester's Company: GeoEngineers, Inc. Tester's Contact No: 971-409-7390  
 Notes: Driven from base of aggregate (~13" below pavement surface)

Test Hole Number: B-5  
 Test Method: Dynamic Cone Penetration  
 GeoEngineers Job: 23754-001-01  
 Project Name Parkway Woods Business Park

Depth, feet	Soil Texture
0-1.15	Asphalt Pavement/aggregate base
1.15-6.5	Light gray brown SILT to ELASTIC SILT
	Stiff

Test increment	Number of blows	Cumulative blows	Depth below base of S-1	Penetration per increment	Cumulative penetration	Cummulative Penetration	Penetration per blow set	Penetration per blow	Hammer blow factor	DCP Index	DCP Index	CBR	M <sub>R</sub>
#	#	#	(in)	(mm)	(mm)	(in)	(in)	(in)	1 for 8-kg 2 for 4.6-kg hammer	in/blow	mm/blow	%	psi
1	1	6	0.9	22.0	22.0	0.9	0.9	0.87	1	0.87	22.00	9	5140
2	1	7	2.0	29.0	51.0	2.0	1.1	1.14	1	1.14	29.00	7	4615
3	1	8	2.8	19.0	70.0	2.8	0.7	0.75	1	0.75	19.00	11	5442
4	1	9	5.9	81.0	151.0	5.9	3.2	3.19	1	3.19	81.00	2	3091
5	1	10	6.9	24.0	175.0	6.9	0.9	0.94	1	0.94	24.00	8	4968
6	1	11	7.5	16.0	191.0	7.5	0.6	0.63	1	0.63	16.00	13	5819
7	1	12	8.7	31.0	222.0	8.7	1.2	1.22	1	1.22	31.00	6	4496
8	1	13	10.0	33.0	255.0	10.0	1.3	1.30	1	1.30	33.00	6	4388
9	1	14	11.1	26.0	281.0	11.1	1.0	1.02	1	1.02	26.00	8	4815
10	1	15	12.1	26.0	307.0	12.1	1.0	1.02	1	1.02	26.00	8	4815
11	1	16	13.0	23.0	330.0	13.0	0.9	0.91	1	0.91	23.00	9	5051
12	1	17	13.9	24.0	354.0	13.9	0.9	0.94	1	0.94	24.00	8	4968
13	1	18	14.8	23.0	377.0	14.8	0.9	0.91	1	0.91	23.00	9	5051
14	1	19	15.3	12.0	389.0	15.3	0.5	0.47	1	0.47	12.00	18	6510
15	1	20	15.9	16.0	405.0	15.9	0.6	0.63	1	0.63	16.00	13	5819
16	1	21	16.6	16.0	421.0	16.6	0.6	0.63	1	0.63	16.00	13	5819
17	1	22	17.2	15.0	436.0	17.2	0.6	0.59	1	0.59	15.00	14	5967
18	1	23	17.7	14.0	450.0	17.7	0.6	0.55	1	0.55	14.00	15	6130
19	1	24	18.3	15.0	465.0	18.3	0.6	0.59	1	0.59	15.00	14	5967
20	1	25	18.9	14.0	479.0	18.9	0.6	0.55	1	0.55	14.00	15	6130
21	1	26	19.1	5.0	484.0	19.1	0.2	0.20	1	0.20	5.00	48	9159
22	1	27	20.0	23.0	507.0	20.0	0.9	0.91	1	0.91	23.00	9	5051
23	1	28	20.5	13.0	520.0	20.5	0.5	0.51	1	0.51	13.00	17	6310
24	1	29	20.9	12.0	532.0	20.9	0.5	0.47	1	0.47	12.00	18	6510
25	1	30	21.5	13.0	545.0	21.5	0.5	0.51	1	0.51	13.00	17	6310
26	1	31	21.9	12.0	557.0	21.9	0.5	0.47	1	0.47	12.00	18	6510
27	1	32	22.4	11.0	568.0	22.4	0.4	0.43	1	0.43	11.00	20	6735
28	2	34	23.2	22.0	590.0	23.2	0.9	0.43	1	0.43	11.00	20	6735
29	2	36	24.1	22.0	612.0	24.1	0.9	0.43	1	0.43	11.00	20	6735
30	2	38	24.9	20.0	632.0	24.9	0.8	0.39	1	0.39	10.00	22	6990
31	2	40	25.7	22.0	654.0	25.7	0.9	0.43	1	0.43	11.00	20	6735
32	2	42	26.5	20.0	674.0	26.5	0.8	0.39	1	0.39	10.00	22	6990
33	2	44	27.2	17.0	691.0	27.2	0.7	0.33	1	0.33	8.50	27	7447
34	2	46	28.0	19.0	710.0	28.0	0.7	0.37	1	0.37	9.50	23	7131
35	2	48	28.5	13.0	723.0	28.5	0.5	0.26	1	0.26	6.50	36	8269
36	2	50	29.3	22.0	745.0	29.3	0.9	0.43	1	0.43	11.00	20	6735
37	2	52	29.9	15.0	760.0	29.9	0.6	0.30	1	0.30	7.50	31	7820
38	2	54	30.5	15.0	775.0	30.5	0.6	0.30	1	0.30	7.50	31	7820
39	2	56	31.1	15.0	790.0	31.1	0.6	0.30	1	0.30	7.50	31	7820
40	2	58	31.7	14.0	804.0	31.7	0.6	0.28	1	0.28	7.00	33	8033
41	2	60	32.1	11.0	815.0	32.1	0.4	0.22	1	0.22	5.50	43	8825
42	2	62	32.6	13.0	828.0	32.6	0.5	0.26	1	0.26	6.50	36	8269
43	2	64	33.1	12.0	840.0	33.1	0.5	0.24	1	0.24	6.00	39	8531
44	2	66	33.5	12.0	852.0	33.5	0.5	0.24	1	0.24	6.00	39	8531
45	2	68	34.1	13.0	865.0	34.1	0.5	0.26	1	0.26	6.50	36	8269
46	2	70	34.5	12.0	877.0	34.5	0.5	0.24	1	0.24	6.00	39	8531
47	2	72	35.0	12.0	889.0	35.0	0.5	0.24	1	0.24	6.00	39	8531
48	2	74	35.6	15.0	904.0	35.6	0.6	0.30	1	0.30	7.50	31	7820

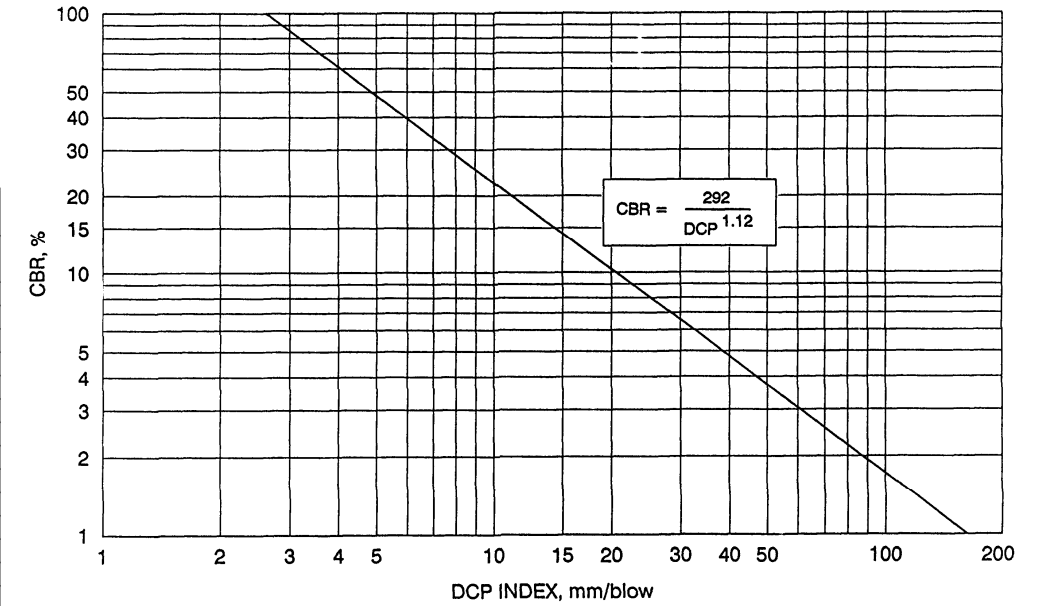

(after Webster et al., 1992)  
 Webster, S. L., Grau, R. H., and Williams, T. P. (1992). Description and application of dual mass dynamic cone penetrometer. Department of the Army Waterways Equipment Station, No. GL-92-3.

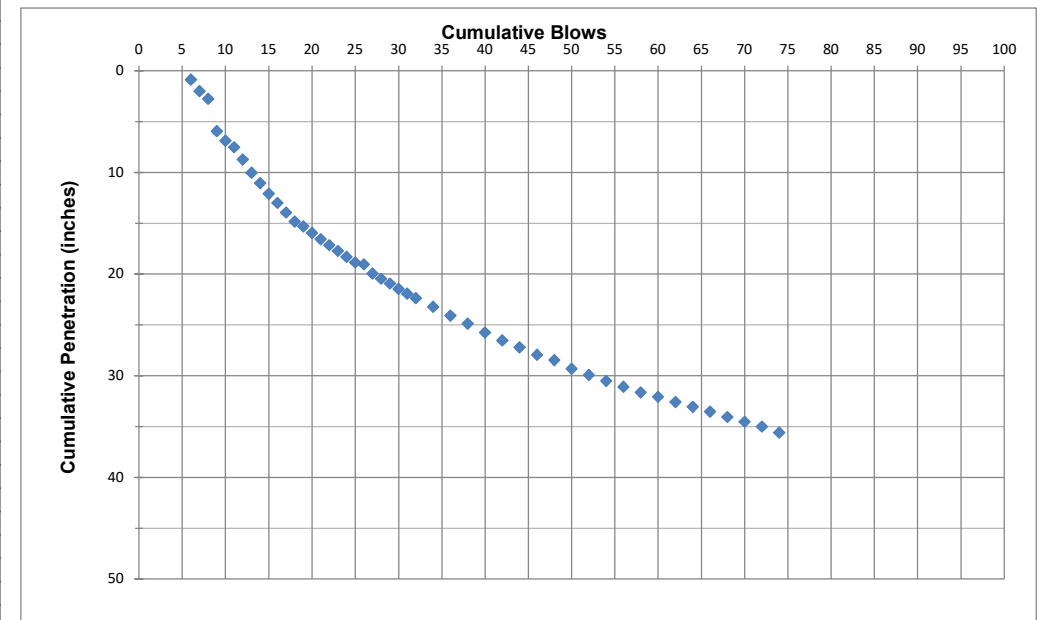

Location: Parkway Woods      Wilsonville      Date: 3/30/2020      Test Hole Number: B-6  
 Depth to bottom: 48.9      122.25      Dimension: N/A      Test Method: Dynamic Cone Penetration  
 Tester's Name: John Lawes                GeoEngineers Job: 23754-001-01  
 Tester's Company: GeoEngineers, Inc.      Tester's Contact No: 971-409-7390      Project Name: Parkway Woods Business Park  
 Notes: Driven from base of aggregate (~13" below pavement surface)

Depth, feet	Soil Texture
0-1.15	Asphalt Pavement/aggregate base
1.15-4.5	Light gray SILT to ELASTIC SILT
4.5-6.5	Gray SILTY fine SAND

Test increment	Number of blows	Cumulative blows	Depth below base of S-1	Penetration per increment	Cumulative penetration	Cummulative Penetration	Penetration per blow set	Penetration per blow	Hammer blow factor	DCP Index	DCP Index	CBR	M <sub>R</sub>
#	#	#	(in)	(mm)	(mm)	(in)	(in)	(in)	1 for 8-kg 2 for 4.6-kg hammer	in/blow	mm/blow	%	psi
1	1	6	2.4	60.0	60.0	2.4	2.4	2.36	1	2.36	60.00	3	3475
2	1	7	3.7	34.0	94.0	3.7	1.3	1.34	1	1.34	34.00	6	4337
3	1	8	5.2	37.0	131.0	5.2	1.5	1.46	1	1.46	37.00	5	4196
4	1	9	6.4	31.0	162.0	6.4	1.2	1.22	1	1.22	31.00	6	4496
5	1	10	7.3	24.0	186.0	7.3	0.9	0.94	1	0.94	24.00	8	4968
6	1	11	8.2	22.0	208.0	8.2	0.9	0.87	1	0.87	22.00	9	5140
7	1	12	8.9	19.0	227.0	8.9	0.7	0.75	1	0.75	19.00	11	5442
8	1	13	9.8	22.0	249.0	9.8	0.9	0.87	1	0.87	22.00	9	5140
9	1	14	10.6	21.0	270.0	10.6	0.8	0.83	1	0.83	21.00	10	5234
10	1	15	11.4	20.0	290.0	11.4	0.8	0.79	1	0.79	20.00	10	5334
11	1	16	12.2	20.0	310.0	12.2	0.8	0.79	1	0.79	20.00	10	5334
12	1	17	13.0	19.0	329.0	13.0	0.7	0.75	1	0.75	19.00	11	5442
13	1	18	13.6	17.0	346.0	13.6	0.7	0.67	1	0.67	17.00	12	5683
14	1	19	14.4	19.0	365.0	14.4	0.7	0.75	1	0.75	19.00	11	5442
15	1	20	15.0	17.0	382.0	15.0	0.7	0.67	1	0.67	17.00	12	5683
16	1	21	15.8	19.0	401.0	15.8	0.7	0.75	1	0.75	19.00	11	5442
17	1	22	16.5	19.0	420.0	16.5	0.7	0.75	1	0.75	19.00	11	5442
18	1	23	17.2	16.0	436.0	17.2	0.6	0.63	1	0.63	16.00	13	5819
19	1	24	17.9	18.0	454.0	17.9	0.7	0.71	1	0.71	18.00	11	5558
20	1	25	18.6	18.0	472.0	18.6	0.7	0.71	1	0.71	18.00	11	5558
21	1	26	19.3	17.0	489.0	19.3	0.7	0.67	1	0.67	17.00	12	5683
22	1	27	19.9	17.0	506.0	19.9	0.7	0.67	1	0.67	17.00	12	5683
23	1	28	20.2	6.0	512.0	20.2	0.2	0.24	1	0.24	6.00	39	8531
24	1	29	20.9	19.0	531.0	20.9	0.7	0.75	1	0.75	19.00	11	5442
25	1	30	21.8	23.0	554.0	21.8	0.9	0.91	1	0.91	23.00	9	5051
26	1	31	22.4	15.0	569.0	22.4	0.6	0.59	1	0.59	15.00	14	5967
27	1	32	23.0	15.0	584.0	23.0	0.6	0.59	1	0.59	15.00	14	5967
28	1	33	23.6	16.0	600.0	23.6	0.6	0.63	1	0.63	16.00	13	5819
29	1	34	24.2	15.0	615.0	24.2	0.6	0.59	1	0.59	15.00	14	5967
30	1	35	24.8	15.0	630.0	24.8	0.6	0.59	1	0.59	15.00	14	5967
31	1	36	25.4	16.0	646.0	25.4	0.6	0.63	1	0.63	16.00	13	5819
32	1	37	25.9	13.0	659.0	25.9	0.5	0.51	1	0.51	13.00	17	6310
33	1	38	26.1	4.0	663.0	26.1	0.2	0.16	1	0.16	4.00	62	9992
34	2	40	27.5	35.0	698.0	27.5	1.4	0.69	1	0.69	17.50	12	5619
35	2	42	28.5	25.0	723.0	28.5	1.0	0.49	1	0.49	12.50	17	6407
36	2	44	29.4	24.0	747.0	29.4	0.9	0.47	1	0.47	12.00	18	6510
37	2	46	30.3	23.0	770.0	30.3	0.9	0.45	1	0.45	11.50	19	6619
38	2	48	31.3	25.0	795.0	31.3	1.0	0.49	1	0.49	12.50	17	6407
39	2	50	32.1	20.0	815.0	32.1	0.8	0.39	1	0.39	10.00	22	6990
40	2	52	33.0	22.0	837.0	33.0	0.9	0.43	1	0.43	11.00	20	6735
41	2	54	33.7	19.0	856.0	33.7	0.7	0.37	1	0.37	9.50	23	7131
42	2	56	34.3	15.0	871.0	34.3	0.6	0.30	1	0.30	7.50	31	7820
43	2	58	35.2	24.0	895.0	35.2	0.9	0.47	1	0.47	12.00	18	6510
44	2	60	35.9	18.0	913.0	35.9	0.7	0.35	1	0.35	9.00	25	7283

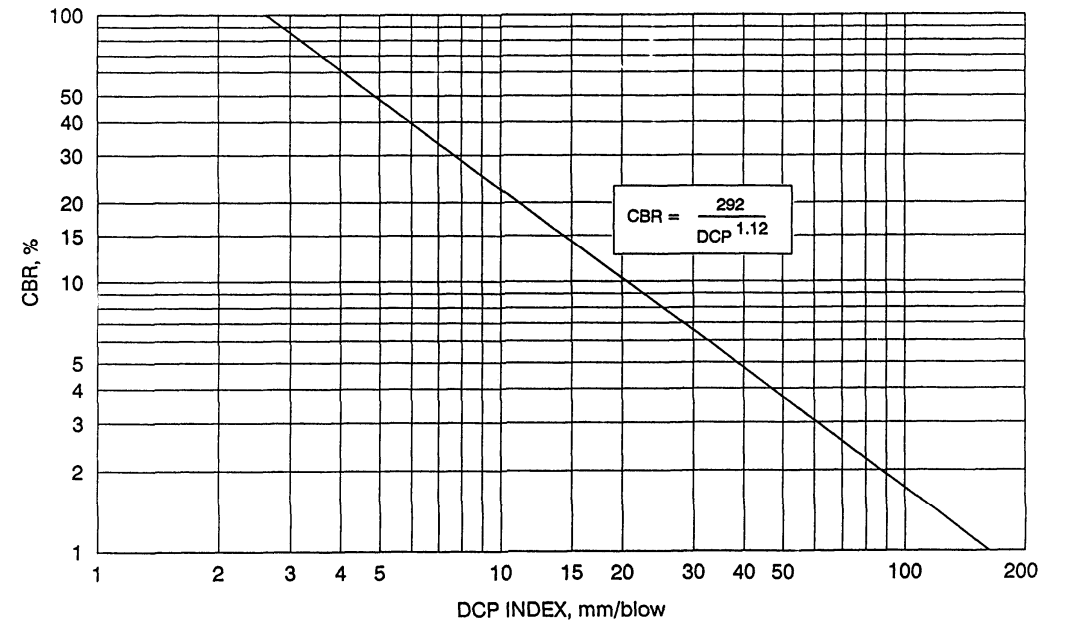

(after Webster et al., 1992)  
 Webster, S. L., Grau, R. H., and Williams, T. P. (1992). Description and application of dual mass dynamic cone penetrometer. Department of the Army Waterways Equipment Station, No. GL-92-3.

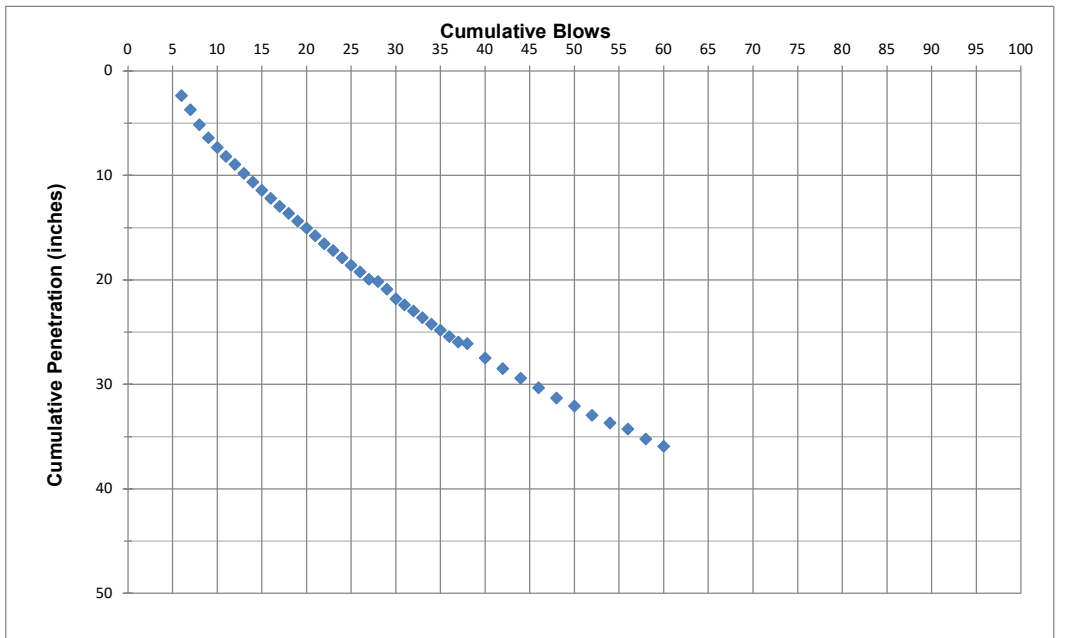

Location: Parkway Woods      Wilsonville      Date: 3/30/2020      Test Hole Number: B-7  
 Depth to bottom: 48.6      121.5      Dimension: N/A      Test Method: Dynamic Cone Penetration  
 Tester's Name: John Lawes                GeoEngineers Job: 23754-001-01  
 Tester's Company: GeoEngineers, Inc.      Tester's Contact No: 971-409-7390      Project Name: Parkway Woods Business Park  
 Notes: Driven from base of aggregate (~13" below pavement surface)

Depth, feet	Soil Texture
0-1.15	Asphalt Pavement/aggregate base
1.15-6.5	Light gray SILT to ELASTIC SILT
	Stiff to medium stiff

Test increment	Number of blows	Cumulative blows	Depth below base of S-1	Penetration per increment	Cumulative penetration	Cummulative Penetration	Penetration per blow set	Penetration per blow	Hammer blow factor	DCP Index	DCP Index	CBR	M <sub>R</sub>
#	#	#	(in)	(mm)	(mm)	(in)	(in)	(in)	1 for 8-kg 2 for 4.6-kg hammer	in/blow	mm/blow	%	psi
1	1	6	0.7	19.0	19.0	0.7	0.7	0.75	1	0.75	19.00	11	5442
2	1	7	1.3	14.0	33.0	1.3	0.6	0.55	1	0.55	14.00	15	6130
3	1	8	2.5	31.0	64.0	2.5	1.2	1.22	1	1.22	31.00	6	4496
4	1	9	3.6	27.0	91.0	3.6	1.1	1.06	1	1.06	27.00	7	4745
5	1	10	4.6	26.0	117.0	4.6	1.0	1.02	1	1.02	26.00	8	4815
6	1	11	5.2	16.0	133.0	5.2	0.6	0.63	1	0.63	16.00	13	5819
7	1	12	6.2	24.0	157.0	6.2	0.9	0.94	1	0.94	24.00	8	4968
8	1	13	6.9	18.0	175.0	6.9	0.7	0.71	1	0.71	18.00	11	5558
9	1	14	7.5	15.0	190.0	7.5	0.6	0.59	1	0.59	15.00	14	5967
10	1	15	8.0	13.0	203.0	8.0	0.5	0.51	1	0.51	13.00	17	6310
11	1	16	8.9	23.0	226.0	8.9	0.9	0.91	1	0.91	23.00	9	5051
12	1	17	9.6	19.0	245.0	9.6	0.7	0.75	1	0.75	19.00	11	5442
13	1	18	10.2	14.0	259.0	10.2	0.6	0.55	1	0.55	14.00	15	6130
14	1	19	10.8	16.0	275.0	10.8	0.6	0.63	1	0.63	16.00	13	5819
15	1	20	11.4	15.0	290.0	11.4	0.6	0.59	1	0.59	15.00	14	5967
16	1	21	11.8	9.0	299.0	11.8	0.4	0.35	1	0.35	9.00	25	7283
17	1	22	12.6	20.0	319.0	12.6	0.8	0.79	1	0.79	20.00	10	5334
18	1	23	13.1	13.0	332.0	13.1	0.5	0.51	1	0.51	13.00	17	6310
19	2	25	14.2	28.0	360.0	14.2	1.1	0.55	1	0.55	14.00	15	6130
20	2	27	15.1	24.0	384.0	15.1	0.9	0.47	1	0.47	12.00	18	6510
21	2	29	16.3	31.0	415.0	16.3	1.2	0.61	1	0.61	15.50	14	5892
22	2	31	17.4	27.0	442.0	17.4	1.1	0.53	1	0.53	13.50	16	6218
23	2	33	18.3	22.0	464.0	18.3	0.9	0.43	1	0.43	11.00	20	6735
24	2	35	19.6	33.0	497.0	19.6	1.3	0.65	1	0.65	16.50	13	5750
25	2	37	20.6	27.0	524.0	20.6	1.1	0.53	1	0.53	13.50	16	6218
26	2	39	21.6	25.0	549.0	21.6	1.0	0.49	1	0.49	12.50	17	6407
27	2	41	22.6	26.0	575.0	22.6	1.0	0.51	1	0.51	13.00	17	6310
28	2	43	23.5	22.0	597.0	23.5	0.9	0.43	1	0.43	11.00	20	6735
29	2	45	24.5	25.0	622.0	24.5	1.0	0.49	1	0.49	12.50	17	6407
30	2	47	25.4	22.0	644.0	25.4	0.9	0.43	1	0.43	11.00	20	6735
31	2	49	26.3	24.0	668.0	26.3	0.9	0.47	1	0.47	12.00	18	6510
32	2	51	27.2	22.0	690.0	27.2	0.9	0.43	1	0.43	11.00	20	6735
33	2	53	28.0	22.0	712.0	28.0	0.9	0.43	1	0.43	11.00	20	6735
34	2	55	28.8	20.0	732.0	28.8	0.8	0.39	1	0.39	10.00	22	6990
35	2	57	29.7	22.0	754.0	29.7	0.9	0.43	1	0.43	11.00	20	6735
36	2	59	30.4	18.0	772.0	30.4	0.7	0.35	1	0.35	9.00	25	7283
37	2	61	31.2	20.0	792.0	31.2	0.8	0.39	1	0.39	10.00	22	6990
38	2	63	32.0	20.0	812.0	32.0	0.8	0.39	1	0.39	10.00	22	6990
39	2	65	32.8	20.0	832.0	32.8	0.8	0.39	1	0.39	10.00	22	6990
40	2	67	33.5	20.0	852.0	33.5	0.8	0.39	1	0.39	10.00	22	6990
41	2	69	34.3	18.0	870.0	34.3	0.7	0.35	1	0.35	9.00	25	7283
42	2	71	34.9	17.0	887.0	34.9	0.7	0.33	1	0.33	8.50	27	7447
43	2	73	35.6	17.0	904.0	35.6	0.7	0.33	1	0.33	8.50	27	7447

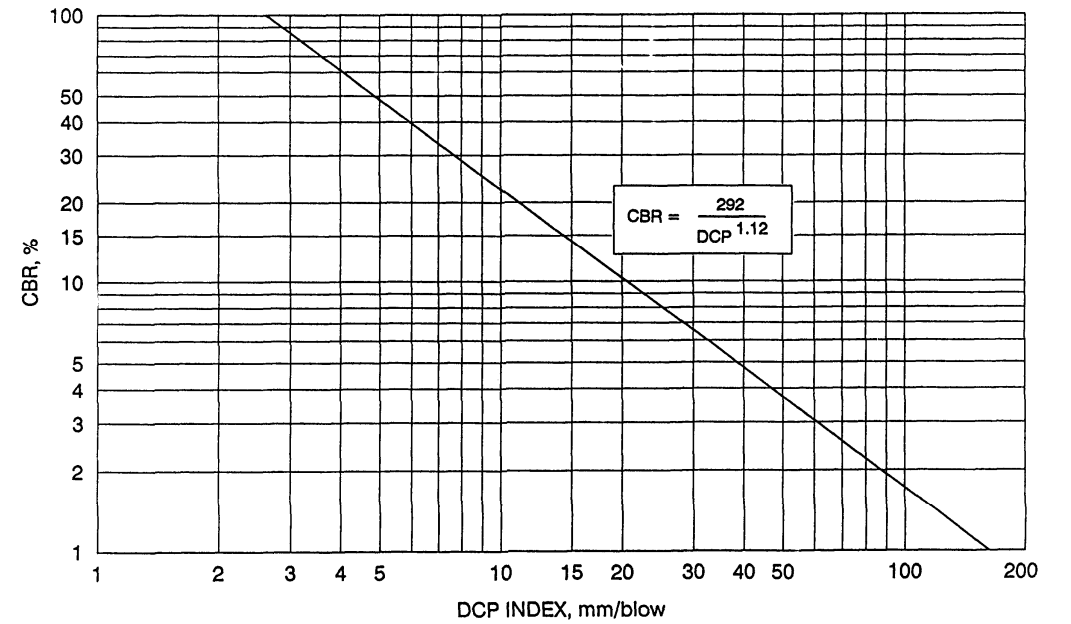

(after Webster et al., 1992)  
 Webster, S. L., Grau, R. H., and Williams, T. P. (1992). Description and application of dual mass dynamic cone penetrometer. Department of the Army Waterways Equipment Station, No. GL-92-3.

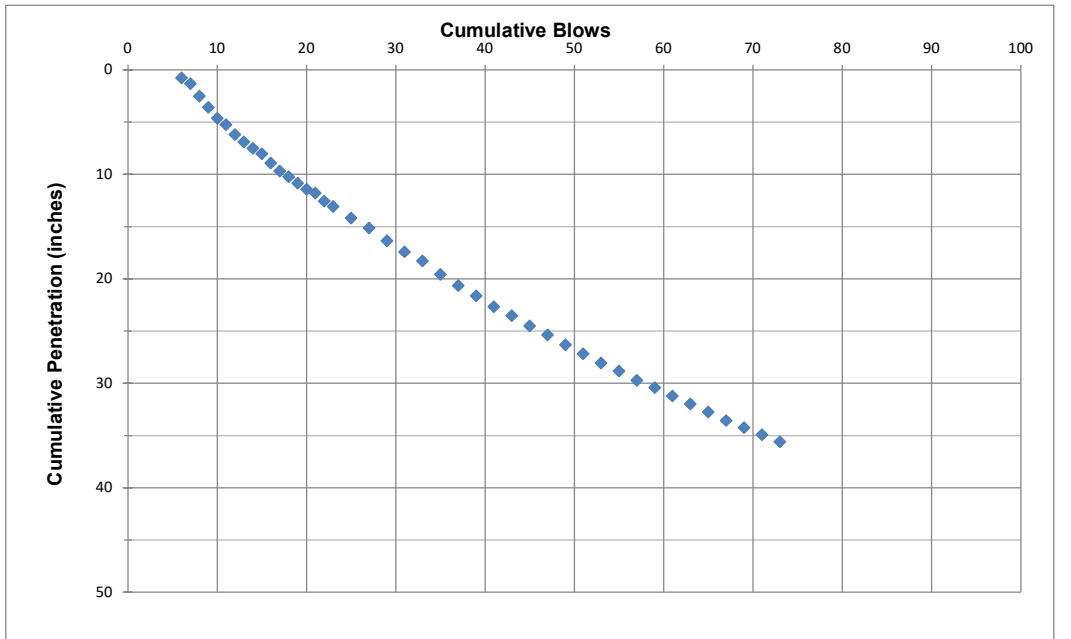

Location: Parkway Woods Wilsonville Date: 3/31/2020  
 Depth to bottom: 48.6 121.5 Dimension: N/A  
 Tester's Name: John Lawes  
 Tester's Company: GeoEngineers, Inc. Tester's Contact No: 971-409-7390  
 Notes: Driven from ground surface

Test Hole Number: HA-1  
 Test Method: Dynamic Cone Penetration  
 GeoEngineers Job: 23754-001-01  
 Project Name: Parkway Woods Business Park

Depth, feet	Soil Texture
0-1.15	Asphalt Pavement/aggregate base N/A
1.15-6.5	Light gray SILT to ELASTIC SILT Stiff to medium stiff

Test increment	Number of blows	Cumulative blows	Depth below base of S-1	Penetration per increment	Cumulative penetration	Cummulative Penetration	Penetration per blow set	Penetration per blow	Hammer blow factor	DCP Index	DCP Index	CBR	M <sub>R</sub>
#	#	#	(in)	(mm)	(mm)	(in)	(in)	(in)	1 for 8-kg 2 for 4.6-kg hammer	in/blow	mm/blow	%	psi
1	1	6	0.7	19.0	19.0	0.7	0.7	0.75	1	0.75	19.00	11	5442
2	1	7	1.3	14.0	33.0	1.3	0.6	0.55	1	0.55	14.00	15	6130
3	1	8	2.5	31.0	64.0	2.5	1.2	1.22	1	1.22	31.00	6	4496
4	1	9	3.6	27.0	91.0	3.6	1.1	1.06	1	1.06	27.00	7	4745
5	1	10	4.6	26.0	117.0	4.6	1.0	1.02	1	1.02	26.00	8	4815
6	1	11	5.2	16.0	133.0	5.2	0.6	0.63	1	0.63	16.00	13	5819
7	1	12	6.2	24.0	157.0	6.2	0.9	0.94	1	0.94	24.00	8	4968
8	1	13	6.9	18.0	175.0	6.9	0.7	0.71	1	0.71	18.00	11	5558
9	1	14	7.5	15.0	190.0	7.5	0.6	0.59	1	0.59	15.00	14	5967
10	1	15	8.0	13.0	203.0	8.0	0.5	0.51	1	0.51	13.00	17	6310
11	1	16	8.9	23.0	226.0	8.9	0.9	0.91	1	0.91	23.00	9	5051
12	1	17	9.6	19.0	245.0	9.6	0.7	0.75	1	0.75	19.00	11	5442
13	1	18	10.2	14.0	259.0	10.2	0.6	0.55	1	0.55	14.00	15	6130
14	1	19	10.8	16.0	275.0	10.8	0.6	0.63	1	0.63	16.00	13	5819
15	1	20	11.4	15.0	290.0	11.4	0.6	0.59	1	0.59	15.00	14	5967
16	1	21	11.8	9.0	299.0	11.8	0.4	0.35	1	0.35	9.00	25	7283
17	1	22	12.6	20.0	319.0	12.6	0.8	0.79	1	0.79	20.00	10	5334
18	1	23	13.1	13.0	332.0	13.1	0.5	0.51	1	0.51	13.00	17	6310
19	2	25	14.2	28.0	360.0	14.2	1.1	0.55	1	0.55	14.00	15	6130
20	2	27	15.1	24.0	384.0	15.1	0.9	0.47	1	0.47	12.00	18	6510
21	2	29	16.3	31.0	415.0	16.3	1.2	0.61	1	0.61	15.50	14	5892
22	2	31	17.4	27.0	442.0	17.4	1.1	0.53	1	0.53	13.50	16	6218
23	2	33	18.3	22.0	464.0	18.3	0.9	0.43	1	0.43	11.00	20	6735
24	2	35	19.6	33.0	497.0	19.6	1.3	0.65	1	0.65	16.50	13	5750
25	2	37	20.6	27.0	524.0	20.6	1.1	0.53	1	0.53	13.50	16	6218
26	2	39	21.6	25.0	549.0	21.6	1.0	0.49	1	0.49	12.50	17	6407
27	2	41	22.6	26.0	575.0	22.6	1.0	0.51	1	0.51	13.00	17	6310
28	2	43	23.5	22.0	597.0	23.5	0.9	0.43	1	0.43	11.00	20	6735
29	2	45	24.5	25.0	622.0	24.5	1.0	0.49	1	0.49	12.50	17	6407
30	2	47	25.4	22.0	644.0	25.4	0.9	0.43	1	0.43	11.00	20	6735
31	2	49	26.3	24.0	668.0	26.3	0.9	0.47	1	0.47	12.00	18	6510
32	2	51	27.2	22.0	690.0	27.2	0.9	0.43	1	0.43	11.00	20	6735
33	2	53	28.0	22.0	712.0	28.0	0.9	0.43	1	0.43	11.00	20	6735
34	2	55	28.8	20.0	732.0	28.8	0.8	0.39	1	0.39	10.00	22	6990
35	2	57	29.7	22.0	754.0	29.7	0.9	0.43	1	0.43	11.00	20	6735
36	2	59	30.4	18.0	772.0	30.4	0.7	0.35	1	0.35	9.00	25	7283
37	2	61	31.2	20.0	792.0	31.2	0.8	0.39	1	0.39	10.00	22	6990
38	2	63	32.0	20.0	812.0	32.0	0.8	0.39	1	0.39	10.00	22	6990
39	2	65	32.8	20.0	832.0	32.8	0.8	0.39	1	0.39	10.00	22	6990
40	2	67	33.5	20.0	852.0	33.5	0.8	0.39	1	0.39	10.00	22	6990
41	2	69	34.3	18.0	870.0	34.3	0.7	0.35	1	0.35	9.00	25	7283
42	2	71	34.9	17.0	887.0	34.9	0.7	0.33	1	0.33	8.50	27	7447
43	2	73	35.6	17.0	904.0	35.6	0.7	0.33	1	0.33	8.50	27	7447

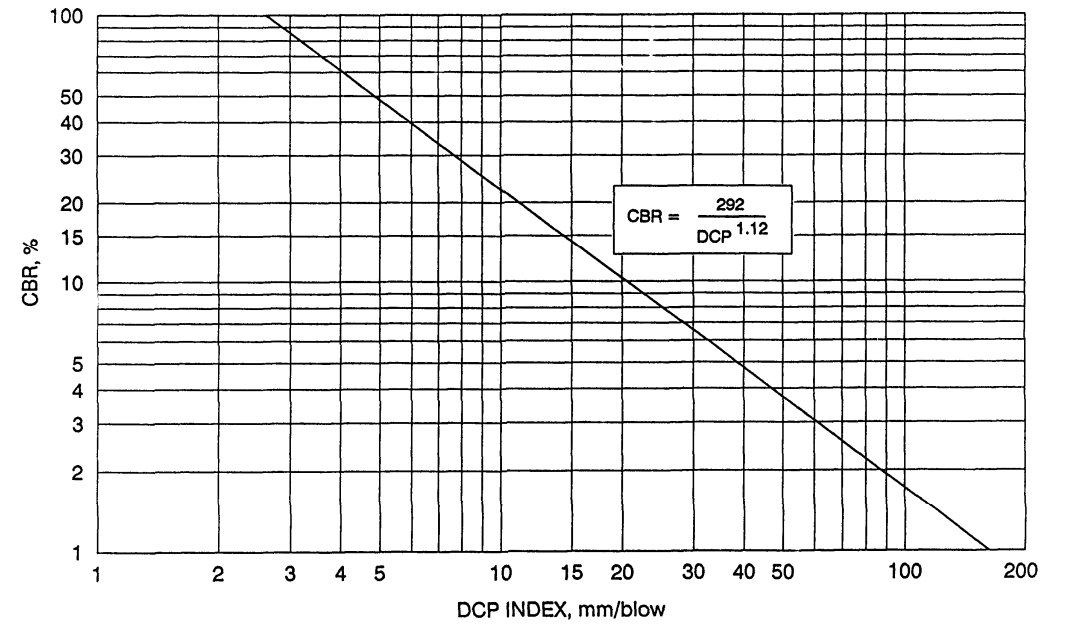

(after Webster et al., 1992)  
 Webster, S. L., Grau, R. H., and Williams, T. P. (1992). Description and application of dual mass dynamic cone penetrometer. Department of the Army Waterways Equipment Station, No. GL-92-3.

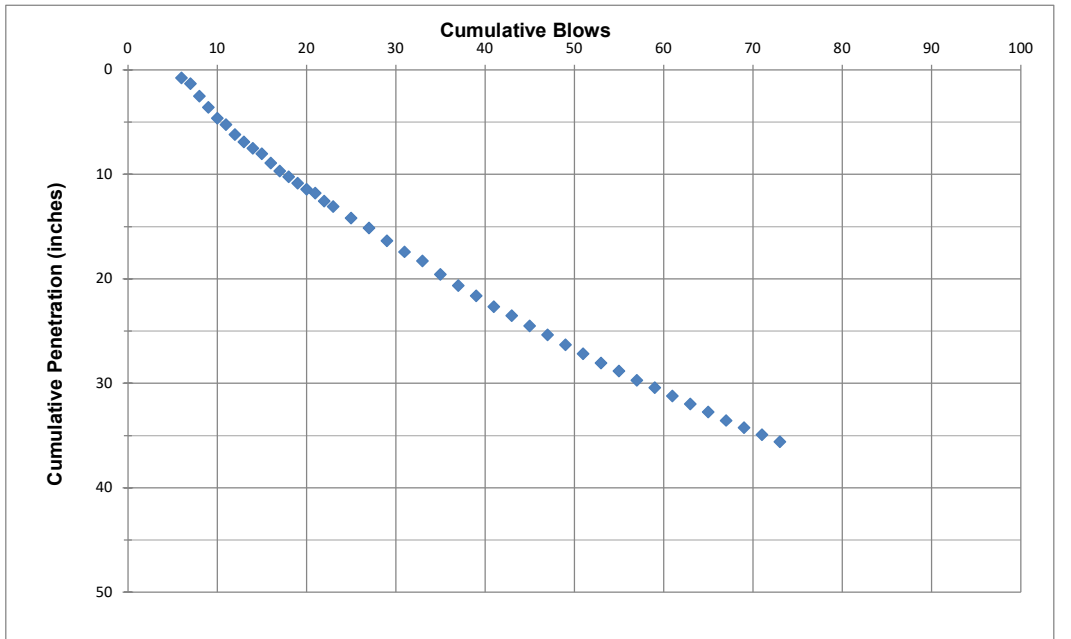



Location: Parkway Woods Wilsonville  
 Depth to bottom: 35 88.8  
 Tester's Name: John Lawes  
 Tester's Company: GeoEngineers, Inc.  
 Notes: Driven from ground surface

Date: 3/31/2020  
 Dimension: N/A  
 Tester's Contact No: 971-409-7390

Test Hole Number: HA-3  
 Test Method: Dynamic Cone Penetration  
 GeoEngineers Job: 23754-001-01  
 Project Name: Parkway Woods Business Park

Depth, feet	Soil Texture
0-3	SILT Medium stiff to stiff
3-3.5	SILTY GRAVEL Dense

Test increment	Number of blows	Cumulative blows	Depth below base of S-1	Penetration per increment	Cumulative penetration	Cummulative Penetration	Penetration per blow set	Penetration per blow	Hammer blow factor	DCP Index	DCP Index	CBR	M <sub>R</sub>
#	#	#	(in)	(mm)	(mm)	(in)	(in)	(in)	1 for 8-kg 2 for 4.6-kg hammer	in/blow	mm/blow	%	psi
1	1	6	2.3	58.0	58.0	2.3	2.3	2.28	1	2.28	58.00	3	3522
2	1	7	5.7	88.0	146.0	5.7	3.5	3.46	1	3.46	88.00	2	2993
3	1	8	8.0	56.0	202.0	8.0	2.2	2.20	1	2.20	56.00	3	3570
4	1	9	9.9	50.0	252.0	9.9	2.0	1.97	1	1.97	50.00	4	3731
5	1	10	12.1	55.0	307.0	12.1	2.2	2.17	1	2.17	55.00	3	3595
6	1	11	13.7	40.0	347.0	13.7	1.6	1.57	1	1.57	40.00	5	4071
7	1	12	14.5	21.0	368.0	14.5	0.8	0.83	1	0.83	21.00	10	5234
8	2	14	15.4	22.0	390.0	15.4	0.9	0.43	1	0.43	11.00	20	6735
9	1	15	16.8	37.0	427.0	16.8	1.5	1.46	1	1.46	37.00	5	4196
10	1	16	18.6	45.0	472.0	18.6	1.8	1.77	1	1.77	45.00	4	3888
11	1	17	20.5	48.0	520.0	20.5	1.9	1.89	1	1.89	48.00	4	3791
12	1	18	21.7	30.0	550.0	21.7	1.2	1.18	1	1.18	30.00	6	4554
13	1	19	22.6	24.0	574.0	22.6	0.9	0.94	1	0.94	24.00	8	4968
14	1	20	23.5	23.0	597.0	23.5	0.9	0.91	1	0.91	23.00	9	5051
15	1	21	24.3	20.0	617.0	24.3	0.8	0.79	1	0.79	20.00	10	5334
16	1	22	25.3	25.0	642.0	25.3	1.0	0.98	1	0.98	25.00	8	4890
17	1	23	26.3	26.0	668.0	26.3	1.0	1.02	1	1.02	26.00	8	4815
18	1	24	26.5	5.0	673.0	26.5	0.2	0.20	1	0.20	5.00	48	9159
19	1	25	27.9	36.0	709.0	27.9	1.4	1.42	1	1.42	36.00	5	4241
20	1	26	29.1	29.0	738.0	29.1	1.1	1.14	1	1.14	29.00	7	4615
21	1	27	30.2	30.0	768.0	30.2	1.2	1.18	1	1.18	30.00	6	4554
22	1	28	31.3	26.0	794.0	31.3	1.0	1.02	1	1.02	26.00	8	4815
23	1	29	32.2	23.0	817.0	32.2	0.9	0.91	1	0.91	23.00	9	5051
24	1	30	33.0	21.0	838.0	33.0	0.8	0.83	1	0.83	21.00	10	5234
25	1	31	33.4	10.0	848.0	33.4	0.4	0.39	1	0.39	10.00	22	6990
26	2	33	33.9	14.0	862.0	33.9	0.6	0.28	1	0.28	7.00	33	8033
27	2	35	34.2	6.0	868.0	34.2	0.2	0.12	1	0.12	3.00	85	11179
28	2	37	34.4	6.0	874.0	34.4	0.2	0.12	1	0.12	3.00	85	11179
29	2	39	34.6	6.0	880.0	34.6	0.2	0.12	1	0.12	3.00	85	11179
30	4	43	35.0	8.0	888.0	35.0	0.3	0.08	1	0.08	2.00	134	13094

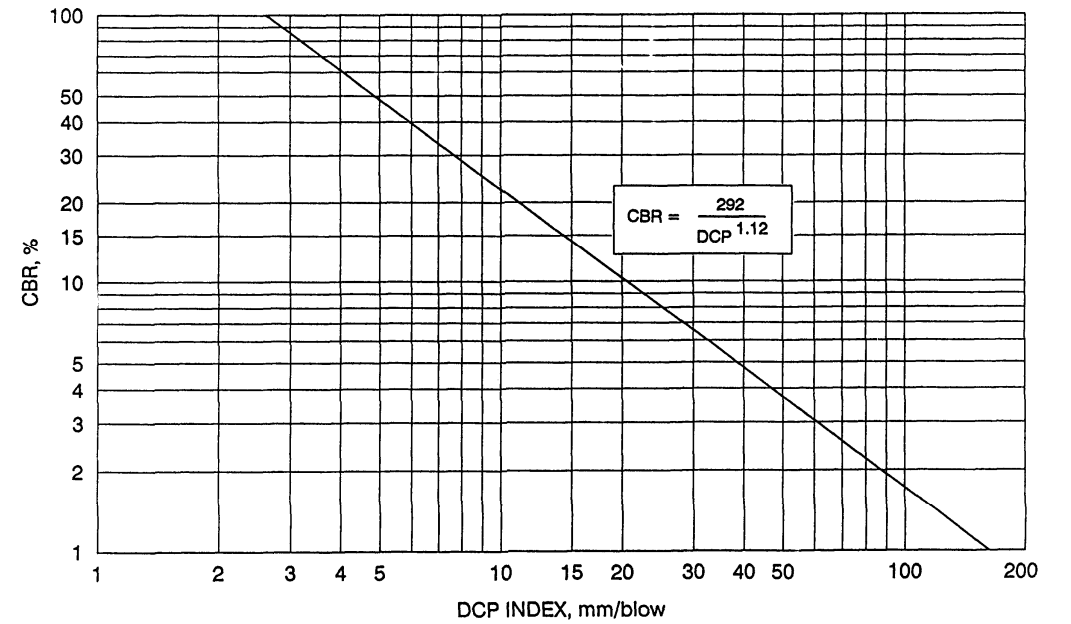

(after Webster et al., 1992)  
 Webster, S. L., Grau, R. H., and Williams, T. P. (1992). Description and application of dual mass dynamic cone penetrometer. Department of the Army Waterways Equipment Station, No. GL-92-3.

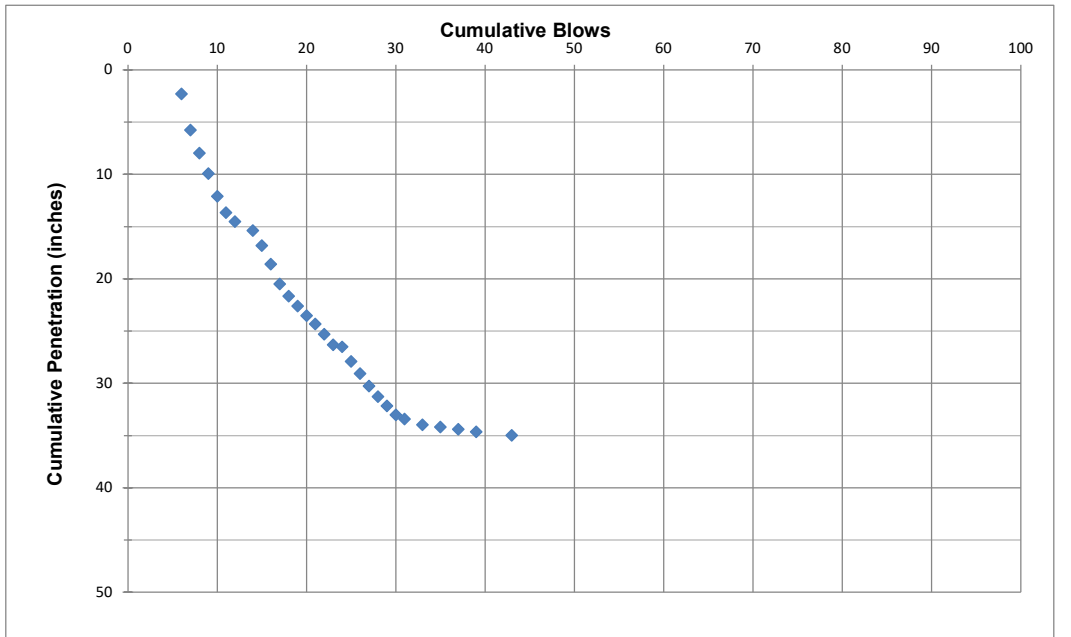

Location: Parkway Woods Wilsonville  
 Depth to bottom: 35 88.8  
 Tester's Name: John Lawes  
 Tester's Company: GeoEngineers, Inc.  
 Notes: Driven from ground surface

Date: 3/31/2020  
 Dimension: N/A  
 Tester's Contact No: 971-409-7390

Test Hole Number: HA-5  
 Test Method: Dynamic Cone Penetration  
 GeoEngineers Job: 23754-001-01  
 Project Name: Parkway Woods Business Park

Depth, feet	Soil Texture
0-7	SILT Medium stiff to stiff

Test increment	Number of blows	Cumulative blows	Depth below base of S-1	Penetration per increment	Cumulative penetration	Cummulative Penetration	Penetration per blow set	Penetration per blow	Hammer blow factor	DCP Index	DCP Index	CBR	M <sub>R</sub>
#	#	#	(in)	(mm)	(mm)	(in)	(in)	(in)	1 for 8-kg 2 for 4.6-kg hammer	in/blow	mm/blow	%	psi
1	1	6	5.7	144.0	144.0	5.7	5.7	5.67	1	5.67	144.00	1	2470
2	1	7	7.0	34.0	178.0	7.0	1.3	1.34	1	1.34	34.00	6	4337
3	1	8	8.1	27.0	205.0	8.1	1.1	1.06	1	1.06	27.00	7	4745
4	1	9	9.0	23.0	228.0	9.0	0.9	0.91	1	0.91	23.00	9	5051
5	1	10	10.1	28.0	256.0	10.1	1.1	1.10	1	1.10	28.00	7	4678
6	1	11	10.7	15.0	271.0	10.7	0.6	0.59	1	0.59	15.00	14	5967
7	1	12	13.1	63.0	334.0	13.1	2.5	2.48	1	2.48	63.00	3	3410
8	1	13	15.0	47.0	381.0	15.0	1.9	1.85	1	1.85	47.00	4	3823
9	1	14	16.6	41.0	422.0	16.6	1.6	1.61	1	1.61	41.00	5	4032
10	1	15	18.9	57.0	479.0	18.9	2.2	2.24	1	2.24	57.00	3	3545
11	1	16	20.7	46.0	525.0	20.7	1.8	1.81	1	1.81	46.00	4	3855
12	1	17	21.9	30.0	555.0	21.9	1.2	1.18	1	1.18	30.00	6	4554
13	1	18	22.7	22.0	577.0	22.7	0.9	0.87	1	0.87	22.00	9	5140
14	1	19	23.6	22.0	599.0	23.6	0.9	0.87	1	0.87	22.00	9	5140
15	1	20	24.6	27.0	626.0	24.6	1.1	1.06	1	1.06	27.00	7	4745
16	1	21	25.7	26.0	652.0	25.7	1.0	1.02	1	1.02	26.00	8	4815
17	1	22	26.6	23.0	675.0	26.6	0.9	0.91	1	0.91	23.00	9	5051
18	1	23	27.6	26.0	701.0	27.6	1.0	1.02	1	1.02	26.00	8	4815
19	1	24	28.5	23.0	724.0	28.5	0.9	0.91	1	0.91	23.00	9	5051
20	1	25	29.2	18.0	742.0	29.2	0.7	0.71	1	0.71	18.00	11	5558
21	1	26	30.0	20.0	762.0	30.0	0.8	0.79	1	0.79	20.00	10	5334
22	1	27	30.8	20.0	782.0	30.8	0.8	0.79	1	0.79	20.00	10	5334
23	1	28	31.5	17.0	799.0	31.5	0.7	0.67	1	0.67	17.00	12	5683
24	1	29	32.1	17.0	816.0	32.1	0.7	0.67	1	0.67	17.00	12	5683
25	2	31	33.0	23.0	839.0	33.0	0.9	0.45	1	0.45	11.50	19	6619
26	2	33	33.9	23.0	862.0	33.9	0.9	0.45	1	0.45	11.50	19	6619
27	2	35	34.7	19.0	881.0	34.7	0.7	0.37	1	0.37	9.50	23	7131
28	2	37	35.5	20.0	901.0	35.5	0.8	0.39	1	0.39	10.00	22	6990
29	2	39	36.2	18.0	919.0	36.2	0.7	0.35	1	0.35	9.00	25	7283

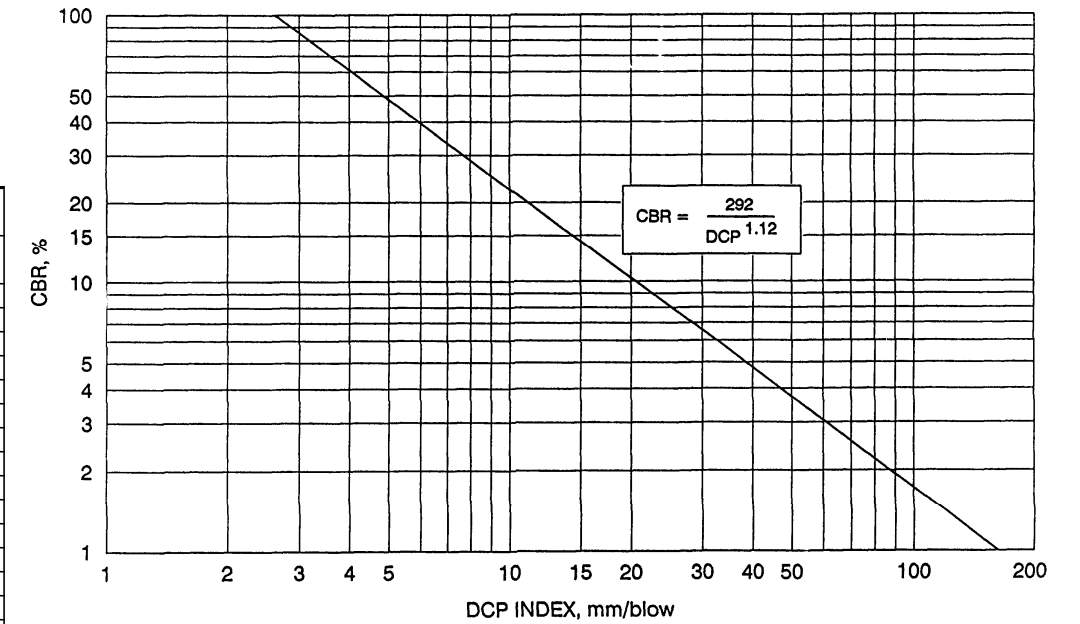



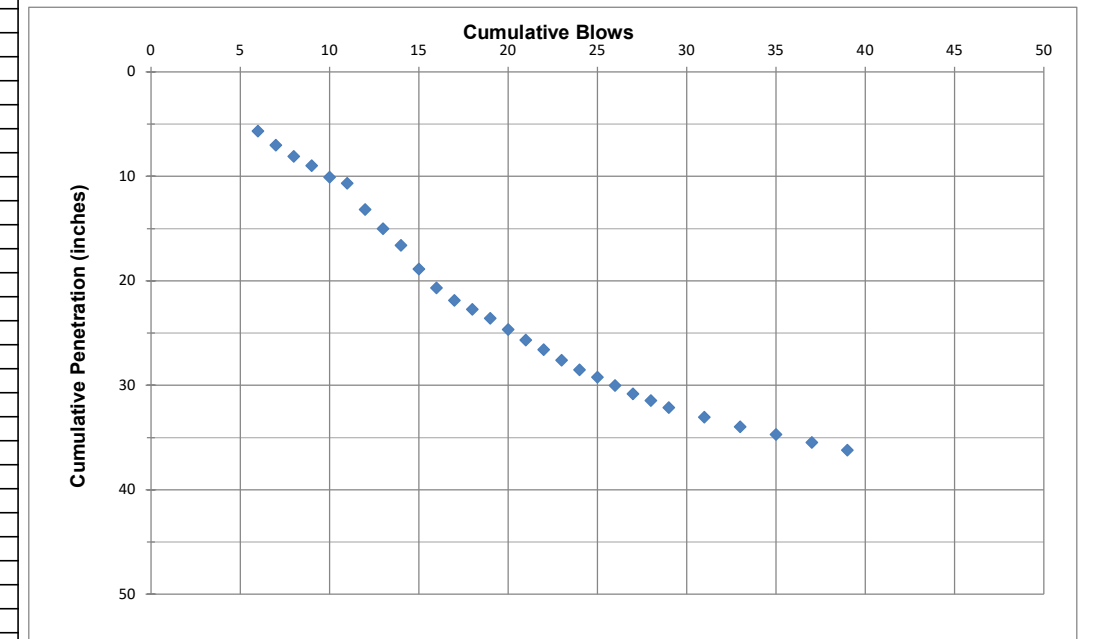











(after Webster et al., 1992)  
 Webster, S. L., Grau, R. H., and Williams, T. P. (1992). Description and application of dual mass dynamic cone penetrometer. Department of the Army Waterways Equipment Station, No. GL-92-3.









**APPENDIX B**  
**Boring Logs for Previous Geotechnical Report for the Site**

## SOIL CLASSIFICATION CHART

MAJOR DIVISIONS			SYMBOLS		TYPICAL DESCRIPTIONS
			GRAPH	LETTER	
COARSE GRAINED SOILS	GRAVEL AND GRAVELLY SOILS	CLEAN GRAVELS <small>(LITTLE OR NO FINES)</small>		<b>GW</b>	WELL-GRADED GRAVELS, GRAVEL - SAND MIXTURES
		GRAVELS WITH FINES <small>(APPRECIABLE AMOUNT OF FINES)</small>		<b>GP</b>	POORLY-GRADED GRAVELS, GRAVEL - SAND MIXTURES
		GRAVELS WITH FINES <small>(APPRECIABLE AMOUNT OF FINES)</small>		<b>GM</b>	SILTY GRAVELS, GRAVEL - SAND - SILT MIXTURES
	SAND AND SANDY SOILS	CLEAN SANDS <small>(LITTLE OR NO FINES)</small>		<b>GC</b>	CLAYEY GRAVELS, GRAVEL - SAND - CLAY MIXTURES
		CLEAN SANDS <small>(LITTLE OR NO FINES)</small>		<b>SW</b>	WELL-GRADED SANDS, GRAVELLY SANDS
		SANDS WITH FINES <small>(APPRECIABLE AMOUNT OF FINES)</small>		<b>SP</b>	POORLY-GRADED SANDS, GRAVELLY SAND
FINE GRAINED SOILS	SILTS AND CLAYS	SANDS WITH FINES <small>(APPRECIABLE AMOUNT OF FINES)</small>		<b>SM</b>	SILTY SANDS, SAND - SILT MIXTURES
		SANDS WITH FINES <small>(APPRECIABLE AMOUNT OF FINES)</small>		<b>SC</b>	CLAYEY SANDS, SAND - CLAY MIXTURES
		LIQUID LIMIT LESS THAN 50		<b>ML</b>	INORGANIC SILTS, ROCK FLOUR, CLAYEY SILTS WITH SLIGHT PLASTICITY
	SILTS AND CLAYS	LIQUID LIMIT LESS THAN 50		<b>CL</b>	INORGANIC CLAYS OF LOW TO MEDIUM PLASTICITY, GRAVELLY CLAYS, SANDY CLAYS, SILTY CLAYS, LEAN CLAYS
		LIQUID LIMIT LESS THAN 50		<b>OL</b>	ORGANIC SILTS AND ORGANIC SILTY CLAYS OF LOW PLASTICITY
		LIQUID LIMIT GREATER THAN 50		<b>MH</b>	INORGANIC SILTS, MICACEOUS OR DIATOMACEOUS SILTY SOILS
SILTS AND CLAYS	LIQUID LIMIT GREATER THAN 50		<b>CH</b>	INORGANIC CLAYS OF HIGH PLASTICITY	
	LIQUID LIMIT GREATER THAN 50		<b>OH</b>	ORGANIC CLAYS AND SILTS OF MEDIUM TO HIGH PLASTICITY	
	LIQUID LIMIT GREATER THAN 50		<b>PT</b>	PEAT, HUMUS, SWAMP SOILS WITH HIGH ORGANIC CONTENTS	

NOTE: Multiple symbols are used to indicate borderline or dual soil classifications

### Sampler Symbol Descriptions

	2.4-inch I.D. split barrel
	Standard Penetration Test (SPT)
	Shelby tube
	Piston
	Direct-Push
	Bulk or grab
	Continuous Coring





Blowcount is recorded for driven samplers as the number of blows required to advance sampler 12 inches (or distance noted). See exploration log for hammer weight and drop.

"P" indicates sampler pushed using the weight of the drill rig.

"WOH" indicates sampler pushed using the weight of the hammer.

NOTE: The reader must refer to the discussion in the report text and the logs of explorations for a proper understanding of subsurface conditions. Descriptions on the logs apply only at the specific exploration locations and at the time the explorations were made; they are not warranted to be representative of subsurface conditions at other locations or times.

## ADDITIONAL MATERIAL SYMBOLS

SYMBOLS		TYPICAL DESCRIPTIONS
GRAPH	LETTER	
	<b>AC</b>	Asphalt Concrete
	<b>CC</b>	Cement Concrete
	<b>CR</b>	Crushed Rock/Quarry Spalls
	<b>SOD</b>	Sod/Forest Duff
	<b>TS</b>	Topsoil

### Groundwater Contact



Measured groundwater level in exploration, well, or piezometer



Measured free product in well or piezometer

### Graphic Log Contact



Distinct contact between soil strata



Approximate contact between soil strata

### Material Description Contact



Contact between geologic units



Contact between soil of the same geologic unit

### Laboratory / Field Tests

%F	Percent fines
%G	Percent gravel
AL	Atterberg limits
CA	Chemical analysis
CP	Laboratory compaction test
CS	Consolidation test
DD	Dry density
DS	Direct shear
HA	Hydrometer analysis
MC	Moisture content
MD	Moisture density
Mohs	Mohs hardness scale
OC	Organic content
PM	Permeability or hydraulic conductivity
PI	Plasticity index
PP	Pocket penetrometer
SA	Sieve analysis
TX	Triaxial compression
UC	Unconfined compression
VS	Vane shear

### Sheen Classification

NS	No Visible Sheen
SS	Slight Sheen
MS	Moderate Sheen
HS	Heavy Sheen

## Key to Exploration Logs



Figure A-1

Start Drilled	11/17/2018	End	11/17/2018	Total Depth (ft)	6.5	Logged By	JLL	Checked By		Driller	Dan Fischer Excavating	Drilling Method	Solid-stem Auger
Surface Elevation (ft)	232			Vertical Datum	NAVD88	Hammer Data	Rope & cat head 140 (lbs) / 30 (in) Drop			Drilling Equipment	Buck Rogers 160 trailer		
Easting (X)	51839.75			Northing (Y)	5019345.29	System Datum	NAD83 (feet)			Groundwater not observed at time of exploration			
Notes:													

Elevation (feet)	FIELD DATA					Graphic Log	Group Classification	MATERIAL DESCRIPTION	Moisture Content (%)	Fines Content (%)	REMARKS
	Depth (feet)	Interval Recovered (in)	Blows/foot	Collected Sample	Sample Name Testing						
0							GM	Brown silty gravel with fine to medium sand (medium dense, moist) (fill)	9	19.7	
	14	11			1		MC		31		
			8				ML	Yellow-brown with red-brown mottling silt, trace fine sand (medium stiff, moist) (Willamette silt)	27		
5			9					Becomes stiff	27		IT-1 performed at 5 feet below ground surface

Note: See Figure A-1 for explanation of symbols.  
Coordinates Data Source: Horizontal approximated based on Google Earth. Vertical approximated based on Google Earth.

### Log of Boring B-1/IT-1



Project: Parkway Woods Business Park Parking  
Project Location: Wilsonville, Oregon  
Project Number: 23754-001-00

Figure A-2  
Sheet 1 of 1

Date: 12/20/18 Path: P:\23 23754-001\GINT\23754001.GPJ DBLlibrary\library\GEOENGINEERS\_DF\_STD\_US\_JUNE\_2017\GLB\GEB\GEO TECH\_STANDARD\_%F\_NO\_GW

Start Drilled	11/17/2018	End	11/17/2018	Total Depth (ft)	6.5	Logged By	JLL	Checked By		Driller	Dan Fischer Excavating	Drilling Method	Solid-stem Auger
Surface Elevation (ft) Vertical Datum	231 NAVD88			Hammer Data	Rope & cat head 140 (lbs) / 30 (in) Drop			Drilling Equipment	Buck Rogers 160 trailer				
Easting (X) Northing (Y)	518191.95 5019243.39			System Datum	NAD83 (feet)			Groundwater not observed at time of exploration					
Notes:													

Elevation (feet)	FIELD DATA					Graphic Log	Group Classification	MATERIAL DESCRIPTION	Moisture Content (%)	Fines Content (%)	REMARKS
	Depth (feet)	Interval Recovered (in)	Blows/foot	Collected Sample	Sample Name Testing						
0							ML	Gray-brown with red-brown mottling, occasional black silt, trace fine sand, fine roots (very stiff, moist) (fill) No roots at 5 inches			
230		16	17		1						
		14	20		2 MC				22		
5			8		3		ML	Gray with faint bronze mottling silt, trace fine sand (medium stiff, moist) (Willamette silt)			
225											IT-2 performed at 6 feet below ground surface

Note: See Figure A-1 for explanation of symbols.  
Coordinates Data Source: Horizontal approximated based on Google Earth. Vertical approximated based on Google Earth.

### Log of Boring B-2/IT-2



Project: Parkway Woods Business Park Parking  
Project Location: Wilsonville, Oregon  
Project Number: 23754-001-00

Figure A-3  
Sheet 1 of 1

Date: 12/20/18 Path: P:\23 23754-001\GINT\23754001.GPJ DBL\Library\Library\GEOENGINEERS\_DF\_STD\_US\_JUNE\_2017\GLB\GEB\GEO TECH\_STANDARD\_SF\_NO\_GW

Start Drilled	11/17/2018	End	11/17/2018	Total Depth (ft)	6.5	Logged By	JLL	Checked By		Driller	Dan Fischer Excavating	Drilling Method	Solid-stem Auger
Surface Elevation (ft) Vertical Datum	229 NAVD88			Hammer Data	Rope & cat head 140 (lbs) / 30 (in) Drop			Drilling Equipment	Buck Rogers 160 trailer				
Easting (X) Northing (Y)	518245.97 5019250.38			System Datum	NAD83 (feet)			Groundwater not observed at time of exploration					
Notes:													

Elevation (feet)	FIELD DATA					Graphic Log	Group Classification	MATERIAL DESCRIPTION	Moisture Content (%)	Fines Content (%)	REMARKS
	Depth (feet)	Interval Recovered (in)	Blows/foot	Collected Sample	Sample Name Testing						
0	12	7		1	MC		ML	Dark brown silt, trace fine sand and fine roots (medium stiff, moist) (fill)	24		
22.5	12	9		2	MC		ML	Gray-brown with red-brown mottling silt with fine sand (stiff, moist) (Willamette silt)	11		
5	16	16		3	MC			Becomes gray-brown to yellow-brown with red-brown mottling, trace fine sand (very stiff, moist)	33		

Note: See Figure A-1 for explanation of symbols.  
Coordinates Data Source: Horizontal approximated based on Google Earth. Vertical approximated based on Google Earth.

### Log of Boring B-3



Project: Parkway Woods Business Park Parking  
Project Location: Wilsonville, Oregon  
Project Number: 23754-001-00

Figure A-4  
Sheet 1 of 1

Date: 12/20/18 Path: P:\23 23754-001\GINT\23754001.GPJ DBLlibrary\library\GEOENGINEERS\_DF\_STD\_US\_JUNE\_2017\GLB\GEB\GEO TECH\_STANDARD\_SF\_NO\_GW

Start Drilled	11/17/2018	End	11/17/2018	Total Depth (ft)	6.5	Logged By	JLL	Checked By		Driller	Dan Fischer Excavating	Drilling Method	Solid-stem Auger
Surface Elevation (ft) Vertical Datum	289 NAVD88			Hammer Data	Rope & cat head 140 (lbs) / 30 (in) Drop			Drilling Equipment	Buck Rogers 160 trailer				
Easting (X) Northing (Y)	518293.28 501928.18			System Datum	NAD83 (feet)			Groundwater not observed at time of exploration					
Notes:													

Elevation (feet)	FIELD DATA					Graphic Log	Group Classification	MATERIAL DESCRIPTION	Moisture Content (%)	Fines Content (%)	REMARKS
	Depth (feet)	Interval Recovered (in)	Blows/foot	Collected Sample	Sample Name Testing						
0	9	10		1		ML	Dark gray-brown silt, fine roots to 4 to 5 feet, trace fine sand, (stiff, moist) (Willamette silt)				
							Grades to brown				
	10	19		2 AL		CH	Gray-brown clay (very stiff, moist)	19		AL = (LL = 62, PL = 31, PI = 31)	
							Becomes gray-brown with red-brown mottling, very stiff				
5		22		3		ML	Multicolored (yellow-brown, red-brown, and black) silt with fine sand (very stiff, moist)				

Note: See Figure A-1 for explanation of symbols.  
Coordinates Data Source: Horizontal approximated based on Google Earth. Vertical approximated based on Google Earth.

### Log of Boring B-4



Project: Parkway Woods Business Park Parking  
Project Location: Wilsonville, Oregon  
Project Number: 23754-001-00

Figure A-5  
Sheet 1 of 1

Date: 12/20/18 Path: P:\23 23754-001\GINT\23754001.GPJ DBL\Library\Library\GEOENGINEERS\_DF\_STD\_US\_JUNE\_2017\GLB\GEB\GEO TECH\_STANDARD\_SF\_NO\_GW



Start Drilled	11/17/2018	End	11/17/2018	Total Depth (ft)	6.5	Logged By	JLL	Checked By		Driller	Dan Fischer Excavating	Drilling Method	Solid-stem Auger
Surface Elevation (ft) Vertical Datum	227 NAVD88			Hammer Data	Rope & cat head 140 (lbs) / 30 (in) Drop			Drilling Equipment	Buck Rogers 160 trailer				
Easting (X) Northing (Y)	518240.17 5019163.94			System Datum	NAD83 (feet)			Groundwater not observed at time of exploration					
Notes:													

Elevation (feet)	FIELD DATA					Graphic Log	Group Classification	MATERIAL DESCRIPTION	Moisture Content (%)	Fines Content (%)	REMARKS
	Depth (feet)	Interval Recovered (in)	Blows/foot	Collected Sample	Sample Name Testing						
0	12	8		1 MC		ML	Dark brown silt, fine roots to 3 to 4 inches (medium stiff, moist) (Willamette silt)	21			
225	14	14		2 MC			Grades to yellow-brown, occasional charcoal fragments	36			
5	16	9		3 MC			Becomes mottled red-brown, stiff	29			

Note: See Figure A-1 for explanation of symbols.  
Coordinates Data Source: Horizontal approximated based on Google Earth. Vertical approximated based on Google Earth.

### Log of Boring B-5



Project: Parkway Woods Business Park Parking  
Project Location: Wilsonville, Oregon  
Project Number: 23754-001-00

Date: 12/20/18 Path: P:\23 23754001\GINT\23754001.GPJ DBLlibrary\library\GEOENGINEERS\_DF\_STD\_US\_JUNE\_2017\GLB\GEB\GEO TECH\_STANDARD\_SF\_NO\_GW

Start Drilled	11/17/2018	End	11/17/2018	Total Depth (ft)	6.5	Logged By	JLL	Checked By		Driller	Dan Fischer Excavating	Drilling Method	Solid-stem Auger
Surface Elevation (ft)	229			Vertical Datum	NAVD88	Hammer Data	Rope & cat head 140 (lbs) / 30 (in) Drop			Drilling Equipment	Buck Rogers 160 trailer		
Easting (X)	518182.29			System Datum	NAD83 (feet)	Groundwater not observed at time of exploration							
Northing (Y)	5019081.68												
Notes:													

Elevation (feet)	FIELD DATA					Graphic Log	Group Classification	MATERIAL DESCRIPTION	Moisture Content (%)	Fines Content (%)	REMARKS
	Depth (feet)	Interval Recovered (in)	Blows/foot	Collected Sample	Sample Name Testing						
0							ML	Dark brown silt, dark brown trace fine sand and fine roots to 4 to 6 feet (very stiff, moist) (Willamette silt)			
	12	21			1			Becomes brown with red-brown mottling			
	14	25			2 MC				17		
5			15		3 MC				15		IT-3 performed at 3 feet 8 inches below ground surface

Note: See Figure A-1 for explanation of symbols.  
Coordinates Data Source: Horizontal approximated based on Google Earth. Vertical approximated based on Google Earth.

### Log of Boring B-6/IT-3



Project: Parkway Woods Business Park Parking  
Project Location: Wilsonville, Oregon  
Project Number: 23754-001-00

Date: 12/20/18 Path: P:\23 23754001\GINT\23754001.GPJ DBLlibrary\library\GEOENGINEERS\_DF\_STD\_US\_JUNE\_2017\GLB\GEB\GEO TECH\_STANDARD\_%F\_NO\_GW

Drilled	Start 12/7/2018	End 12/7/2018	Total Depth (ft)	26.5	Logged By Checked By	DMH	Driller	Western States	Drilling Method	Hollow-stem Auger	
Surface Elevation (ft) Vertical Datum		Undetermined NAVD88			Hammer Data		Autohammer 140 (lbs) / 30 (in) Drop		Drilling Equipment		CME-75 Truck Rig
Easting (X) Northing (Y)				System Datum		NAD83 (feet)		See "Remarks" section for groundwater observed			
Notes:											

Elevation (feet)	FIELD DATA					Graphic Log	Group Classification	MATERIAL DESCRIPTION	Moisture Content (%)	Fines Content (%)	REMARKS
	Depth (feet)	Interval Recovered (in)	Blows/foot	Collected Sample	Sample Name Testing						
0							GM	Brown silty gravel with sand (medium dense, moist) (fill)			
							ML	Brown silt with occasional fine sand (medium stiff, moist) (Willamette Silt)			
5							CL	Brown-red clay with occasional fine sand (medium stiff, wet)			Groundwater observed at approximately 5 feet below ground surface 20 minutes after drilling
10	18	6	1				Becomes stiff				
15	18	14	2				Becomes very stiff				
20	18	17	3				Becomes stiff				
25	18	11	4				Becomes medium stiff to stiff				
	18	9	5				Becomes stiff				
	18	8	6				Becomes stiff				
	18	12	7				Becomes stiff				

Note: See Figure A-1 for explanation of symbols.  
Coordinates Data Source: Horizontal approximated based on Google Earth. Vertical approximated based on Google Earth.

### Log of Boring B-7



Project: Parkway Woods Business Park Parking  
Project Location: Wilsonville, Oregon  
Project Number: 23754-001-00

Figure A-8  
Sheet 1 of 1

Date: 12/20/18 Path: P:\23 23754-001\GINT\23754001.GPJ DBL\Library\Library\GEOENGINEERS\_DF\_STD\_US\_JUNE\_2017\GLB\GEIB\_GEO TECH\_STANDARD\_SF\_NO\_GW

**APPENDIX C**  
**Report Limitations and Guidelines for Use**

## **APPENDIX C REPORT LIMITATIONS AND GUIDELINES FOR USE<sup>1</sup>**

This appendix provides information to help you manage your risks with respect to the use of this report.

### **Read These Provisions Closely**

It is important to recognize that the geoscience practices (geotechnical engineering, geology and environmental science) rely on professional judgment and opinion to a greater extent than other engineering and natural science disciplines, where more precise and/or readily observable data may exist. To help clients better understand how this difference pertains to our services, GeoEngineers includes the following explanatory “limitations” provisions in its reports. Please confer with GeoEngineers if you need to know more how these “Report Limitations and Guidelines for Use” apply to your project or site.

### **Geotechnical Services Are Performed for Specific Purposes, Persons and Projects**

This report has been prepared for SkanlanKemperBard, LLC, Atwell, Inc., and their agents for the Project specifically identified in the report. The information contained herein is not applicable to other sites or projects.

GeoEngineers structures its services to meet the specific needs of its clients. No party other than the party to whom this report is addressed may rely on the product of our services unless we agree to such reliance in advance and in writing. Within the limitations of the agreed scope of services for the Project, and its schedule and budget, our services have been executed in accordance with our Agreement with SkanlanKemperBard LLC, dated January 23, 2020, and generally accepted geotechnical practices in this area at the time this report was prepared. We do not authorize, and will not be responsible for, the use of this report for any purposes or projects other than those identified in the report.

### **A Geotechnical Engineering or Geologic Report is Based on a Unique Set of Project-Specific Factors**

This report has been prepared for the proposed Parkway Woods Business Park – Parking and New Buildings Project in Wilsonville, Oregon. GeoEngineers considered a number of unique, project-specific factors when establishing the scope of services for this project and report. Unless GeoEngineers specifically indicates otherwise, it is important not to rely on this report if it was:

- not prepared for you,
- not prepared for your project,
- not prepared for the specific site explored, or
- completed before important project changes were made.

For example, changes that can affect the applicability of this report include those that affect:

- the function of the proposed structure;

---

<sup>1</sup> Developed based on material provided by ASFE, Professional Firms Practicing in the Geosciences; [www.asfe.org](http://www.asfe.org).

- elevation, configuration, location, orientation or weight of the proposed structure;

If changes occur after the date of this report, GeoEngineers cannot be responsible for any consequences of such changes in relation to this report unless we have been given the opportunity to review our interpretations and recommendations. Based on that review, we can provide written modifications or confirmation, as appropriate.

### **Environmental Concerns Are Not Covered**

Unless environmental services were specifically included in our scope of services, this report does not provide any environmental findings, conclusions, or recommendations, including but not limited to, the likelihood of encountering underground storage tanks or regulated contaminants.

### **Subsurface Conditions Can Change**

This geotechnical or geologic report is based on conditions that existed at the time the study was performed. The findings and conclusions of this report may be affected by the passage of time, by man-made events such as construction on or adjacent to the site, new information or technology that becomes available subsequent to the report date, or by natural events such as floods, earthquakes, slope instability or groundwater fluctuations. If more than a few months have passed since issuance of our report or work product, or if any of the described events may have occurred, please contact GeoEngineers before applying this report for its intended purpose so that we may evaluate whether changed conditions affect the continued reliability or applicability of our conclusions and recommendations.

### **Geotechnical and Geologic Findings Are Professional Opinions**

Our interpretations of subsurface conditions are based on field observations from widely spaced sampling locations at the site. Site exploration identifies the specific subsurface conditions only at those points where subsurface tests are conducted, or samples are taken. GeoEngineers reviewed field and laboratory data and then applied its professional judgment to render an informed opinion about subsurface conditions at other locations. Actual subsurface conditions may differ, sometimes significantly, from the opinions presented in this report. Our report, conclusions and interpretations are not a warranty of the actual subsurface conditions.

### **Geotechnical Engineering Report Recommendations Are Not Final**

We have developed the following recommendations based on data gathered from subsurface investigation(s). These investigations sample just a small percentage of a site to create a snapshot of the subsurface conditions elsewhere on the site. Such sampling on its own cannot provide a complete and accurate view of subsurface conditions for the entire site. Therefore, the recommendations included in this report are preliminary and should not be considered final. GeoEngineers' recommendations can be finalized only by observing actual subsurface conditions revealed during construction. GeoEngineers cannot assume responsibility or liability for the recommendations in this report if we do not perform construction observation.

We recommend that you allow sufficient monitoring, testing and consultation during construction by GeoEngineers to confirm that the conditions encountered are consistent with those indicated by the explorations, to provide recommendations for design changes if the conditions revealed during the work differ from those anticipated, and to evaluate whether earthwork activities are completed in accordance with our recommendations. Retaining GeoEngineers for construction observation for this project is the most

effective means of managing the risks associated with unanticipated conditions. If another party performs field observation and confirms our expectations, the other party must take full responsibility for both the observations and recommendations. Please note, however, that another party would lack our project-specific knowledge and resources.

### **A Geotechnical Engineering or Geologic Report Could Be Subject to Misinterpretation**

Misinterpretation of this report by members of the design team or by contractors can result in costly problems. GeoEngineers can help reduce the risks of misinterpretation by conferring with appropriate members of the design team after submitting the report, reviewing pertinent elements of the design team's plans and specifications, participating in pre-bid and preconstruction conferences, and providing construction observation.

### **Do Not Redraw the Exploration Logs**

Geotechnical engineers and geologists prepare final boring and testing logs based upon their interpretation of field logs and laboratory data. The logs included in a geotechnical engineering or geologic report should never be redrawn for inclusion in architectural or other design drawings. Photographic or electronic reproduction is acceptable, but separating logs from the report can create a risk of misinterpretation.

### **Give Contractors a Complete Report and Guidance**

To help reduce the risk of problems associated with unanticipated subsurface conditions, GeoEngineers recommends giving contractors the complete geotechnical engineering or geologic report, including these "Report Limitations and Guidelines for Use." When providing the report, you should preface it with a clearly written letter of transmittal that:

- advises contractors that the report was not prepared for purposes of bid development and that its accuracy is limited; and
- encourages contractors to confer with GeoEngineers and/or to conduct additional study to obtain the specific types of information they need or prefer.

### **Contractors Are Responsible for Site Safety on Their Own Construction Projects**

Our geotechnical recommendations are not intended to direct the contractor's procedures, methods, schedule or management of the work site. The contractor is solely responsible for job site safety and for managing construction operations to minimize risks to on-site personnel and adjacent properties.

### **Biological Pollutants**

GeoEngineers' Scope of Work specifically excludes the investigation, detection, prevention or assessment of the presence of Biological Pollutants. Accordingly, this report does not include any interpretations, recommendations, findings or conclusions regarding the detecting, assessing, preventing or abating of Biological Pollutants, and no conclusions or inferences should be drawn regarding Biological Pollutants as they may relate to this project. The term "Biological Pollutants" includes, but is not limited to, molds, fungi, spores, bacteria and viruses, and/or any of their byproducts.

A Client that desires these specialized services is advised to obtain them from a consultant who offers services in this specialized field.





**Parkway Woods Industrial  
Preliminary  
Stormwater Management Plan**

**Job No. 19004599  
Land Use: 2020-xxxx**

**Prepared for:**

Owner:  
**Scanlan Kemper Bard**  
26600 SW Parkway Ave.  
Wilsonville, Clackamas Co., Oregon, 97070

Prepared by:

**Atwell, LLC**  
9755 SW Barnes Road, Suite 150  
Portland, OR 97225  
Brady L. Berry, P.E.

May 14, 2020  
Rev 1 – June 29, 2020  
Rev 2 -





**Parkway Woods Industrial  
Preliminary Stormwater Management Plan  
TABLE OF CONTENTS**

1.0	INTRODUCTION/PROJECT DESCRIPTION.....	1
1.1	PROJECT ADDRESS.....	1
1.2	GENERAL TOPOGRAPHY AND GENERAL HYDROLOGY .....	1
2.0	EXISTING CONDITIONS .....	1
3.0	ON-SITE ANALYSIS .....	3
3.1	EXISTING ON-SITE FLOW CHARACTERISTICS.....	3
3.2	IMPERVIOUS AREAS .....	3
3.3	METHODOLOGY AND CRITERIA .....	4
3.4	GROWING MEDIUM .....	6
3.5	SITE ULTIMATE OUTFALL .....	7
4.0	CONSTRUCTION EROSION CONTROL.....	7
5.0	OPERATION AND MAINTENANCE.....	7
6.0	SUMMARY AND CONCLUSIONS .....	7
7.0	REFERENCES .....	8

## APPENDIX A

VICINITY MAP  
TOPOGRAPHIC SURVEY/EXISTING CONDITIONS  
SOIL INFORMATION  
INFILTRATION TESTING INFORMATION

## APPENDIX B

PRE-DEVELOPMENT BASIN MAP  
POST DEVELOPMENT BASIN MAP

## APPENDIX C

SLOPES – STORMWATER INFORMATION FORM  
WES BMP SIZING REPORT  
STORMFILTER CATCH BASIN CALCULATIONS

## APPENDIX D

BMP INFORMATION  
WILSONVILLE STANDARD DETAILS  
GROWING MEDIUM CUT SHEETS  
GROWING MEDIUM SPECIFICATIONS  
OPERATION AND MAINTENANCE SCHEDULE

## APPENDIX E

GRADING AND DRAINAGE PLAN

## **1.0 INTRODUCTION/PROJECT DESCRIPTION**

Scanlan Kemper Bard (SKB) is the owner of an existing industrial property (Tax Lot 0301W12 00511 & 00581) in Wilsonville Oregon. The project is to repurpose the existing building to provide for additional tenants in the existing building footprint. This includes adding additional loading docks and reconfiguring the parking to allow for better access to the reconfigured building. The reconfiguration requires additional impervious area as well as filling a minor wetland to the south of the existing building.

The City of Wilsonville 2015 Stormwater & Surface Water Design & Construction Standards will be used as the basis of design for redevelopment.

The project requires a joint United States Army Corps of Engineers (Corp)/Department of State Lands (DSL) fill permit to fill the isolated wetland to the south of the building which triggers the stormwater requirements under The Standard Local Operating Procedures for Endangered Species (SLOPES V) and Oregon DEQ 401 Certification.

### **1.1 PROJECT ADDRESS**

The property is located at 26600 SW Parkway Avenue, Wilsonville, Clackamas County, Oregon, 97070.

### **1.2 GENERAL TOPOGRAPHY AND GENERAL HYDROLOGY**

The area generally slopes to the southeast and the storm water is collected in a private piped stormwater network and routed to the South Tributary to Boeckman Creek south of the property.

## **2.0 EXISTING CONDITIONS**

The property is currently a developed industrial area with a large industrial building and supporting parking areas and infrastructure.

### Topography:

The site is relatively flat with elevations from 225 to 235 and a building finish floor of elevation 236. Previous development work has created discrete basins for collection and removal of stormwater to the south of the property.

Land Cover and Land Use:

The property is currently covered with a large footprint building (387,453 SF), paved parking areas (545,287 SF), a paved path network, landscaping, natural grass areas and a large number of trees. The property is currently utilized as an industrial campus.

Abutting Uses:

The property is surrounded by properties of similar Planned Development Industrial (PDI) zoning.

Offsite Drainage:

The property has a drainage on the easterly edge of the property (South Tributary to Boeckman Creek) that drains property to the north.

The property accepts drainage through the on-site underground storm sewer system from the property to the north that was once part of this tax lot. It crosses underneath Printer Parkway on the west side of the subject property.

Natural and Constructed Channels:

As described above, the site has an existing channel that is on the east side of the property. No new drainage channels are proposed with this redevelopment.

Wetlands:

A wetland study has been conducted to establish the sensitive area boundaries on the property. The topographic survey in Appendix A illustrates the location of these areas and the Developed Basin Map in Appendix B illustrates the location of these areas with respect to the proposed development. As previously indicated, it is the intent of this proposal to fill a minor isolated wetland to the south of the existing building.

Soil Type(s):

The existing soil types are:

- 1A Aloha silt loam (NRCS Hydrologic group C/D)

Existing Drainage Features:

The property is currently drained through a series of roof drains, catch basins and piping with the ultimate discharge to the South Tributary of Boeckman Creek. No change of piping network or discharge locations is proposed.

### 3.0 ON-SITE ANALYSIS

#### 3.1 EXISTING ON-SITE FLOW CHARACTERISTICS

The current site does not provide for any on-site retention or water quality facilities. The property is served by an adequate stormwater collection system which will be utilized as-is with the introduction of best management practices (BMP’s) to provide flow control and water quality treatment for the proposed redevelopment.

#### 3.2 IMPERVIOUS AREAS

The proposed redevelopment adds or replaces impervious area in excess of 5,000 SF and therefore triggers City of Wilsonville requirements for stormwater treatment and flow control. In addition, the wetland fill also triggers SLOPES V and Oregon DEQ 401 Water Quality Certification.

**Table 1 – Impervious Areas**

Drainage Management Area	DMA Area in SF (in AC)
N1	40,093 (0.92)
N2	8,208 (0.19)
N3	33,562 (0.77)
N4	72,685 (1.67)
N5	26,396 (0.61)
N6	110,607 (2.54)
N7	74,541 (1.71)
E1	27,970 (0.64)
S1	11,229 (0.26)
S2	10,319 (0.24)
S3	38,183 (0.88)
S4	6,754 (0.16)
S5	66,744 (1.53)
W1	14,404 (0.33)
W2	68,670 (1.58)
W3	6,612 (0.15)
W4	14,836 (0.34)
W5	63,552 (1.46)
<b>Total</b>	<b>695,365 (15.96)</b>

See Appendix B for Pre and Post Development Basin Maps.

### **3.3 METHODOLOGY AND CRITERIA**

Runoff from the proposed condition will maintain existing flow patterns. Site stormwater will be routed through a series of rain gardens which will overflow into the existing storm system. Where a rain garden could not be incorporated into the design due to loading or existing tree constraints, a Contech Stormfilter catch basin has been proposed for water quality treatment.

The design criteria for treatment is the more stringent of the two methods; 1. City of Wilsonville and 2. SLOPES V:

#### Water Quality:

##### **City of Wilsonville:**

1" over 24 hours – Capture and treat 80% of the average annual runoff volume with the goal of 70% total suspended solids (TSS) removal.

##### **SLOPES V:**

50% of 2-yr 24hr event

- 2-yr 24hr for Wilsonville is 2.5" therefore 1.25 inches for SLOPES V

Per paragraph 36. e. of the SLOPES V criteria "A continuous rainfall/runoff model may be used instead of runoff depths to calculate water quality treatment depth. The WES BMP calculator was developed using continuous rainfall modeling and therefore meets the criteria for SLOPES V.

#### Flow Control/Water Quantity:

##### **City of Wilsonville:**

The duration of peak flow rates from post-development conditions shall be less than or equal to the duration of peak flows rates from pre-developed conditions for all peak flows between 42% of the 2-Yr storm up to the 10-yr peak flow rate.

##### **SLOPES V:**

The duration of peak flow rates from post-development conditions shall be less than or equal to the duration of peak flows rates from pre-developed conditions for all peak flows between 50% of the 2-Yr storm up to the 10-yr peak flow rate. (Continuous model)



The City of Wilsonville criteria meets the SLOPES V criteria, so using the WES BMP Calculator meets both design criteria.

Input Parameters/Analysis:

The City of Wilsonville utilizes the Clackamas County Water Environmental Services (WES) Best Management Practices (BMP) Sizing Tool to determine stormwater treatment facilities. As described above, the tool is based upon continuous rainfall data and therefore meets City and SLOPES V criteria.

The input criteria for the BMP Sizing tool are as follows:

Soil Group All DMA's	C/D
Facility Infiltration Rate	C1 (0.35-0.49 in/hr.)
BMP Type	Rain Garden (Treatment & Flow Control)

Infiltration testing was conducted at five locations within the work limits with resulting infiltration rates between 0.25-1.0 in/hr. (see GeoEngineers report in Appendix A). A factor of safety of 2 was applied to determine the design infiltration rate of between 0.12-0.5 in/hr. which corresponds to the BMP calculator category C1 indicated above.

Precipitation Data was obtained from the NOAA Atlas 2 and Hydrograph Method Guidelines from the City of Wilsonville Standards:

NOAA 2-yr -24hr Prec.	2.50 In.
Design Storm 50%	1.25 In. (Used for stormfilters)
SCS Rainfall Depths: (24hr)	
2-yr	2.50 In.
5-yr	3.00 In.
10-yr	3.45 In.
25-yr	3.90 In.
100-yr	4.50 In.

The site discharge values and water quality flows to the catchbasin filters were analyzed using hydrograph and flow data derived using the Santa Barbara Urban Hydrograph (SBUH) method with a NRCS Type 1A 24-hr storm distribution.

The rain garden design parameters from the Wilsonville Standards are as follows:

<u>Standard</u>	<u>Design Value</u>
Width (2' Min Max)	Varies
Side Slopes (3:1 Max)	3:1
Slope (0.5% max)	Varies, 0.5% max
Piping	6" underdrain at min. 1%
Overflow (18" Beehive)	18" w/orifice from underdrain

**Table 2 – BMP Treatment**

Drainage Management Area (DMA)	BMP	Treatment Req'd (SF or # Cartridges)	Treatment Provided (SF or # Cartridges)
N1	Rain Garden	1,604	2,722
N2	Rain Garden	328	640
N3	Catch Basin Filter	7 cartridges	-
N4	Rain Garden	2,907	3,713
N5	Rain Garden	1,056	1,143
N6	Rain Garden	4,424	8,193
N7	Vegetated Swale	2,982	3,008
E1	Filter Strip	1,119	2,000
S1	Catch Basin Filter	3 cartridges	-
S2	Catch Basin Filter	2 cartridges	-
S3	Rain Garden	1,497	5,677
S4	Catch Basin Filter	2 cartridges	-
S5	Rain Garden	2,670	3,829
W1	Rain Garden	576	2,055
W2	Rain Garden	2,447	3,236
W3	Rain Garden	265	1,280
W4	Rain Garden	593	2,523
W5	Rain Garden	2542	3,778

New pipes were sized for a minimum velocity of 3 fps using the SBUH Runoff for a 25-yr event. (See Appendix B for results)

### 3.4 GROWING MEDIUM

The City of Wilsonville Stormwater and Surface Water Standards Appendix A provides standards for stormwater facility Growing Medium which requires a sand/loam/compost 3-way mix to provide for plant establishment. The suggested growing medium mix for the project is “Storm Water Blend 2.3” as manufactured by Pro-Gro Mixes and Materials in Sherwood, Oregon. Specification sheets on the soil blend.

This soil blend provides for filtration through the media to the gravel underdrain/perforated pipe discharge. This provides the desired filtration prior to discharge through the underdrain piping which is connected to the outfall.

This soil blend provides for filtration through the media to the gravel underdrain/perforated pipe discharge. This provides the desired filtration prior to discharge through the underdrain piping which is connected to the outfall.

### **3.5 SITE ULTIMATE OUTFALL**

There is no change in the ultimate stormwater outfall for the updated plan. The existing stormwater piping system is being utilized and the outfall unchanged. The introduction of the BMP treatments on the project will reduce the flow from the site over most storm events, particularly those through the 10-yr storm.

## **4.0 CONSTRUCTION EROSION CONTROL**

The construction erosion control requirements will meet City of Wilsonville guidelines for grading and erosion control.

## **5.0 OPERATION AND MAINTENANCE**

The City of Wilsonville operation and maintenance guidelines are to be implemented with the proposed rain garden installations. Drawing Number ST-6030 of the 2015 Stormwater & Surface Water Design & Construction of the City of Wilsonville provides the Operations and Maintenance Plan for the proposed installation. A draft Operations and Maintenance log based in Appendix D of this report.

## **6.0 SUMMARY AND CONCLUSIONS**

The redevelopment of the Parkway Woods property abides by the City of Wilsonville and SLOPES V stormwater requirements:

- The selected Rain Garden BMP's provide both treatment and flow control to meet the required standards.
- Operation and maintenance will be per the City of Wilsonville standard and a maintenance and access agreement for the rain gardens will be established for the property.

## **7.0 REFERENCES**

1. City of Wilsonville, 2015. *Stormwater & Surface Water Design and Construction Standards, Section 3 – Public Works Standards.*
2. City of Wilsonville/City of Oregon City, 2017. *User's Guide for BMP Sizing Tool.*
3. United States Department of Commerce, National Oceanic Atmospheric Administration, National Marine Fisheries Service, Western Region, March 14, 2014. NWR-2013-10411. *Revised Standard Local Operating Procedures for Endangered Species to Administer Maintenance of Improvement of Stormwater, Transportation, and Utility Actions Authorized or Carried Out by the U.S. Army Corps of Engineers in Oregon (SLOPES for Stormwater, Transportation or Utilities).*

# APPENDIX A

VICINITY MAP

TOPOGRAPHIC SURVEY/EXISTING CONDITIONS

SOIL INFORMATION

INFILTRATION TESTING INFORMATION



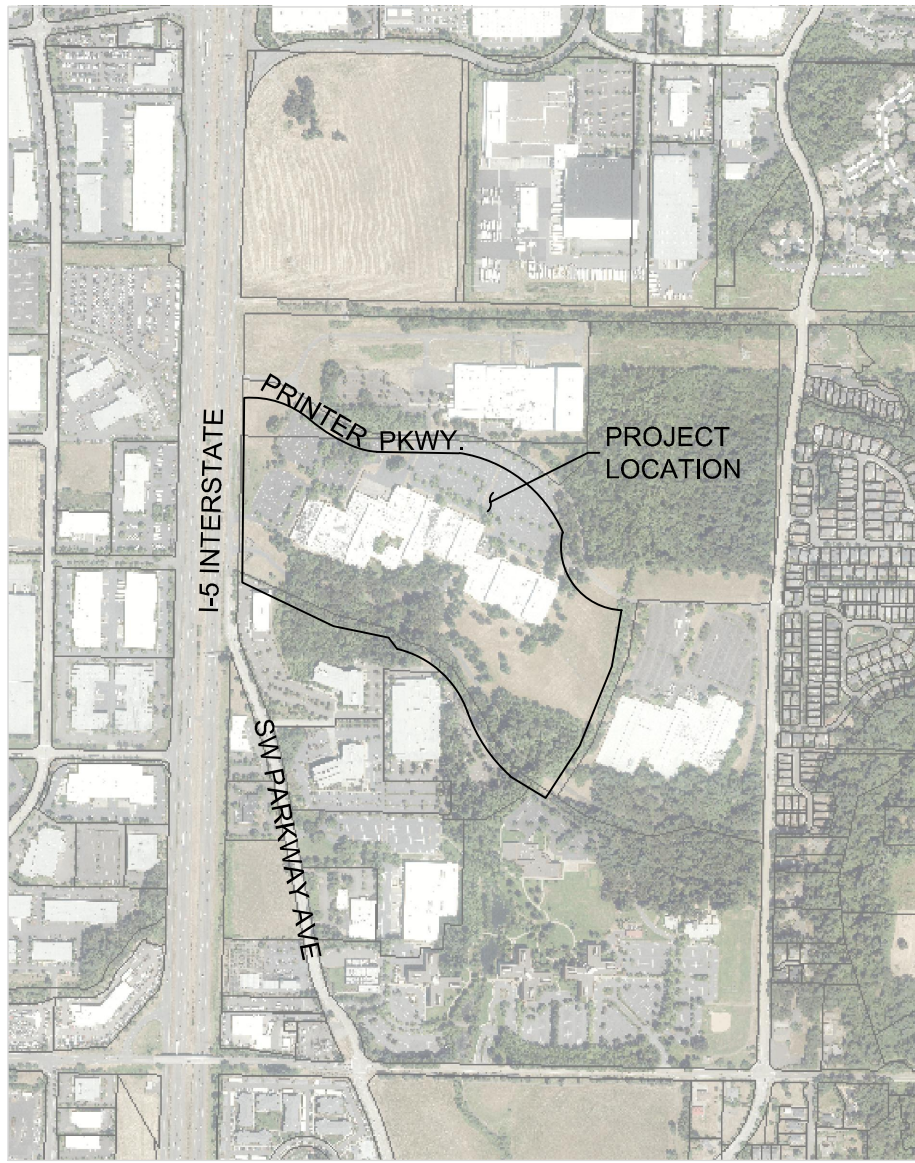

VICINITY MAP  
NOT TO SCALE



PARKWAY WOODS INDUSTRIAL PARK  
WILSONVILLE, OR  
SW MANAGEMENT PLAN

JOB #	19004599
DATE	05/07/20
SCALE	N.T.S.
DRAWN	BLB
SHT 1 OF 1	





- 1 SITE NOTES
- 7 ADA PARKING AREA
- 11 WETLAND
- 12 WETLAND AREA TO BE FILLED
- 13 STORM DRAIN INFRASTRUCTURE
- 14 WATER INFRASTRUCTURE
- 15 TRUCK DOCK LOADING AREA
- 16 BIKE PARKING
- 17 BUILDING ENTRANCE
- 18 WETLAND BUFFER
- 19 SEWER INFRASTRUCTURE
- 20 SIDEWALK
- 21 SOLID WASTE COLLECTION AND RECYCLING
- 22 MOTORCYCLE PARKING
- 23 BUS STOP

THE LOCATIONS OF EXISTING UNDERGROUND UTILITIES ARE SHOWN IN AN APPROXIMATE WAY ONLY AND HAVE NOT BEEN INDEPENDENTLY VERIFIED BY THE CONSULTING ENGINEER. THE CONSULTING ENGINEER SHALL DETERMINE THE EXACT LOCATION OF ALL EXISTING UTILITIES BEFORE COMMENCING WORK, AND AGREES TO BE FULLY RESPONSIBLE FOR ANY AND ALL DAMAGES WHICH MIGHT BE OCCURRED BY THE CONTRACTOR'S FAILURE TO EXACTLY LOCATE AND RESPECTIVE ANY AND ALL UNDERGROUND UTILITIES.

NOTICE: CONSTRUCTION SITE SAFETY IS THE SOLE RESPONSIBILITY OF THE CONTRACTOR. WHETHER THE OWNER OR THE ENGINEER SHALL BE EXPECTED TO ASSUME ANY RESPONSIBILITY FOR SAFETY OF THE WORK OF PERSONS ENGAGED IN THE WORK OF ANY NEARBY STRUCTURES, OR OF ANY OTHER PERSONS.



EXISTING CONDITIONS PLAN  
PRELIMINARY IMPROVEMENT PLANS  
PARKWAY WOODS INDUSTRIAL PARK  
WILSONVILLE, OREGON



REVISIONS:

PM.	B BERRY
DR.	J. GLUECK
JOB NO.	19004599
FILE NO.	19004599-TS02

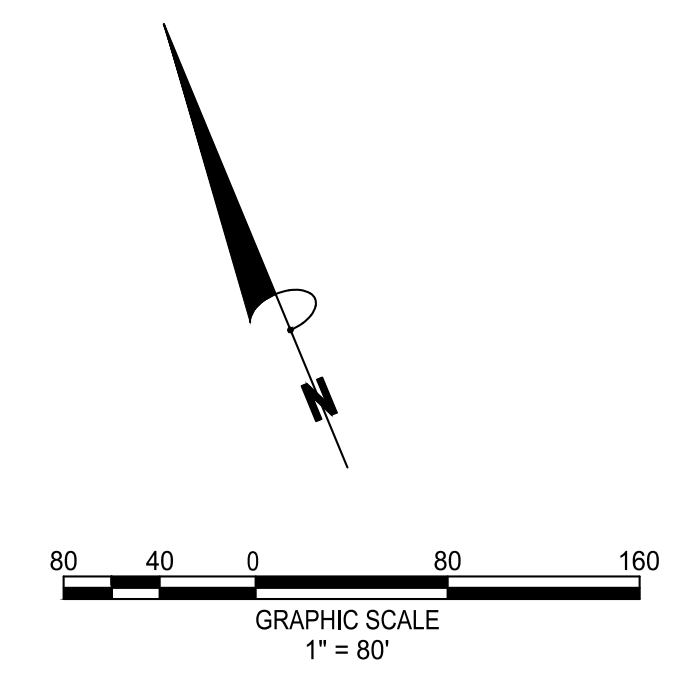
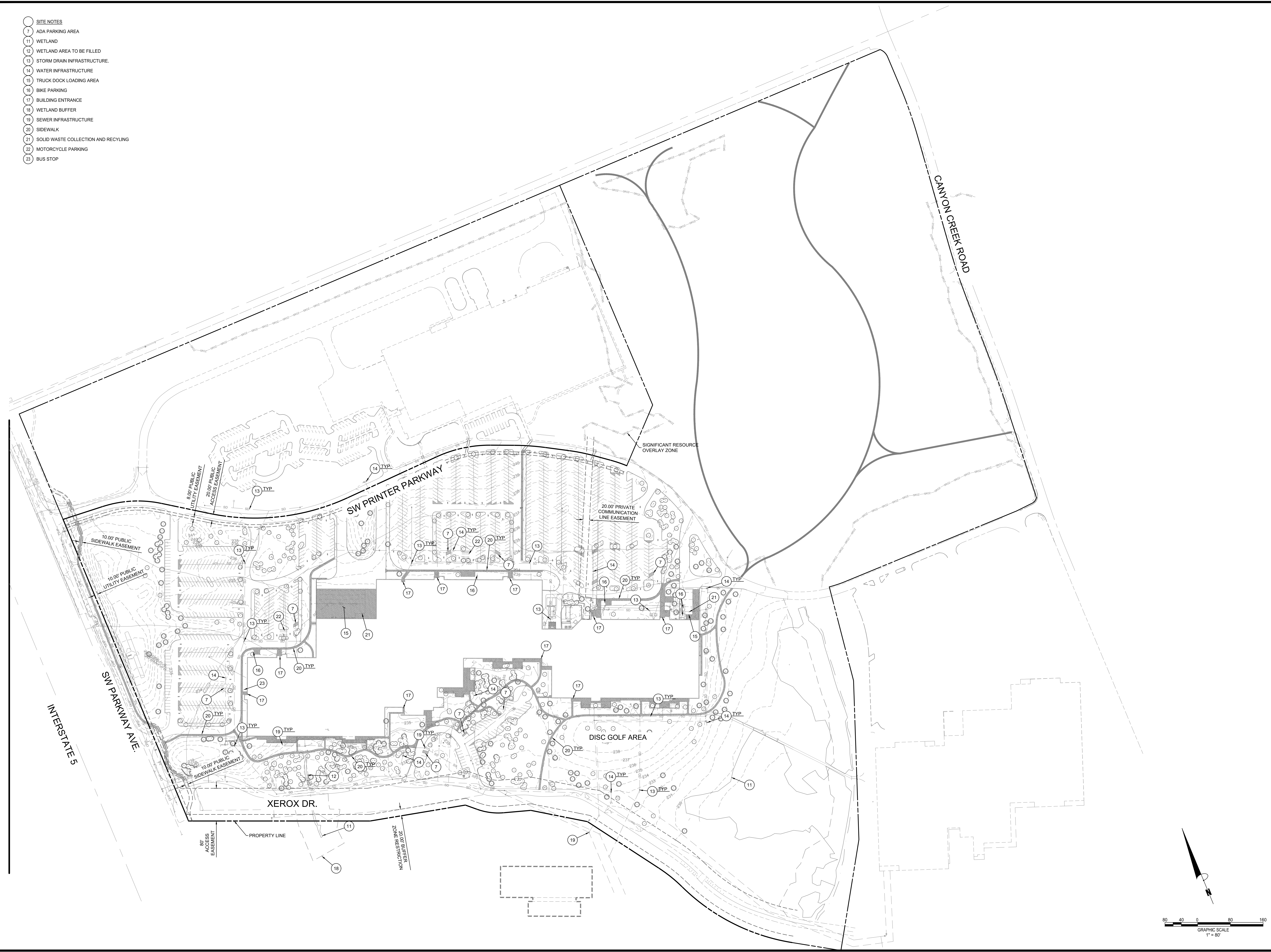

COPYRIGHT © 2020 ATWELL LLC NO REPRODUCTION SHALL BE MADE WITHOUT THE PRIOR WRITTEN CONSENT OF ATWELL LLC



Soil Map—Clackamas County Area, Oregon  
(Parkway Woods)



Map Scale: 1:3,840 if printed on A landscape (11" x 8.5") sheet.

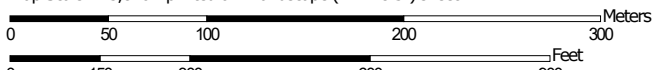

Map projection: Web Mercator Corner coordinates: WGS84 Edge tics: UTM Zone 10N WGS84



## MAP LEGEND

### Area of Interest (AOI)

 Area of Interest (AOI)

### Soils

 Soil Map Unit Polygons

 Soil Map Unit Lines

 Soil Map Unit Points

### Special Point Features



Blowout



Borrow Pit



Clay Spot



Closed Depression



Gravel Pit



Gravelly Spot



Landfill



Lava Flow



Marsh or swamp



Mine or Quarry



Miscellaneous Water



Perennial Water



Rock Outcrop



Saline Spot



Sandy Spot



Severely Eroded Spot



Sinkhole



Slide or Slip



Sodic Spot



Spoil Area



Stony Spot



Very Stony Spot



Wet Spot



Other



Special Line Features

### Water Features



Streams and Canals

### Transportation



Rails



Interstate Highways



US Routes



Major Roads



Local Roads

### Background



Aerial Photography

## MAP INFORMATION

The soil surveys that comprise your AOI were mapped at 1:20,000.

Warning: Soil Map may not be valid at this scale.

Enlargement of maps beyond the scale of mapping can cause misunderstanding of the detail of mapping and accuracy of soil line placement. The maps do not show the small areas of contrasting soils that could have been shown at a more detailed scale.

Please rely on the bar scale on each map sheet for map measurements.

Source of Map: Natural Resources Conservation Service

Web Soil Survey URL:

Coordinate System: Web Mercator (EPSG:3857)

Maps from the Web Soil Survey are based on the Web Mercator projection, which preserves direction and shape but distorts distance and area. A projection that preserves area, such as the Albers equal-area conic projection, should be used if more accurate calculations of distance or area are required.

This product is generated from the USDA-NRCS certified data as of the version date(s) listed below.

Soil Survey Area: Clackamas County Area, Oregon

Survey Area Data: Version 15, Sep 10, 2019

Soil map units are labeled (as space allows) for map scales 1:50,000 or larger.

Date(s) aerial images were photographed: Aug 1, 2019—Sep 12, 2019

The orthophoto or other base map on which the soil lines were compiled and digitized probably differs from the background imagery displayed on these maps. As a result, some minor shifting of map unit boundaries may be evident.

## Map Unit Legend

Map Unit Symbol	Map Unit Name	Acres in AOI	Percent of AOI
1A	Aloha silt loam, 0 to 3 percent slopes	66.4	93.9%
21	Concord silt loam	1.0	1.4%
2225A	Huberly silt loam, 0 to 3 percent slopes	3.4	4.8%
<b>Totals for Area of Interest</b>		<b>70.8</b>	<b>100.0%</b>



- Measured infiltration rates were generally less than 1 inch per hour (0.25 to 1 in/hr) in the Willamette Silts as summarized in Section 5.0 of this report. In general, soils with infiltration rates less than 2 in/hr are not well suited as the sole means of stormwater disposal for sites. In addition, relatively shallow groundwater levels limit the depth to which infiltration facilities can be extended.
- Typical infiltration facilities require at least 5 feet of separation between the base of the facility and the seasonal high groundwater level. That would limit infiltration facility depth to 2 to 4 feet bgs.
- On-site near-surface soils generally consist of medium stiff silt. The silt soils will become significantly disturbed from earthwork occurring during periods of wet weather, or when the moisture content of the soil is more than a few percentage points above optimum. Wet weather construction practices will be required unless earthwork occurs during the dry summer months (typically mid-July to mid-September).
- Proposed structures can be satisfactorily supported on continuous and isolated shallow foundations supported on the firm native soils, or on imported select structural fill that extends to the firm native soils.
- Based on proposed development, our foundation recommendations are based on maximum anticipated loads of 75 kips or less for columns, 4 klf or less for walls, and floor loads of 125 psf or less. Based on these design loads, we estimate total settlement to be less than 1 inch. If larger structural loads are anticipated, we should review and reassess the estimated settlement.
- Fill material encountered at subgrade elevation should be evaluated by GeoEngineers during construction. Soft fill or fill with significant debris or unsuitable material should be removed to native stiff or firmer material and replaced with compacted structural fill.
- Slabs-on-grade will be satisfactorily supported on medium dense native soils with a minimum 6-inch layer of compacted crushed rock base overlying approved subgrade or on structural fill over medium stiff native soils.
- Pavement design considered two options: (1) new pavement or pavement replacement; and (2) an overlay section. We did not consider a grind and inlay section as the relatively thin pavement section would likely be completely demolished by grinding efforts.
- Standard pavement sections prepared as described in this report will suitably support the estimated traffic loads provided the site subgrade is prepared as recommended.

## 5.0 INFILTRATION TESTING

As requested by the project team, we conducted infiltration tests on site to assist in evaluating the potential capacity of on-site soils for design of stormwater infiltration areas at three locations. Tests were performed in general accordance with the encased falling head methods outlined for Professional Method Infiltration testing in the Clackamas County Service District No. 1 (CCSD#1) Stormwater Standards – Appendix E. On-site testing was performed at depths between approximately 3 to 4 feet bgs. Each test location was pre-soaked over a 4-hour period by repeated addition of water into the embedded pipe when necessary.

After the saturation period, the hole was filled with clean water to at least 12 inches above the soil in the bottom of the boring. The drop-in water level was measured over a period of time after the soak period, and refilled to repeat the test a minimum of three times. In the case where the water level falls during the time-

measured testing, infiltration rates diminish as a result of less head from the water column in the test. Field test results are summarized in Table 1.

**TABLE 1. INFILTRATION RESULTS**

Infiltration Test No.	Depth (feet)	USCS Material Type	Soil Description	Field Measured Infiltration Rate <sup>1</sup> (inches/hour)
IT-1-20	4	ML	Yellow-brown silt	0.75
IT-2-20	4	ML	Light gray silt	0.25
IT-3-20	3	ML	Yellow-brown silt	0.25
IT-4-20	4	ML	Yellow-brown silt	1
IT-5-20	3	ML	Yellow-brown silt	0.35

Notes:

<sup>1</sup> Appropriate factors should be applied to the field-measured infiltration rate, based on the design methodology and specific system used.

USCS = Unified Soil Classification System

Infiltration rates shown in Table 1 represent a field-measured infiltration rate. This measurement represents a short-term testing rate, and factors of safety have not been applied for the type of infiltration system being considered, or for variability that may be present across large areas in the on-site soil. In our opinion, and consistent with the state of the practice, correction factors should be applied to this measured rate to reflect the localized area of testing relative to the field sizes.

Appropriate correction factors should also be applied by the project civil engineer to account for long-term infiltration parameters. From a geotechnical perspective, we recommend a factor of safety (correction factor) of at least 2 be applied to the field infiltration values to account for potential soil variability with depth and location within the area tested. In addition, the stormwater system design engineer should determine and apply appropriate remaining correction factor values, or factors of safety, to account for repeated wetting and drying that occur in this area, degree of in-system filtration, frequency and type of system maintenance, vegetation, potential for siltation and bio-fouling, etc., as well as system design correction factors for overflow or redundancy, and base and facility size.

The actual depths, lateral extent and estimated infiltration rates can vary from the values presented above. Field testing/confirmation during construction is often required in large or long systems or other situations where soil conditions may vary within the area where the system is constructed. The results of this field testing might necessitate that the infiltration locations be modified to achieve the design infiltration rate.

The infiltration flow rate of a focused stormwater system, such as a drywell or small infiltration box or pond, typically diminishes over time as suspended solids and precipitates in the stormwater further clog the void spaces between the soil particles or cake on the infiltration surface or in the engineered media. The serviceable life of an infiltration media in a stormwater system can be extended by pre-filtering or with on-going accessible maintenance. Eventually, most systems will fail and will need to be replaced or have media regenerated or replaced.

Because of the very limited infiltration potential of the on-site soils with shallow groundwater conditions, we recommend that infiltration systems include an overflow that is connected to a suitable discharge point.



Also, infiltration systems can cause localized, high groundwater levels and should not be located near basement walls, retaining walls, or other embedded structures unless these are specifically designed to account for the resulting hydrostatic pressure. Infiltration locations should not be located on sloping ground, unless it is approved by a geotechnical engineer, and should not be infiltrated at a location that allows for flow to travel laterally toward a slope face, such as a mounded water condition or too close to a slope face that could cause instability of the slope.

### **5.1. Suitability of Infiltration System**

Successful design and implementation of stormwater infiltration systems and whether a system is suitable for a development depend on several site-specific factors. Stormwater infiltration systems are generally best suited for sites having sandy or gravelly soil with saturated hydraulic conductivities greater than 2 in/hr. That is not the case at this site. Sites with silty/clayey soil such as those encountered at this site, and sites with fine sand, silty sand, or gravel that has a high percentage of silt or clay in the matrix, or sites with relatively shallow underlying decomposed rock (residual soil), are generally not well suited for exclusive stormwater infiltration. Even soils that have fine-grained matrices are susceptible to volumetric change and softening during wetting and drying cycles. Fine-grained soils also have large variations in the magnitude of infiltration rates because of bedding and stratification that occurs during deposition and often has thin layers of less permeable or impermeable soil within a larger layer.

As discussed in Section 3.4 of this report, shallow groundwater was observed at 7 to 9 feet below the existing ground surface. Typical infiltration facilities require a minimum of 5 feet of separation between the facility base and the high groundwater level, which may be as shallow as 5 feet at this site during wet times of the year. Some jurisdictions require up to 10 feet of separation. This would limit the maximum depth of the facility to at least between 3 and 5 feet below the existing ground surface and that is only if 5 feet of separation or less is permitted.

As a result of fine-grained soil conditions, the relatively low measured infiltration rates, and the relatively shallow groundwater levels, we recommend infiltration of stormwater not be used as the sole method of stormwater management at this site unless those design factors can be otherwise accounted for by increasing infiltration area or coupling with other methods of stormwater disposal. Our recommendation is not intended to preclude the use of on-site infiltration, but to provide a framework for the limited capacity for long-term infiltration of any type of facility based on subsurface conditions observed during our exploration and testing.

## **6.0 EARTHWORK RECOMMENDATIONS**

### **6.1. Site Preparation**

#### **6.1.1. General**

In general, site preparation and earthwork for site development will include demolition and removal of existing structures and hardscapes, removal or relocation of existing site utilities where present beneath proposed buildings, excavation for removal of existing foundation elements, hardscape, tree and tree root removal, stripping and grubbing, grading the site and excavating for utilities and foundations. General site grading for building construction in the northwest corner will include removal of an existing 4- to 5-foot-high landscape berm. It is likely that soil placed to build the berm was not structural fill quality and/or not



P:\23\23754001\GIS\MXD\2375400101\_F02\_SP.mxd Date Exported: 04/13/20 by ccabrera

**Notes:**

1. The locations of all features shown are approximate.
2. This drawing is for information purposes. It is intended to assist in showing features discussed in an attached document. GeoEngineers, Inc. cannot guarantee the accuracy and content of electronic files. The master file is stored by GeoEngineers, Inc. and will serve as the official record of this communication.

Data Source: Clarity

Projection: NAD 1983 StatePlane Oregon North FIPS 3601 Feet Intl

**Legend**

- |  |  |
|--|--|
| <ul style="list-style-type: none"> <li> Boring Number and Approximate Location (GeoEngineers 2020)</li> <li> Core Number and Approximate Location (GeoEngineers 2020)</li> <li> Hand Auger Number and Approximate Location (GeoEngineers 2020)</li> <li> Infiltration Number and Approximate Location (GeoEngineers 2020)</li> </ul> | <ul style="list-style-type: none"> <li> Boring Number and Approximate Location (GeoEngineers 2019)</li> <li> Core Number and Approximate Location (GeoEngineers 2019)</li> <li> Infiltration Test Number and Approximate Location (GeoEngineers 2019)</li> </ul> |
|--|--|

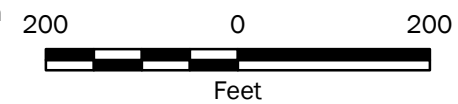
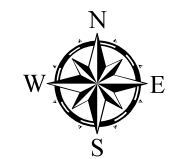

<b>Site Plan</b>	
Parkway Woods Business Park Wilsonville, Oregon	
	<b>Figure 2</b>



Drilled	Start 3/31/2020	End 3/31/2020	Total Depth (ft)	3	Logged By Checked By	JLL	Driller	Dan Fischer Drilling	Drilling Method	Solid-stem Auger
Surface Elevation (ft) Vertical Datum	Undetermined NAVD88				Hammer Data	Rope & Cathead 140 (lbs) / 30 (in) Drop			Drilling Equipment	Buck Rogers Trailer
Easting (X) Northing (Y)					System Datum	OR State Plane North NAD83 (feet)			Groundwater not observed at time of exploration	
Notes:										

Elevation (feet)	FIELD DATA					Graphic Log	Group Classification	MATERIAL DESCRIPTION	Moisture Content (%)	Fines Content (%)	REMARKS
	Depth (feet)	Interval Recovered (in)	Blows/foot	Collected Sample	Sample Name Testing						
0						AC	3-inch-thick asphalt concrete pavement				
						GM	11-inch-thick aggregate base				
						ML	Light gray silt, low to moderate plasticity (medium stiff, moist) (Willamette silt)				
					1						

Note: See Figure A-1 for explanation of symbols.  
Coordinates Data Source: Horizontal approximated based on Google Earth. Vertical approximated based on Google Earth.

Date: 4/17/20 Path: C:\USERS\CESTES\DOCUMENTS\SHAREPOINT DRAFTS\2375400-01\GP1\_DBL\Library\Library\GEOENGINEERS\_DF\_STD\_US\_JUNE\_2017\GLB\GEBR\_GEO TECH\_STANDARD\_MF\_NO\_GW

<b>Log of Boring IT-2-20</b>		
	Project: Parkway Woods Business Park Parking	Figure A-15 Sheet 1 of 1
	Project Location: Wilsonville, Oregon Project Number: 23754-001-01	

## APPENDIX B

PRE-DEVELOPMENT BASIN MAP  
POST DEVELOPMENT BASIN MAP

COPYRIGHT © 2020 ATWELL LLC. NO REPRODUCTION SHALL BE MADE WITHOUT THE PRIOR WRITTEN CONSENT OF ATWELL LLC.

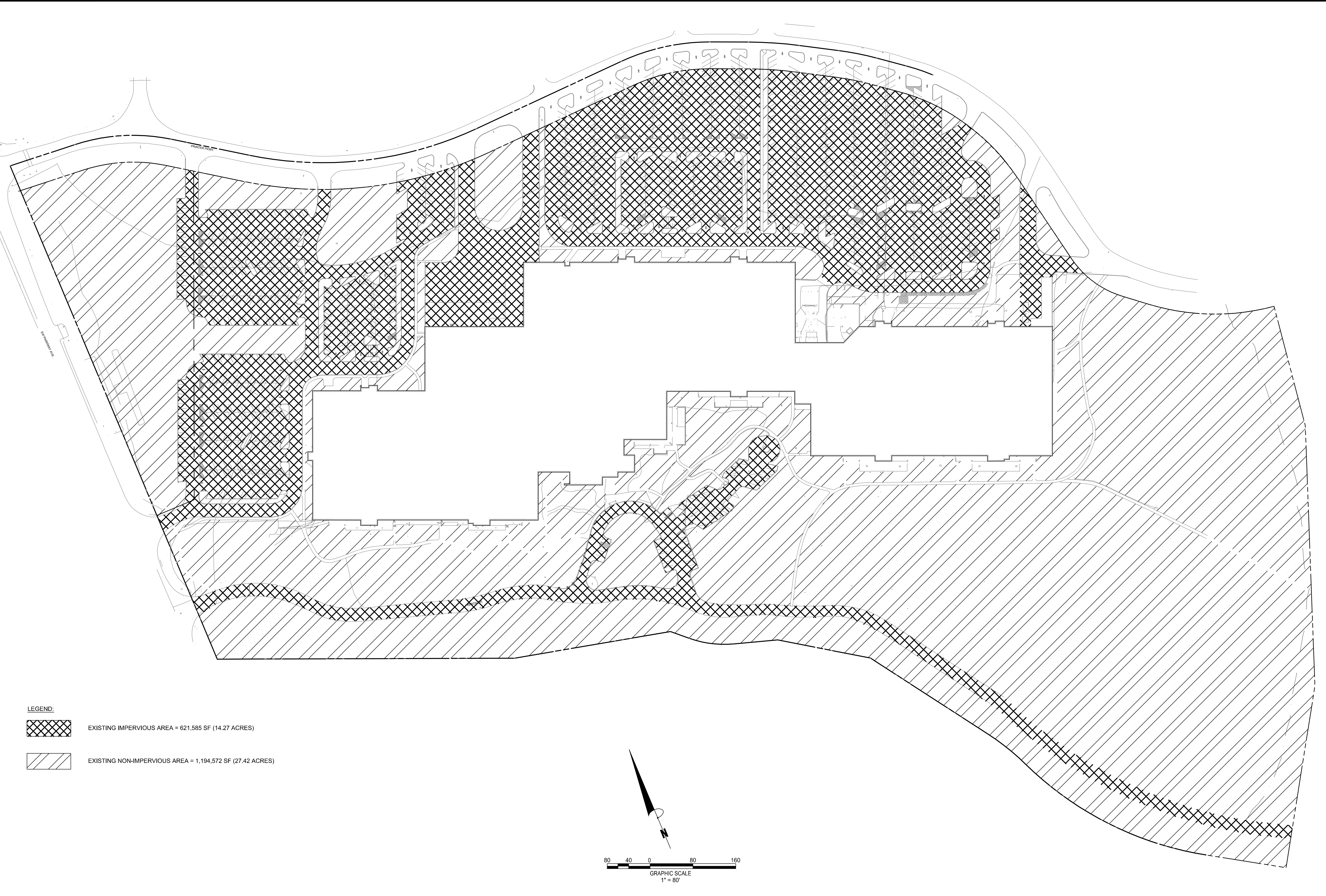

**LEGEND:**

 EXISTING IMPERVIOUS AREA = 621,585 SF (14.27 ACRES)

 EXISTING NON-IMPERVIOUS AREA = 1,194,572 SF (27.42 ACRES)

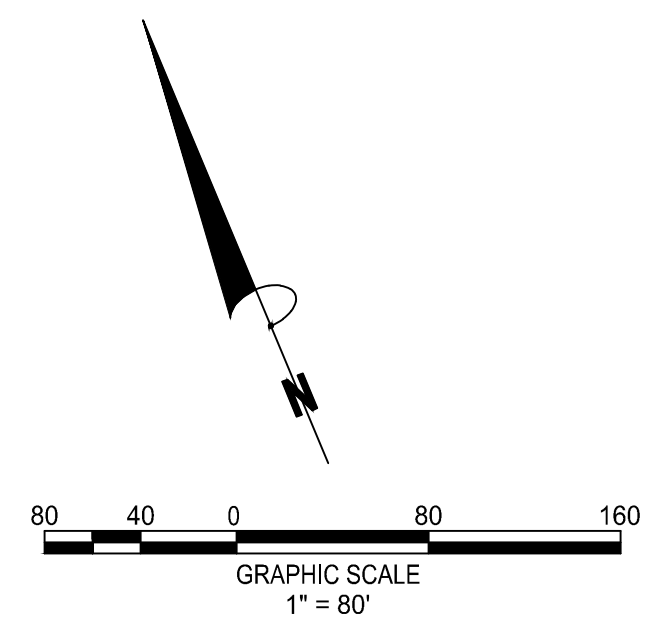

THE LOCATIONS OF EXISTING UNDERGROUND UTILITIES ARE SHOWN IN AN APPROXIMATE WAY ONLY AND HAVE NOT BEEN INDEPENDENTLY VERIFIED BY THE OWNER OR ITS REPRESENTATIVE. THE CONTRACTOR SHALL DETERMINE THE EXACT LOCATION OF ALL EXISTING UTILITIES BEFORE COMMENCING WORK, AND AGREES TO BE FULLY RESPONSIBLE FOR ANY AND ALL DAMAGES WHICH MIGHT BE OCCASIONED BY THE CONTRACTOR'S FAILURE TO EXACTLY LOCATE AND PRESERVE ANY AND ALL UNDERGROUND UTILITIES.

**NOTICE:**  
CONSTRUCTION SITE SAFETY IS THE SOLE RESPONSIBILITY OF THE CONTRACTOR. NEITHER THE OWNER NOR THE ENGINEER SHALL BE EXPECTED TO ASSUME ANY RESPONSIBILITY FOR SAFETY OF THE WORK OF ANY NEARBY STRUCTURES OR OF ANY OTHER PERSONS.



**EXISTING BASIN MAP**  
SW MANAGEMENT PLAN  
**PARKWAY WOODS**  
WILSONVILLE, OR



REVISIONS:



PM.	BLB
DR.	JLG
JOB NO.	14004599
FILE NO.	

SHEET NO.  
**1 OF 2**

P20WS00005, DP19-0313

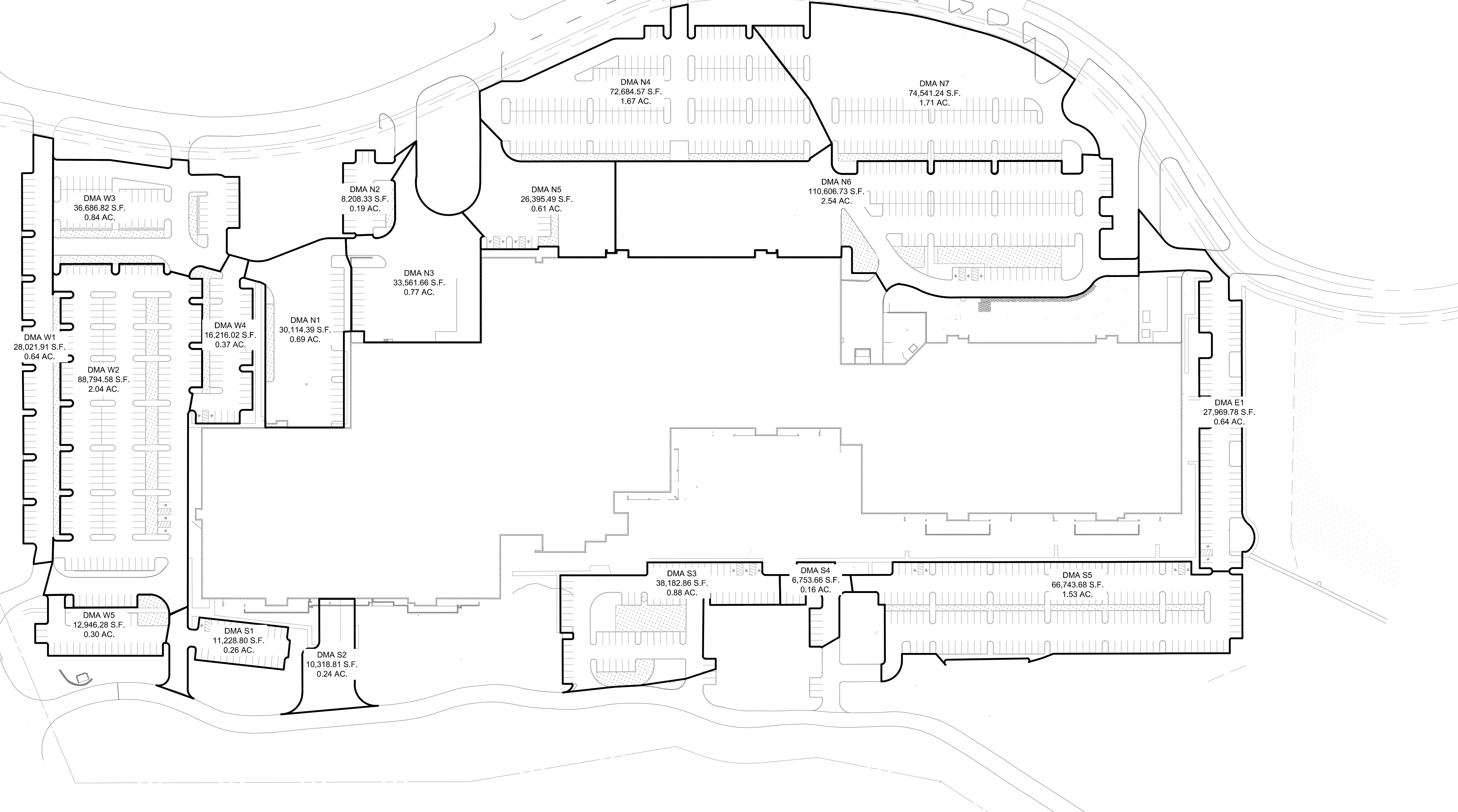

COPYRIGHT © 2020 ATWELL, LLC. NO REPRODUCTION SHALL BE MADE WITHOUT THE PRIOR WRITTEN CONSENT OF ATWELL, LLC.



THE LOCATIONS OF EXISTING UNDERGROUND UTILITIES ARE SHOWN IN AN APPROXIMATE WAY ONLY AND HAVE NOT BEEN INDEPENDENTLY VERIFIED BY THE OWNER OR ITS REPRESENTATIVE. THE CONTRACTOR SHALL DETERMINE THE EXACT LOCATION OF ALL EXISTING UTILITIES BEFORE COMMENCING WORK, AND AGREES TO BE FULLY RESPONSIBLE FOR ANY AND ALL DAMAGES WHICH MIGHT BE OCCASIONED BY THE CONTRACTOR'S FAILURE TO EXACTLY LOCATE AND PRESERVE ANY AND ALL UNDERGROUND UTILITIES.

NOTICE: CONSTRUCTION SITE SAFETY IS THE SOLE RESPONSIBILITY OF THE CONTRACTOR. NEITHER THE OWNER NOR THE ENGINEER SHALL BE EXPECTED TO ASSUME ANY RESPONSIBILITY FOR SAFETY OF THE WORK OF PERSONS ENGAGED IN THE WORK OF ANY NEARBY STRUCTURES OR OF ANY OTHER PERSONS.



**STORMWATER MGMT PLAN**  
PRE-DEVELOPMENT DRAINAGE MAP  
**PARKWAY WOODS**  
WILSONVILLE, OR



REVISIONS:	

PM.	BLB
DR.	JLG
JOB NO.	19004599
FILE NO.	

SHEET NO.  
**1 OF 2**

P20WS00005, DP19-0313



## APPENDIX C

SLOPES – STORMWATER INFORMATION FORM  
WES BMP SIZING REPORT  
STORMFILTER CATCHBASIN CALCULATIONS

# SLOPES for Stormwater, Transportation and Utilities

(NMFS# NWR-2013-10411)

## Stormwater Information Form

If you are submitting a project that includes a stormwater plan for review under SLOPES for Stormwater, Transportation and Utilities please fill out the following cover sheet **to be included with** stormwater management plan, and any other supporting materials.

Also include a drawing of the stormwater treatment area including drainage areas, direction of flow, BMP locations and types, contributing areas, other drainage features, receiving water/location, etc.

Project Information																
	Corps of Engineers permit #															
	Name of Project:															
	Type of project (i.e., residential, commercial, industrial, or combination)															
	Nearest receiving water occupied by ESA-listed species or designated critical habitat															
	Lat/Long (DDD.dddd) of Project Location:															
	Have you contacted anyone at NMFS regarding this project?															
	Applicant/Consultant name:															
	Applicant/Consultant email:															
Stormwater Designer and/or Engineer Contact Information																
	Name:															
	Phone:															
	Email:															
Summary of Design Elements																
1.	<table style="width: 100%; border-collapse: collapse;"> <tr> <td style="width: 30%;">24-hour design storm:</td> <td style="width: 10%; text-align: center;">Inches</td> <td style="width: 40%;">50%* of 2-yr, 24-hr storm fully treated:</td> <td style="width: 10%; text-align: center;">Yes</td> <td style="width: 10%; text-align: center;">No</td> </tr> <tr> <td colspan="5" style="font-size: small;">If no, project may not meet the SLOPES programmatic criteria</td> </tr> <tr> <td colspan="5" style="font-size: x-small;">*May be greater than 50% - see PDC 36.e. for geographically based percentage</td> </tr> </table>	24-hour design storm:	Inches	50%* of 2-yr, 24-hr storm fully treated:	Yes	No	If no, project may not meet the SLOPES programmatic criteria					*May be greater than 50% - see PDC 36.e. for geographically based percentage				
24-hour design storm:	Inches	50%* of 2-yr, 24-hr storm fully treated:	Yes	No												
If no, project may not meet the SLOPES programmatic criteria																
*May be greater than 50% - see PDC 36.e. for geographically based percentage																
2.	2 year, 24 hour storm from NOAA Precipitation Atlas: <span style="float: right;">Inches</span> <a href="http://www.nws.noaa.gov/ohd/hdsc/noaaatlas2.htm">http://www.nws.noaa.gov/ohd/hdsc/noaaatlas2.htm</a>															
3.	<table style="width: 100%; border-collapse: collapse;"> <tr> <td colspan="2"><b>Total</b> contributing impervious area including all contiguous surface (e.g. roads, driveways, parking lots, sidewalks, roofs, and similar surfaces)</td> <td style="text-align: right;">Acres</td> </tr> <tr> <td style="width: 10%;"></td> <td style="padding-left: 20px;">Proposed new</td> <td style="text-align: right;">Acres</td> </tr> <tr> <td></td> <td style="padding-left: 20px;">Existing</td> <td style="text-align: right;">Acres</td> </tr> <tr> <td colspan="2">Acres of total impervious area</td> <td style="text-align: right;">x</td> </tr> <tr> <td colspan="2">design storm =</td> <td style="text-align: right;">ft<sup>3</sup> to be treated</td> </tr> </table>	<b>Total</b> contributing impervious area including all contiguous surface (e.g. roads, driveways, parking lots, sidewalks, roofs, and similar surfaces)		Acres		Proposed new	Acres		Existing	Acres	Acres of total impervious area		x	design storm =		ft <sup>3</sup> to be treated
<b>Total</b> contributing impervious area including all contiguous surface (e.g. roads, driveways, parking lots, sidewalks, roofs, and similar surfaces)		Acres														
	Proposed new	Acres														
	Existing	Acres														
Acres of total impervious area		x														
design storm =		ft <sup>3</sup> to be treated														
4.	Peak discharge of design storm: <span style="float: right;">see explanation</span> cfs															
5.	Total stormwater to be treated: <span style="float: right;">on item #7</span> ft <sup>3</sup> cfs															
6.	Stormwater Design Manual Used and Year/Version: (example: City of Portland, Clean Water Services, King County, Western Washington)  Describe which elements of your stormwater plan came from this manual:															

7.	<p>Have you treated all stormwater to the design storm within the contributing impervious area?          Yes No          If no, why not and how will you offset the effects from remaining stormwater?</p>	
Water Quality		
8.	<p>Low Impact Development methods incorporated? Yes No          (e.g. site layout, vegetation and soil protection, reforestation, integrated management practices such as amended soils, bioretention, permeable pavement, rainwater collection, tree retention)          Please describe:</p> <p>How much of total stormwater is treated using LID:</p>	
9.	<p>Treatment train, including pretreatment and bioretention methods used to treat water quality:</p> <p>Why this treatment train was chosen for the project site:</p> <p>Page in stormwater plan where more details can be found:</p>	
Water Quantity		
10.	<p>Does the project discharge directly into a major water body (see PDC 36.c.iii)? Yes No</p>	
11.	<p>Pre-development runoff rate          (i.e., before human-induced changes to the unimproved property)          2-yr, 24-hour storm: <a href="#">see explanation on item #7</a>          10-yr storm: <a href="#">see explanation on item #7</a></p>	<p>Post-development runoff rate          (i.e., after proposed developments)          2-yr, 24-hour storm: <a href="#">see explanation on item #7</a>          10-yr storm: <a href="#">see explanation on item #7</a></p>
<b>Post-development runoff rate must be less than or equal to pre-development runoff rate</b>		
12.	<p>Methods used to treat water quantity:</p> <p>Page in stormwater plan where more details can be found:</p>	

Maintenance and Inspection Plan

13.

Have you included a stormwater maintenance plan with a description of the onsite stormwater system, inspection schedule and process, maintenance activities, legal and financial responsibility, and inspection and maintenance logs?      Yes      No\*

\*Projects cannot be submitted for review under SLOPES without a maintenance and inspection plan.

Page in stormwater plan where plan can be found:

14.

Contact information for the party/parties that will be legally responsible for performing the inspections and maintenance or the stormwater facilities:

Name: \_\_\_\_\_

Phone number: \_\_\_\_\_

Email: \_\_\_\_\_

Name: \_\_\_\_\_

Phone number: \_\_\_\_\_

Email: \_\_\_\_\_

Name: \_\_\_\_\_

Phone number: \_\_\_\_\_

Email: \_\_\_\_\_

Page in stormwater plan where more details can be found:



## WES BMP Sizing Report

## Project Information

Project Name	MParkway Woods
Project Type	Addition
Location	
Stormwater Management Area	700000
Project Applicant	Atwell, LLC
Jurisdiction	CCSD1NCSA

## Drainage Management Area

Name	Area (sq-ft)	Pre-Project Cover	Post-Project Cover	DMA Soil Type	BMP
DMA W1	14,404	Forested	ConventionalConcrete	D	BMP - W1
DMA - W2	68,670	Forested	ConventionalConcrete	D	BMP - W2
DMA - W3	6,612	Forested	ConventionalConcrete	D	BMP - W3
DMA - W4	14,836	Forested	ConventionalConcrete	D	BMP - W4
DMA - W5	63,552	Forested	ConventionalConcrete	D	BMP - W5
DMA - N1	40,093	Forested	ConventionalConcrete	D	BMP - N1
DMA - N2	8,208	Forested	ConventionalConcrete	D	BMP - N2
DMA - N4	72,685	Forested	ConventionalConcrete	D	BMP - N4
DMA - N5	26,396	Forested	ConventionalConcrete	D	BMP - N5
DMA - N7	74,541	Forested	ConventionalConcrete	D	BMP - N7
DMA - N6	110,607	Forested	ConventionalConcrete	D	BMP - N6
DMA - E1	27,970	Grass	ConventionalConcrete	D	BMP - E1
DMA - S3	38,183	Forested	ConventionalConcrete	D	BMP - S3
DMA - S5	66,744	Grass	ConventionalConcrete	D	BMP - S5

## LID Facility Sizing Details

LID ID	Design Criteria	BMP Type	Facility Soil Type	Minimum Area (sq-ft)	Planned Areas (sq-ft)	Orifice Diameter (in)
BMP - W3	FlowControlAndTreatment	Rain Garden - Filtration	C1	264.5	1,280.0	0.8
BMP - W1	FlowControlAndTreatment	Rain Garden - Filtration	C1	576.2	2,055.0	1.2
BMP - W2	FlowControlAndTreatment	Rain Garden - Filtration	C1	2,746.8	3,236.0	2.6
BMP - W4	FlowControlAndTreatment	Rain Garden - Filtration	C1	593.4	2,523.0	1.2
BMP - W5	FlowControlAndTreatment	Rain Garden - Filtration	C1	2,542.1	3,778.0	2.5
BMP - S3	FlowControlAndTreatment	Rain Garden - Filtration	C1	1,527.3	5,648.3	2.0
BMP - S5	FlowControlAndTreatment	Rain Garden - Filtration	C1	2,669.8	3,829.3	2.6
BMP - N6	FlowControlAndTreatment	Rain Garden - Filtration	C1	4,424.3	8,193.4	3.3
BMP - N5	FlowControlAndTreatment	Rain Garden - Filtration	C1	1,055.8	1,142.5	1.6
BMP - N4	FlowControlAndTreatment	Rain Garden - Filtration	C1	2,907.4	3,713.5	2.7
BMP - N2	FlowControlAndTreatment	Rain Garden - Filtration	C1	328.3	640.0	0.9
BMP - N1	FlowControlAndTreatment	Rain Garden - Filtration	C1	1,603.7	2,722.0	2.0
BMP - E1	FlowControlAndTreatment	Vegetated Swale - Filtration	C1	1,118.8	2,000.0	1.9
BMP - N7	FlowControlAndTreatment	Vegetated Swale - Filtration	C1	2,981.6	3,007.8	3.0

## Pond Sizing Details

1. FCWQT = Flow control and water quality treatment, WQT = Water quality treatment only
2. Depth is measured from the bottom of the facility and includes the three feet of media (drain rock, separation layer and growing media).
3. Maximum volume of the facility. Includes the volume occupied by the media at the bottom of the facility.
4. Maximum water storage volume of the facility. Includes water storage in the three feet of soil media assuming a 40 percent porosity.

<b>Stomrfilter Catch Basin Calculations</b>		
<b>Project Name:</b>	19004599 Parkway Woods Industrial Park	Date: 4/28/2020
<b>Computed By:</b>	JLG	
<b>Company:</b>	Atwell Group, Inc.	
<b>Address:</b>	26600 SW Parkway Avenue, Wilsonville, OR	

**\*See Appendix C for Basin Areas**

CONTRIBUTING BASINS:

BASIN	IMPERVIOUS AREA (SF)	IMPERVIOUS AREA (ACRES)	TREATMENT FACILITY
N3	33,562	0.77	WQ CB #1
S1	11,229	0.26	WQ CB #2
S2	10,319	0.24	WQ CB #3
S4	6,754	0.16	WQ CB #4

**WATER QUALITY CALCULATIONS**

**Water Quality flow (Q)**

N3 - Q1 =	<b>0.21 cfs</b>
S1 - Q2 =	<b>0.07 cfs</b>
S2 - Q3 =	<b>0.06 cfs</b>
S4 - Q4 =	<b>0.04 cfs</b>

**StormFilter Cartridges required:**

Water quality flow x (449gpm/cfs) / (15gpm/cartridge)

	Impervious area (SF)	Impervious area (Acres)	WQ Flow Rate (CFS)	Cartridges Required with 2.3' drop
N3 - WQ CB #1	33,562	0.77	N3 - Q1 = 0.21	7.00 cartridges
S1 - WQ CB #2	11,229	0.26	S1 - Q2 = 0.07	3.00 cartridges
S2 - WQ CB #3	10,319	0.24	S2 - Q3 = 0.06	2.00 cartridges
S4 - WQ CB #4	6,754	0.16	S4 - Q4 = 0.04	2.00 cartridges





## APPENDIX D

BMP INFORMATION

WILSONVILLE STANDARD DETAILS

GROWING MEDIUM CUT SHEETS

GROWING MEDIUM SPECIFICATIONS

OPERATION AND MAINTENANCE SCHEDULE

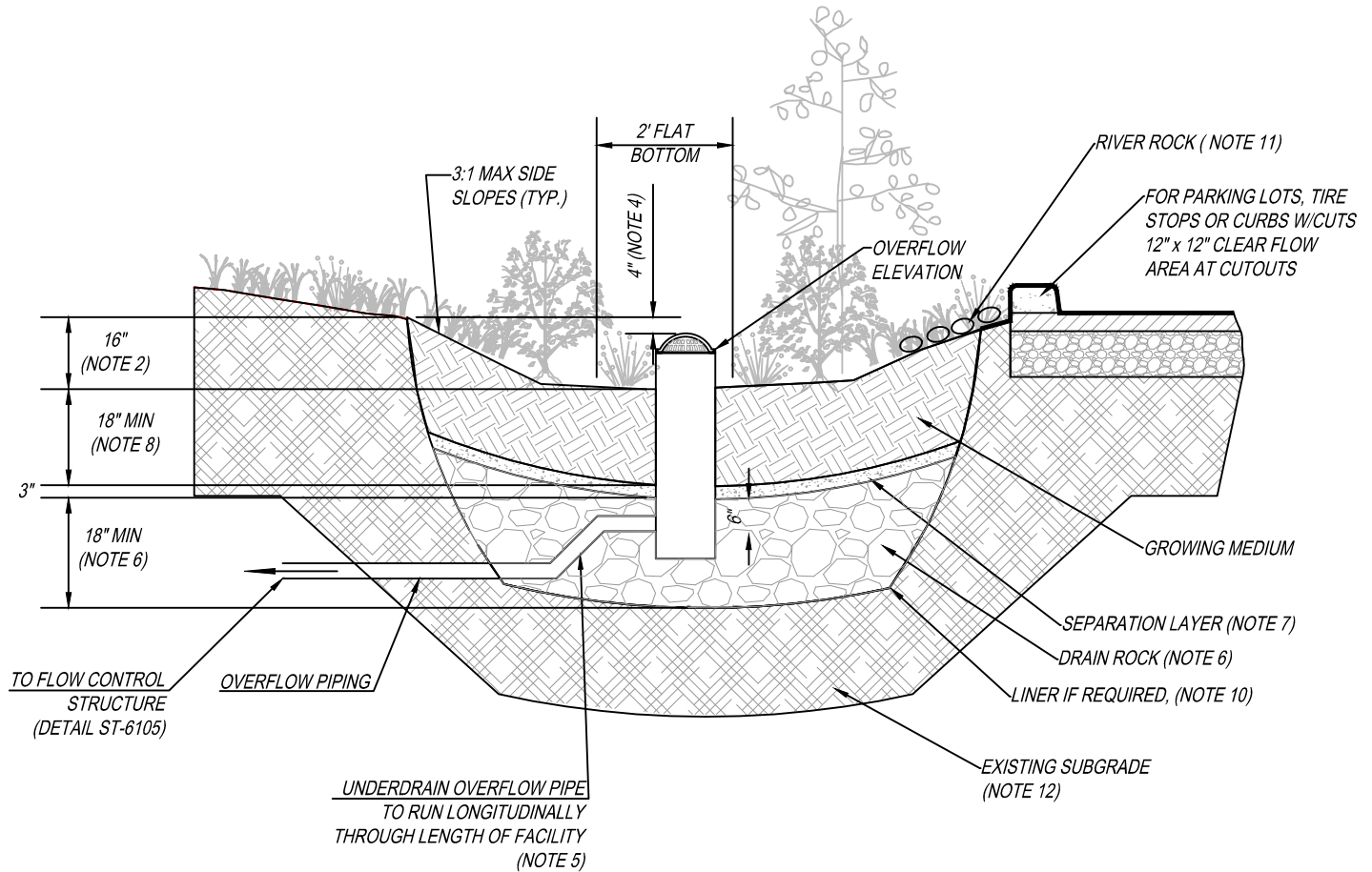

GENERAL NOTES:

1. **PROVIDE PROTECTION** FROM ALL VEHICLE TRAFFIC, EQUIPMENT STAGING, AND FOOT TRAFFIC IN PROPOSED INFILTRATION AREAS PRIOR TO, DURING AND AFTER CONSTRUCTION. UNLESS REQUIRED BY SITE CONDITIONS, UNLINED RAIN GARDENS ARE PREFERRED TO MAXIMIZE ONSITE INFILTRATION.
2. **DIMENSIONS:**
  - DEPTH OF BASIN (FROM TOP OF GROWING MEDIUM TO OVERFLOW ELEVATION); 12"
  - FLAT BOTTOM WIDTH: 2' MINIMUM
  - SIDE SLOPES OF RAIN GARDEN: 3:1 MAXIMUM
  - CENTERLINE SLOPE OF RAIN GARDEN: 0.5% OR LESS
3. **SETBACKS:**
  - FILTRATION RAIN GARDEN SHALL BE 10' FROM FOUNDATIONS AND 5' FROM PROPERTY LINES UNLESS APPROVED BY BUILDING OFFICIAL
4. **OVERFLOW:**
  - OVERFLOW REQUIRED. INLET ELEVATION SHALL ALLOW FOR 4" OF FREEBOARD, MINIMUM.
  - PROTECT FROM DEBRIS AND SEDIMENT WITH STRAINER OR GRATE.
5. **PIPING:**
  - PERFORATED UNDER-DRAIN PIPING: SHALL RUN LONGITUDINALLY THROUGH LENGTH OF FACILITY, SHALL BE ABS SCH. 40, CAST IRON, OR PVC SCH.40. MINIMUM DIAMETER IS 6". PIPING SHALL HAVE 1% GRADE AND FOLLOW THE UNIFORM PLUMBING CODE. PVC NOT ALLOWED ABOVE GROUND. WRAP UNDER-DRAIN IN FILTER FABRIC TO REDUCE TRANSPORT OF FINES. OVERFLOW PIPING: SHALL BE ABS SCH. 40, CAST IRON, OR PVC SCH. 40 AND SHALL NOT BE PERFORATED. MINIMUM DIAMETER IS 6". PIPING SHALL HAVE 1% GRADE AND FOLLOW THE UNIFORM PLUMBING CODE. PVC NOT ALLOWED ABOVE GROUND.
6. **DRAIN ROCK:**
  - SIZE: 1 1/2" to 3/4"-0 WASHED
  - DEPTH: 18" MINIMUM
7. **SEPARATION** BETWEEN DRAIN ROCK AND GROWING MEDIUM: SHALL BE A 3" LAYER OF 3/4" - 1/4" OPEN GRADED AGGREGATE.
8. **GROWING MEDIUM:**
  - DEPTH: 18" MINIMUM
  - SEE APPENDIX A FOR SPECIFICATION OR USE SAND/LOAM/COMPOST 3-WAY MIX.
  - FACILITY SURFACE AREA MAY BE REDUCED BY 25% WHEN GROWING MEDIA DEPTH IS INCREASED TO 30" OR MORE.
9. **VEGETATION:** FOLLOW LANDSCAPE PLANS OR REFER TO PLANTING REQUIREMENTS IN APPENDIX A.
10. **WATERPROOF LINER (IF REQUIRED):** SHALL BE 30 MIL PVC OR EQUIVALENT.
11. **INSTALL RIVER ROCK** SPLASH PAD OVER A NON WOVEN GEO TEXTILE FABRIC TO TRANSITION FROM INLETS TO GROWING MEDIUM. SIZE OF ROCK SHALL BE 1" - 3", 4 SQUARE FEET, 6" DEEP.
12. **SEASONAL HIGH GROUNDWATER SEPARATION:**
  - SEPARATION DISTANCE AS REQUIRED BY CITY.

Rain Garden - Filtration

CITY OF  
WILSONVILLE



DRAWING NUMBER: ST-6020

DRAWN BY: SR

SCALE: N.T.S.

FILE NAME: ST-6020.DWG

APPROVED BY: NK

DATE: 4/16/18

PUBLIC WORKS STANDARDS

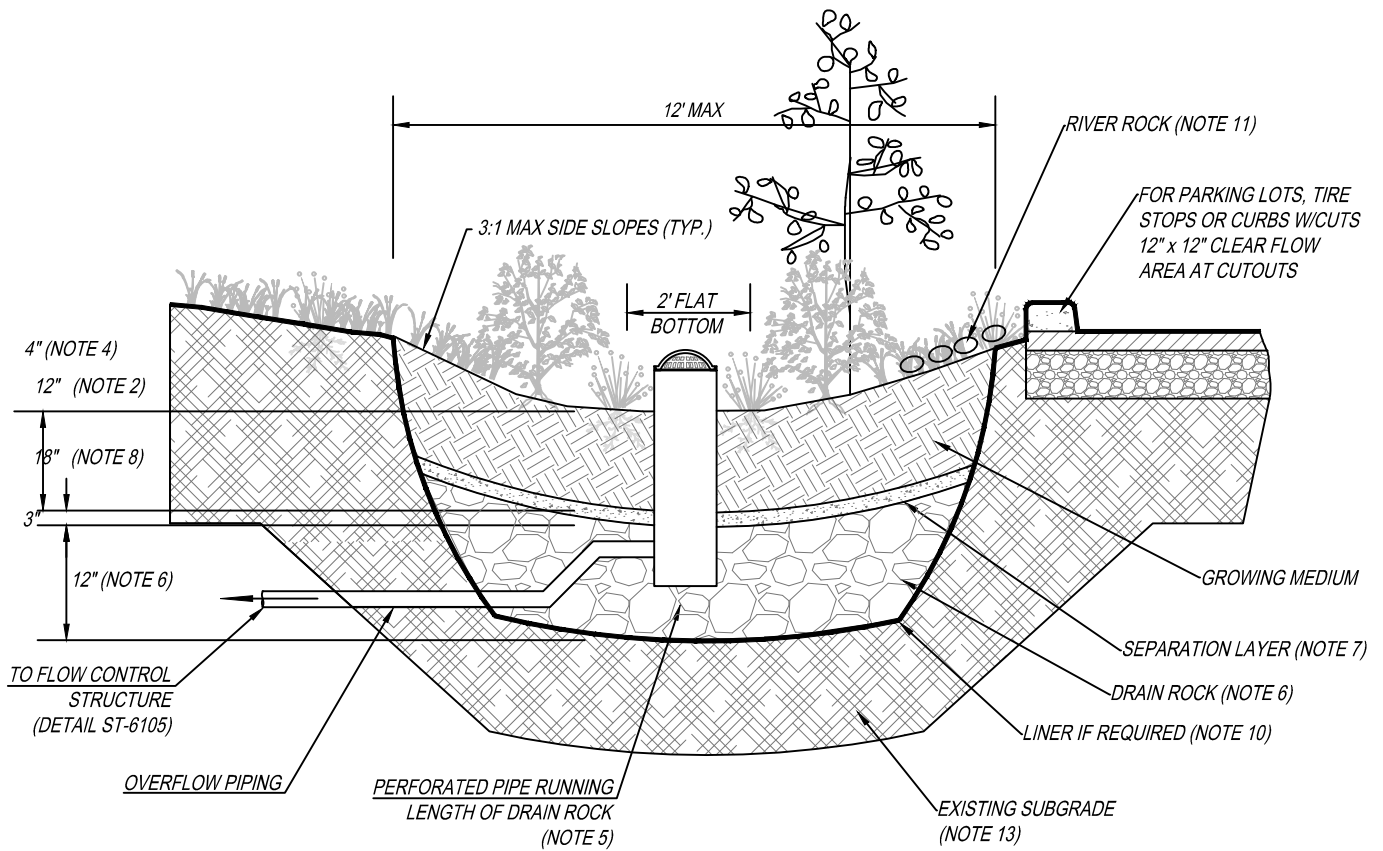

**GENERAL NOTES:**

1. **PROVIDE PROTECTION** FROM ALL VEHICLE TRAFFIC, EQUIPMENT STAGING, AND FOOT TRAFFIC IN PROPOSED INFILTRATION AREAS PRIOR TO, DURING AND AFTER CONSTRUCTION. UNLESS REQUIRED BY SITE CONDITIONS, UNLINED SWALES ARE PREFERRED TO ALLOW MAXIMUM INFILTRATION.
2. **DIMENSIONS:**
  - DEPTH OF SWALE (FROM TOP OF GROWING MEDIUM TO OVERFLOW ELEVATION); 12"
  - LONGITUDINAL SLOPE OF SWALE: 6.0% OR LESS
  - FLAT BOTTOM WIDTH: 2' MINIMUM
  - SIDE SLOPES OF SWALE: 3:1 MAXIMUM
3. **LOCATION/SETBACKS:**
  - FILTRATION SWALES SHALL BE 10' FROM FOUNDATIONS AND 5' FROM PROPERTY LINES UNLESS APPROVED BY BUILDING OFFICIAL
4. **OVERFLOW:**
  - INLET ELEVATION SHALL ALLOW FOR 4" OF FREEBOARD, MINIMUM.
  - PROTECT FROM DEBRIS AND SEDIMENT WITH STRAINER OR GRATE.
5. **PIPING:**
  - PERFORATED UNDER-DRAIN PIPING: SHALL BE ABS SCH. 40, CAST IRON, OR PVC SCH.40. MINIMUM DIAMETER IS 6". PIPING SHALL HAVE 1% GRADE AND FOLLOW THE UNIFORM PLUMBING CODE. PVC NOT ALLOWED ABOVE GROUND. WRAP UNDER-DRAIN IN FILTER FABRIC TO REDUCE TRANSPORT OF FINES.
  - OVERFLOW PIPING: SHALL BE ABS SCH. 40, CAST IRON, OR PVC SCH. 40 AND SHALL NOT BE PERFORATED. MINIMUM DIAMETER IS 6". PIPING SHALL HAVE 1% GRADE AND FOLLOW THE UNIFORM PLUMBING CODE. PVC NOT ALLOWED ABOVE GROUND.
6. **DRAIN ROCK:**
  - SIZE: 1 1/2" - 3/4" WASHED
  - DEPTH: 12"
7. **SEPARATION** BETWEEN DRAIN ROCK AND GROWING MEDIUM: SHALL BE A 3" LAYER OF 3/4" - 1/4" OPEN GRADED AGGREGATE.
8. **GROWING MEDIUM:**
  - 18" MINIMUM
  - SEE APPENDIX C FOR SPECIFICATION OR USE SAND/LOAM/COMPOST 3-WAY MIX.
  - FACILITY SURFACE AREA MAY BE REDUCED BY 25% WHEN GROWING MEDIA DEPTH IS INCREASED TO 30" OR MORE.
9. **VEGETATION:** FOLLOW LANDSCAPE PLANS OR REFER TO PLANTING REQUIREMENTS IN APPENDIX A.
10. **WATERPROOF LINER (IF REQUIRED):** SHALL BE 30 MIL PVC OR EQUIVALENT.
11. **INSTALL RIVER ROCK** SPLASH PAD OVER A NON WOVEN GEO TEXTILE FABRIC TO TRANSITION FROM INLETS TO GROWING MEDIUM. SIZE OF ROCK SHALL BE 1" TO 3", 4 SQUARE FEET, 6" DEEP.
12. **CHECK DAMS:** SHALL BE PLACED ACCORDING TO FACILITY DESIGN. REFER TO DETAIL ST-6100 FOR PROFILE AND SPACING.
13. **SEASONAL HIGH GROUNDWATER SEPARATION:**
  - SEPARATION DISTANCE AS REQUIRED BY CITY.

**Vegetated Swale - Filtration**

DRAWING NUMBER: ST-6045

DRAWN BY: SR

SCALE: N.T.S.

FILE NAME: ST-6045.DWG

APPROVED BY: NK

DATE: 4/16/18

**CITY OF  
WILSONVILLE**



**PUBLIC WORKS STANDARDS**

This Detail Drawing may not be altered or changed in any manner except by the City Engineer. It is the responsibility of the user to acquire the most current version.

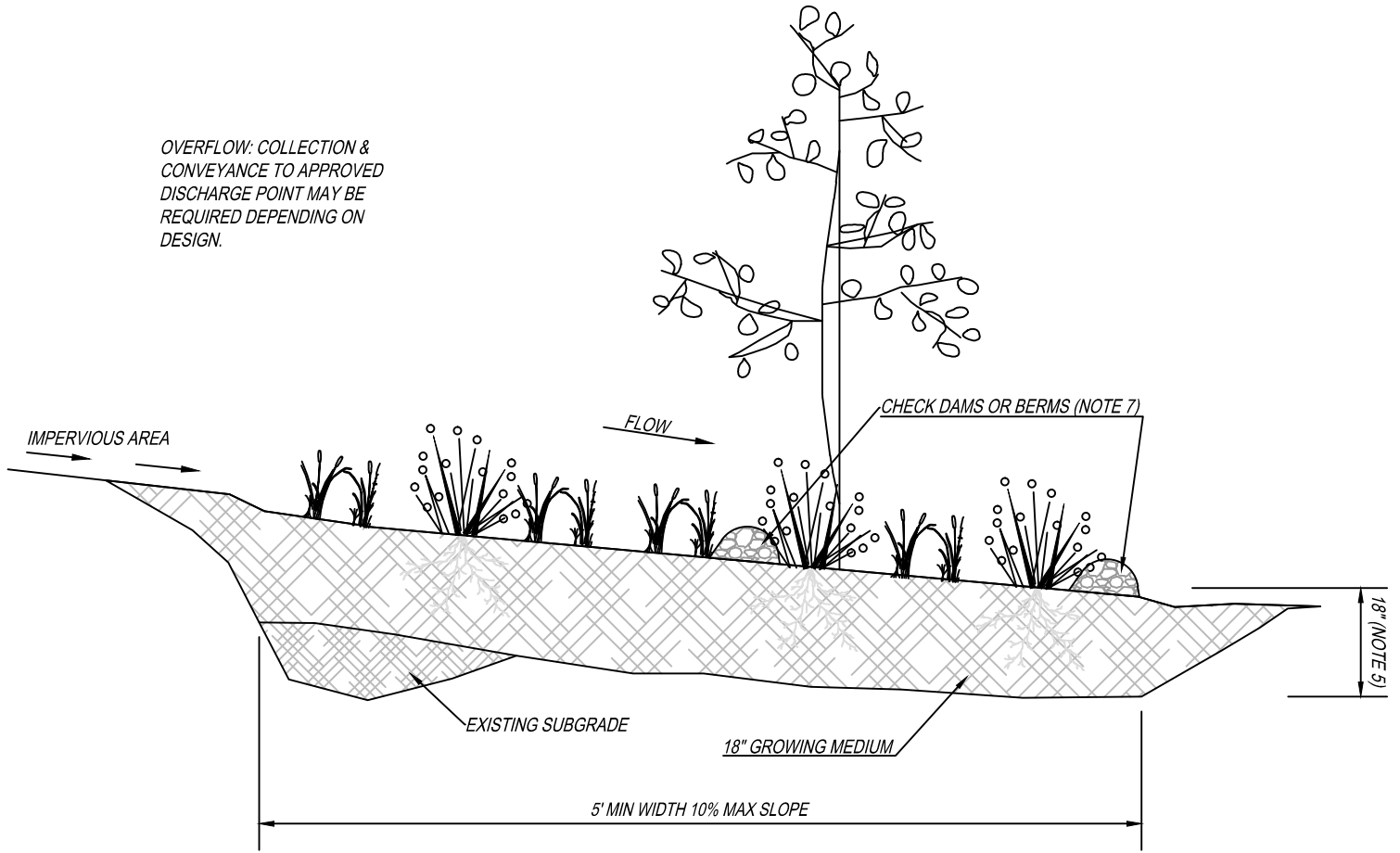

OVERFLOW: COLLECTION & CONVEYANCE TO APPROVED DISCHARGE POINT MAY BE REQUIRED DEPENDING ON DESIGN.

CHECK DAMS OR BERMS (NOTE 7)

18" (NOTE 5)

EXISTING SUBGRADE

18" GROWING MEDIUM

5' MIN WIDTH 10% MAX SLOPE

GENERAL NOTES:

1. **PROVIDE PROTECTION** FROM ALL VEHICLE TRAFFIC, EQUIPMENT STAGING, AND FOOT TRAFFIC IN PROPOSED INFILTRATION AREAS PRIOR TO, DURING AND AFTER CONSTRUCTION.
2. **DIMENSIONS:**  
-FLOW LINE WIDTH: BASED ON LENGTH OF IMPERVIOUS FLOW PATH AND SLOPE OF FILTER STRIP. SEE TABLE. 5' MINIMUM  
-SLOPES: 0.5 - 15%
3. **SETBACKS (FROM EDGE OF FACILITY):**  
-5' FROM PROPERTY LINE  
-10' FROM FOUNDATIONS
4. **OVERFLOW:**  
-COLLECTION FROM FILTER STRIP SHALL BE SPECIFIED ON PLANS
5. **GROWING MEDIUM:** FILTER STRIP, GROWING MEDIUM SHALL BE USED WITHIN THE TOP 18" (SEE APPENDIX A FOR SPECIFICATIONS OR USE SAND/LOAM/COMPOST 3-WAY MIX)
6. **VEGETATION:** THE ENTIRE FILTER STRIP MUST HAVE 100% COVERAGE BY NATIVE GRASSES, NATIVE WILDFLOWER BLENDS, NATIVE GROUND COVERS, OR ANY COMBINATION THEROF
7. **CHECK DAMS** SHALL BE PLACED ACCORDING TO FACILITY DESIGN. REFER TO DETAIL ST-6100 FOR PROFILE AND SPACING.

LENGTH OF IMPERVIOUS AREA FLOW PATH (30' MAX)

SLOPE OF FILTER STRIP	LENGTH OF IMPERVIOUS AREA FLOW PATH (30' MAX)			
	5'	10'	20'	30'
2%	5'	5'	5'	5'
5%	5'	5'	7'	9'
10%	5'	7'	10'	14'
15%	5'	9'	13'	16'

Vegetated Filter Strip

DRAWING NUMBER: ST-6035

DRAWN BY: SR

SCALE: N.T.S.

FILE NAME: ST-6035.DWG

APPROVED BY: NK

DATE: 10/21/14

CITY OF WILSONVILLE



PUBLIC WORKS STANDARDS



This Detail Drawing may not be altered or changed in any manner except by the City Engineer. It is the responsibility of the user to acquire the most current version.

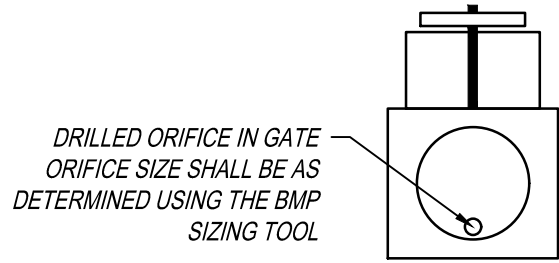

**END VIEW  
(PVC GATE VALVE)**

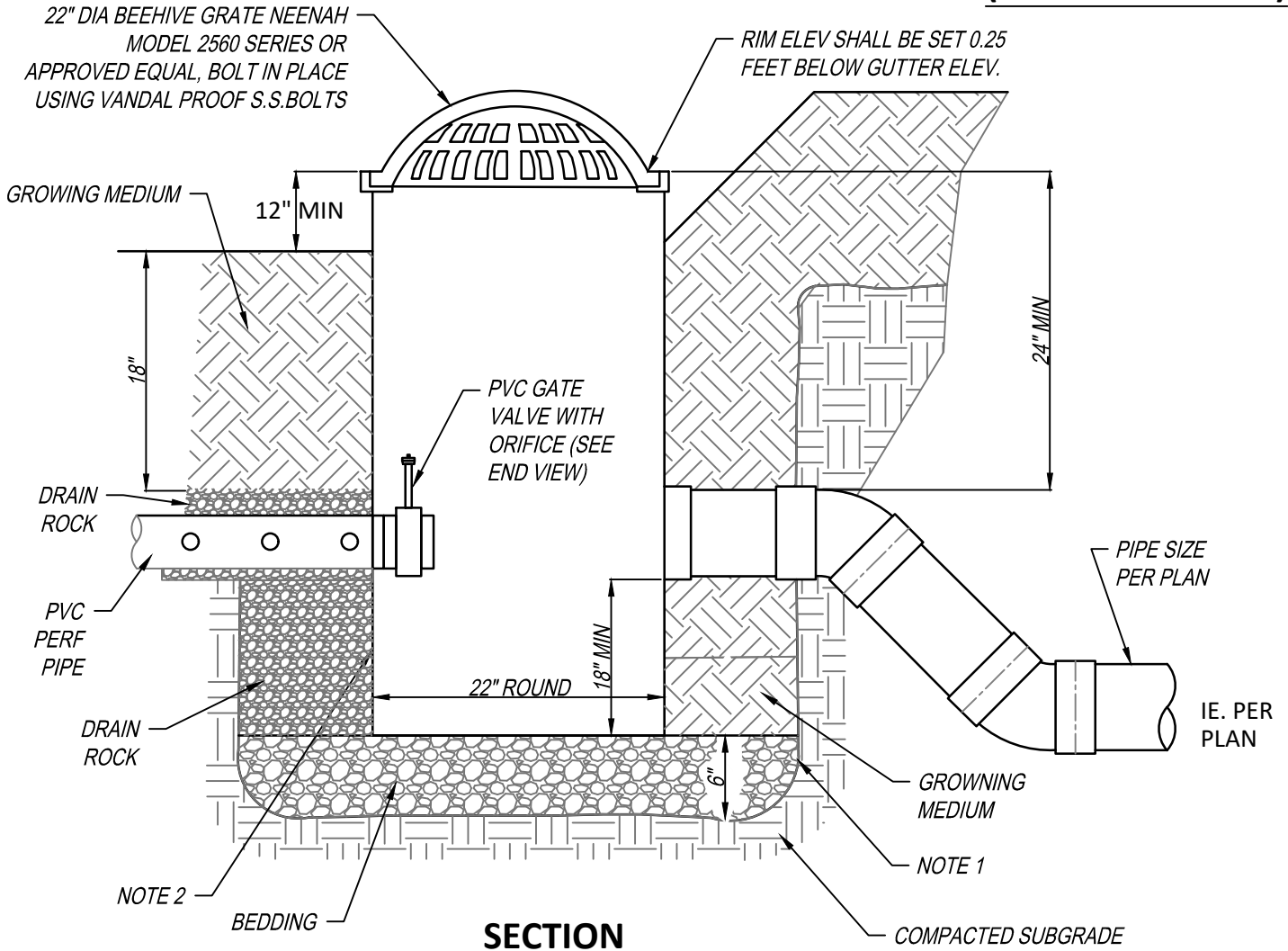

**SECTION**

**NOTES:**

1. CONTRACTOR TO WIDEN EXCAVATION AS REQUIRED TO OBTAIN COMPACTION WITH CONTRACTORS COMPACTION EQUIPMENT.
2. 10 GA. STEEL PLATE, BITUMINOUS COATED BASIN AS MANUFACTURED BY GIBSON STEEL, GRATEMASTER OR AS APPROVED BY CITY REPRESENTATIVE.
3. BEDDING SHALL BE 6" OF COMPACTED 3/4"-0 CRUSHED ROCK BASE MATERIAL.

Beehive Overflow Inlet			<b>CITY OF WILSONVILLE</b>   <b>PUBLIC WORKS STANDARDS</b>
DRAWING NUMBER: ST-6120	DRAWN BY: SR	SCALE: N.T.S.	
FILE NAME: ST-6120.dwg	APPROVED BY: NK	DATE: 2/15/18	





**TABLE A-2: STORMWATER FACILITY PLANT LISTS:  
RAIN GARDENS AND SWALES (INFILTRATION AND FILTRATION)**

Rain Gardens and Swales (infiltration and filtration)	Zone		Origin			Type/Size		Context Factors					
	Moisture zone (A) Uniformly wet to moist	Moisture zone (B) Drier transitional area	NW native	NW native cultivar	Non-native adapted	(E)vergreen/(D)eciduous	Potential height	Typical on center spacing	Facilities < 3 feet wide	Fully-lined facility	Parking areas	Streets	Adjacent to buildings
<b>Plant Name</b> <i>Botanical, common</i>													
<b>Herbaceous Plants</b>													
<i>Carex obnupta</i> , Slough sedge	•		•			E	48"	12"		•	•	•	•
<i>Carex testacea</i> , New Zealand orange sedge	•				•	D	24"	12"		•	•	•	•
<i>Deschampsia cespitosa</i> , Tufted hair grass	•		•			D	36"	12"	•	•	•	•	•
<i>Elymus glaucus</i> , Blue wild rye	•	•	•			E	24"	12"	•	•	•	•	•
<i>Juncus ensifolius</i> , Dagger-leaf rush	•				•	D	10"	12"	•	•	•	•	•
<i>Juncus patens</i> , Spreading rush	•	•			•	E	36"	12"	•	•	•	•	•
<i>Scirpus microcarpus</i> , Small fruited bulrush	•		•			E	24"	12"	•	•	•	•	•
<b>Small Shrubs/Groundcover</b>													
<i>Arctostaphylos uva-ursi</i> , Kinnickinnick		•	•			E	6"	12"	•	•	•	•	•
<i>Cornus sericea 'Kelsey'</i> , Kelsey dogwood	•	•		•		D	2'	12"	•	•	•	•	•
<i>Fragaria chiloensis</i> , Coastal strawberry		•	•			E	6"	12"	•	•	•	•	•
<i>Mahonia aquifolium</i> , Oregon grape	•	•	•			E	5'	3'		•	•	•	•
<i>Physocarpus capitatus</i> , Pacific ninebark	•		•			D	6'	3'		•			
<i>Polystichum munitum</i> , Sword fern	•	•	•			E	2'	2'	•	•	•	•	•
<i>Spirea betulifolia</i> , Birchleaf spiraea	•	•	•			D	2'	2'	•	•	•	•	•
<i>Symphoricarpos alba</i> , Snowberry	•	•	•			D	3'	3'	•	•	•	•	•
<b>Large Shrubs/Small Trees</b>													
<i>Cornus sericea</i> , Red-Twig dogwood	•	•	•			D	6'	4'					
<i>Holodiscus discolor</i> , Western serviceberry	•	•	•			D	6'	4'		•	•	•	
<i>Rosa nutkana</i> , Nootka rose	•	•	•			D	8'	4'		•		•	
<i>Omleria cerasiformis</i> , Indian plum	•		•			D	6'	4'		•	•	•	
<i>Ribes sanguineum</i> , Red flowering currant	•	•	•			D	8'	4'		•	•	•	•
<i>Salix sitchensis</i> , Sitka willow	•		•			D	15'	5'					
<i>Spirea douglasii</i> , Douglas spiraea		•	•			D	7'	4'		•	•	•	•
<b>Trees</b>													
<i>Acer circinatum</i> , Vine maple	•	•	•			D	15'	8'	•	•	•	•	•
<i>Alnus rubra</i> , Red alder	•	•	•			D	80'	20'					•
<i>Cornus nuttallii</i> , Pacific dogwood	•	•	•			D	20'	10'	•	•	•	•	•
<i>Fraxinus latifolia</i> , Oregon ash	•		•			D	30'	25'					
<i>Malus fusca</i> , Pacific crabapple	•		•			D	30'	10'	•	•			•
<i>Pseudotsuga menziesii</i> , Douglas fir	•	•	•			E	200'	30'					
<i>Thuja plicata</i> , Western red cedar	•	•	•			E	150'	20'			•		

**TABLE A-4: STORMWATER FACILITY PLANT LISTS:  
VEGETATED FILTER STRIPS**

Vegetated Filter Strips	Zone	Origin			Type/Size			Context Factors						
		Moisture zone (A/B) Dry to moist on slope	NW native	NW native cultivar	Non-native adapted	(E)vergreen/(D)eciduous	Potential height	Typical on center spacing	Facilities < 3' wide	Fully-lined facility	Parking areas	Streets	Adjacent to buildings	In buffer area
<b>Plant Name Botanical, Common</b>														
<b>Herbaceous Plants</b>														
<i>Aster suspicatus</i> , Douglas' aster	•	•			D	36"	12"	•	•	•	•	•	•	•
<i>Camassia quamash</i> , Camas lily	•	•			D	24"	12"	•	•	•	•	•	•	•
<i>Deschampsia caespitosa</i> , Tufted hair grass	•	•			D	36"	12"	•	•	•	•	•	•	•
<i>Festuca rubra</i> , Red fescue	•	•			E	24"	12"	•	•	•	•	•	•	•
<i>Elymus glaucus</i> , Blue wild rye	•	•			E	24"	12"	•	•	•	•	•	•	•
<i>Juncus patens</i> , Spreading rush	•			•	E	36"	12"	•	•	•	•	•	•	
<i>Lupinus polyhyllus</i> , Large-leaved lupine	•	•			D	36"	12"	•	•	•	•	•	•	•
<i>Sedum oreganum</i> , Oregon stonecrop	•	•			E	4"	12"	•	•	•	•	•	•	•
<i>Sisyrinchium californicum</i> , Yellow-eyed grass	•	•			E	4"	12"	•	•	•	•	•	•	•
<i>Veronica liwanensis</i> , Speedwell	•			•	D	2"	12"	•	•	•	•	•	•	
<b>Small Shrubs/Groundcover</b>														
<i>Cornus sericea</i> 'Kelsey', Kelsey dogwood	•		•		D	2'	12"	•	•	•	•	•	•	
<i>Fragaria chiloensis</i> , Coastal strawberry	•	•			E	6"	12"	•	•	•	•	•	•	•
<i>Gaultheria shallon</i> , Salal	•	•			E	24"	24"	•	•	•	•	•	•	•
<i>Mahonia aquifolium</i> , Oregon grape	•	•			E	5'	3'		•	•	•	•	•	•
<i>Physocarpus capitatus</i> , Pacific ninebark	•	•			D	6'	3'		•					•
<i>Polystichum munitum</i> , Sword fern	•	•			E	2'	2'	•	•	•	•	•	•	•
<i>Rosa pisocarpa</i> , Swamp rose	•	•			D	8'	3'		•	•				•
<i>Spirea betulifolia</i> , Birchleaf spiraea	•	•			D	2'	2'	•	•	•	•	•	•	•
<i>Symphoricarpus alba</i> , Snowberry	•	•			D	3'	3'	•	•	•	•	•	•	•
<b>Large Shrubs/Small Trees</b>														
<i>Cornus sericea</i> , Red-Twig dogwood	•	•			D	6'	4'							•
<i>Holodiscus discolor</i> , Western serviceberry	•	•			D	6'	4'		•	•	•			•
<i>Omleria cerasiformis</i> , Indian plum	•	•			D	6'	4'		•	•	•			•
<i>Ribes Sanguineum</i> , Red flowering currant	•	•			D	8'	4'		•	•	•	•	•	•
<i>Salix stichensis</i> , Sitka willow	•	•			D	15'	5'							•
<i>Salix purpurea nana</i> , Blue arctic willow	•			•	D	8'	6'			•	•	•	•	
<i>Ceanothus sanguineum</i> , Redstem ceanothus	•	•			E	7'	3'		•	•	•	•	•	•

**TABLE A-4: STORMWATER FACILITY PLANT LISTS:  
VEGETATED FILTER STRIPS**

Vegetated Filter Strips	Zone	Origin			Type/Size			Context Factors						
		Moisture zone (A/B) Dry to moist on slope	NW native	NW native cultivar	Non-native adapted	(E)vergreen/(D)eciduous	Potential height	Typical on center spacing	Facilities < 3' wide	Fully-lined facility	Parking areas	Streets	Adjacent to buildings	In buffer area
<b>Plant Name</b> <b>Botanical, Common</b>														
<b>Trees</b>														
<i>Acer circinatum</i> , Vine maple	•	•			D	15'	8'	•	•	•	•	•	•	
<i>Alnus Rubra</i> , Red alder	•	•			D	80'	20'					•	•	
<i>Cornus nuttallii</i> , Pacific dogwood	•	•			D	20'	10'	•	•	•	•	•	•	
<i>Fraxinus Latifolia</i> , Oregon ash	•	•			D	30'	25'						•	
<i>Malus Fusca</i> , Pacific crabapple	•	•			D	30'	10'	•	•			•	•	
<i>Pseudotsuga menziesii</i> , Douglas fir	•	•			E	200'	30'						•	
<i>Thuja plicata</i> , Western red cedar	•	•			E	150'	20'			•			•	



- (d) Plant tagging for identification
  - (e) Plant protection
  - (f) Seeding mix, methods, rates, and areas
3. Irrigation plan and specifications, including identification of water source, and, maintenance of the system.
  4. Maintenance schedule; including responsible party and contact information, dates of inspection (minimum three per growing season and one prior to onset of growing season) and estimated maintenance schedule (as necessary) over the 2-year monitoring period.
  5. Access points for installation and maintenance including vehicle access if required.
  6. Standard drawing details (north arrow, scale bar, property boundaries, project name, drawing date, name of designer and Property Owner).

**A.4.00 Stormwater Facility Growing Medium**

Furnish imported growing medium for vegetated stormwater management facilities conforming to the following:

- a. Standard Blend: Use this blend for all vegetated stormwater management facilities, except those in the right-of-way where compaction from foot traffic is a concern.
  1. General Composition: The medium shall be a blend of loamy soil, sand, and compost that is 30 to 40 percent compost (by volume) and meets the criteria in this specification.
  2. Analysis Requirements for the Blended Material:
    - (a) Particle Gradation: A particle gradation analysis of the blended material, including compost, shall be conducted in conformance with ASTM C1 17/C136 (AASHTO T1 1/T27). The analysis shall include the following sieve sizes: 1 inch, 3/8 inch, #4, #10, #20, #40, #60, #100, and #200. The gradation of the blend shall meet the following gradation criteria.

Sieve Size	Percent Passing
1 inch	100
# 4	60 -100
# 10	40-100
# 40	15-50

# 100	5-25
# 200	3-5

- (b) The blend shall have a Coefficient of Uniformity (D60/D10) equal to or greater than 6 to ensure that it is well graded (has a broad range of particle sizes). The coefficient is the ratio of two particle diameters on a grain-size distribution curve; it is the particle diameter at 60 percent passing divided by the particle diameter at 10 percent passing.
3. **Organic Matter Content:** An analysis of soil organic matter content shall be conducted in conformance with ASTM D2974 (loss on ignition test). The soil organic matter content shall be a minimum of 10 percent, as reported by that test.
  4. **Measured pH:** The blended material shall be tested and have a pH of 5.5 to 7.
- b. **Infiltration Blend for the Right-of-Way:** Use this blend for facilities in the right-of-way where compaction from foot traffic is a concern. Approval is required.
1. **General Composition:** The medium shall be a mix of sand and compost, blended by volume. The medium shall consist of 60 to 70 percent sand and 30 to 40 percent compost (by volume).
  2. **Analysis Requirements:** The requirements are the same as those specified in Section A.4.00.a for the “Standard Blend.” The single difference is the particle gradation criteria, which are as follows.

<b>Sieve Size</b>	<b>Percent Passing</b>
1 inch	100
# 4	60-100
# 10	40-100
# 40	15-50
# 100	5-20
# 200	3-5

c. General Requirements for the Blended Material:

1. The material shall be loose and friable.
2. It shall be well mixed and homogenous.
3. It shall be free of wood pieces, plastic, screened and free of stones 1 inch (25 mm) or larger in any dimension; free of roots, plants, sod, clods, clay lumps, pockets of coarse sand, paint, paint washout, concrete slurry, concrete layers or chunks, cement, plaster, building debris, oils, gasoline, diesel fuel, paint thinner, turpentine, tar, roofing compound, acid, and other extraneous materials harmful to plant growth; free of weeds and invasive plants including but not limited to:
  - (a) *Cirsium arvense* (Canadian Thistle)
  - (b) *Convolvulus* spp. (Morning Glory)
  - (c) *Cytisus scoparius* (Scotch Broom)
  - (d) *Dipsacus sylvestris* (Common Teasel)
  - (e) *Festuca arundinaceae* (Tall Fescue)
  - (f) *Hedera helix* (English Ivy)
  - (g) *Holcus canatus* (Velvet Grass)
  - (h) *Lolium* spp. (Rye Grasses)
  - (i) *Lotus corniculatus* (Bird's Foot Trefoil)
  - (j) *Lythrium salicaria* (Purple Loose Strife)
  - (k) *Melilotus* spp. (Sweet Clover)
  - (l) *Myriophyllum spicatum* (Eurasian Milfoil)
  - (m) *Phalaris arundinaceae* (Reed Canary Grass)
  - (n) *Rubus discolor* (Himalayan Blackberry)
  - (o) *Solanum* spp. (Nightshade)
  - (p) *Trifolium* spp. (Clovers), and
  - (q) Not infested with nematodes, grubs, other pests, pest eggs, or other undesirable organisms and disease-causing plant pathogens; friable and with sufficient structure to give good tilth and aeration. Continuous, air-filled, pore-space content on a volume/volume basis shall be at least 15 percent when

moisture is present at field capacity. Soil shall have a field capacity of at least 15 percent on a dry weight basis.

4. It shall have no visible free water.
  5. It shall be obtained from naturally well drained construction or mining sites where topsoil occurs at least 4 inches deep; it shall not be obtained from bogs, wetlands, or marshes.
- d. Compost: The compost shall be derived from plant material and provided by a member of the U.S. Composting Council Seal of Testing Assurance (STA) program. See [www.compostingcouncil.org](http://www.compostingcouncil.org) for a list of providers in Portland.
1. The compost shall be the result of the biological degradation and transformation of plant- derived materials under conditions designed to promote aerobic decomposition. The material shall be well composted, free of viable weed seeds, and stable with regard to oxygen consumption and carbon dioxide generation. The compost shall have no visible free water and produce no dust when handled. It shall meet the following criteria, as reported by the U.S. Composting Council STA Compost Technical Data Sheet provided by the vendor:
    - (a) 100 percent of the material must pass through a 1/2-inch screen.
    - (b) The pH of the material shall be between 6 and 8.
    - (c) Manufactured inert material (plastic, concrete, ceramics, metal, etc.) shall be less than 1.0 percent by weight.
    - (d) The organic matter content shall be between 35 and 65 percent.
    - (e) The soluble salt content shall be less than 6.0 mmhos/cm.
    - (f) Germination (an indicator of maturity) shall be greater than 80 percent.
    - (g) The stability shall be between classes 5-7.
    - (h) The carbon/nitrogen ratio shall be less than 25:1.
    - (i) The trace metals test result = “pass.”
- e. Submittals: At least 14 working days in advance of construction, submit the following:
1. Documentation for the three analyses (particle gradation with calculated coefficient of uniformity; organic matter content; pH) described in this specification. The analyses shall be performed by an accredited laboratory with certification maintained current. The date of the analyses shall be no more than 90 calendar days prior to the date of the submittal. The report shall include the following information:



- (a) Name and address of the laboratory
  - (b) Phone contact and e-mail address for the laboratory
  - (c) Test data, including the date and name of the test procedure
2. A compost technical data sheet from the vendor of the compost. The analysis and report must be consistent with the sampling and reporting requirements of the U.S. Composting Council STA program. The analysis shall be performed and reported by an approved independent STA program laboratory.
  3. The date of the analysis shall be no more than 90 calendar days prior to the date of the submittal.
  4. A description of the location, equipment, and method proposed to mix the material.
- f. Stormwater Management Facility Growing Medium Installation
1. Protection of the Growing Medium: The growing medium shall be protected from all sources of contamination, including weed seeds, while at the supplier, in conveyance, and at the project site.
  2. Placement of the Growing Medium: The medium shall be placed in loose lifts, not to exceed 8 inches and each lift shall be compacted with a water-filled landscape roller. The material shall not otherwise be mechanically compacted.
  3. Timing of Plant Installation: Weather permitting, plants shall be installed as soon as possible after placing and grading the growing medium in order to minimize erosion and further compaction.
  4. Erosion Control: Temporary erosion control measures are required until permanent stabilization measures are functional, including protection of overflow structures.
  5. Protection of the Facility: In all cases, the facility must be protected from foot or equipment traffic that is unrelated to the construction of the facility. Temporary fencing or walkways should be installed as needed to keep workers, pedestrians, and equipment out of the facility. Under no circumstances should materials and equipment be stored in the facility.
  6. Stormwater management facilities shall be kept clean and shall not be used as erosion and sediment control structures during construction.
  7. Wet and Winter Conditions: Placement of the growing medium will not be allowed when the ground is frozen or saturated or when the weather is determined to be too wet.
- g. Watering, Fertilizing, and Mulching

1. Water all plants during establishment to maintain all plantings in a healthy thriving condition.
2. Fertilizers should generally be avoided in stormwater facilities. Fertilize all plants during establishment as needed with slow release, organic (low yield) material.
3. The purpose of mulching soils is to conserve moisture, hold plantings and topsoil in place, limit weed establishment and moderate soil temperatures.
4. Mulch for Vegetated Stormwater Facilities: The use of mulch in frequently inundated areas shall be limited to avoid any possible water quality impacts including the leaching of tannins and nutrients, and the migration of mulch into waterways. Mulches to be used shall be a stable and inert (non-leaching) matter of sufficient mass and density that it will not float in standard flows. Mulch cover should be maintained throughout the life of the stormwater facility with minimum thickness of 2 inches in depth.

#### h. Stormwater Facility Plant Lists

1. The plant lists provided in the following tables are separated by facility type (such as planters, rain gardens, green roof, etc.). Each facility list includes a suitability matrix for limiting contextual factors (such as moisture zones and width of facility) as well as a listing of specific characteristics for each species, such as native to the area, if it is an evergreen, its average height and the on-center spacing.
2. The following characteristics are included in plant matrices to aid in plant selection:
  - (a) Botanical name, Common Name: Plants are listed by their botanical name first, in italics, followed by a generally accepted common name. Note that common names vary, so use of the botanical name is recommended to ensure proper plant selection
  - (b) Zone: Denotes the planting moisture zone as noted in the facility diagrams in Figure A-1. Some plants work in multiple moisture zones, and others only in a particular dry, moist, or wet condition.
  - (c) Origin: The distinction between Northwest native plants, cultivated varieties of Northwest Natives, and plants that are non-native but adapted to our specific climate.
  - (d) Type/Size: A range of factors to aid in plant selection showing individual plant characteristics:
    - (1) (E)vergreen/(D)eciduous: Identifies the characteristic of a plant to keep foliage during winter months. Planting placement and selection should maintain a balance of evergreen and deciduous materials.

- (2) Potential Height: Maximum size at maturity to use as a design guideline.
- (3) On-Center Spacing: Optimum spacing for new plantings. This is to be used as a guideline and may vary slightly depending on site conditions.

(e) Context Factors

- (1) Facilities less than 3 feet wide: Narrow conditions require plants that are not too large and will outgrow or have potential for roots to damage, narrow planters.
- (2) Fully Lined Facility: Limit larger material or plants with aggressive roots.
- (3) Parking Area: Use plant materials that do not limit necessary line of sight visibility.
- (4) Streets: Use plant materials that do not limit necessary line of sight visibility.
- (5) Adjacent to Buildings: Limit plants that are too large for areas next to buildings and would not be compatible with building footings, windows or other systems.





# Storm Water Blend 2.3

PLANTING SOIL SPECIALISTS SINCE 1968

## **PRO-GRO STORM WATER BLEND 2.3 CONTAINS:**

**Screened Sand, Soil Life, Type 1, Compost, Screened Sandy loam**

This product meets the City of Portland Storm Water Specifications.

### **Sandy Loam – A natural, clean source located in Oregon**

This is a true Willamette Valley Sandy Loam, not a clay and sand blend.

This naturally occurring material is harvested within 10 miles from Pro-Gro Mixes production facility.

### **Soil Life Compost – Green waste compost produced in Oregon**

The compost is derived from plant material and provided by a member of the US Composting Council Seal of Testing Assurance (STA) program. The compost percentage in the blend is 30% to 40% by volume.

This Organic, OMRI listed, compost is produced within 50 miles from the Pro-Gro Mixes production facility.

### **Screened Sand – A local source of Graded Sand**

This is clean, washed, sand that is screened to meet the gradation specifications.

The material supplier is located less than 50 miles from Pro-Gro Mixes production Facility.

**Finished Blend has a PH range between 6 and 8**

### **Pro-Gro Mixes Production Facility is located at:**

26045 SW Grahams Ferry Road  
Sherwood, Oregon 97140  
503-682-3500

## TECHNICAL REPORT

**Report To:** Mr. Dave Andrews  
 Pro Gro Mixes & Materials  
 PO Box 1127  
 Tualatin, Oregon 97062

**Date:** 2/2/18

**Lab No.:** 18-023

**Project:** Laboratory Testing

**Project No.:** 2413.1.1

**Report of:** Sieve analysis – Stormwater

### Sample Identification

As requested, NTI provided sieve analysis on one sample delivered to our laboratory on January 31, 2018 by a Pro Gro Mixes & Materials representative. All testing was performed in general accordance with the methods indicated. Our laboratory's test results are summarized on the following table.

### Laboratory Test Results

Sieve Analysis of Aggregate (AASHTO T27/T11)		
Sieve Size	Percent Passing	Specification
3/8"	100	--
1/4"	100	--
#4	98	75 – 100
#8	82	--
#10	79	40 – 100
#16	70	--
#30	57	--
#40	46	15 – 50
#50	32	--
#100	14	5 – 25
#200	7.1	5 – 15

**Copies:** Addressee



**Turf & Soil Diagnostics**

Pro-Gro Mixes & Materials  
 Dave Andrews  
 26045 SW Grahams Ferry Road  
 Tualatin, OR 97062

Date Received Aug-12-2016  
 Date Reported Aug-25-2016  
 Facility Product Development

**Maximum Media Density for Dead Load Analysis of Green Roof Systems †**

Lab ID#	Sample Name	Water Permeability (Saturated Hydraulic Conductivity)		Initial Media Density (Application Density)		Maximum Media Density (Saturated Density)		Maximum Media Water Retention (%)	Dry Media Density	
		(in/hr)	(mm/min)	(lb/ft <sup>3</sup> )	(g/cm <sup>3</sup> )	(lb/ft <sup>3</sup> )	(g/cm <sup>3</sup> )		(lb/ft <sup>3</sup> )	(g/cm <sup>3</sup> )
16080070-2	Storm Water	24.0	10.2	92.6	1.48	113.6	1.82	52	81.7	1.31

Lab ID#	Sample Name	Initial Sample Wt. (Kg)	Sample Volume (m <sup>3</sup> )	Initial Sample Height (cm)	Final Sample Height (cm)	Sample Wt. After Draining (Kg)	Total Pore Space (%)	Air-filled Porosity** (%)	pH***	Electrical Conductivity mmhos/cm	Organic Matter** (%)
16080070-2	Storm Water	2.708	0.0018	10.1	10.3	3.3	51	-1	6.6	0.1	6.2

**Particle Size Evaluation\***

Lab ID#	Sample Name	% Sand 2.0 - 0.063 mm	% Silt 0.063-0.002 mm	% Clay < 0.002mm	% Passing US sieve (mm)					
					Gravel 3/8"	Gravel 1/8" (3.17)	Gravel 10 (2.0)	V. Coarse 18 (1.0)	Medium 60 (0.25)	V. Fine 230 (0.063)
16080070-2	Storm Water	63.0	7.4	4.0	100.0	85.7	74.4	64.4	26.5	11.1

† ASTM E2399 †† At Maximum Media Density (Water-holding Capacity)

\*\*\* ASTM D4972 w CaCl<sub>2</sub> (not screened)

\* ASTM F1632 Method B

\*\* Ashed at 550° C (FLL Guidelines)

Samples were tested as received and comments pertain only to the samples shown.

This report may not be reproduced in part, but only in full.

Sample condition upon receipt was normal.

Samples were received with a transmittal letter.

**Duane Otto**

Digitally signed by Duane Otto  
 DN: cn=Duane Otto, o=Turf and  
 Soil Diagnostics, ou,  
 email=duane@turfdiag.com, c=US  
 Date: 2016.08.25 17:37:36 -05'00'

Reviewed by \_\_\_\_\_





## Rain Gardens Operations & Maintenance Plan

What to Look For	What to Do
<b>Structural Components, including inlets and outlets/overflows, shall freely convey stormwater.</b>	
Clogged inlets or outlets	-Remove sediment and debris from catch basins, trench drains and curb inlets and pipes to maintain at least 50% conveyance capacity at all times.
Cracked Drain Pipes	-Repair/seal cracks. Replace when repair is insufficient.
Check Dams	-Maintain 4 to 10 inch deep rock check dams at design intervals.
<b>Vegetation</b>	
Dead or strained vegetation	-Replant per original planting plan, or substitute from Appendix A. -Irrigate as needed. Mulch banks annually. DO NOT apply fertilizers, herbicides, or pesticides.
Tall Grass and Vegetation	-Cut back grass and prune overgrowth 1-2 times per year. Remove cuttings
Weeds	-Manually remove weeds. Remove all plant debris.
<b>Growing/Filter Medium, including soil and gravels, shall sustain healthy plant cover and infiltrate within 72 hours.</b>	
Gullies	-Fill, lightly compact, and plant vegetation to disperse flow.
Erosion	-Replace splash blocks or inlet gravel/rock.
Slope Slippage	-Stabilize 3:1 slopes/banks with plantings from Appendix A
Ponding	-Rake, till, or amend to restore infiltration rate.

### Annual Maintenance Schedule:

*Summer.* Make any structural repairs. Improve filter medium as needed. Clear drain. Irrigate as needed.

*Fall.* Replant exposed soil and replace dead plants. Remove sediment and plant debris.

*Winter.* Monitor infiltration/flow-through rates. Clear inlets and outlets/overflows to maintain conveyance.

*Spring.* Remove sediment and plant debris. Replant exposed soil and replace dead plants. Mulch.

*All seasons.* Weed as necessary.

*Maintenance Records:* Record date, description, and contractor (if applicable) for all structural repairs, landscape maintenance, and facility cleanout activities. Keep work orders and invoices on file and make available upon request of the inspector.

*Access:* Maintain ingress/egress to design standards.

*Infiltration/Flow Control:* All facilities shall drain within 72 hours. Record time/date, weather, and site conditions when ponding occurs.

*Pollution Prevention:* All sites shall implement best management practices to prevent hazardous or solid wastes or excessive oil and sediment from contaminating stormwater. Contact \_\_\_\_\_ for immediate assistance responding to spills. Record time/date, weather, and site conditions if site activities contaminate stormwater.

*Vectors (Mosquitoes & Rodents):* Stormwater facilities shall not harbor mosquito larvae or rats that pose a threat to public health or that undermine the facility structure. Monitor standing water for small wiggling sticks perpendicular to the water's surface. Note holes/burrows in and around facilities. Call Clackamas County Vector Control for immediate assistance to eradicate vectors. Record time/date, weather, and site conditions when vector activity observed.

### Rain Garden O & M Plan

DRAWING NUMBER: ST-6030

DRAWN BY: SR

SCALE: N.T.S.

FILE NAME: ST-6030.DWG

APPROVED BY: NK

DATE: 10/15/14

CITY OF  
WILSONVILLE



PUBLIC WORKS STANDARDS

## Vegetated Swales Operations & Maintenance Plan

What to Look For	What to Do
<b>Structural Components, including inlets and outlets/overflows, shall freely convey stormwater.</b>	
Clogged inlets or outlets	-Remove sediment and debris from catch basins, trench drains, curb inlets and pipes to maintain at least 50% conveyance capacity at all times.
Cracked Drain Pipes	-Replace/seal cracks. Replace when repair is insufficient.
Check Dams	-Maintain 4 - 10 inch deep rock check dams at design intervals.
<b>Vegetation</b>	
Dead or strained vegetation	-Replant per original planting plan, or substitute from Appendix A. -Irrigate as needed. Mulch banks annually. DO NOT apply fertilizers, herbicides, or pesticides.
Tall Grass and Vegetation	-Cut back to 4-6 inches, 1-2 times per year. Remove cuttings
Weeds	-Manually remove weeds. Remove all plant debris.
<b>Growing/Filter Medium, including soil and gravels, shall sustain healthy plant cover and infiltrate within 72 hours.</b>	
Gullies	-Fill, lightly compact, and plant vegetation to disperse flow.
Erosion	-Restore or create outfalls, checkdams, or splash blocks where necessary.
Slope Sippage	-Stabilize Slope.
Ponding	-Rake, till, or amend to restore infiltration rate.

### Annual Maintenance Schedule:

*Summer.* Make any structural repairs. Improve filter medium as needed. Clear drain. Irrigate as needed.

*Fall.* Replant exposed soil and replace dead plants. Remove sediment and plant debris.

*Winter.* Monitor infiltration/flow-through rates. Clear inlets and outlets/overflows to maintain conveyance.

*Spring.* Remove sediment and plant debris. Replant exposed soil and replace dead plants. Mulch.

*All seasons.* Weed as necessary.

**Maintenance Records:** Record date, description, and contractor (if applicable) for all structural repairs, landscape maintenance, and facility cleanout activities. Keep work orders and invoices on file and make available upon request of the inspector.

**Access:** Maintain ingress/egress to design standards.

**Infiltration/Flow Control:** All facilities shall drain within 72 hours. Record time/date, weather, and site conditions when ponding occurs.

**Pollution Prevention:** All sites shall implement best management practices to prevent hazardous or solid wastes or excessive oil and sediment from contaminating stormwater. Contact \_\_\_\_\_ for immediate assistance responding to spills. Record time/date, weather, and site conditions if site activities contaminate stormwater.

**Vectors (Mosquitoes & Rodents):** Stormwater facilities shall not harbor mosquito larvae or rats that pose a threat to public health or that undermine the facility structure. Monitor standing water for small wiggling sticks perpendicular to the water's surface. Note holes/burrows in and around facilities. Call Clackamas County Vector Control for immediate assistance to eradicate vectors. Record time/date, weather, and site conditions when vector activity observed.

### Vegetated Swale O & M Plan

DRAWING NUMBER: ST-6055

DRAWN BY: SR

SCALE: N.T.S.

FILE NAME: ST-6055.DWG

APPROVED BY: NK

DATE: 10/8/14

CITY OF  
WILSONVILLE



PUBLIC WORKS STANDARDS

## Vegetated Filter Strips Operations & Maintenance Plan

What to Look For	What to Do
<b>Structural Components</b> , including inlets and outlets/overflows, shall freely convey stormwater.	
Clogged inlets or outlets	-Remove sediment and debris from trench drains and curb inlets to maintain at least 50% conveyance capacity at all times.
Ineffective flow-spreaders	-Clear accumulated silt
Check Dams	-Maintain 4 to 10 inch deep rock check dams at design intervals
<b>Vegetation</b>	
Dead or strained vegetation	-Replant per original planting plan, or substitute from Appendix A. -Irrigate as needed. DO NOT apply fertilizers, herbicides, or pesticides.
Tall Grass and Vegetation	-Cut back to 4-6 inches, 1-2 times per year. Remove cuttings
Weeds	-Manually remove weeds. Remove all plant debris.
<b>Growing/Filter Medium</b> , including soil and gravels, shall sustain healthy plant cover	
Ponding	-Rake, till, or amend to restore infiltration rate.
Gullies	-Fill, lightly compact, and plant vegetation to disperse flow.
Erosion	-Restore or create outfalls, checkdams, or splash blocks where necessary.
Slope Slippage	-Stabilize Slope

### Annual Maintenance Schedule:

*Summer.* Make any structural repairs. Improve filter medium as needed. Irrigate as needed.

*Fall.* Replant exposed soil and replace dead plants. Remove sediment and plant debris.

*Winter.* Monitor flow-through rates. Clear inlets to maintain conveyance.

*Spring.* Remove sediment and plant debris. Replant exposed soil and replace dead plants. Mulch.

All seasons. Weed as necessary.

*Maintenance Records:* Record date, description, and contractor (if applicable) for all structural repairs, landscape

maintenance, and facility cleanout activities. Keep work orders and invoices on file and make available upon request of the inspector.

*Access:* Maintain ingress/egress to design standards.

*Pollution Prevention:* All sites shall implement best management practices to prevent hazardous or solid wastes or excessive oil and sediment from contaminating stormwater. Contact \_\_\_\_\_ for immediate assistance responding to spills. Record time/date, weather, and site conditions if site activities contaminate stormwater.

*Vectors (Mosquitoes & Rodents):* Stormwater facilities shall not harbor mosquito larvae or rats that pose a threat to public health or that undermine the facility structure. Monitor standing water for small wiggling sticks perpendicular to the water's surface. Note holes/burrows in and around facilities. Call Clackamas County Vector Control for immediate assistance to eradicate vectors. Record time/date, weather, and site conditions when vector activity observed.

### Vegetated Filter Strips O & M Plan

CITY OF  
WILSONVILLE



PUBLIC WORKS STANDARDS

DRAWING NUMBER: ST-6040

DRAWN BY: SR

SCALE: N.T.S.

FILE NAME: ST-6040.DWG

APPROVED BY: NK

DATE: 10/8/14



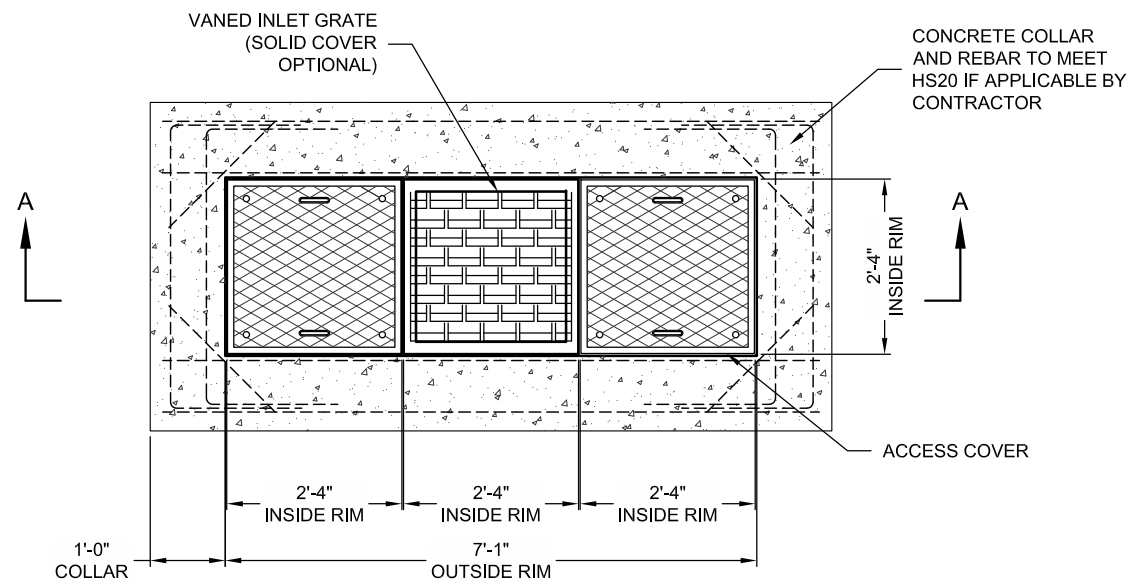

**PLAN VIEW**

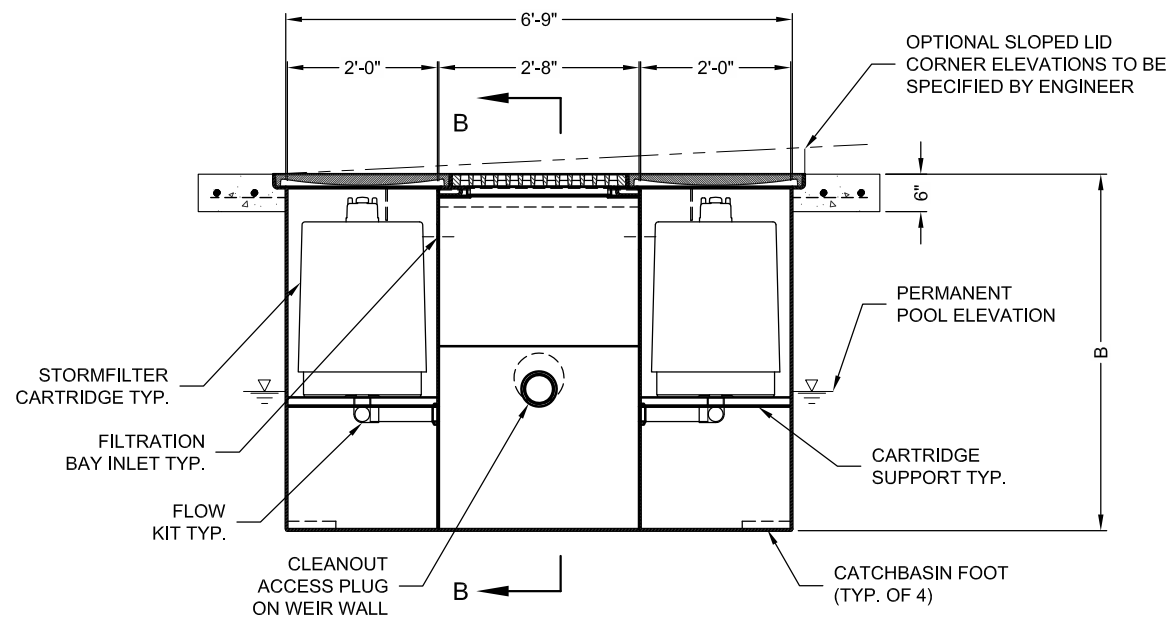

**SECTION A-A**

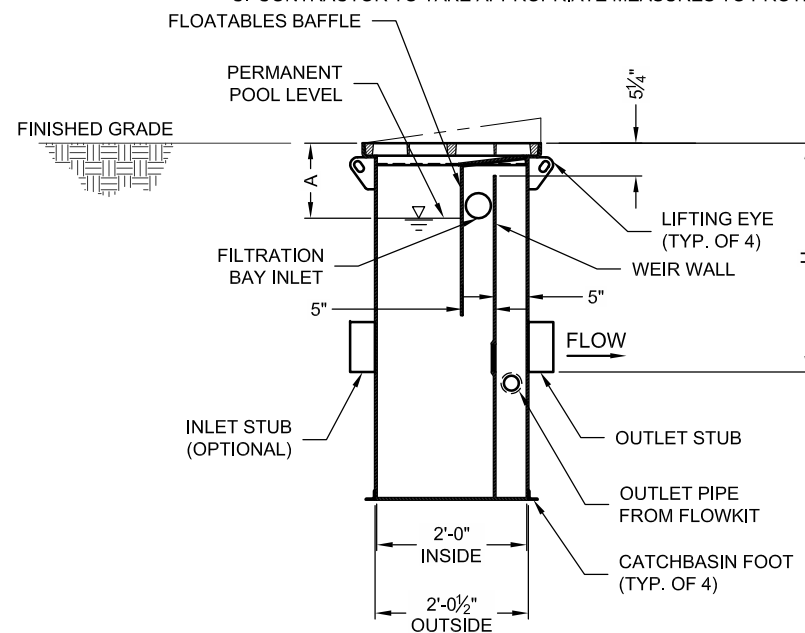

**SECTION B-B**

**STORMFILTER STEEL CATCHBASIN DESIGN NOTES**

STORMFILTER TREATMENT CAPACITY IS A FUNCTION OF THE CARTRIDGE SELECTION AND THE NUMBER OF CARTRIDGES. 2 CARTRIDGE CATCHBASIN HAS A MAXIMUM OF TWO CARTRIDGES. SYSTEM IS SHOWN WITH A 27" CARTRIDGE, AND IS ALSO AVAILABLE WITH AN 18" CARTRIDGE. STORMFILTER CATCHBASIN CONFIGURATIONS ARE AVAILABLE WITH A DRY INLET BAY FOR VECTOR CONTROL. PEAK HYDRAULIC CAPACITY PER TABLE BELOW. IF THE SITE CONDITIONS EXCEED PEAK HYDRAULIC CAPACITY, AN UPSTREAM BYPASS STRUCTURE IS REQUIRED.

**CARTRIDGE SELECTION**

CARTRIDGE HEIGHT	27"			18"			18" DEEP		
RECOMMENDED HYDRAULIC DROP (H)	3.05'			2.3'			3.3'		
SPECIFIC FLOW RATE (gpm/sf)	2 gpm/sf	1.67* gpm/sf	1 gpm/sf	2 gpm/sf	1.67* gpm/sf	1 gpm/sf	2 gpm/sf	1.67* gpm/sf	1 gpm/sf
CARTRIDGE FLOW RATE (gpm)	22.5	18.79	11.25	15	12.53	7.5	15	12.53	7.5
PEAK HYDRAULIC CAPACITY	1.0			1.0			1.8		
INLET PERMANENT POOL LEVEL (A)	1'-0"			1'-0"			2'-0"		
OVERALL STRUCTURE HEIGHT (B)	4'-9"			3'-9"			4'-9"		

\* 1.67 gpm/sf SPECIFIC FLOW RATE IS APPROVED WITH PHOSPHOSORB® (PSORB) MEDIA ONLY

**GENERAL NOTES**

- CONTECH TO PROVIDE ALL MATERIALS UNLESS NOTED OTHERWISE.
- FOR SITE SPECIFIC DRAWINGS WITH DETAILED STORMFILTER CATCHBASIN STRUCTURE DIMENSIONS AND WEIGHTS, PLEASE CONTACT YOUR CONTECH ENGINEERED SOLUTIONS LLC REPRESENTATIVE. WWW.CONTECHES.COM
- STORMFILTER CATCHBASIN WATER QUALITY STRUCTURE SHALL BE IN ACCORDANCE WITH ALL DESIGN DATA AND INFORMATION CONTAINED IN THIS DRAWING.
- INLET SHOULD NOT BE LOWER THAN OUTLET. INLET (IF APPLICABLE) AND OUTLET PIPING TO BE SPECIFIED BY ENGINEER AND PROVIDED BY CONTRACTOR.
- MANUFACTURER TO APPLY A SURFACE BEAD WELD IN THE SHAPE OF THE LETTER "O" ABOVE THE OUTLET PIPE STUB ON THE EXTERIOR SURFACE OF THE STEEL SFCB.
- STORMFILTER CATCHBASIN EQUIPPED WITH 4 INCH (APPROXIMATE) LONG STUBS FOR INLET (IF APPLICABLE) AND OUTLET PIPING. STANDARD OUTLET STUB IS 8 INCHES IN DIAMETER. MAXIMUM OUTLET STUB IS 15 INCHES IN DIAMETER. CONNECTION TO COLLECTION PIPING CAN BE MADE USING FLEXIBLE COUPLING BY CONTRACTOR.
- STEEL STRUCTURE TO BE MANUFACTURED OF 1/4 INCH STEEL PLATE. CASTINGS SHALL MEET AASHTO M306 LOAD RATING. TO MEET HS20 LOAD RATING ON STRUCTURE, A CONCRETE COLLAR IS REQUIRED. WHEN REQUIRED, CONCRETE COLLAR WITH #4 REINFORCING BARS TO BE PROVIDED BY CONTRACTOR.
- FILTER CARTRIDGES SHALL BE MEDIA-FILLED, PASSIVE, SIPHON ACTUATED, RADIAL FLOW, AND SELF CLEANING. RADIAL MEDIA DEPTH SHALL BE 7-INCHES. FILTER MEDIA CONTACT TIME SHALL BE AT LEAST 38 SECONDS.
- SPECIFIC FLOW RATE IS EQUAL TO THE FILTER TREATMENT CAPACITY (gpm) DIVIDED BY THE FILTER CONTACT SURFACE AREA (sq ft).

**INSTALLATION NOTES**

- ANY SUB-BASE, BACKFILL DEPTH, AND/OR ANTI-FLOTATION PROVISIONS ARE SITE-SPECIFIC DESIGN CONSIDERATIONS AND SHALL BE SPECIFIED BY ENGINEER OF RECORD.
- CONTRACTOR TO PROVIDE EQUIPMENT WITH SUFFICIENT LIFTING AND REACH CAPACITY TO LIFT AND SET THE CATCHBASIN (LIFTING CLUTCHES PROVIDED).
- CONTRACTOR TO TAKE APPROPRIATE MEASURES TO PROTECT CARTRIDGES FROM CONSTRUCTION-RELATED EROSION RUNOFF.

**2-CARTRIDGE DEEP CATCHBASIN STORMFILTER DATA**

STRUCTURE ID	XXX
WATER QUALITY FLOW RATE (cfs)	X.XX
PEAK FLOW RATE (<1.8 cfs)	X.XX
RETURN PERIOD OF PEAK FLOW (yrs)	XXX
CARTRIDGE FLOW RATE (gpm)	XX
MEDIA TYPE (PERLITE, ZPG, PSORB)	XXXXX
RIM ELEVATION	XXX.XX'

PIPE DATA:	I.E.	DIAMETER
INLET STUB	XXX.XX'	XX"
OUTLET STUB	XXX.XX'	XX"

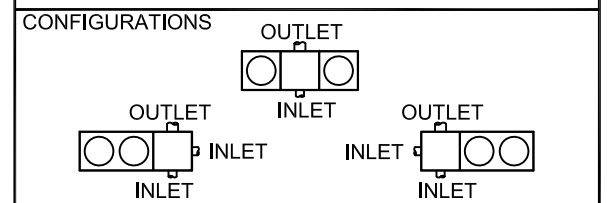

SLOPED LID	YES/NO
SOLID COVER	YES/NO
NOTES/SPECIAL REQUIREMENTS:	

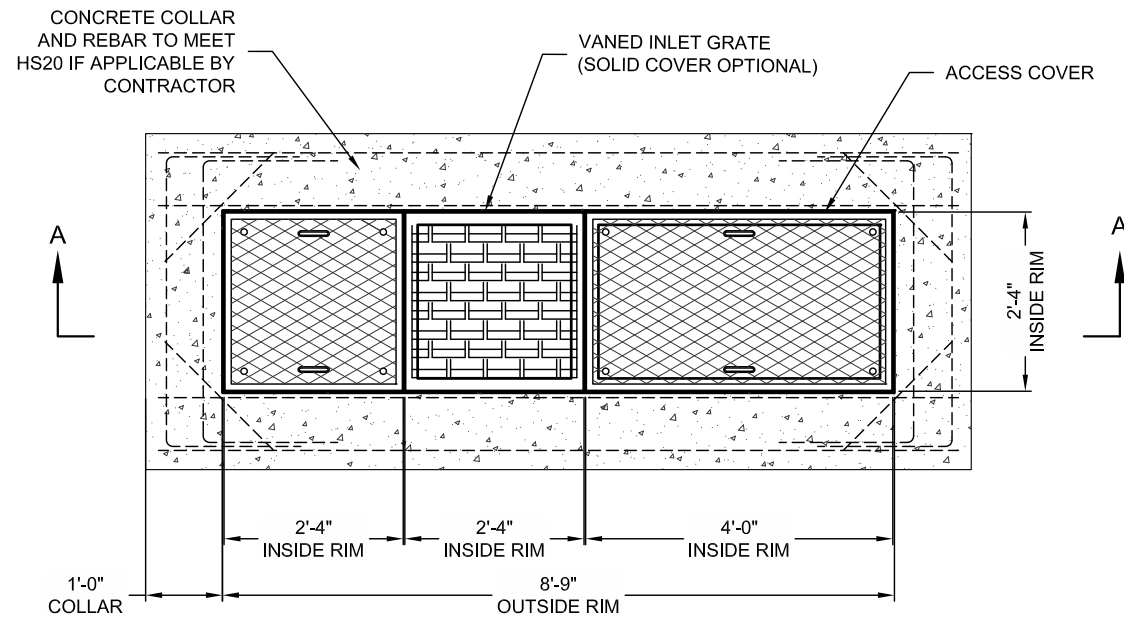

**PLAN VIEW**

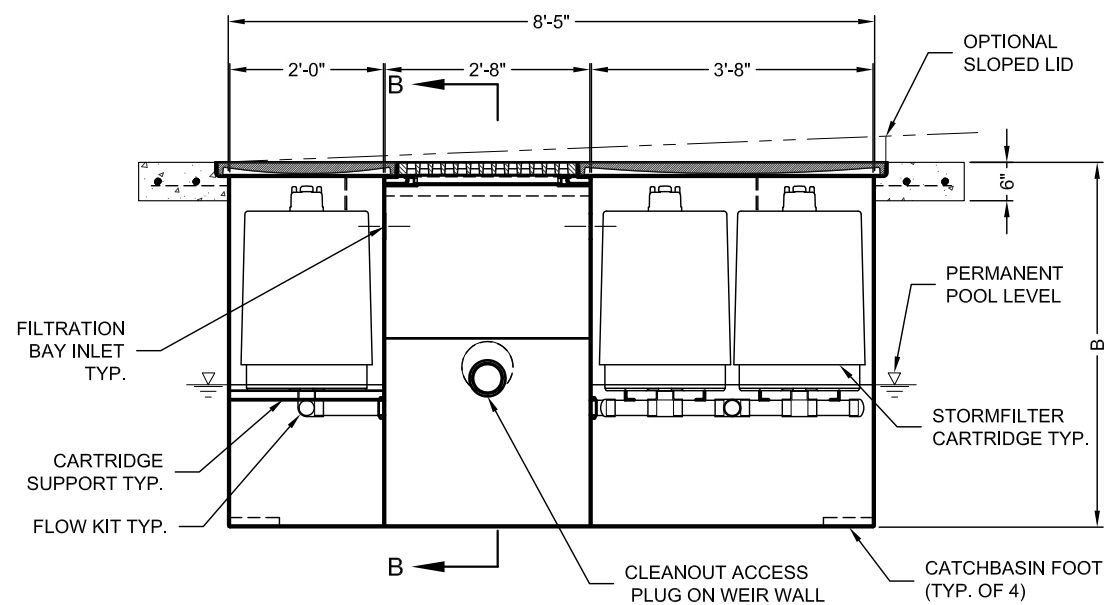

**SECTION A-A**

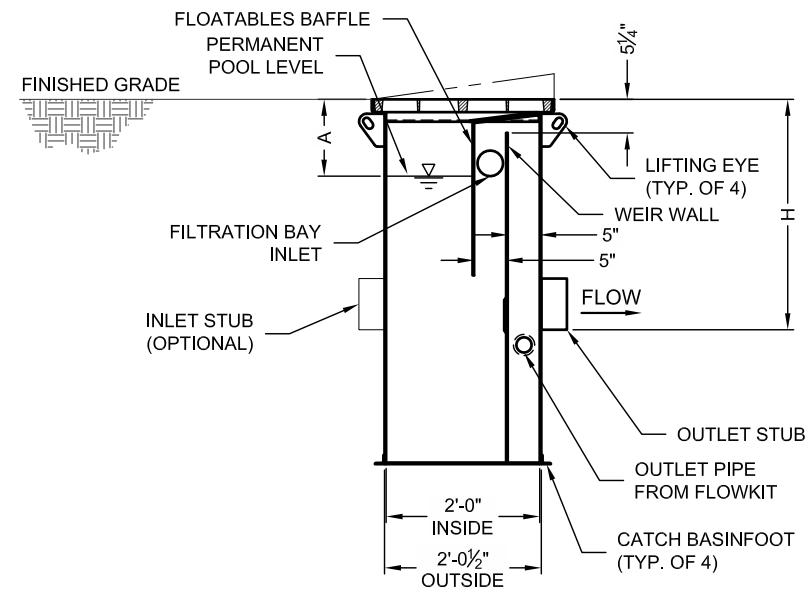

**SECTION B-B**

**STORMFILTER STEEL CATCHBASIN DESIGN NOTES**

STORMFILTER TREATMENT CAPACITY IS A FUNCTION OF THE CARTRIDGE SELECTION AND THE NUMBER OF CARTRIDGES. 3 CARTRIDGE CATCHBASIN HAS A MAXIMUM OF THREE CARTRIDGES. SYSTEM IS SHOWN WITH A 27" CARTRIDGE, AND IS ALSO AVAILABLE WITH AN 18" CARTRIDGE. STORMFILTER CATCHBASIN CONFIGURATIONS ARE AVAILABLE WITH A DRY INLET BAY FOR VECTOR CONTROL. PEAK HYDRAULIC CAPACITY PER TABLE BELOW. IF THE SITE CONDITIONS EXCEED PEAK HYDRAULIC CAPACITY, AN UPSTREAM BYPASS STRUCTURE IS REQUIRED.

**CARTRIDGE SELECTION**

CARTRIDGE HEIGHT	27"			18"			18" DEEP		
	3.05'			2.3'			3.3'		
RECOMMENDED HYDRAULIC DROP (H)	2 gpm/sf	1.67* gpm/sf	1 gpm/sf	2 gpm/sf	1.67* gpm/sf	1 gpm/sf	2 gpm/sf	1.67* gpm/sf	1 gpm/sf
SPECIFIC FLOW RATE (gpm/sf)	22.5	18.79	11.25	15	12.53	7.5	15	12.53	7.5
CARTRIDGE FLOW RATE (gpm)	1.0			1.0			1.8		
PEAK HYDRAULIC CAPACITY	1'-0"			1'-0"			2'-0"		
INLET PERMANENT POOL LEVEL (A)	4'-9"			3'-9"			4'-9"		
OVERALL STRUCTURE HEIGHT (B)									

\* 1.67 gpm/sf SPECIFIC FLOW RATE IS APPROVED WITH PHOSPHOSORB® (PSORB) MEDIA ONLY

**GENERAL NOTES**

- CONTECH TO PROVIDE ALL MATERIALS UNLESS NOTED OTHERWISE.
- FOR SITE SPECIFIC DRAWINGS WITH DETAILED STORMFILTER CATCHBASIN STRUCTURE DIMENSIONS AND WEIGHTS, PLEASE CONTACT YOUR CONTECH ENGINEERED SOLUTIONS LLC REPRESENTATIVE. [www.contechES.com](http://www.contechES.com)
- STORMFILTER CATCHBASIN WATER QUALITY STRUCTURE SHALL BE IN ACCORDANCE WITH ALL DESIGN DATA AND INFORMATION CONTAINED IN THIS DRAWING.
- INLET SHOULD NOT BE LOWER THAN OUTLET. INLET (IF APPLICABLE) AND OUTLET PIPING TO BE SPECIFIED BY ENGINEER AND PROVIDED BY CONTRACTOR.
- MANUFACTURER TO APPLY A SURFACE BEAD WELD IN THE SHAPE OF THE LETTER "O" ABOVE THE OUTLET PIPE STUB ON THE EXTERIOR SURFACE OF THE STEEL SFCB.
- STORMFILTER CATCHBASIN EQUIPPED WITH 4 INCH (APPROXIMATE) LONG STUBS FOR INLET (IF APPLICABLE) AND OUTLET PIPING. STANDARD OUTLET STUB IS 8 INCHES IN DIAMETER. MAXIMUM OUTLET STUB IS 15 INCHES IN DIAMETER. CONNECTION TO COLLECTION PIPING CAN BE MADE USING FLEXIBLE COUPLING BY CONTRACTOR.
- STEEL STRUCTURE TO BE MANUFACTURED OF 1/4 INCH STEEL PLATE. CASTINGS SHALL MEET AASHTO M306 LOAD RATING. TO MEET HS20 LOAD RATING ON STRUCTURE, A CONCRETE COLLAR IS REQUIRED. WHEN REQUIRED, CONCRETE COLLAR WITH #4 REINFORCING BARS TO BE PROVIDED BY CONTRACTOR.
- FILTER CARTRIDGES SHALL BE MEDIA-FILLED, PASSIVE, SIPHON ACTUATED, RADIAL FLOW, AND SELF CLEANING. RADIAL MEDIA DEPTH SHALL BE 7-INCHES. FILTER MEDIA CONTACT TIME SHALL BE AT LEAST 38 SECONDS.
- SPECIFIC FLOW RATE IS EQUAL TO THE FILTER TREATMENT CAPACITY (gpm) DIVIDED BY THE FILTER CONTACT SURFACE AREA (sq ft).

**INSTALLATION NOTES**

- ANY SUB-BASE, BACKFILL DEPTH, AND/OR ANTI-FLOTATION PROVISIONS ARE SITE-SPECIFIC DESIGN CONSIDERATIONS AND SHALL BE SPECIFIED BY ENGINEER OF RECORD.
- CONTRACTOR TO PROVIDE EQUIPMENT WITH SUFFICIENT LIFTING AND REACH CAPACITY TO LIFT AND SET THE CATCHBASIN (LIFTING CLUTCHES PROVIDED).
- CONTRACTOR TO TAKE APPROPRIATE MEASURES TO PROTECT CARTRIDGES FROM CONSTRUCTION-RELATED EROSION RUNOFF.

**3-CARTRIDGE CATCHBASIN STORMFILTER DATA**

STRUCTURE ID	XXX	
WATER QUALITY FLOW RATE (cfs)	X.XX	
PEAK FLOW RATE (<1 cfs)	X.XX	
RETURN PERIOD OF PEAK FLOW (yrs)	XXX	
CARTRIDGE FLOW RATE (gpm)	XX	
MEDIA TYPE (PERLITE, ZPG, PSORB)	XXXXX	
RIM ELEVATION	XXX.XX'	
PIPE DATA:	I.E.	DIAMETER
INLET STUB	XXX.XX'	XX"
OUTLET STUB	XXX.XX'	XX"
CONFIGURATION		
SLOPED LID	YES/NO	
SOLID COVER	YES/NO	
NOTES/SPECIAL REQUIREMENTS:		

I:\COMMON\ADTREATMENT\10 STORMFILTER\40 STANDARD DRAWINGS\FCB\FCB-SID\WG\FCB3-DTL.DWG 7/8/2016 2:48 PM



[www.contechES.com](http://www.contechES.com)  
 9025 Centre Pointe Dr., Suite 400, West Chester, OH 45069  
 800-526-3999 513-645-7000 513-645-7993 FAX

**3 CARTRIDGE CATCHBASIN STORMFILTER STANDARD DETAIL**

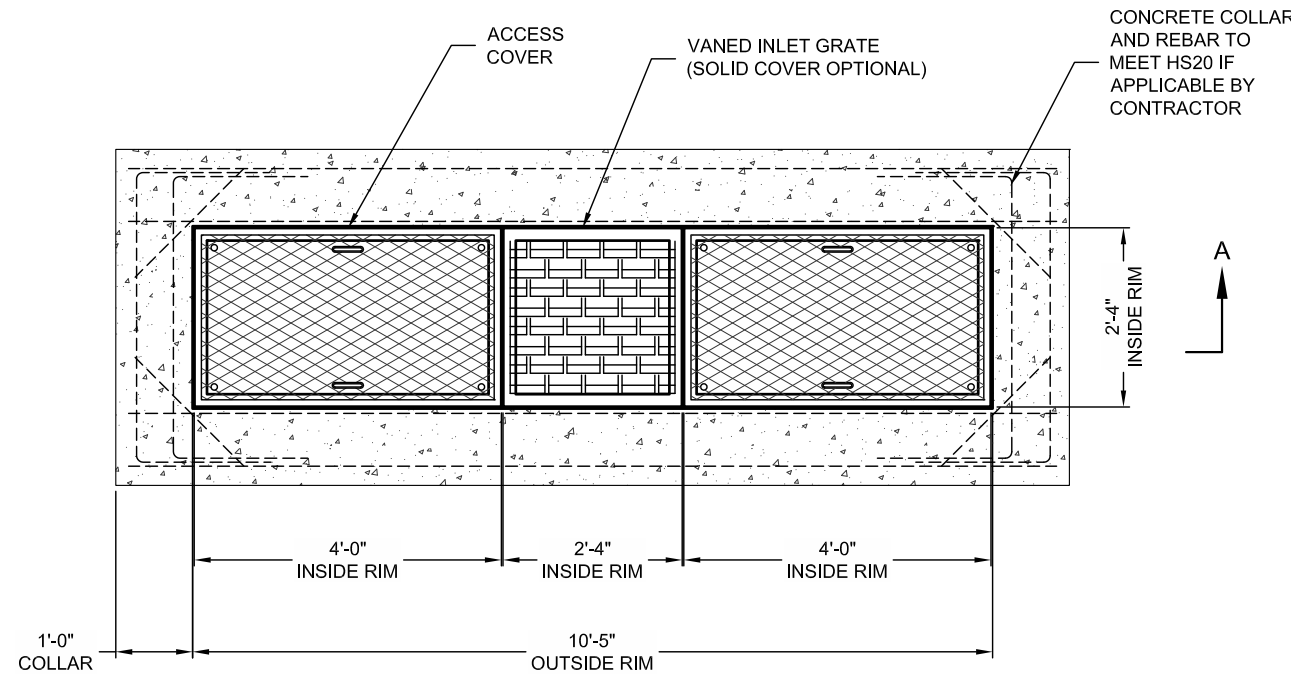

**PLAN VIEW**  
27" CARTRIDGES

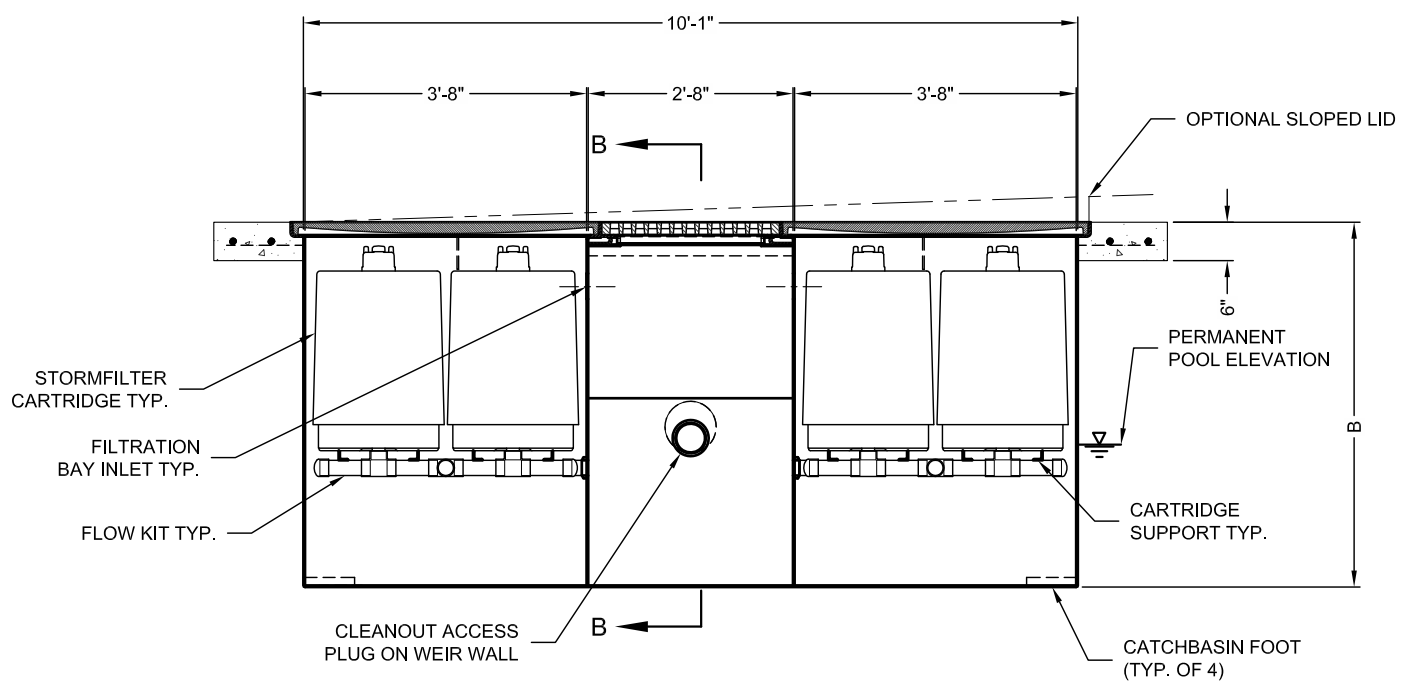

**SECTION A-A**

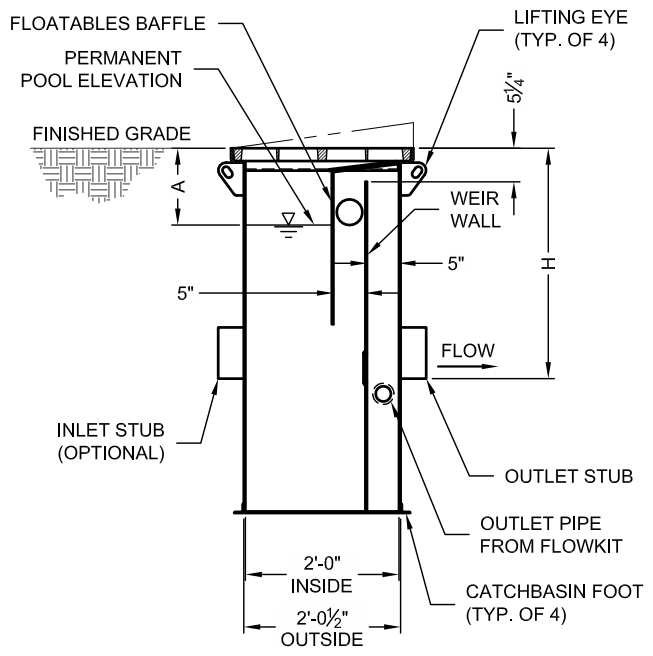

**SECTION C-C**

**STORMFILTER STEEL CATCHBASIN DESIGN NOTES**

STORMFILTER TREATMENT CAPACITY IS A FUNCTION OF THE CARTRIDGE SELECTION AND THE NUMBER OF CARTRIDGES. 4 CARTRIDGE CATCHBASIN HAS A MAXIMUM OF FOUR CARTRIDGES. SYSTEM IS SHOWN WITH A 27" CARTRIDGE, AND IS ALSO AVAILABLE WITH AN 18" CARTRIDGE. STORMFILTER CATCHBASIN CONFIGURATIONS ARE AVAILABLE WITH A DRY INLET BAY FOR VECTOR CONTROL. PEAK HYDRAULIC CAPACITY PER TABLE BELOW. IF THE SITE CONDITIONS EXCEED PEAK HYDRAULIC CAPACITY, AN UPSTREAM BYPASS STRUCTURE IS REQUIRED.

**CARTRIDGE SELECTION**

CARTRIDGE HEIGHT	27"			18"			18" DEEP		
RECOMMENDED HYDRAULIC DROP (H)	3.05'			2.3'			3.3'		
SPECIFIC FLOW RATE (gpm/sf)	2 gpm/sf	1.67* gpm/sf	1 gpm/sf	2 gpm/sf	1.67* gpm/sf	1 gpm/sf	2 gpm/sf	1.67* gpm/sf	1 gpm/sf
CARTRIDGE FLOW RATE (gpm)	22.5	18.79	11.25	15	12.53	7.5	15	12.53	7.5
PEAK HYDRAULIC CAPACITY	1.0			1.0			1.8		
INLET PERMANENT POOL LEVEL (A)	1'-0"			1'-0"			2'-0"		
OVERALL STRUCTURE HEIGHT (B)	4'-9"			3'-9"			4'-9"		

\* 1.67 gpm/sf SPECIFIC FLOW RATE IS APPROVED WITH PHOSPHOSORB® (PSORB) MEDIA ONLY

**GENERAL NOTES**

- CONTECH TO PROVIDE ALL MATERIALS UNLESS NOTED OTHERWISE.
- FOR SITE SPECIFIC DRAWINGS WITH DETAILED STORMFILTER CATCHBASIN STRUCTURE DIMENSIONS AND WEIGHTS, PLEASE CONTACT YOUR CONTECH ENGINEERED SOLUTIONS LLC REPRESENTATIVE. [www.contechES.com](http://www.contechES.com)
- STORMFILTER CATCHBASIN WATER QUALITY STRUCTURE SHALL BE IN ACCORDANCE WITH ALL DESIGN DATA AND INFORMATION CONTAINED IN THIS DRAWING.
- INLET SHOULD NOT BE LOWER THAN OUTLET. INLET (IF APPLICABLE) AND OUTLET PIPING TO BE SPECIFIED BY ENGINEER AND PROVIDED BY CONTRACTOR.
- MANUFACTURER TO APPLY A SURFACE BEAD WELD IN THE SHAPE OF THE LETTER "O" ABOVE THE OUTLET PIPE STUB ON THE EXTERIOR SURFACE OF THE STEEL SFCB.
- STORMFILTER CATCHBASIN EQUIPPED WITH 4 INCH (APPROXIMATE) LONG STUBS FOR INLET (IF APPLICABLE) AND OUTLET PIPING. STANDARD OUTLET STUB IS 8 INCHES IN DIAMETER. MAXIMUM OUTLET STUB IS 15 INCHES IN DIAMETER. CONNECTION TO COLLECTION PIPING CAN BE MADE USING FLEXIBLE COUPLING BY CONTRACTOR.
- STEEL STRUCTURE TO BE MANUFACTURED OF 1/4 INCH STEEL PLATE. CASTINGS SHALL MEET AASHTO M306 LOAD RATING. TO MEET HS20 LOAD RATING ON STRUCTURE, A CONCRETE COLLAR IS REQUIRED. WHEN REQUIRED, CONCRETE COLLAR WITH #4 REINFORCING BARS TO BE PROVIDED BY CONTRACTOR.
- FILTER CARTRIDGES SHALL BE MEDIA-FILLED, PASSIVE, SIPHON ACTUATED, RADIAL FLOW, AND SELF CLEANING. RADIAL MEDIA DEPTH SHALL BE 7-INCHES. FILTER MEDIA CONTACT TIME SHALL BE AT LEAST 38 SECONDS.
- SPECIFIC FLOW RATE IS EQUAL TO THE FILTER TREATMENT CAPACITY (gpm) DIVIDED BY THE FILTER CONTACT SURFACE AREA (sq ft).

**INSTALLATION NOTES**

- ANY SUB-BASE, BACKFILL DEPTH, AND/OR ANTI-FLOTATION PROVISIONS ARE SITE-SPECIFIC DESIGN CONSIDERATIONS AND SHALL BE SPECIFIED BY ENGINEER OF RECORD.
- CONTRACTOR TO PROVIDE EQUIPMENT WITH SUFFICIENT LIFTING AND REACH CAPACITY TO LIFT AND SET THE CATCHBASIN (LIFTING CLUTCHES PROVIDED).
- CONTRACTOR TO TAKE APPROPRIATE MEASURES TO PROTECT CARTRIDGES FROM CONSTRUCTION-RELATED EROSION RUNOFF.

**4-CARTRIDGE CATCHBASIN STORMFILTER DATA**

STRUCTURE ID	XXX
WATER QUALITY FLOW RATE (cfs)	X.XX
PEAK FLOW RATE (<1 cfs)	X.XX
RETURN PERIOD OF PEAK FLOW (yrs)	XXX
CARTRIDGE FLOW RATE (gpm)	XX
MEDIA TYPE (PERLITE, ZPG, PSORB)	XXXXX
RIM ELEVATION	XXX.XX'

PIPE DATA:	I.E.	DIAMETER
INLET STUB	XXX.XX'	XX"
OUTLET STUB	XXX.XX'	XX"

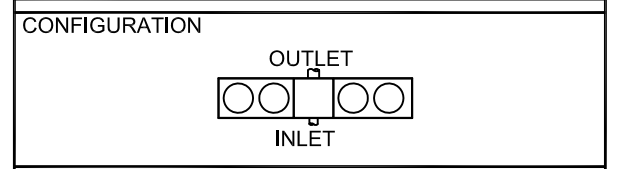

SLOPED LID	YES/NO
SOLID COVER	YES/NO
NOTES/SPECIAL REQUIREMENTS:	

\*PER ENGINEER OF RECORD

I:\COMMON\ADTREATMENT\10 STORMFILTER\10 STANDARD DRAWINGS\FCB\FCB-S\DWG\FCB-DTL.DWG 7/18/2016 2:51 PM



**CONTECH**  
ENGINEERED SOLUTIONS LLC  
[www.contechES.com](http://www.contechES.com)  
9025 Centre Pointe Dr., Suite 400, West Chester, OH 45069  
800-526-3999 513-645-7000 513-645-7993 FAX

**4 CARTRIDGE CATCHBASIN STORMFILTER STANDARD DETAIL**

## CatchBasin StormFilter™

*Important: These guidelines should be used as a part of your site stormwater plan.*

### Overview

The CatchBasin StormFilter™ (CBSF) consists of a multi-chamber steel, concrete, or plastic catch basin unit that can contain up to four StormFilter cartridges. The steel CBSF is offered both as a standard and as a deep unit.

The CBSF is installed flush with the finished grade and is applicable for both constrained lot and retrofit applications. It can also be fitted with an inlet pipe for roof leaders or similar applications.

The CBSF unit treats peak water quality design flows up to 0.13 cfs, coupled with an internal weir overflow capacity of 1.0 cfs for the standard unit, and 1.8 cfs for the deep steel and concrete units. Plastic units have an internal weir overflow capacity of 0.5 cfs.

### Design Operation

The CBSF is installed as the primary receiver of runoff, similar to a standard, grated catch basin. The steel and concrete CBSF units have an H-20 rated, traffic bearing lid that allows the filter to be installed in parking lots, and for all practical purposes, takes up no land area. Plastic units can be used in landscaped areas and for other non-traffic-bearing applications.

The CBSF consists of a sumped inlet chamber and a cartridge chamber(s). Runoff enters the sumped inlet chamber either by sheet flow from a paved surface or from an inlet pipe discharging directly to the unit vault. The inlet chamber is equipped with an internal baffle, which traps debris and floating oil and grease, and an overflow weir. While in the inlet chamber, heavier solids are allowed to settle into the deep sump, while lighter solids and soluble pollutants are directed under the baffle and into the cartridge chamber through a port between the baffle and the overflow weir.

Once in the cartridge chamber, polluted water ponds and percolates horizontally through the media in the filter cartridges. Treated water collects in the cartridge's center tube from where it is directed by an under-drain manifold to the outlet pipe on the downstream side of the overflow weir and discharged.

When flows into the CBSF exceed the water quality design value, excess water spills over the overflow weir, bypassing the cartridge bay, and discharges to the outlet pipe.

### Applications

The CBSF is particularly useful where small flows are being treated or for sites that are flat and have little available hydraulic head to spare. The unit is ideal for applications in which standard catch basins are to be used. Both water quality and catchment issues can be resolved with the use of the CBSF.

### Retro-Fit

The retrofit market has many possible applications for the CBSF. The CBSF can be installed by replacing an existing catch basin without having to "chase the grade," thus reducing the high cost of re-piping the storm system.





## CatchBasin StormFilter™

### Maintenance Guidelines

Maintenance procedures for typical catch basins can be applied to the CatchBasin StormFilter (CBSF). The filter cartridges contained in the CBSF are easily removed and replaced during maintenance activities according to the following guidelines.

1. Establish a safe working area as per typical catch basin service activity.
2. Remove steel grate and diamond plate cover (weight 100 lbs. each).
3. Turn cartridge(s) counter-clockwise to disconnect from pipe manifold.
4. Remove 4" center cap from cartridge and replace with lifting cap.
5. Remove cartridge(s) from catch basin by hand or with vactor truck boom.
6. Remove accumulated sediment via vactor truck (min. clearance 13" x 24").
7. Remove accumulated sediment from cartridge bay. (min. clearance 9.25" x 11").
8. Rinse interior of both bays and vactor remaining water and sediment.
9. Install fresh cartridge(s) threading clockwise to pipe manifold.
10. Replace cover and grate.
11. Return original cartridges to Contech for cleaning.

Media may be removed from the filter cartridges using the vactor truck before the cartridges are removed from the catch basin structure. Empty cartridges can be easily removed from the catch basin structure by hand. Empty cartridges should be reassembled and returned to Contech as appropriate.

Materials required include a lifting cap, vactor truck and fresh filter cartridges. Contact Contech for specifications and availability of the lifting cap. The vactor truck must be equipped with a hose capable of reaching areas of restricted clearance. the owner may refresh spent cartridges. Refreshed cartridges are also available from Contech on an exchange basis. Contact the maintenance department of Contech at 503-258-3157 for more information.

Maintenance is estimated at 26 minutes of site time. For units with more than one cartridge, add approximately 5 minutes for each additional cartridge. Add travel time as required.

### Mosquito Abatement

In certain areas of the United States, mosquito abatement is desirable to reduce the incidence of vectors.

In BMPs with standing water, which could provide mosquito breeding habitat, certain abatement measures can be taken.

1. Periodic observation of the standing water to determine if the facility is harboring mosquito larvae.
2. Regular catch basin maintenance.
3. Use of larvicides containing *Bacillus thuringiensis israelensis* (BTI). BTI is a bacterium toxic to mosquito and black fly larvae.

In some cases, the presence of petroleum hydrocarbons may interrupt the mosquito growth cycle.

### Using Larvicides in the CatchBasin StormFilter

Larvicides should be used according to manufacturer's recommendations.

Two widely available products are Mosquito Dunks and Summit B.t.i. Briquets. For more information, visit [http://www.summitchemical.com/mos\\_ctrl/default.htm](http://www.summitchemical.com/mos_ctrl/default.htm).

The larvicide must be in contact with the permanent pool. The larvicide should also be fastened to the CatchBasin StormFilter by string or wire to prevent displacement by high flows. A magnet can be used with a steel catch basin.

For more information on mosquito abatement in stormwater BMPs, refer to the following: <http://www.ucmrp.ucdavis.edu/publications/managingmosquitoesstormwater8125.pdf>

## StormFilter Inspection and Maintenance Procedures



## Maintenance Guidelines

The primary purpose of the Stormwater Management StormFilter® is to filter and prevent pollutants from entering our waterways. Like any effective filtration system, periodically these pollutants must be removed to restore the StormFilter to its full efficiency and effectiveness.

Maintenance requirements and frequency are dependent on the pollutant load characteristics of each site. Maintenance activities may be required in the event of a chemical spill or due to excessive sediment loading from site erosion or extreme storms. It is a good practice to inspect the system after major storm events.

## Maintenance Procedures

Although there are many effective maintenance options, we believe the following procedure to be efficient, using common equipment and existing maintenance protocols. The following two-step procedure is recommended::

### 1. Inspection

- Inspection of the vault interior to determine the need for maintenance.

### 2. Maintenance

- Cartridge replacement
- Sediment removal

## Inspection and Maintenance Timing

At least one scheduled inspection should take place per year with maintenance following as warranted.

First, an inspection should be done before the winter season. During the inspection the need for maintenance should be determined and, if disposal during maintenance will be required, samples of the accumulated sediments and media should be obtained.

Second, if warranted, a maintenance (replacement of the filter cartridges and removal of accumulated sediments) should be performed during periods of dry weather.

In addition to these two activities, it is important to check the condition of the StormFilter unit after major storms for potential damage caused by high flows and for high sediment accumulation that may be caused by localized erosion in the drainage area. It may be necessary to adjust the inspection/maintenance schedule depending on the actual operating conditions encountered by the system. In general, inspection activities can be conducted at any time, and maintenance should occur, if warranted, during dryer months in late summer to early fall.

## Maintenance Frequency

The primary factor for determining frequency of maintenance for the StormFilter is sediment loading.

A properly functioning system will remove solids from water by trapping particulates in the porous structure of the filter media inside the cartridges. The flow through the system will naturally decrease as more and more particulates are trapped. Eventually the flow through the cartridges will be low enough to require replacement. It may be possible to extend the usable span of the cartridges by removing sediment from upstream trapping devices on a routine as-needed basis, in order to prevent material from being re-suspended and discharged to the StormFilter treatment system.

The average maintenance lifecycle is approximately 1-5 years. Site conditions greatly influence maintenance requirements. StormFilter units located in areas with erosion or active construction may need to be inspected and maintained more often than those with fully stabilized surface conditions.

Regulatory requirements or a chemical spill can shift maintenance timing as well. The maintenance frequency may be adjusted as additional monitoring information becomes available during the inspection program. Areas that develop known problems should be inspected more frequently than areas that demonstrate no problems, particularly after major storms. Ultimately, inspection and maintenance activities should be scheduled based on the historic records and characteristics of an individual StormFilter system or site. It is recommended that the site owner develop a database to properly manage StormFilter inspection and maintenance programs..





## Inspection Procedures

The primary goal of an inspection is to assess the condition of the cartridges relative to the level of visual sediment loading as it relates to decreased treatment capacity. It may be desirable to conduct this inspection during a storm to observe the relative flow through the filter cartridges. If the submerged cartridges are severely plugged, then typically large amounts of sediments will be present and very little flow will be discharged from the drainage pipes. If this is the case, then maintenance is warranted and the cartridges need to be replaced.

**Warning:** In the case of a spill, the worker should abort inspection activities until the proper guidance is obtained. Notify the local hazard control agency and Contech Engineered Solutions immediately.

To conduct an inspection:

**Important:** Inspection should be performed by a person who is familiar with the operation and configuration of the StormFilter treatment unit and the unit's role, relative to detention or retention facilities onsite.

1. If applicable, set up safety equipment to protect and notify surrounding vehicle and pedestrian traffic.
2. Visually inspect the external condition of the unit and take notes concerning defects/problems.
3. Open the access portals to the vault and allow the system vent.
4. Without entering the vault, visually inspect the inside of the unit, and note accumulations of liquids and solids.
5. Be sure to record the level of sediment build-up on the floor of the vault, in the forebay, and on top of the cartridges. If flow is occurring, note the flow of water per drainage pipe. Record all observations. Digital pictures are valuable for historical documentation.
6. Close and fasten the access portals.
7. Remove safety equipment.
8. If appropriate, make notes about the local drainage area relative to ongoing construction, erosion problems, or high loading of other materials to the system.
9. Discuss conditions that suggest maintenance and make decision as to whether or not maintenance is needed.

## Maintenance Decision Tree

The need for maintenance is typically based on results of the inspection. The following Maintenance Decision Tree should be used as a general guide. (Other factors, such as Regulatory Requirements, may need to be considered).

Please note Stormwater Management StormFilter devices installed downstream of, or integrated within, a stormwater storage facility typically have different operational parameters (i.e. draindown time). In these cases, the inspector must understand the relationship between the retention/detention facility and the treatment system by evaluating site specific civil engineering plans, or contacting the engineer of record, and make adjustments to the below guidance as necessary. Sediment deposition depths and patterns within the StormFilter are likely to be quite different compared to systems without upstream storage and therefore shouldn't be used exclusively to evaluate a need for maintenance.

1. Sediment loading on the vault floor.
  - a. If  $>4$ " of accumulated sediment, maintenance is required.
2. Sediment loading on top of the cartridge.
  - a. If  $>1/4$ " of accumulation, maintenance is required.
3. Submerged cartridges.
  - a. If  $>4$ " of static water above cartridge bottom for more than 24 hours after end of rain event, maintenance is required. (Catch basins have standing water in the cartridge bay.)
4. Plugged media.
  - a. While not required in all cases, inspection of the media within the cartridge may provide valuable additional information.
  - b. If pore space between media granules is absent, maintenance is required.
5. Bypass condition.
  - a. If inspection is conducted during an average rain fall event and StormFilter remains in bypass condition (water over the internal outlet baffle wall or submerged cartridges), maintenance is required.
6. Hazardous material release.
  - a. If hazardous material release (automotive fluids or other) is reported, maintenance is required.
7. Pronounced scum line.
  - a. If pronounced scum line (say  $\geq 1/4$ " thick) is present above top cap, maintenance is required.

## Maintenance

Depending on the configuration of the particular system, maintenance personnel will be required to enter the vault to perform the maintenance.

**Important:** If vault entry is required, OSHA rules for confined space entry must be followed.

Filter cartridge replacement should occur during dry weather. It may be necessary to plug the filter inlet pipe if base flows is occurring.

Replacement cartridges can be delivered to the site or customers facility. Information concerning how to obtain the replacement cartridges is available from Contech Engineered Solutions.

**Warning:** In the case of a spill, the maintenance personnel should abort maintenance activities until the proper guidance is obtained. Notify the local hazard control agency and Contech Engineered Solutions immediately.

To conduct cartridge replacement and sediment removal maintenance:

1. If applicable, set up safety equipment to protect maintenance personnel and pedestrians from site hazards.
2. Visually inspect the external condition of the unit and take notes concerning defects/problems.
3. Open the doors (access portals) to the vault and allow the system to vent.
4. Without entering the vault, give the inside of the unit, including components, a general condition inspection.
5. Make notes about the external and internal condition of the vault. Give particular attention to recording the level of sediment build-up on the floor of the vault, in the forebay, and on top of the internal components.
6. Using appropriate equipment offload the replacement cartridges (up to 150 lbs. each) and set aside.
7. Remove used cartridges from the vault using one of the following methods:

### Method 1:

- A. This activity will require that maintenance personnel enter the vault to remove the cartridges from the under drain manifold and place them under the vault opening for lifting (removal). Disconnect each filter cartridge from the underdrain connector by rotating counterclockwise 1/4 of a turn. Roll the loose cartridge, on edge, to a convenient spot beneath the vault access.

Using appropriate hoisting equipment, attach a cable from the boom, crane, or tripod to the loose cartridge. Contact Contech Engineered Solutions for suggested attachment devices.

- B. Remove the used cartridges (up to 250 lbs. each) from the vault.



**Important:** Care must be used to avoid damaging the cartridges during removal and installation. The cost of repairing components damaged during maintenance will be the responsibility of the owner.

- C. Set the used cartridge aside or load onto the hauling truck.
- D. Continue steps a through c until all cartridges have been removed.

### Method 2:

- A. This activity will require that maintenance personnel enter the vault to remove the cartridges from the under drain manifold and place them under the vault opening for lifting (removal). Disconnect each filter cartridge from the underdrain connector by rotating counterclockwise 1/4 of a turn. Roll the loose cartridge, on edge, to a convenient spot beneath the vault access.
- B. Unscrew the cartridge cap.
- C. Remove the cartridge hood and float.
- D. At location under structure access, tip the cartridge on its side.
- E. Empty the cartridge onto the vault floor. Reassemble the empty cartridge.
- F. Set the empty, used cartridge aside or load onto the hauling truck.
- G. Continue steps a through e until all cartridges have been removed.

8. Remove accumulated sediment from the floor of the vault and from the forebay. This can most effectively be accomplished by use of a vacuum truck.
9. Once the sediments are removed, assess the condition of the vault and the condition of the connectors.
10. Using the vacuum truck boom, crane, or tripod, lower and install the new cartridges. Once again, take care not to damage connections.
11. Close and fasten the door.
12. Remove safety equipment.
13. Finally, dispose of the accumulated materials in accordance with applicable regulations. Make arrangements to return the used **empty** cartridges to Contech Engineered Solutions.

## Related Maintenance Activities - Performed on an as-needed basis

StormFilter units are often just one of many structures in a more comprehensive stormwater drainage and treatment system.

In order for maintenance of the StormFilter to be successful, it is imperative that all other components be properly maintained. The maintenance/repair of upstream facilities should be carried out prior to StormFilter maintenance activities.

In addition to considering upstream facilities, it is also important to correct any problems identified in the drainage area. Drainage area concerns may include: erosion problems, heavy oil loading, and discharges of inappropriate materials.

## Material Disposal

The accumulated sediment found in stormwater treatment and conveyance systems must be handled and disposed of in accordance with regulatory protocols. It is possible for sediments to contain measurable concentrations of heavy metals and organic chemicals (such as pesticides and petroleum products). Areas with the greatest potential for high pollutant loading include industrial areas and heavily traveled roads.

Sediments and water must be disposed of in accordance with all applicable waste disposal regulations. When scheduling maintenance, consideration must be made for the disposal of solid and liquid wastes. This typically requires coordination with a local landfill for solid waste disposal. For liquid waste disposal a number of options are available including a municipal vacuum truck decant facility, local waste water treatment plant or on-site treatment and discharge.



# Inspection Report

Date: \_\_\_\_\_ Personnel: \_\_\_\_\_

Location: \_\_\_\_\_ System Size: \_\_\_\_\_ Months in Service: \_\_\_\_\_

System Type: Vault  Cast-In-Place  Linear Catch Basin  Manhole  Other: \_\_\_\_\_

Sediment Thickness in Forebay: \_\_\_\_\_ Date: \_\_\_\_\_

Sediment Depth on Vault Floor: \_\_\_\_\_

Sediment Depth on Cartridge Top(s): \_\_\_\_\_

Structural Damage: \_\_\_\_\_

Estimated Flow from Drainage Pipes (if available): \_\_\_\_\_

Cartridges Submerged: Yes  No  Depth of Standing Water: \_\_\_\_\_

StormFilter Maintenance Activities (check off if done and give description)

Trash and Debris Removal: \_\_\_\_\_

Minor Structural Repairs: \_\_\_\_\_

Drainage Area Report \_\_\_\_\_

Excessive Oil Loading: Yes  No  Source: \_\_\_\_\_

Sediment Accumulation on Pavement: Yes  No  Source: \_\_\_\_\_

Erosion of Landscaped Areas: Yes  No  Source: \_\_\_\_\_

Items Needing Further Work: \_\_\_\_\_

Owners should contact the local public works department and inquire about how the department disposes of their street waste residuals.

Other Comments:

---

---

---

---

---

---

---

---

---

---

Review the condition reports from the previous inspection visits.

# StormFilter Maintenance Report

Date: \_\_\_\_\_ Personnel: \_\_\_\_\_

Location: \_\_\_\_\_ System Size: \_\_\_\_\_

System Type: Vault  Cast-In-Place  Linear Catch Basin  Manhole  Other: \_\_\_\_\_

List Safety Procedures and Equipment Used: \_\_\_\_\_

## System Observations

Months in Service: \_\_\_\_\_

Oil in Forebay (if present): Yes  No

Sediment Depth in Forebay (if present): \_\_\_\_\_

Sediment Depth on Vault Floor: \_\_\_\_\_

Sediment Depth on Cartridge Top(s): \_\_\_\_\_

Structural Damage: \_\_\_\_\_

## Drainage Area Report

Excessive Oil Loading: Yes  No  Source: \_\_\_\_\_

Sediment Accumulation on Pavement: Yes  No  Source: \_\_\_\_\_

Erosion of Landscaped Areas: Yes  No  Source: \_\_\_\_\_

## StormFilter Cartridge Replacement Maintenance Activities

Remove Trash and Debris: Yes  No  Details: \_\_\_\_\_

Replace Cartridges: Yes  No  Details: \_\_\_\_\_

Sediment Removed: Yes  No  Details: \_\_\_\_\_

Quantity of Sediment Removed (estimate?): \_\_\_\_\_

Minor Structural Repairs: Yes  No  Details: \_\_\_\_\_

Residuals (debris, sediment) Disposal Methods: \_\_\_\_\_

Notes:

---

---

---

---

---

---

---

---

---

---





© 2020 CONTECH ENGINEERED SOLUTIONS LLC, A QUIKRETE COMPANY

800-338-1122

[www.ContechES.com](http://www.ContechES.com)

All Rights Reserved. Printed in the USA.

Contech Engineered Solutions LLC provides site solutions for the civil engineering industry. Contech's portfolio includes bridges, drainage, sanitary sewer, stormwater and earth stabilization products. For information on other Contech division offerings, visit [www.ContechES.com](http://www.ContechES.com) or call 800.338.1122.

#### Support

- Drawings and specifications are available at [www.conteches.com](http://www.conteches.com).
- Site-specific design support is available from our engineers.

NOTHING IN THIS CATALOG SHOULD BE CONSTRUED AS A WARRANTY. APPLICATIONS SUGGESTED HEREIN ARE DESCRIBED ONLY TO HELP READERS MAKE THEIR OWN EVALUATIONS AND DECISIONS, AND ARE NEITHER GUARANTEES NOR WARRANTIES OF SUITABILITY FOR ANY APPLICATION. CONTECH MAKES NO WARRANTY WHATSOEVER, EXPRESS OR IMPLIED, RELATED TO THE APPLICATIONS, MATERIALS, COATINGS, OR PRODUCTS DISCUSSED HEREIN. ALL IMPLIED WARRANTIES OF MERCHANTABILITY AND ALL IMPLIED WARRANTIES OF FITNESS FOR ANY PARTICULAR PURPOSE ARE DISCLAIMED BY CONTECH. SEE CONTECH'S CONDITIONS OF SALE (AVAILABLE AT [WWW.CONTECHES.COM/COS](http://WWW.CONTECHES.COM/COS)) FOR MORE INFORMATION.

# APPENDIX E

GRADING AND DRAINAGE PLAN

THE LOCATIONS OF EXISTING UNDERGROUND UTILITIES ARE SHOWN IN AN APPROXIMATE WAY ONLY AND HAVE NOT BEEN INDEPENDENTLY VERIFIED BY THE CONSULTANT. THE CONSULTANT SHALL DETERMINE THE EXACT LOCATION OF ALL EXISTING UTILITIES BEFORE COMMENCING WORK AND ACCEPTS TO BE FULLY RESPONSIBLE FOR ANY AND ALL DAMAGES WHICH MIGHT BE OCCASIONED BY THE CONTRACTOR'S FAILURE TO EXACTLY LOCATE AND PRESERVE ANY AND ALL UNDERGROUND UTILITIES.

NOTICE: CONSTRUCTION SITE SAFETY IS THE SOLE RESPONSIBILITY OF THE CONTRACTOR. THE OWNER AND THE ENGINEER SHALL BE LIMITED TO THE WORK OF PROFESSIONALS IN THE WORK OF ANY NEARBY STRUCTURES, OR OF ANY OTHER PERSONS.



**GRADING & DRAINAGE PLAN**  
PRELIMINARY IMPROVEMENT PLANS  
**PARKWAY WOODS INDUSTRIAL PARK**  
WILSONVILLE, OREGON



REVISIONS:

NO.	DATE	DESCRIPTION

PM.	B BERRY
DR.	J GLUECK
JOB NO.	19004599
FILE NO.	19004599-GD05

SHEET NO.  
**05 OF 29**

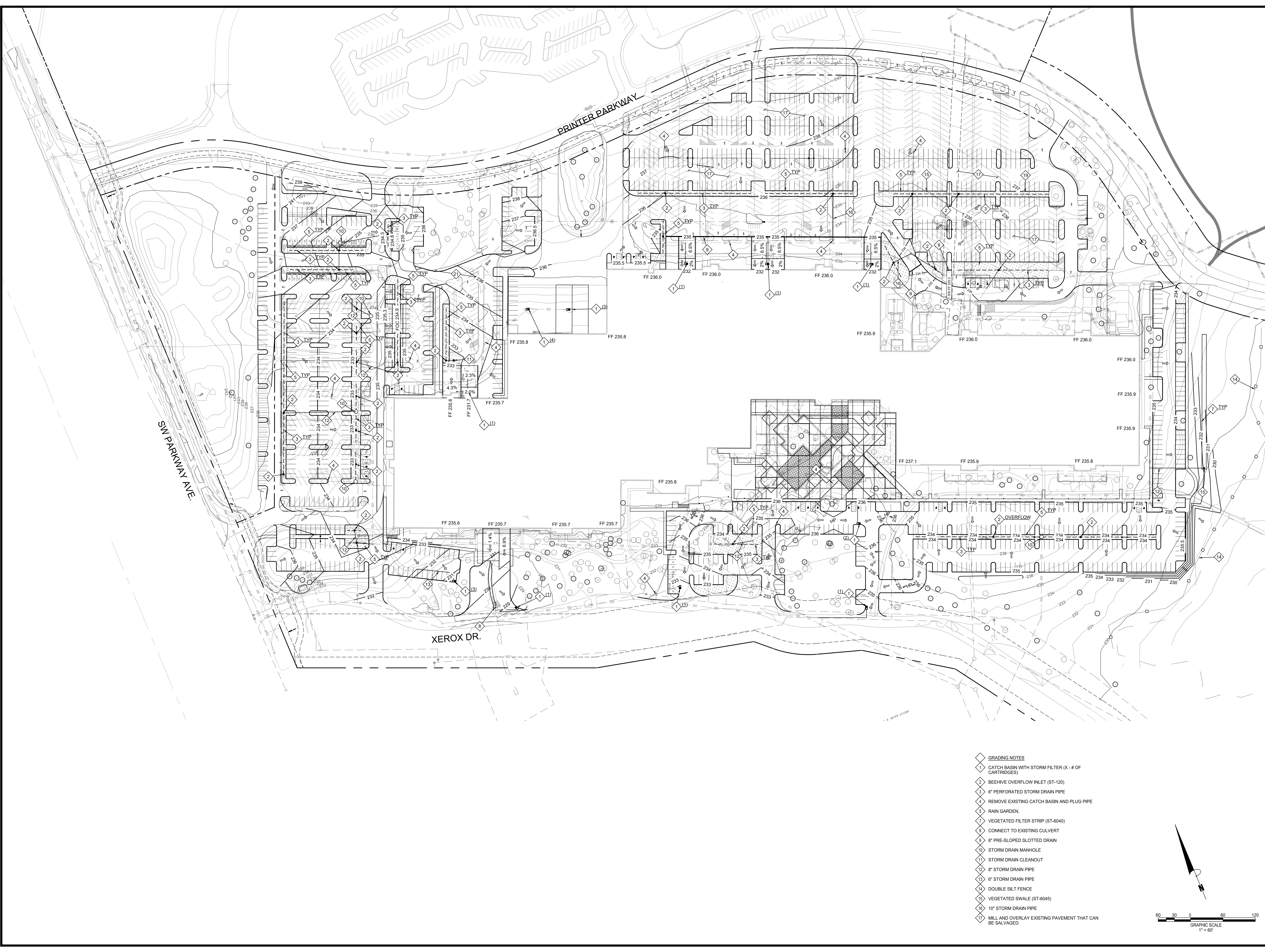

- ◇ GRADING NOTES
- 1 CATCH BASIN WITH STORM FILTER (X - # OF CARTRIDGES)
- 2 BEEHIVE OVERFLOW INLET (ST-120)
- 3 6" PERFORATED STORM DRAIN PIPE
- 4 REMOVE EXISTING CATCH BASIN AND PLUG PIPE
- 5 RAIN GARDEN
- 6 VEGETATED FILTER STRIP (ST-6040)
- 8 CONNECT TO EXISTING CULVERT
- 9 8" PRE-SLOPED SLOTTED DRAIN
- 10 STORM DRAIN MANHOLE
- 11 STORM DRAIN CLEANOUT
- 12 8" STORM DRAIN PIPE
- 13 6" STORM DRAIN PIPE
- 14 DOUBLE SILT FENCE
- 15 VEGETATED SWALE (ST-6045)
- 16 10" STORM DRAIN PIPE
- 17 MILL AND OVERLAY EXISTING PAVEMENT THAT CAN BE SALVAGED.

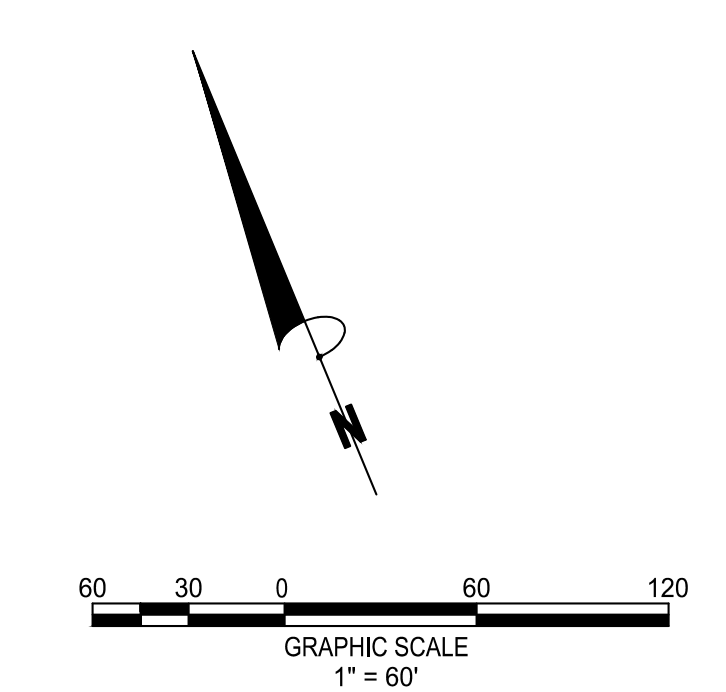

COPYRIGHT © 2020 ATWELL LLC. NO REPRODUCTION SHALL BE MADE WITHOUT THE PRIOR WRITTEN CONSENT OF ATWELL LLC.





**REQUEST FOR TRAFFIC IMPACT STUDY**

City of Wilsonville Engineering and Planning Divisions

Request Date: May 11, 2020

<input type="checkbox"/> Traffic Scope of Services	<input checked="" type="checkbox"/> Traffic Impact Study Waiver	<input type="checkbox"/> A Determination of Demeaning of Traffic	<input type="checkbox"/> Other Traffic Related Issues
--	---	--	---

<b>Applicant:</b> <input checked="" type="checkbox"/> Owner <input type="checkbox"/> Authorized Agent		<b>Site Information</b>	
Applicant: PWII Owner LLC.		Project Name: Parkway Woods Business Park Improvements	
Address: 26600 SW Parkway Avenue		Project Address: 26600 SW Parkway Avenue	
City: Wilsonville	State: OR	Zip: 97070	Tax Lot #: 511,581 & 591    Lot Size: 88.28 Acres
Email Address: mmorvai@skbcos.com			
<b>Additional Information and Fees</b>			
Is work related to a Proposed Development: Yes <input type="checkbox"/> No <input checked="" type="checkbox"/>		Land Use Case File Number:	
Is work related to a CIP: Yes <input type="checkbox"/> No <input checked="" type="checkbox"/>		CIP Number:	
Fee: Traffic Impact Study's Fee determined by the City's traffic consultant based on Scope of Services plus 15% for City overhead			

I, the applicant, certify that:

- To the best of my knowledge, all the information provided within this application package is complete and accurate.
- The above request does not violate any recorded deed restrictions that may be attached to or imposed upon the subject property.
- If the application is granted, I will exercise the rights granted in accordance with the terms and subject to all the conditions and limitations of the approval.

	Matt Morvai	5/11/2020
Applicant's or Authorized Agent's Signature	Print Name	Date
	Todd Gooding	5/11/2020
Property Owner's Signature (If not Applicant)	Print Name	Date
Address: 222 SW Columbia Street, Suite 700	City/State/Zip: Portland, OR 97201	Phone: 503.220.2600

\*Process: A Request, along with a site plan and project description must be submitted to the Engineering Division. The request is forwarded to the City's traffic consultant who will prepare a Scope of Services, which will include the necessary fee. The prepared Scope will be reviewed by the Engineering Division, and once approved, will be forwarded to the applicant/authorized agent listed above. When the applicant/authorized agent reviews and submits the fee indicated in the Scope of Services plus 15 percent for City overhead, the Scope will be authorized by Staff and forwarded to the traffic consultant. When the traffic impact study has been received and approved by the City's Engineering Division, it will be forwarded to the applicant/authorized agent and the Planning Division.

A Request for a Waiver from a Traffic Impact Study will be reviewed by the Community Director and the Engineering Division and the requestor will be notified by mail.

Note: If the project description and/or site plan change from what was originally submitted, additional traffic analysis and fees may be required.

## Kevin Apperson

---

**From:** Le, Khoi <kle@ci.wilsonville.or.us>  
**Sent:** Monday, June 29, 2020 7:07 AM  
**To:** Kevin Apperson  
**Cc:** Brady Berry  
**Subject:** RE: Traffic Impact Study Waiver

Hi Kevin,  
Thanks for the request. I have emailed Philip my support to waive the traffic impact study requirement on the proposed project.

Regards,

**Khoi Q. Le, PE**  
*Development Engineering Manager*  
City of Wilsonville

Office: 503.570.1566  
Mobile: 503.412.9646  
[kle@ci.wilsonville.or.us](mailto:kle@ci.wilsonville.or.us)  
[www.ci.wilsonville.or.us](http://www.ci.wilsonville.or.us)  
[Facebook.com/CityofWilsonville](https://www.facebook.com/CityofWilsonville)



29799 SW Town Center Loop East, Wilsonville, OR 97070

*Disclosure Notice: Messages to and from this e-mail address may be subject to the Oregon Public Records Law.*

*City Hall is now open, with physical distancing controls in place. During COVID-19, we wish to remain responsive while prioritizing the health and safety of the Wilsonville community. We are happy to meet by call or teleconference as an alternative to face-to-face meetings.*

---

**From:** Kevin Apperson <kapperson@atwell-group.com>  
**Sent:** Friday, June 26, 2020 7:39 AM  
**To:** Le, Khoi <kle@ci.wilsonville.or.us>  
**Cc:** Brady Berry <bberry@atwell-group.com>  
**Subject:** Traffic Impact Study Waiver

**[This email originated outside of the City of Wilsonville]**

---

Good Morning Koi,

Attached is a copy of a Traffic Impact Study waiver request and site plan illustrating the proposed improvements associated with the Parkway Woods Business Park. Improvements are limited to reconfiguration of the

parking/circulation areas; the addition of an outdoor plaza on the south side of the building; and some minor functional improvements to the building (addition of entry doors, roll up doors and windows). No expansion of the building or additional square footage is proposed.

It is our understanding talking with Philip Bradford that the City requires a written approval of the waiver as part of our land use submittal.

If you have any questions, please let me know.

Regards,

**Kevin Apperson**

Planner/Landscape Architect

**ATWELL, LLC**

971.334.8964 Tel

9755 SW Barnes Road | Suite 150 | Portland, OR 97225

[www.atwell-group.com](http://www.atwell-group.com)

Confidential Notice: This is a confidential communication. If you received in error, please notify the sender of the delivery error by replying to this message and then delete it from your system. Electronic Data: Since data stored on electronic media can deteriorate, be translated or modified, Atwell, LLC will not be liable for the completeness, correctness or readability of the electronic data. The electronic data should be checked against the hard copy (paper, mylar, etc.). Hard copies are on file with Atwell and can be provided upon request.

**External Email: Do not click any links or open any attachments unless you trust the sender and know the content is safe.**

## Kevin Apperson

---

**From:** Kevin Apperson  
**Sent:** Friday, May 1, 2020 11:54 AM  
**To:** Jason Arn (Jason.arn@tvfr.com)  
**Subject:** TVFR Land Use Review  
**Attachments:** TVFR Land Use Review Application.pdf; FS-1\_Aerial Fire Truck Access Exhibit.pdf; FS-2 \_ Parkway Woods Building Improvements Exhibit.pdf; FS-3\_Existing Conditions.pdf

Good morning Jason,

We are working on a project in the City of Wilsonville at the old Xerox facility, known as the Parkway Wood Business Park. The Owner/Applicant is proposing some minor improvements to the building (i.e. new window and doors) as well as some major changes to the circulation and surface parking (includes expansion and refiguration). The end result would be allow access and parking to all sides of the existing building. I have attached a copy of the proposed plan (FS-1) as well as the existing conditions plan (FS-3) so you can see the changes to the circulation and parking configurations. I've also included a plan that illustrates the proposed building modifications (FS-2).

Please let me know if you have any questions.

Thank you,

### Kevin Apperson

Planner/Landscape Architect

**ATWELL, LLC**

971.334.8964 Tel 503.757.9626 (c)

9755 SW Barnes Road | Suite 150 | Portland, OR 97225

[www.atwell-group.com](http://www.atwell-group.com)



**FIRE CODE / LAND USE / BUILDING REVIEW  
APPLICATION**



**North Operating Center**  
11945 SW 70<sup>th</sup> Avenue  
Tigard, OR 97223  
Phone: 503-649-8577

**South Operating Center**  
8445 SW Elligsen Rd  
Wilsonville, OR 97070  
Phone: 503-259-1500

REV 12-12-2019

**Project Information**

Applicant Name: \_\_\_\_\_  
Address: \_\_\_\_\_  
Phone: \_\_\_\_\_  
Email: \_\_\_\_\_  
Site Address: \_\_\_\_\_  
City: \_\_\_\_\_  
Map & Tax Lot #: \_\_\_\_\_  
Business Name: \_\_\_\_\_  
Land Use/Building Jurisdiction: \_\_\_\_\_  
Land Use/ Building Permit # \_\_\_\_\_

Choose from: Beaverton, Tigard, Newberg, Tualatin, North Plains, West Linn, Wilsonville, Sherwood, Rivergrove, Durham, King City, Washington County, Clackamas County, Multnomah County, Yamhill County

**Project Description**

**Permit/Review Type (check one):**

- Land Use / Building Review - Service Provider Permit
- Emergency Radio Responder Coverage Install/Test
- LPG Tank (Greater than 2,000 gallons)
- Flammable or Combustible Liquid Tank Installation (Greater than 1,000 gallons)
- Explosives Blasting (Blasting plan is required)
- Exterior Toxic, Pyrophoric or Corrosive Gas Installation (in excess of 810 cu.ft.)
- Tents or Temporary Membrane Structures (in excess of 10,000 square feet)
- Temporary Haunted House or similar
- OLCC Cannabis Extraction License Review
- Ceremonial Fire or Bonfire (For gathering, ceremony or other assembly)

**For Fire Marshal's Office Use Only**

TVFR Permit # \_\_\_\_\_  
Permit Type: \_\_\_\_\_  
Submittal Date: \_\_\_\_\_  
Assigned To: \_\_\_\_\_  
Due Date: \_\_\_\_\_  
Fees Due: \_\_\_\_\_  
Fees Paid: \_\_\_\_\_

**Approval/Inspection Conditions**

(For Fire Marshal's Office Use Only)

**This section is for application approval only**

Fire Marshal or Designee \_\_\_\_\_ Date \_\_\_\_\_

Conditions:

**See Attached Conditions:**    Yes    No

**Site Inspection Required:**    Yes    No

**This section used when site inspection is required**

Inspection Comments:

\_\_\_\_\_  
Final TVFR Approval Signature & Emp ID                      Date



www.tvfr.com

Command & Business Operations Center  
and North Operating Center  
11945 SW 70<sup>th</sup> Avenue  
Tigard, Oregon 97223-8566  
503-649-8577

South Operating Center  
8445 SW Elligsen Road  
Wilsonville, Oregon  
97070-9641  
503-649-8577

Training Center  
12400 SW Tonquin Road  
Sherwood, Oregon  
97140-9734  
503-259-1600

## FIRE DEPARTMENT ACCESS AND WATER SUPPLY PERMIT CHECKLIST

<b>Project Name</b>	<b>Address and/or Legal Description</b>	<b>TVF&amp;R Permit #</b>
Description of Proposed Work:		Jurisdiction: <b>Wilsonville</b>
Bldg. Square Footage:	Type of Construction: <b>No new buildings</b>	Fire Sprinklers: Y <input type="checkbox"/> N <input type="checkbox"/>
Fire Alarms: Y <input type="checkbox"/> N <input type="checkbox"/>	Bldg. Height: (Measured to gutter line or top of parapet) <b>Buildings are existing - Building height unknown</b>	ERRC <input type="checkbox"/> MERRC <input type="checkbox"/> N/A <input type="checkbox"/>

**Complete checklist below if the submittal involves constructing or altering a building.**

ITEM #	PROVIDED		REQUIREMENT	CODE REF
1	Y	N/A	Fire service plans shall consist of a site plan and elevation views of buildings. The site plan shall be labeled as FS-1. Elevation view sheets shall be FS-2, FS-3, etc.	OFC 105.4.2
2	Y	N/A	Access roads shall be within 150 feet of all portions of the exterior wall of the first story of the building as measured by an approved route around the exterior of the building or facility. An approved turnaround is required if the remaining distance to an approved intersecting roadway, as measured along the fire apparatus access road, is greater than 150 feet. (OFC 503.1.1)	OFC 503.1.1
3	Y	N/A	Dead end fire apparatus access roads in excess of 150 feet in length shall be provided with an approved turnaround. Diagrams can be found in the corresponding guide located at: <a href="http://www.tvfr.com/DocumentCenter/View/1296">http://www.tvfr.com/DocumentCenter/View/1296</a> .	OFC 503.2.5 & D103.1
4	Y	N/A	Buildings exceeding 30 feet in height or three stories in height shall have at least two separate means of fire apparatus access.	D104.1
5	Y	N/A	Buildings or facilities having a gross building area of more than 62,000 square feet shall have at least two approved separate means of fire apparatus access. Exception: Projects having a gross building area of up to 124,000 square feet that have a single approved fire apparatus access road when all buildings are equipped throughout with approved automatic sprinkler systems.	OFC D104.2
6	Y	N/A	Multifamily projects having more than 100 dwelling units shall be provided with two separate and approved fire apparatus access roads. Exception: Projects having up to 200 dwelling units may have a single approved fire apparatus access road when all buildings, including nonresidential occupancies, are equipped throughout with an approved automatic sprinkler system in accordance with section 903.3.1.1, 903.3.1.2. Projects having more than 200 dwelling units shall be provided with two separate and approved fire apparatus roads regardless of whether they are equipped with an approved automatic sprinkler system.	OFC D106
7	Y	N/A	Buildings with a vertical distance between the grade plane and the highest roof surface that exceeds 30 feet in height shall be provided with a fire apparatus access road constructed for use by aerial apparatus with an unobstructed driving surface width of not less than 26 feet. For the purposes of this section, the highest roof surface shall be determined by	OFC D105.1, D105.2

ITEM #	PROVIDED		REQUIREMENT	CODE REF
			measurement to the eave of a pitched roof, the intersection of the roof to the exterior wall, or the top of the parapet walls, whichever is greater. Any portion of the building may be used for this measurement, provided that it is accessible to firefighters and is capable of supporting ground ladder placement.	
8	Y	N/A	Developments of one- or two-family dwellings, where the number of dwelling units exceeds 30, shall be provided with separate and approved fire apparatus access roads and shall meet the requirements of Section D104.3. Exception: Where there are more than 30 dwelling units on a single public or private fire apparatus access road and all dwelling units are equipped throughout with an approved automatic sprinkler system in accordance with section 903.3.1.1, 903.3.1.2, or 903.3.1.3 of the International Fire Code, access from two directions shall not be required.	OFC D107
9	Y	N/A	At least one of the required aerial access routes shall be located within a minimum of 15 feet and a maximum of 30 feet from the building, and shall be positioned parallel to one entire side of the building. The side of the building on which the aerial access road is positioned shall be approved by the Fire Marshal. Overhead utility and power lines shall not be located over the aerial access road or between the aerial access road and the building.	OFC D105.3, D105.4
10	Y	N/A	Where two access roads are required, they shall be placed a distance apart equal to not less than one half of the length of the maximum overall diagonal dimension of the area to be served (as identified by the Fire Marshal), measured in a straight line between accesses.	OFC D104.3
11	Y	N/A	Fire apparatus access roads shall have an unobstructed driving surface width of not less than 20 feet (26 feet adjacent to fire hydrants and an unobstructed vertical clearance of not less than 13 feet 6 inches).	OFC 503.2.1 & D103.1
12	Y	N/A	The fire district will approve access roads of 12 feet for up to three dwelling units (Group R-3) and accessory (Group U) buildings.	OFC 503.1.1
13	Y	N/A	Where access roads are less than 20 feet and exceed 400 feet in length, turnouts 10 feet wide and 30 feet long may be required and will be determined on a case by case basis.	OFC 503.2.2
14	Y	N/A	Where fire apparatus roadways are not of sufficient width to accommodate parked vehicles and 20 feet of unobstructed driving surface, "No Parking" signs shall be installed on one or both sides of the roadway and in turnarounds as needed. Signs shall read "NO PARKING - FIRE LANE" and shall be installed with a clear space above grade level of 7 feet. Signs shall be 12 inches wide by 18 inches high and shall have red letters on a white reflective background.	OFC D103.6
15	Y	N/A	Where required, fire apparatus access roadway curbs shall be painted red (or as approved) and marked "NO PARKING FIRE LANE" at 25-foot intervals. Lettering shall have a stroke of not less than one inch wide by six inches high. Lettering shall be white on red background	OFC 503.3
16	Y	N/A	Where a fire hydrant is located on a fire apparatus access road, the minimum road width shall be 26 feet and shall extend 20 feet before and after the point of the hydrant.	OFC D103.1
17	Y	N/A	Where access roads are less than 20 feet and exceed 400 feet in length, turnouts 10 feet wide and 30 feet long may be required and will be determined on a case by case basis.	OFC 503.2.2
18	Y	N/A	Fire apparatus access roads shall be of an all-weather surface that is easily distinguishable from the surrounding area and is capable of supporting not less than 12,500 pounds point load (wheel load) and 75,000 pounds live load (gross vehicle weight). Documentation from a registered engineer that the final construction is in accordance with approved plans or the requirements of the Fire Code may be requested.	OFC 503.2.3
19	Y	N/A	The inside turning radius and outside turning radius shall not be less than 28 feet and 48 feet respectively, measured from the same center point.	OFC 503.2.4 & D103.3
20	Y	N/A	Fire apparatus access roadway grades shall not exceed 15%. Alternate methods and materials may be available at the discretion of the Fire Marshal (for grade exceeding 15%).	OFC D103.2
21	Y	N/A	Approved forest dwellings (in which the structure meets all County forest dwelling fire siting, fire retardant roof, and spark arrestor requirements) are allowed up to 20% maximum grade. Access roads greater than 20% shall be considered on a case-by-case basis. Forest dwelling access roads shall be an all-weather surface capable of supporting imposed loads of not less than 37,000 pounds gross vehicle weight and be no less than 12 feet minimum width. All other access requirements, including turnarounds shall be determined upon a heavy brush unit response capability to the individual property.	OFC 503.1.1 & D102.1.1

ITEM #	PROVIDED		REQUIREMENT	CODE REF
	Y	N/A		
22	Y	N/A	Turnarounds shall be as flat as possible and have a maximum of 5% grade with the exception of crowning for water run-off.	OFC 503.2.7 & D103.2
23	Y	N/A	Intersections shall be level (maximum 5%) with the exception of crowning for water run-off.	OFC 503.2.7 & D103.2
24	Y	N/A	Portions of aerial apparatus roads that will be used for aerial operations shall be as flat as possible. Front to rear and side to side maximum slope shall not exceed 10%.	OFC D103.2
25	Y	N/A	Gates securing fire apparatus roads shall comply with all of the following: <ol style="list-style-type: none"> <li>1. Minimum unobstructed width shall be not less than 20 feet (or the required roadway surface width).</li> <li>2. Gates shall be set back at minimum of 30 feet from the intersecting roadway or as approved.</li> <li>3. Electric gates shall be equipped with a means for operation by fire department personnel.</li> <li>4. Electric automatic gates shall comply with ASTM F 2200 and UL 325.</li> </ol>	OFC D103.5, & 503.6
26	Y	N/A	Private bridges shall be designed and constructed in accordance with the State of Oregon Department of Transportation and American Association of State Highway and Transportation Officials Standards <i>Standard Specification for Highway Bridges</i> . Vehicle load limits shall be posted at both entrances to bridges when required by the Fire Marshal.	OFC 503.2.6
27	Y	N/A	Applicants shall provide documentation of a fire hydrant flow test or flow test modeling of water availability from the local water purveyor if the project includes a new structure or increase in the floor area of an existing structure. Tests shall be conducted from a fire hydrant within 400 feet for commercial projects, or 600 feet for residential development. Flow tests will be accepted if they were performed within 5 years as long as no adverse modifications have been made to the supply system. Water availability information may not be required to be submitted for every project.	OFC Appendix B
28	Y	N/A	Where a portion of a commercial building is more than 400 feet from a hydrant on a fire apparatus access road, as measured in an approved route around the exterior of the building, on-site fire hydrants and mains shall be provided.	OFC 507.5.1
29	Y	N/A	Where the most remote portion of a residential structure is more than 600 feet from a hydrant on a fire apparatus access road, as measured in an approved route around the exterior of the structure(s), on-site fire hydrants and mains shall be provided.	OFC 507.5.1
30	Y	N/A	Rural one-and-two-family dwellings, where there is no fixed and reliable water supply and there is approved access, shall not be required to provide a firefighting water supply.	OFC B103
31	Y	N/A	Detached U occupancies, in rural areas, that are in excess of 3,600 square feet are not required to have a water supply when they have approved fire department access.	OFC D102
32	Y	N/A	Fire hydrants shall be located not more than 15 feet from an approved fire apparatus access roadway unless approved by the Fire Marshal.	OFC C102.1
33	Y	N/A	Where fire hydrants are subject to impact by a motor vehicle, guard posts, bollards or other approved means of protection shall be provided.	OFC 507.5.6 & OFC 312
34	Y	N/A	FDCs shall be located within 100 feet of a fire hydrant (or as approved). Hydrants and FDC's shall be located on the same side of the fire apparatus access roadway or drive aisle, fully visible, and recognizable from the street or nearest point of the fire department vehicle access or as otherwise approved.	OFC 912.2.1 & NFPA 13

ITEM #	PROVIDED		REQUIREMENT	CODE REF
35	Y	N/A	<p>In new buildings where the design reduces the level of radio coverage for public safety communications systems below minimum performance levels, a distributed antenna system, signal booster, or other method approved by TVF&amp;R and Washington County Consolidated Communications Agency shall be provided.</p> <p><a href="http://www.tvfr.com/DocumentCenter/View/1296">http://www.tvfr.com/DocumentCenter/View/1296</a>.</p> <ul style="list-style-type: none"> <li>• Emergency responder radio system testing and/or system installation is required for this building. Please contact me (using my contact info below) for further information including an alternate means of compliance that is available. If the alternate method is preferred, it must be requested from TVF&amp;R prior to issuance of building permit.</li> <li>• Testing shall take place after the installation of all roofing systems; exterior walls, glazing and siding/cladding; and all permanent interior walls, partitions, ceilings, and glazing.</li> </ul> <p>MERRC Q&amp;A <a href="#">MERRC Q&amp;A</a>  MERRC Permit Application <a href="#">MERRC Permit Application</a></p>	OFC 510, Appendix F, & OSSC 915
36	Y	N/A	<p>A Knox box for building access may be required for structures and gates. See Appendix B for further information and detail on required installations. Order via <a href="http://www.knoxbox.com">www.knoxbox.com</a> or contact TVF&amp;R for assistance and instructions regarding installation and placement.</p>	OFC 506.1

COPYRIGHT © 2020 ATWELL LLC. NO REPRODUCTION SHALL BE MADE WITHOUT THE PRIOR WRITTEN CONSENT OF ATWELL LLC.

K:\19004599 - parkway wood industrial park\utility\exhibits\2020-04-13 vehicle tracking\vehicle tracking.dwg Plotdate: 7/2/2020

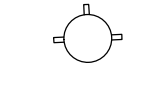
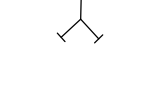
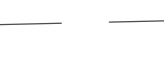

### TVFR AERIAL FIRE TRUCK VEHICLE TRACKING

- LEGEND**
-  FIRE HYDRANT
  -  FIRE DEPARTMENT CONNECTION
  -  WATER UTILITY LINES

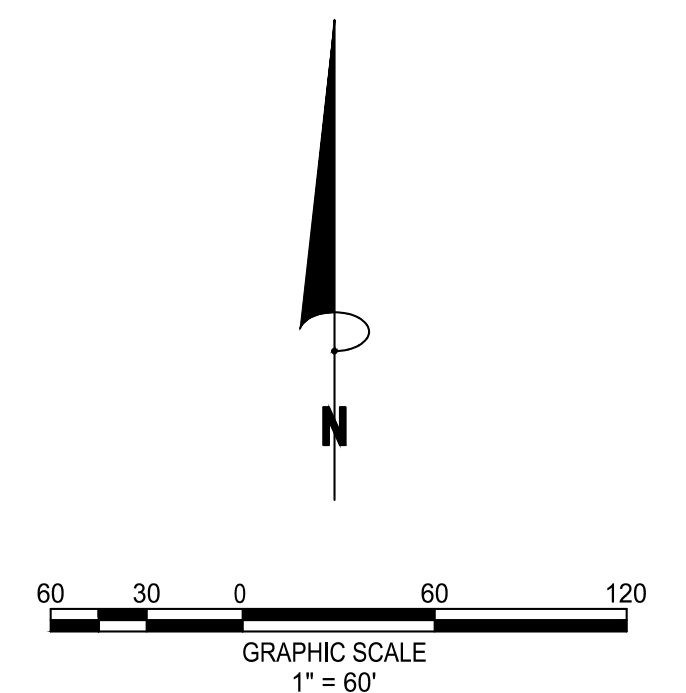

THE LOCATIONS OF EXISTING UNDERGROUND UTILITIES ARE SHOWN IN AN APPROXIMATE WAY ONLY AND HAVE NOT BEEN INDEPENDENTLY VERIFIED BY THE OWNER OR ITS ENGINEER. THE CONTRACTOR SHALL DETERMINE THE EXACT LOCATION OF ALL EXISTING UTILITIES BEFORE COMMENCING WORK, AND AGREE TO BE FULLY RESPONSIBLE FOR ANY AND ALL DAMAGES WHICH MIGHT BE OCCURRED BY THE CONTRACTOR'S FAILURE TO EXACTLY LOCATE AND PRESERVE ANY AND ALL UNDERGROUND UTILITIES.

**NOTICE:** CONSTRUCTION SITE SAFETY IS THE SOLE RESPONSIBILITY OF THE OWNER. THE ENGINEER SHALL BE EXPECTED TO ASSUME ANY RESPONSIBILITY FOR SAFETY OF THE WORK OF PERSONS ENGAGED IN THE WORK OF ANY NEARBY STRUCTURES, OR ANY OTHER PERSONS.



TVFR AERIAL FIRE TRUCK VEHICLE TRACKING EXHIBIT  
 PARKWAY WOODS INDUSTRIAL PARK  
 WILSONVILLE, OR



REVISIONS:

PM.	BB
DR.	JG
JOB NO. 19004599	
FILE NO. Vehicle Tracking	

SHEET NO.  
**FS-1**

Owner:  
**Scanlan  
Kemper  
Bard**

26600 SW Parkway Ave  
Wilsonville, Oregon 97070

Project:  
**Parkway Woods  
Improvement**

Wilsonville, Oregon 97070

Sheet Title:  
**Proposed Plan**

Revisions:

MILDREN DESIGN GROUP, P.C., 2019. ALL RIGHTS RESERVED ©  
THESE DRAWINGS ARE THE PROPERTY OF MILDREN DESIGN GROUP, P.C., AND ARE NOT TO BE USED OR REPRODUCED IN ANY MANNER EXCEPT WITH THE PRIOR WRITTEN PERMISSION OF MILDREN DESIGN GROUP, P.C.

Date:  
Drawn by: \_\_\_\_\_ Checked by: TQL

Job Number: 118161

Sheet  
**FS-2**

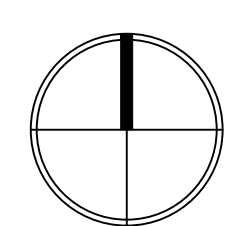
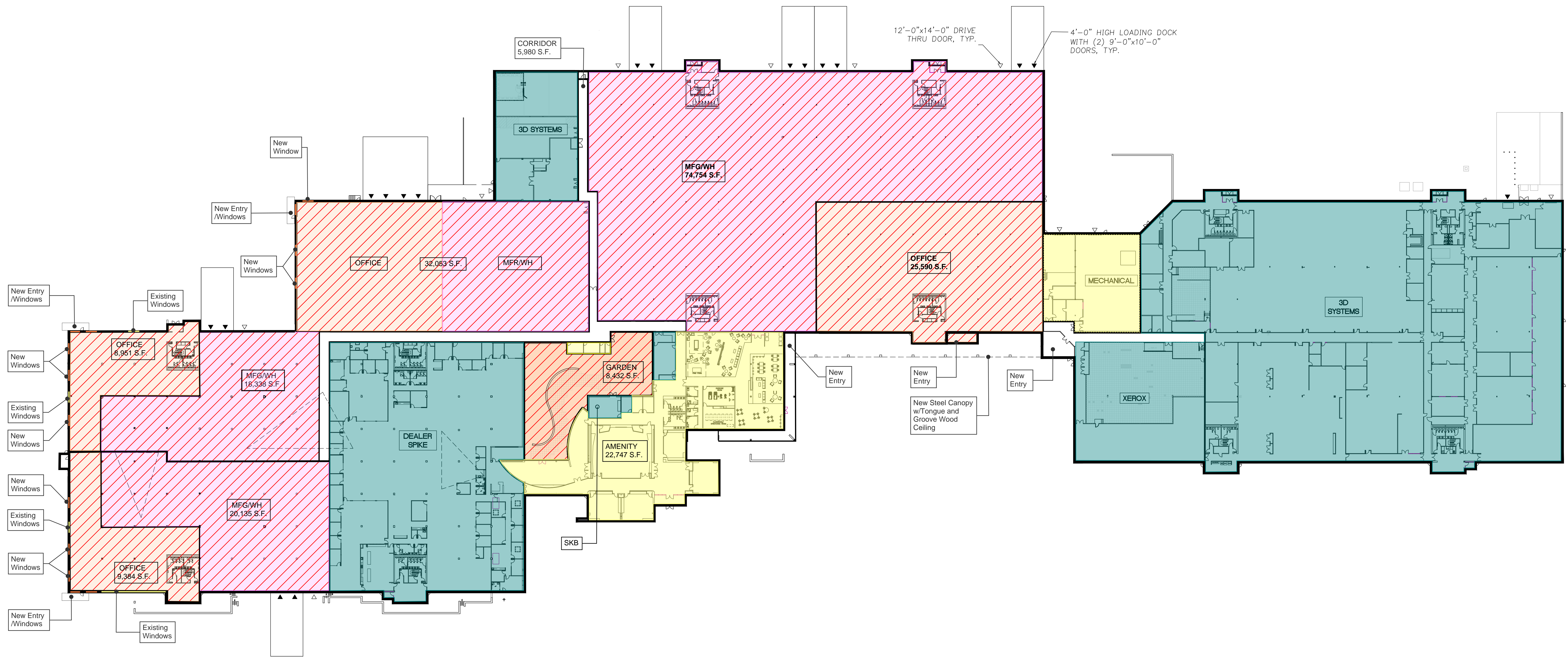

**Proposed Plan**

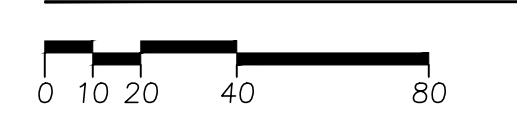

COPYRIGHT © 2020 ATWELL LLC NO REPRODUCTION SHALL BE MADE WITHOUT THE PRIOR WRITTEN CONSENT OF ATWELL LLC

K:\19004599 - parkway wood industrial park\topog\plan sheets\preliminary\19004599-402.dwg PlotDate: 4/15/2020

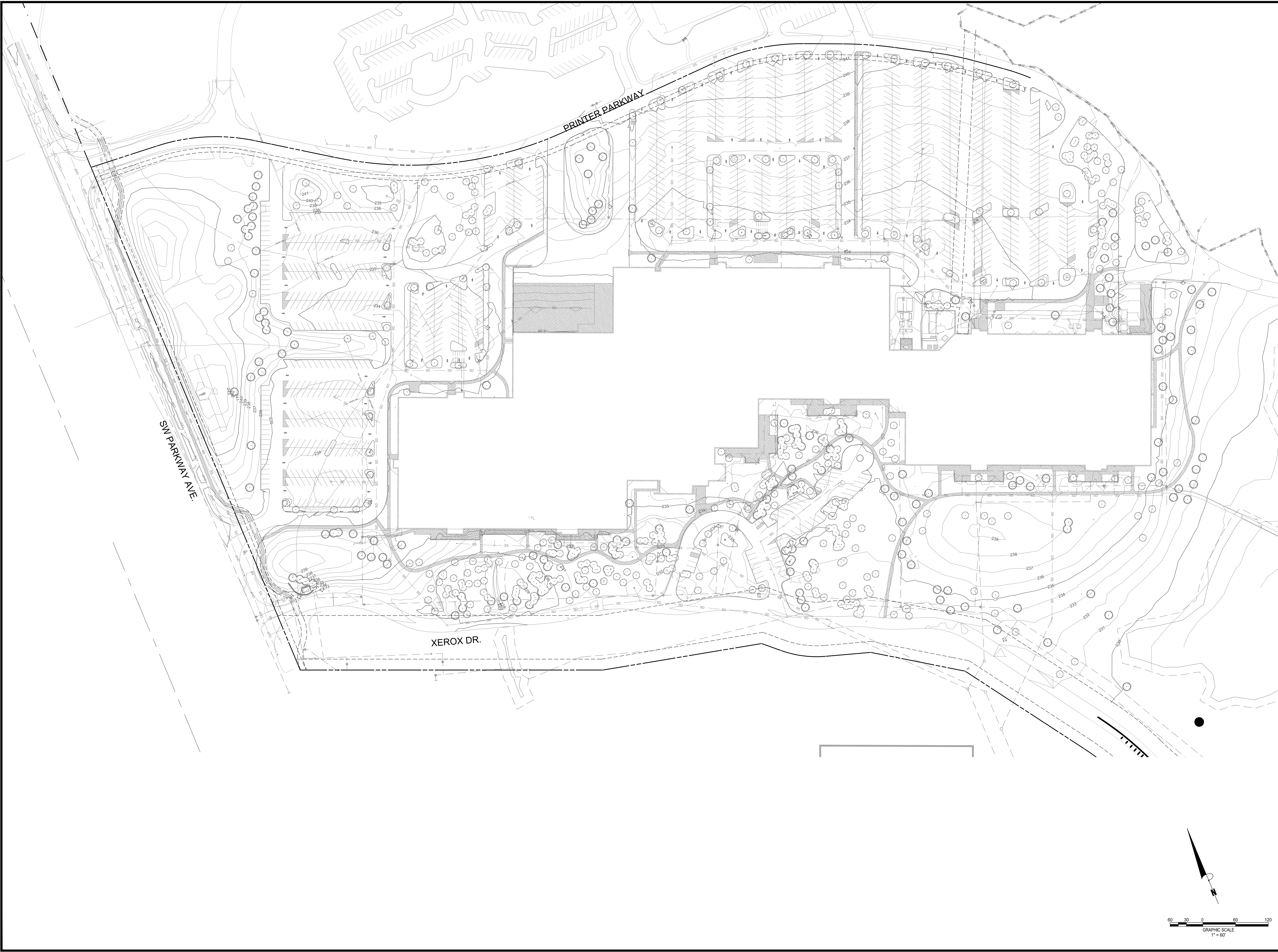

THE LOCATIONS OF EXISTING UNDERGROUND UTILITIES ARE SHOWN IN AN APPROXIMATE WAY ONLY AND HAVE NOT BEEN INDEPENDENTLY VERIFIED BY THE OWNER OR ITS ENGINEER. THE CONTRACTOR SHALL DETERMINE THE EXACT LOCATION OF ALL EXISTING UTILITIES BEFORE COMMENCING WORK, AND ACCEPTS TO BE FULLY RESPONSIBLE FOR ANY AND ALL DAMAGES WHICH MIGHT BE OCCASIONED BY THE CONTRACTOR'S FAILURE TO EXACTLY LOCATE AND PRESERVE ANY AND ALL UNDERGROUND UTILITIES.

NOTICE: CONSTRUCTION SITE SAFETY IS THE SOLE RESPONSIBILITY OF THE CONTRACTOR. NEITHER THE OWNER NOR THE ENGINEER SHALL BE RESPONSIBLE FOR SAFETY OF THE WORK OF PERSONS ENGAGED IN THE WORK OF ANY NEARBY STRUCTURES, OR OF ANY OTHER PERSONS.



**TOPOGRAPHIC SURVEY-EXISTING CONDITIONS**  
 PRELIMINARY IMPROVEMENT PLANS  
**PARKWAY WOOD INDUSTRIAL PARK**  
 WILSONVILLE, OREGON



REVISIONS:

PM. B BERRY  
 DR. M.FREY  
 JOB NO. 19004599  
 FILE NO. 19004599-TS02

SHEET NO.  
**FS-3**

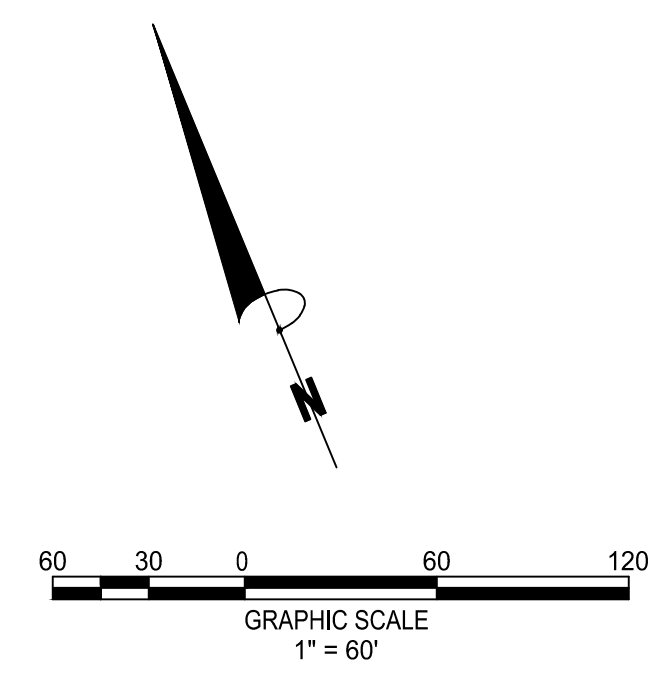



COPYRIGHT © 2020 ATWELL LLC. NO REPRODUCTION SHALL BE MADE WITHOUT THE PRIOR WRITTEN CONSENT OF ATWELL LLC.

K:\19004599 - parkway wood industrial park\utility\exhibits\2020-04-13 vehicle tracking\vehicle tracking.dwg Plotdate: 7/2/2020

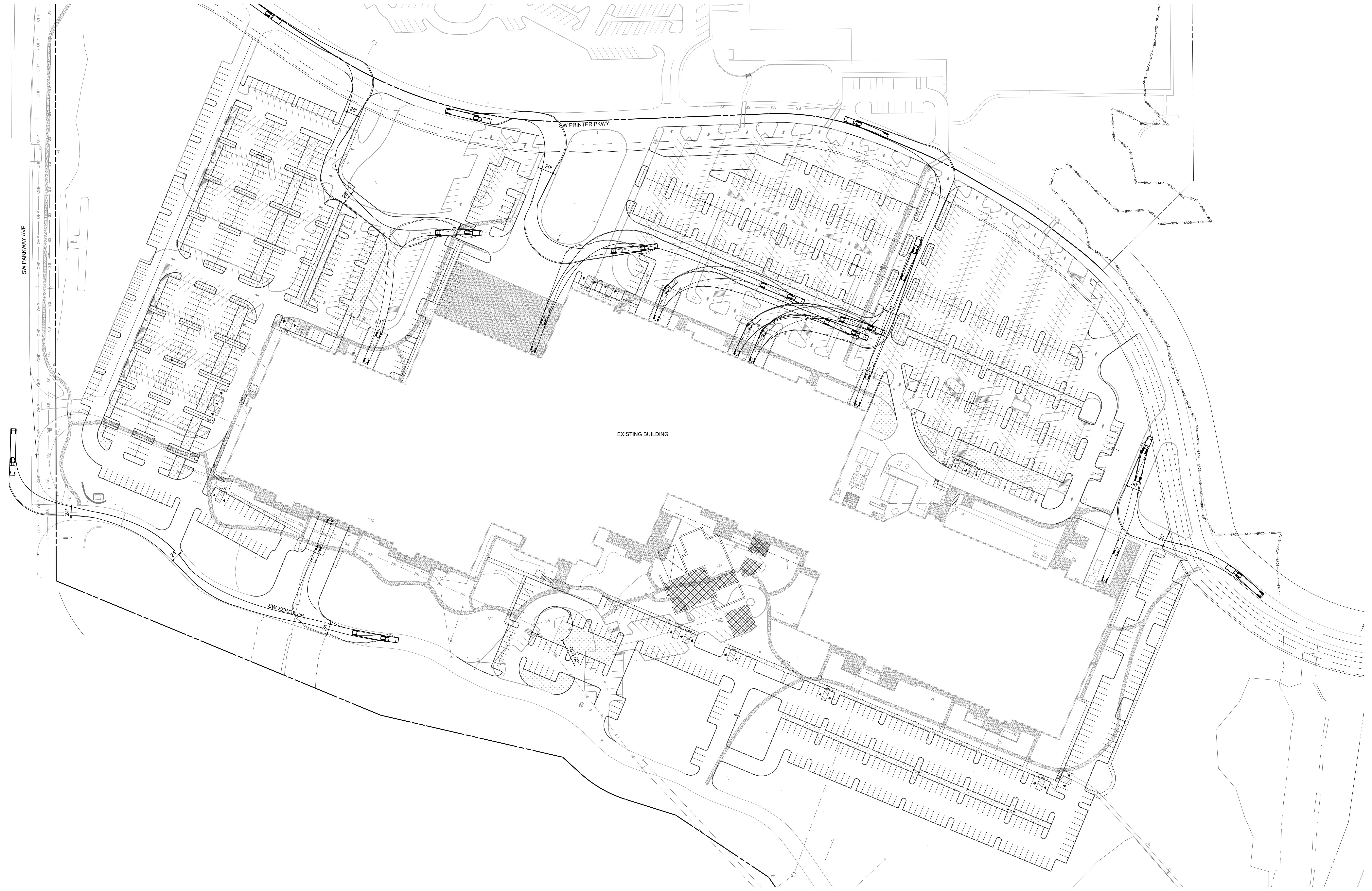

WB-67 SEMI-TRAILER TRUCK

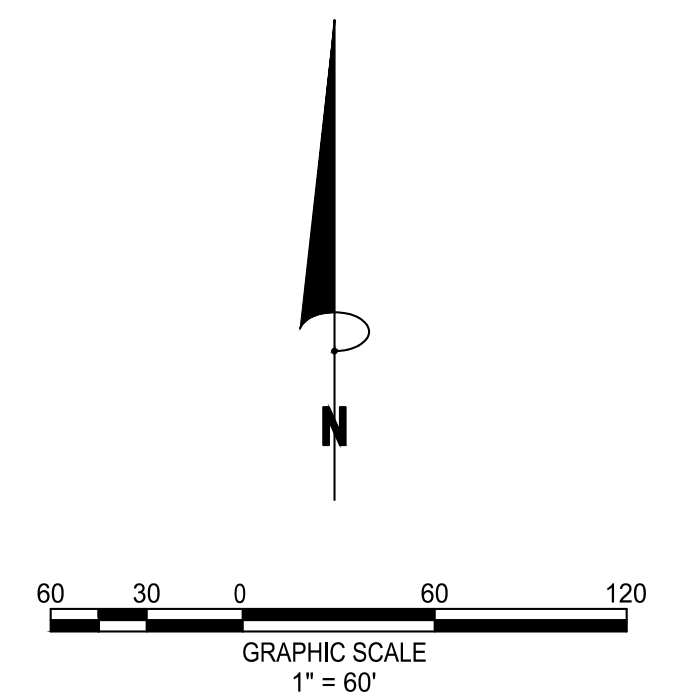

THE LOCATIONS OF EXISTING UNDERGROUND UTILITIES ARE SHOWN IN AN APPROXIMATE WAY ONLY AND HAVE NOT BEEN INDEPENDENTLY VERIFIED BY THE OWNER OR ITS ENGINEER. THE CONTRACTOR SHALL DETERMINE THE EXACT LOCATION OF ALL EXISTING UTILITIES BEFORE COMMENCING WORK, AND AGREE TO BE FULLY RESPONSIBLE FOR ANY AND ALL DAMAGES WHICH MIGHT BE OCCURRED BY THE CONTRACTOR'S FAILURE TO EXACTLY LOCATE AND PRESERVE ANY AND ALL UNDERGROUND UTILITIES.

NOTICE: CONSTRUCTION SITE SAFETY IS THE SOLE RESPONSIBILITY OF THE OWNER. NEITHER THE ENGINEER NOR THE ENGINEER SHALL BE EXPECTED TO ASSUME ANY RESPONSIBILITY FOR SAFETY OF THE WORK OF PERSONS ENGAGED IN THE WORK OF ANY NEARBY STRUCTURES, OR OF ANY OTHER PERSONS.



WB-67 SEMI-TRAILER TRUCK VEHICLE TRACKING EXHIBIT  
 EXHIBIT  
 PARKWAY WOODS INDUSTRIAL PARK  
 WILSONVILLE, OR



REVISIONS:

PM.	BB
DR.	JG
JOB NO.	19004599
FILE NO.	Vehicle Tracking



10295 Southwest Ridder Road Wilsonville, OR 97070  
o 503.570.0626 f 503.582.9307 republicservices.com

July 8, 2020

Kevin Apperson  
Atwell, LLC

Re: Parkway Woods Business Park  
2600 SW Parkway Ave.  
Wilsonville, OR 97070

Dear Kevin,

Thank you, for sending us the site plans for this proposed re-development in Wilsonville.

My Company: Republic Services of Clackamas and Washington Counties has the franchise agreement to service this area with the City of Wilsonville. We will provide complete commercial waste removal and recycling services as needed on a weekly basis for this location

I have reviewed the proposed parking re-design plans and do not see any negative impact on the existing trash and recycle locations #1 and #2 (see map). Assuming there will be no change in the trash and recycle composition of this complex, our trucks will be able to access and service locations #1, & #2.

Should your firm decide to proceed with new development of the proposed possible trash and recycle location #3, we will require further review of detailed design plans to ensure truck clearance and equipment access

Thanks Kevin, for your help and concerns for our services prior to this project being developed.

Sincerely,

A handwritten signature in blue ink, appearing to read "Kelly Herrod", written over a blue horizontal line.

Kelly Herrod  
Operations Supervisor  
Republic Services Inc.





RED BRICK  
MATCH EXISTING COLORS



BLACK STOREFRONT FRAME

BLACK METAL PAINT @ CANOPY

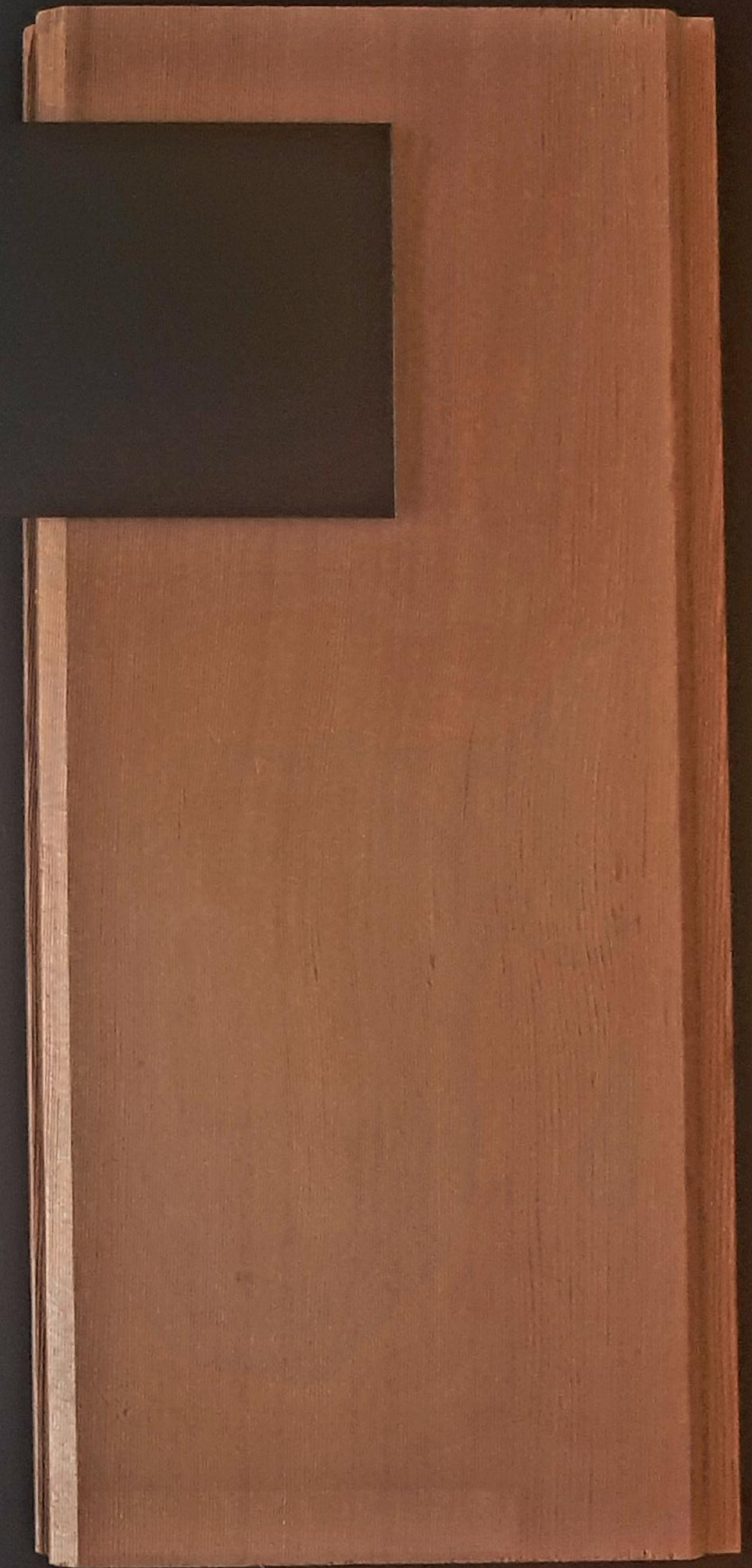

CEDAR SOFFIT / ACCENT WALL

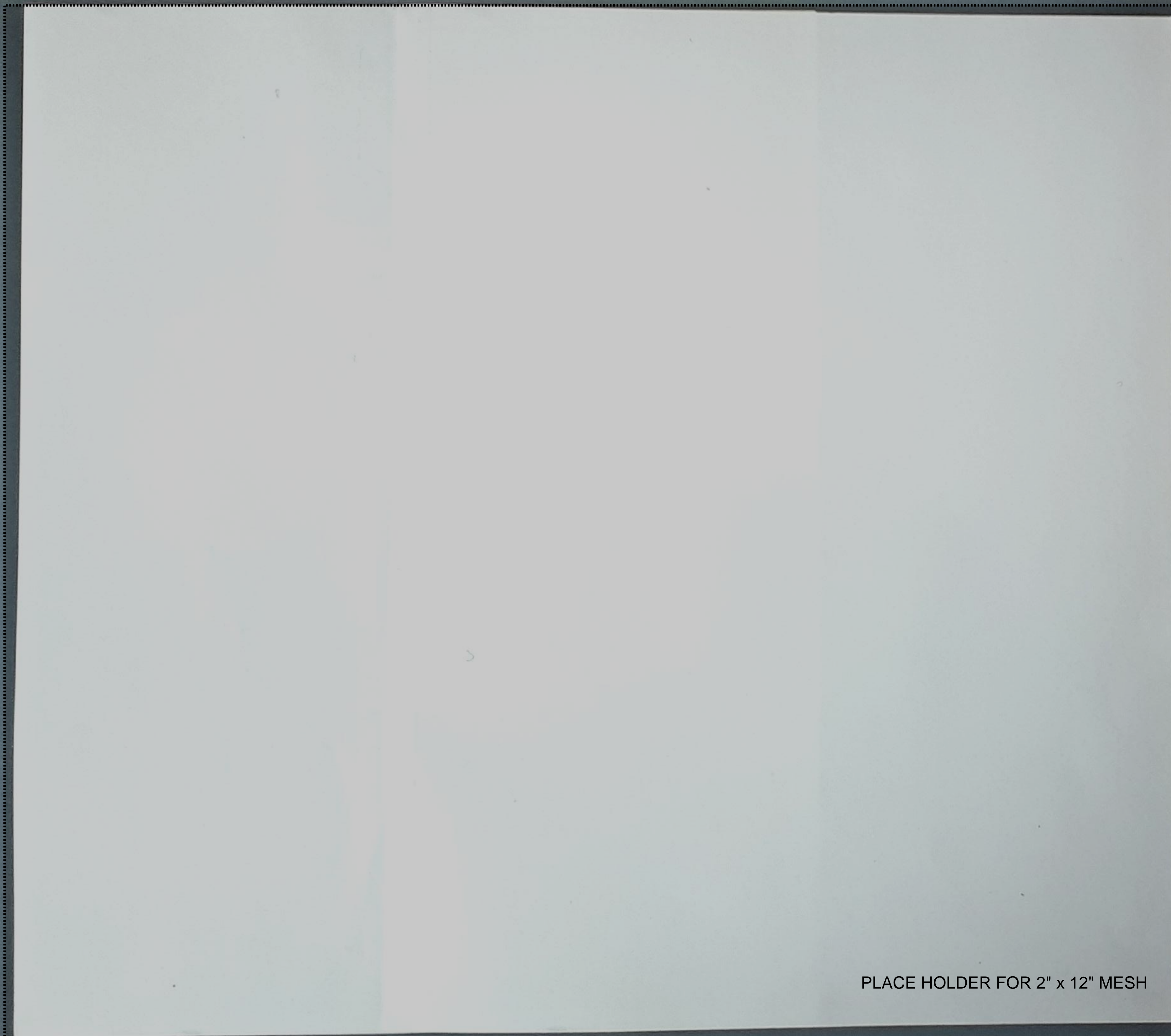

PLACE HOLDER FOR 2" x 12" MESH

MESH @ WEST ENTRY



**MAGLIN™**  
Site Furniture

[SUBSCRIBE](#) | [CONTACT US](#) | [SITE MAP](#) | [LOGIN](#) | [MY ACCOUNT](#) | [FRANÇAIS](#)

[PRODUCTS](#) | [COLLECTIONS](#) | [CUSTOM](#) | [COMPANY INFO](#) | [PORTFOLIO](#) | [QUICK QUOTE](#) | [RESOURCES](#)

## 700 SERIES - 720 CLUSTER SEATING



[PRODUCT INFO](#) | [CONFIGURE & QUOTE](#) | [DOWNLOAD FILES](#) | [COLOR CHART](#)

The **700 Series - 720 Cluster Seating** table top and accompanying bench seats (2) are manufactured using Ipe wood slats. The table and bench frames are solid cast aluminum, H.S. steel tube and flat bar.

### INSTALLATION TYPE & MATERIAL

- Ipe wood, Surface Mount - MTB-0720-00002 (MLPT720-S)
- Ipe wood, Direct Burial - MTB-0720-00001 (MLPT720-DB)

### OPTIONS

- Umbrella Hole

### DIMENSIONS

Table Height: 30.00" (76.2cm)  
Table Width: 37.00" (94cm)  
Total Length: 70.00" (178.0cm)  
Seat: 17.50" (44.45cm)

### FINISHES

All steel components are protected with E-Coat Rust Proofing. The Maglin Powdercoat System provides a durable finish on all metal surfaces. Ipe wood slats are finished with penetrating sealers.

### INSTALLATION

The 700 Series - 720 Cluster Seating surface mount tables are delivered pre-assembled. Tables with the direct burial option are shipped knocked down with minimal assembly required. Benches for both options are pre-assembled. Holes are provided in each foot for securing to base.

Material Type:

Model: MLPT720-DB

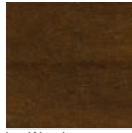

Ipe Wood

Select Table Installation Type to display a larger image:

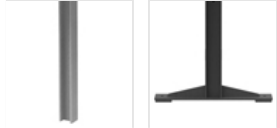

Direct Burial  Surface Mount



[ADD TO QUICK QUOTE](#)

[Login](#) to Maglin's Extranet to access our product library and Quick Quote System:  
(PDF, DWG, SKETCHUP, CSI SPEC, BIM OBJECTS)

Additional Files for Download:

- [MAGLIN\\_MLPT720](#)
- [MAGLIN\\_MLPT720-DB](#)
- [MAGLIN\\_MLPT720-S](#)
- [MAGLIN-MLPT720W](#)
- [MAGLIN-MLPT722W](#)
- [MAGLIN-MLPT721W](#)
- [MAGLIN\\_MLPT720-DB](#)

- PDF
- CSI SPEC
- CSI SPEC
- DWG
- DWG
- DWG
- SKETCHUP
- BIM
- OBJECTS
- BIM
- OBJECTS

- [METAL FINISHING PDF](#)
- [MLPT720 IMAGES](#)

[MAGLIN-MLPT721W](#)

[MAGLIN-MLPT722W](#)

**STANDARD MATERIAL COLORS**

**Wood**



IPE (W)



MLB720B-W



MLP400-W



MLWR700-32-WT



MLB720-W





**MAGLIN™**  
Site Furniture

[SUBSCRIBE](#) | [CONTACT US](#) | [SITE MAP](#) | [LOGIN](#) | [MY ACCOUNT](#) | [FRANÇAIS](#)

[PRODUCTS](#) | [COLLECTIONS](#) | [CUSTOM](#) | [COMPANY INFO](#) | [PORTFOLIO](#) | [QUICK QUOTE](#) | [RESOURCES](#)

## 700 SERIES - 720 BACKED CANTILEVER BENCH



[PRODUCT INFO](#)

[CONFIGURE & QUOTE](#)

[DOWNLOAD FILES](#)

[COLOR CHART](#)

The **700 Series - 720 Backed Cantilever Bench** ends are made from solid cast aluminum. The seat employs 1.38" x 1.5" (3.5cm x 3.8cm) and 1.38" x 4.00" (3.5cm x 10.2cm) lpe slats.

### DIMENSIONS

**MBE-0720-00010**

*MLB720CL-W*

Height: 27.56" (70cm)

Length: 69.75" (177.2cm)

Seat: 18" (45.7cm)

### WEIGHT

112.13lbs (50.9kg.)

### FINISHES

All steel components are protected with E-Coat Rust Proofing. The Maglin Powdercoat System provides a durable finish on all metal surfaces. lpe wood slats are finished with penetrating sealers.

### INSTALLATION

The 700 Series - 720 Backed Cantilever Bench is delivered pre-assembled. Holes (0.5") are provided in each mounting bracket for securing to base.

Seat Material:

Model: MLB720CL-W

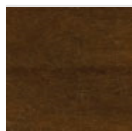

Ipe Wood



[ADD TO QUICK QUOTE](#)

[Login](#) to Maglin's Extranet to access our product library and Quick Quote System:  
(PDF, DWG, SKETCHUP, CSI SPEC, BIM OBJECTS)

Additional Files for Download:

- [MAGLIN\\_CUT\\_MLB720CL-W](#)
- [MAGLIN\\_CSI\\_MLB720CL-W](#)
- [MAGLIN\\_CAD\\_MLB720CL-W](#)
- [MAGLIN\\_SKP\\_MLB720CL-W](#)

- PDF
- CSI SPEC
- DWG
- SKETCHUP

[METAL FINISHING PDF](#)

**STANDARD POWDERCOAT COLORS**

**GLOSS**



**FINE TEXTURED (matte finish)**

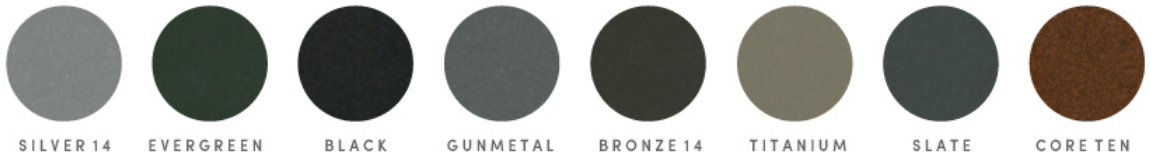

\*Fine Textured paint is available for an upcharge  
\*\*Vinyl graphics are not recommended on Fine Textured Powdercoat

Refer to [Resources/Powdercoat Colors](#) for full color chart  
**STANDARD MATERIAL COLORS**

**Wood**







**MAGLIN™**  
Site Furniture

[SUBSCRIBE](#) | [CONTACT US](#) | [SITE MAP](#) | [LOGIN](#) | [MY ACCOUNT](#) | [FRANÇAIS](#)

[PRODUCTS](#) | [COLLECTIONS](#) | [CUSTOM](#) | [COMPANY INFO](#) | [PORTFOLIO](#) | [QUICK QUOTE](#) | [RESOURCES](#)

## 700 SERIES - 720 BACKLESS WALL MOUNT BENCH



### PRODUCT INFO

### CONFIGURE & QUOTE

### DOWNLOAD FILES

### COLOR CHART

The **700 Series - 720 Backless Wall Mount Bench** ends are made from solid cast aluminum. The seat employs 1.38" x 1.5" (3.5cm x 3.8cm) and 1.38" x 4.00" (3.5cm x 10.2cm) lpe slats.

#### ACCESSORIES

- Skate Deterrent

#### DIMENSIONS

**MBE-0720-00005**

*MLB720BL-W*

Height: 3.63" (9.3cm)

Length: 70.00" (177.7cm)

Width: 21.25" (54.0cm)

#### WEIGHT

73.30lbs (31.9kg.)

#### FINISHES

All steel components are protected with E-Coat Rust Proofing. The Maglin Powdercoat System provides a durable finish on all metal surfaces. Ipe wood slats are finished with penetrating sealers.

#### INSTALLATION

The 700 Series - 720 Backless Wall Mount Benches are delivered pre-assembled. Mounting brackets can be configured for proposed mounting surface.

Seat Material:

Model: MLB720BL-W



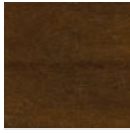

Ipe Wood

Options:



Skate Deterrent



[ADD TO QUICK QUOTE](#)

[Login](#) to Maglin's Extranet to access our product library and Quick Quote System:  
(PDF, DWG, SKETCHUP, CSI SPEC, BIM OBJECTS)

Additional Files for Download:

- [MAGLIN CUT\\_MLB720BL-W](#)
- [MAGLIN CSI\\_MLB720BL-W](#)
- [MAGLIN CAD\\_MLB720BL-W](#)
- [MAGLIN SKP\\_MLB720BL-W](#)
- [MAGLIN-MLB720BLW](#)

- PDF
- CSI SPEC
- DWG
- SKETCHUP
- BIM
- OBJECTS

- [METAL FINISHING PDF](#)
- [MLB720BL IMAGES](#)





# Monoslope

low pitch rectangular shelter  
MSL, MSE, MSX



**Design Intent:**  
Simple rectangular monoslope structure to enable maximum picnic table capacity underneath, at an economy price.

**Standard With This Shelter:**

- Steel columns and frame members coated with super-durable Poli-5000 powder coat finish.

- |  |  |
|--|--|
| <p><b>Primary Roof Options:</b></p> <ul style="list-style-type: none"> <li>• Tongue-and-Groove</li> <li>• Structural Insulated Panels</li> <li>• Multi-Rib</li> <li>• Mega-Rib</li> <li>• Standing Seam</li> </ul> | <p><b>Secondary Roofing Options:</b></p> <ul style="list-style-type: none"> <li>• Multi-Rib</li> <li>• Standing Seam</li> <li>• Mega-Rib</li> <li>• Asphalt or Cedar Shingles</li> </ul> |
|--|--|

**Shelter Modifications:**  
Shelter can be modified by changing pitch, adding a cupola, railing, integrated seating, ornamentation\*\*, gutters, lightning protection, electrical cut-outs, windscreens, walls, an increase in clearance height, or by selecting a different column design from our offering.

\*Addition of ornamentation increases building height by 10".

## Monoslope MSE, MSL, MSX

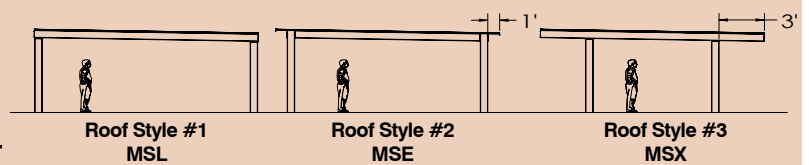
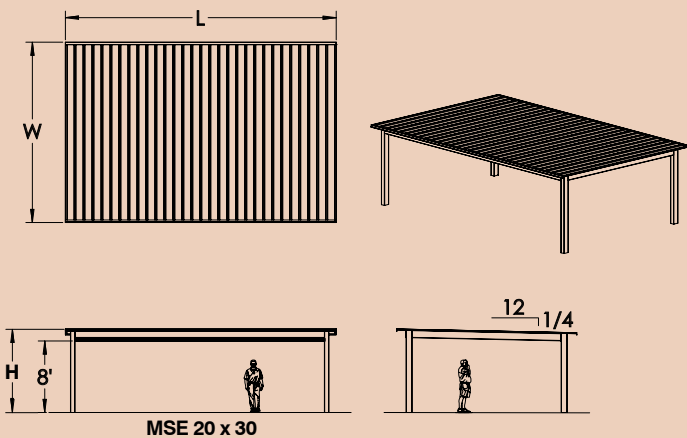

BIN	W	L	Height	Sq. Ft.
MSL	10	21	8'-9"	210
MSL	16	30	8'-11"	480
MSL	20	30	9'-3"	600
MSL	26	30	9'-3"	780
MSE	10	21	8'-10"	210
MSE	16	30	9'-2"	480
MSE	20	30	9'-4"	600
MSE	26	30	9'-5"	780
MSX	16	30	9'-4"	300
MSX	20	30	9'-5"	600
MSX	26	30	9'-6"	730

Height is approximate and for reference only.



**MAGLIN™**  
Site Furniture

[SUBSCRIBE](#) | [CONTACT US](#) | [SITE MAP](#) | [LOGIN](#) | [MY ACCOUNT](#) | [FRANÇAIS](#)

[PRODUCTS](#) | [COLLECTIONS](#) | [CUSTOM](#) | [COMPANY INFO](#) | [PORTFOLIO](#) | [QUICK QUOTE](#) | [RESOURCES](#)

## LEXICON COLLECTION: 3 STREAM TRASH / RECYCLE RECEPTACLE



[PRODUCT INFO](#) | [CONFIGURE & QUOTE](#) | [DOWNLOAD FILES](#) | [COLOR CHART](#)

The **1500 Series - Lexicon Recycle Receptacle** is constructed using a steel frame with laser cut and formed steel body panels. Three 16 gallon commercial grade plastic liners and standard metal lids are provided.

### FEATURES

- Rodent Resistant
- Lockable Doors

### OPTIONS

- Standard MRR-1500-00013 (*LXRC1503-48-MS-LD0ST-LD0ST-LD0ST*)
- Rain Shield MRR-1500-00014 (*LXRC1503-48-MS-LD0ST-LD0ST-LD0ST-RS*)
- Vinyl Graphics MRR-1500-00015 (*LXRC1503-48-MS-VGST-VGST-VGST*)
- Vinyl Graphics, Rain Shield MRR-1500-00016 (*LXRC1503-48-MS-VGST-VGST-VGST-RS*)

### DIMENSIONS & WEIGHT

Height: 37" (94.0cm)  
Length: 34.88" (88.6cm)  
Depth: 19" (48.3cm)  
Liner Capacity: 3 x 16 Gallons (3 x 60 Litres)  
Weight: 182.20lbs (82.6kg)

### FINISHES

All steel components are protected with E-Coat Rust Proofing. The Maglin Powdercoat System provides a durable finish on all metal surfaces.

### INSTALLATION

The trash/recycle container is delivered pre-assembled. Holes (9/16") are provided in each mounting foot for securing to base.

Door Options:



- No Graphics
- Vinyl Graphics

Vinyl Options:

Choice of three vinyl graphics per container

Solid Vinyl



- Trash
- Bottle
- Paper



- Cans
- Organics

Outline Vinyl



- Trash
- Bottle
- Paper



- Cans
- Organics

Lid Options:



Rain Shield  
LXRC1503-48-MS-RS

[Login](#) to Maglin's Extranet to access our product library and Quick Quote System:  
(PDF, DWG, SKETCHUP, CSI SPEC, BIM OBJECTS)

- [MAGLIN CUT LXRC1503-48-MS-RS](#)
  - [MAGLIN CUT LXRC1503-48-MS](#)
  - [MAGLIN CSI LXRC1503-48-MS](#)
  - [MAGLIN CSI LXRC1503-48-MS-RS](#)
  - [MAGLIN CAD LXRC1503-48-MS-LD0ST-LD0ST-LD0ST](#)
  - [MAGLIN CAD LXRC1503-48-MS-LD0ST-LD0ST-LD0ST-RS](#)
- STANDARD POWDERCOAT COLORS**

**GLOSS**



- SILVER 14
- EVERGREEN
- BLACK
- GUNMETAL
- BRONZE 14
- TITANIUM
- GRAPHITE

**FINE TEXTURED (matte finish)**

Model: LXRC1503-48-MS-LD0ST-LD0ST-LD0ST



ADD TO QUICK QUOTE

**Additional Files for Download:**

- [METAL FINISHING PDF](#)
- [INSTALLATION INSTRUCTIONS](#)
- [SKETCHUP ASSEMBLY INSTRUCTIONS](#)

- PDF
- PDF
- CSI SPEC
- CSI SPEC
- DWG
- DWG



SILVER 14    EVERGREEN    BLACK    GUNMETAL    BRONZE 14    TITANIUM    SLATE    CORE TEN

\*Fine Textured paint is available for an upcharge  
\*\*Vinyl graphics are not recommended on Fine Textured Powdercoat

Refer to [Resources/Powdercoat Colors](#) for full color chart



LXM1500-SS SERIES    LXM1500-SC SERIES    LXM1500-MPR-R3    LXRC1500-32-MS SERIES    LXRC1502-48-MS SERIES

## ICONIC COLLECTION: Bike Rack



- POWDERCOAT C
- MATERIAL COLC
- METAL FINISHIN
- IPERWOOD
- THERMAL WOOE
- RECYCLED PLAS
- PAPER COMPOS
- CHROMA
- MATERIAL COMF
- PLAQUES
- ENVIRONMENTA
- WORKING WITH
- CARE & MAINTEN
- BOLT KIT INSTRU
- WARRANTY

- PRODUCT INFO
- RESOURCES
- COLOR CHART

The **Iconic Bike Rack** is made from solid cast aluminum. Bikes can be attached from either side allowing ease of use. Brackets and tamper resistant fasteners are made from steel and stainless steel.

### [DIMENSIONS & WEIGHT](#)

- Height: 26 1/2" (67.3cm)
- Length: 20 1/2" (52cm)
- Width: 2" (5.1cm)
- Weight: 18lbs (8kg)

### [FINISHES](#)

The Maglin Powdercoat System provides a durable finish on all aluminum castings.

### [INSTALLATION](#)

The 2300 Series - Iconic Bike Rack is delivered in parts. Reference installation instructions for more information.

### [ORDER](#)

Contact your Maglin representative for specifications and pricing.

[Login](#) to Maglin's Extranet to access our product library and download files.

[AVAILABLE DOWNLOADS](#)



MBR-2300-00001 CUTSHEET



MBR-2300-00001 SKETCHUP



MBR-2300-00001 DWG



MBR-2300-00001 INSTALLATION INSTRUCTIONS

STANDARD POWDERCOAT COLLECTION

Gloss Collection



SILVER 14    BLACK    GUNMETAL    TITANIUM    BRONZE 14

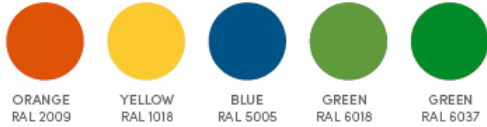

ORANGE RAL 2009    YELLOW RAL 1018    BLUE RAL 5005    GREEN RAL 6018    GREEN RAL 6037



RED RAL 3002    WHITE RAL 9016    MAGENTA RAL 4010    TURQUOISE RAL 5018

Fine Textured Collection\* (matte finish)



SILVER 14    BLACK    GUNMETAL    TITANIUM    BRONZE 14







MESH @ WEST ENTRY

CEDAR SOFFIT

WEST ENTRY



CEDAR SOFFIT / ACCENT WALL

BLACK METAL PAINT @CANOPY

CORNER ENTRY

RED BRICK - MATCH EXISTING COLOTRS

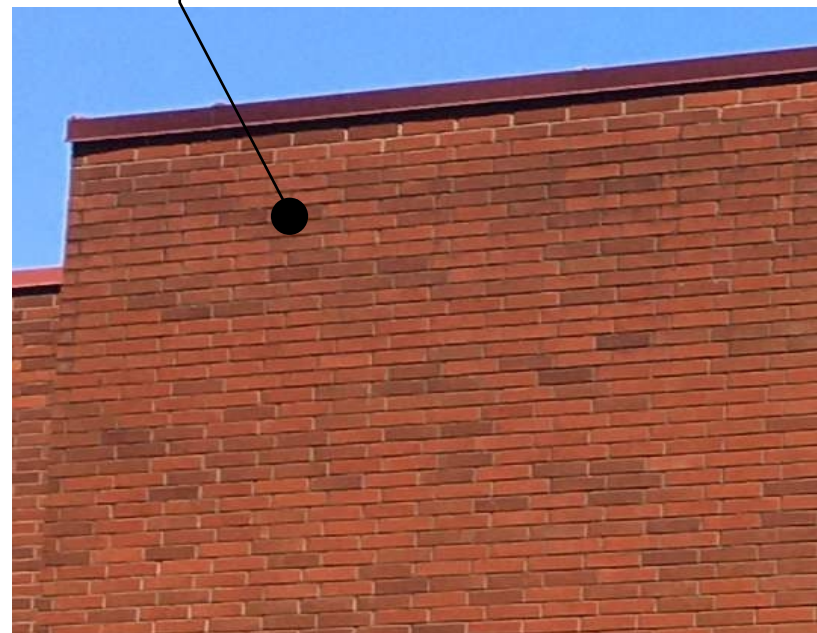

EXISTING BRICK

BLACK STOREFRONT FRAME



STOREFRONT FRAMING

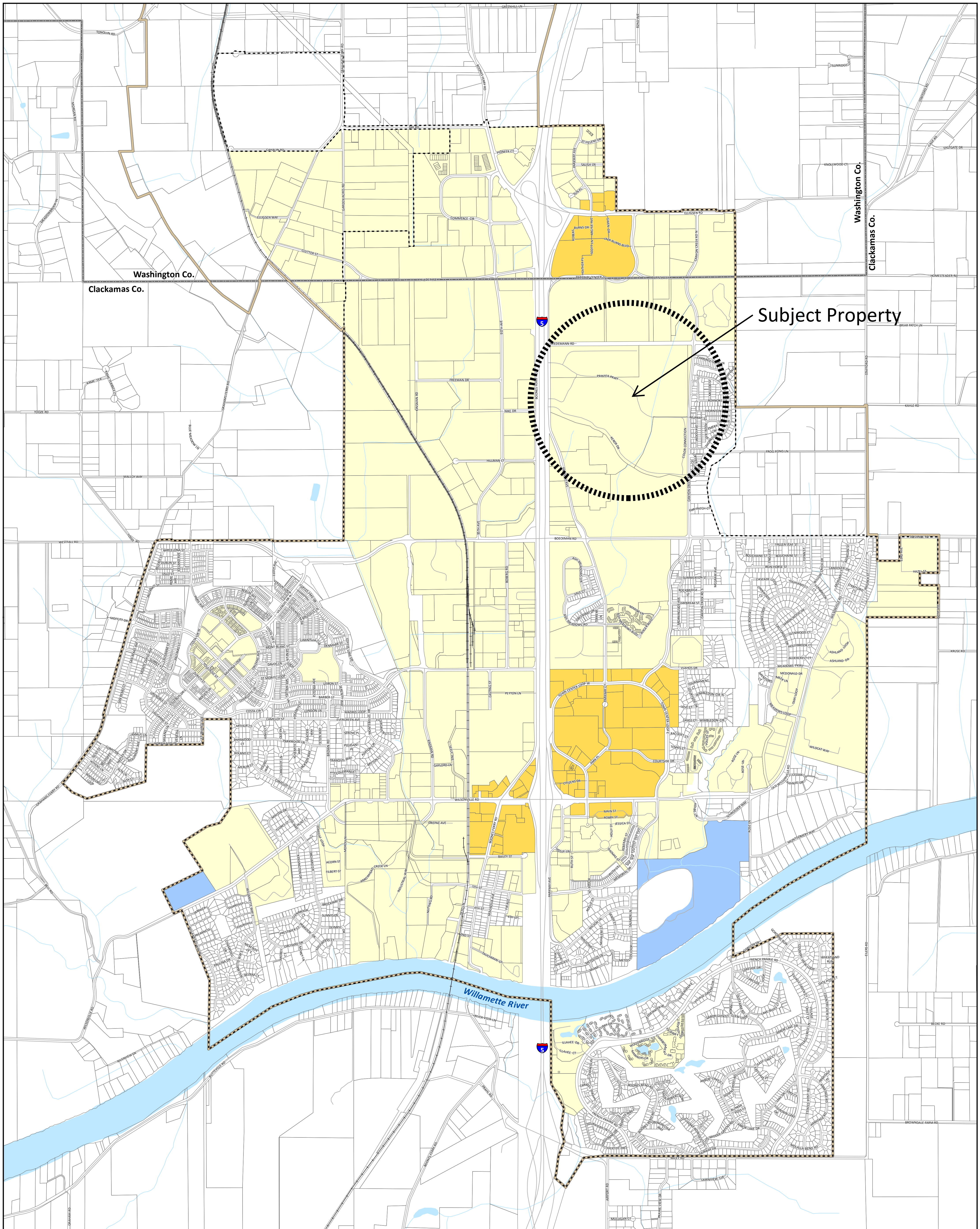

# Lighting Overlay Zones



0 0.5 Mile

December 2017

## Map Legend

- LZ 1
- LZ 2
- LZ 3
- County Boundary
- City Boundary
- Urban Growth Boundary
- Taxlots



This map is to be used in conjunction with written code provided in Section 4.199.30 of the Wilsonville Planning and Land Development Ordinance.

Disclaimer: The City of Wilsonville makes no representations, express or implied, as to the accuracy, completeness and timeliness of the information displayed. Data errors and omissions may exist in map and report. This map is not suitable for legal, engineering, or surveying purposes. Please contact the City of Wilsonville Planning Division to verify report information is complete and accurate.



# D-Series Size 2 LED Area Luminaire

d<sup>2</sup>series



## Specifications

<b>EPA:</b>	1.1 ft <sup>2</sup> (0.10 m <sup>2</sup> )
<b>Length:</b>	40" (101.6 cm)
<b>Width:</b>	15" (38.1 cm)
<b>Height 1:</b>	7-1/4" (18.4 cm)
<b>Height 2: (max):</b>	3.5"
<b>Weight:</b>	36lbs

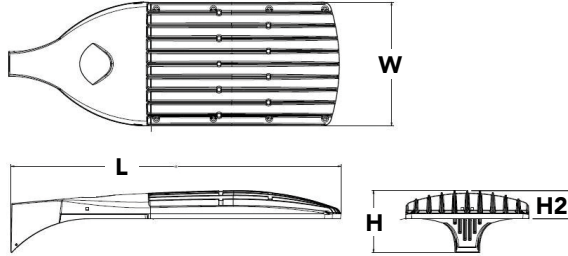

Catalog  
Number

Notes

Type

Hit the Tab key or mouse over the page to see all interactive elements.

## Introduction

The modern styling of the D-Series is striking yet unobtrusive - making a bold, progressive statement even as it blends seamlessly with its environment.

The D-Series distills the benefits of the latest in LED technology into a high performance, high efficacy, long-life luminaire. The outstanding photometric performance results in sites with excellent uniformity, greater pole spacing and lower power density. The Size 2 is ideal for replacing 400-1000W metal halide in area lighting applications with energy savings of up to 80% and expected service life of over 100,000 hours.

A+ Capable options indicated by this color background.

## Ordering Information

**EXAMPLE:** DSX2 LED P7 40K T3M MVOLT SPA NLTAIR2 PIRHN DDBXD

Series	LEDs	Color temperature	Distribution	Voltage	Mounting	
<b>DSX2 LED</b>	<b>Forward optics</b> P1 P5 <b>P2</b> P6 P3 P7 P4 P8 <b>Rotated optics<sup>1</sup></b> P10 P13 P11 P14 P12	30K 3000 K <b>40K</b> <b>4000 K</b> 50K 5000 K	T1S Type I Short (Automotive) T2S Type II Short T2M Type II Medium T3S Type III Short T3M Type III Medium <b>T4M</b> <b>Type IV Medium</b> TFTM Forward Throw Medium	T5VS Type V Very Short <sup>2</sup> T5S Type V Short <sup>2</sup> T5M Type V Medium <sup>2</sup> T5W Type V Wide <sup>2</sup> BLC Backlight control <sup>3</sup> LCCO Left corner cutoff <sup>3</sup> RCCO Right corner cutoff <sup>3</sup>	<b>MVOLT<sup>4</sup></b> 120 <sup>5</sup> 208 <sup>5</sup> 240 <sup>5</sup> 277 <sup>5</sup> 347 <sup>5</sup> 480 <sup>5</sup>	<b>Shipped included</b> SPA Square pole mounting RPA Round pole mounting WBA Wall bracket <sup>2</sup> SPUMBA Square pole universal mounting adaptor <sup>6</sup> RPUMBA Round pole universal mounting adaptor <sup>6</sup> <b>Shipped separately</b> KMA8 DDBXD U Mast arm mounting bracket adaptor (specify finish) <sup>7</sup>

Control options	Other options	Finish (required)
<b>Shipped installed</b> NLTAIR2 nLight AIR generation 2 enabled <sup>8</sup> PIRHN Network, Bi-Level motion/ambient sensor <sup>9</sup> PER NEMA twist-lock receptacle only (no controls) <sup>10</sup> PER5 Five-wire receptacle only (no controls) <sup>10,11</sup> PER7 Seven-wire receptacle only (no controls) <sup>10,11</sup> DMG 0-10V dimming extend out back of housing for external control (no controls) <sup>12</sup> DS Dual switching <sup>13,14</sup>	<b>Shipped installed</b> HS House-side shield <sup>16</sup> SF Single fuse (120, 277, 347V) <sup>5</sup> DF Double fuse (208, 240, 480V) <sup>5</sup> L90 Left rotated optics <sup>1</sup> R90 Right rotated optics <sup>1</sup> <b>Shipped separately</b> BS Bird spikes <sup>17</sup> EGS External glare shield	DDBXD Dark bronze DBLXD Black DNAXD Natural aluminum DWHXD White DDBTXD Textured dark bronze DBLBXD Textured black DNATXD Textured natural aluminum DWHGXD Textured white



One Lithonia Way • Conyers, Georgia 30012 • Phone: 1-800-705-SERV (7378) • [www.lithonia.com](http://www.lithonia.com)  
© 2011-2020 Acuity Brands Lighting, Inc. All rights reserved.

DSX2-LED  
Rev. 02/05/20  
Page 1 of 8

## Ordering Information

### Accessories

Ordered and shipped separately.

DLL127F 1.5 JU	Photocell - SSL twist-lock (120-277V) <sup>18</sup>
DLL347F 1.5 CUL JU	Photocell - SSL twist-lock (347V) <sup>18</sup>
DLL480F 1.5 CUL JU	Photocell - SSL twist-lock (480V) <sup>18</sup>
DSHORT SBK U	Shorting cap <sup>18</sup>
DSX2HS 80C U	House-side shield for 80 LED unit <sup>19</sup>
DSX2HS 90C U	House-side shield for 90 LED unit <sup>19</sup>
DSX2HS 100C U	House-side shield for 100 LED unit <sup>19</sup>
PUMBA DDBXD U*	Square and round pole universal mounting bracket (specify finish) <sup>20</sup>
KMA8 DDBXD U	Mast arm mounting bracket adaptor (specify finish) <sup>4</sup>
DSX2EGS (FINISH) U	External glare shield

For more control options, visit [DTL](#) and [ROAM](#) online.

### NOTES

- P10, P11, P12, P13 or P14 and rotated optics (L90, R90) only available together.
- Any Type 5 distribution with photocell, is not available with WBA.
- Not available with HS.
- MVOLT driver operates on any line voltage from 120-277V (50/60 Hz).
- Single fuse (SF) requires 120V, 277V or 347V. Double fuse (DF) requires 208V, 240V or 480V.
- Universal mounting bracket intended for retrofit on existing pre-drilled poles only. 1.5 G vibration load rating per ANCI C136.31.
- Must order fixture with SPA option. Must be ordered as a separate accessory; see Accessories information. For use with 2-3/8" mast arm (not included).
- Must be ordered with PIRHN. Sensor cover only available in dark bronze, black, white or natural aluminum color.
- Must be ordered with NLTAIR2. For more information on nLight Air 2 visit [this link](#).
- Photocell ordered and shipped as a separate line item from Acuity Brands Controls. See accessories. Not available with DS option. Shorting Cap included.
- If ROAM® node required, it must be ordered and shipped as a separate line item from Acuity Brands Controls. Node with integral dimming.
- DMG not available with PIRHN, PER5, PER7, PIR, PIRH, PIR1FC3V or PIRH1FC3V.
- Requires (2) separately switched circuits with isolated neutrals. See Outdoor Control Technical Guide for details.
- Provides 50/50 fixture operation via (2) independent drivers. Not available with PER, PER5, PER7, PIR or PIRH. Not available with P1, P2, P10.
- Reference controls options table on page 4.
- Not available with BLC, LCCO and RCCO distribution. Also available as a separate accessories; see Accessories information.
- Must be ordered with fixture for factory pre-drilling.
- Requires luminaire to be specified with PER, PER5 and PER7 option. Ordered and shipped as a separate line item from Acuity Brands Controls.
- Not available with other dimming controls options.
- For retrofit use only.

## Options

### EGS - External Glare Shield

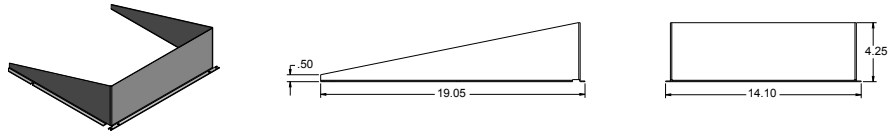

## Drilling

### HANDHOLE ORIENTATION

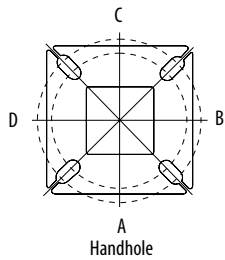

### Tenon Mounting Slipfitter\*\*

Tenon O.D.	Mounting	Single Unit	2 @ 180	2 @ 90	3 @ 120	3 @ 90	4 @ 90
2-3/8"	SPA/RPA	AS3-5 190	AS3-5 280	AS3-5 290	AS3-5 320	AS3-5 390	AS3-5 490
	SPUMBA	AS3-5 190	AS3-5 280	AS4-5 290	AS3-5 320	AS4-5 390	AS4-5 490
	RUPUMBA	AS3-5 190	AS3-5 280		AS3-5 320		
2-7/8"	SPA/RPA	AST25-190	AST25-280	AST25-290	AST25-320	AST25-390	AST25-490
	SPUMBA	AST25-190	AST25-280		AST25-320		
	RUPUMBA	AST25-190	AST25-280		AST25-320		
4"	SPA/RPA	AST35-190	AST35-280	AST35-290	AST35-320	AST35-390	AST35-490
	SPUMBA	AST35-190	AST35-280	AST35-290	AST35-320	AST35-390	AST35-490
	RUPUMBA	AST35-190	AST35-280		AST35-320		

Mounting Option	Drilling Template	Single	2 @ 180	2 @ 90	3 @ 90	3 @ 120	4 @ 90
Head Location		Side B	Side B & D	Side B & C	Side B, C & D	Round Pole Only	Side A, B, C & D
Drill Nomenclature	#8	DM19AS	DM28AS	DM29AS	DM39AS	DM32AS	DM49AS

	Drilling Template	Minimum Acceptable Outside Pole Dimension					
SPA	#8	2-7/8"	2-7/8"	3.5"	3.5"	3"	3.5"
RPA	#8	2-7/8"	2-7/8"	3.5"	3.5"	3"	3.5"
SPUMBA	#5	2-7/8"	3"	4"	4"	3.5"	4"
RPUMBA	#5	2-7/8"	3.5"	5"	5"	3.5"	5"

Template #8

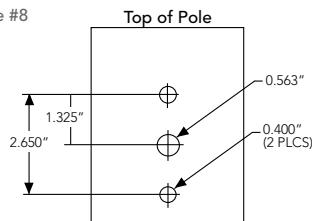

Isofootcandle plots for the DSX2 LED 80C 1000 40K. Distances are in units of mounting height (30').

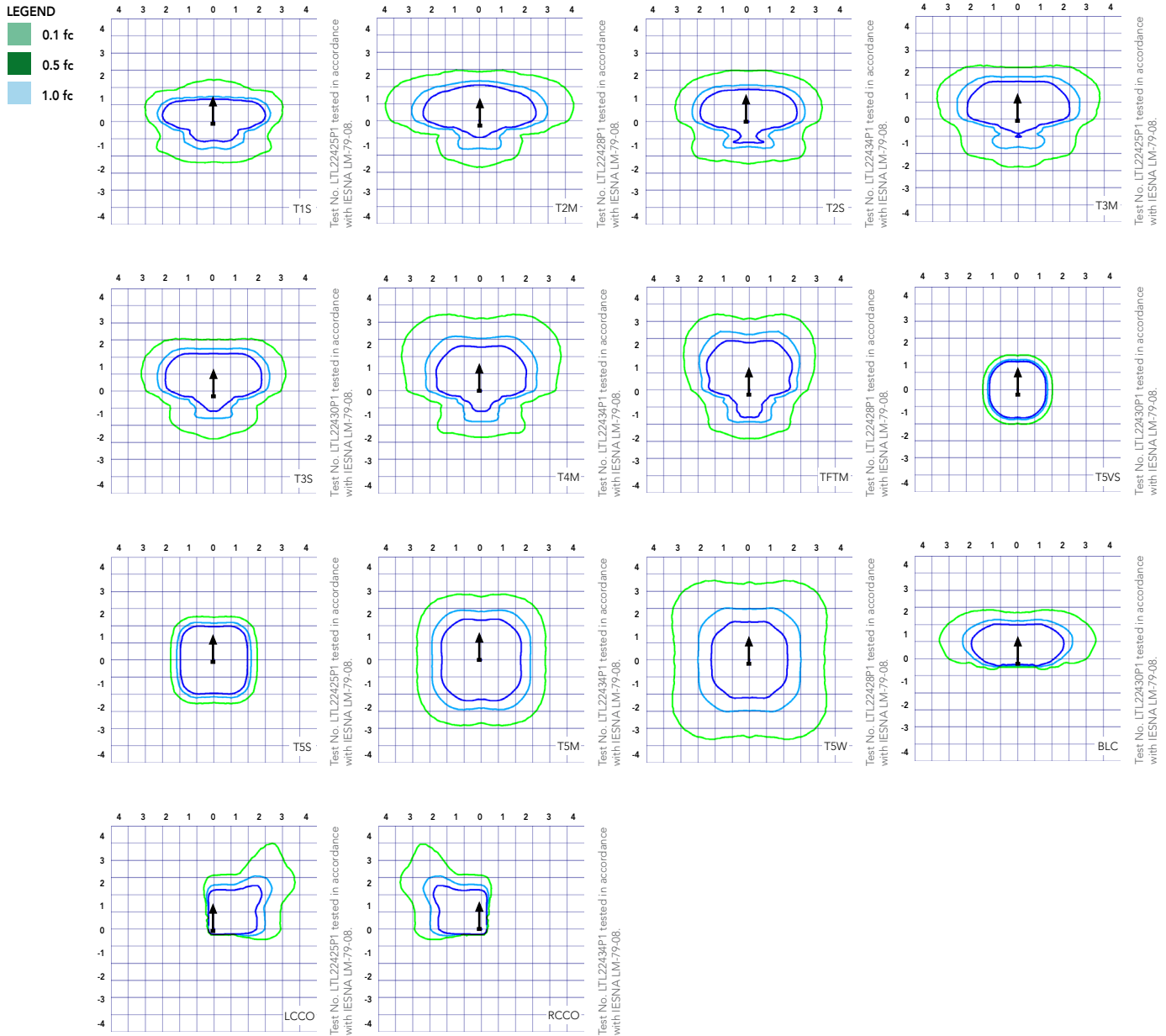

## Performance Data

### Lumen Ambient Temperature (LAT) Multipliers

Use these factors to determine relative lumen output for average ambient temperatures from 0-40°C (32-104°F).

Ambient		Lumen Multiplier
0°C	32°F	1.04
5°C	41°F	1.04
10°C	50°F	1.03
15°C	59°F	1.02
20°C	68°F	1.01
<b>25°C</b>	<b>77°F</b>	<b>1.00</b>
30°C	86°F	0.99
35°C	95°F	0.98
40°C	104°F	0.97

### Projected LED Lumen Maintenance

Data references the extrapolated performance projections for the platforms noted in a **25°C ambient**, based on 10,000 hours of LED testing (tested per IESNA LM-80-08 and projected per IESNA TM-21-11).

To calculate LLF, use the lumen maintenance factor that corresponds to the desired number of operating hours below. For other lumen maintenance values, contact factory.

Operating Hours	0	25000	50000	100000
Lumen Maintenance Factor	1.00	0.96	0.92	0.85

### Electrical Load

	Performance Package	LED Count	Drive Current	Wattage	Current (A)					
					120	208	240	277	347	480
Forward Optics (Non-Rotated)	P1	80	530	140	1.18	0.68	0.59	0.51	0.40	0.32
	P2	80	700	185	1.56	0.90	0.78	0.66	0.52	0.39
	P3	80	850	217	1.82	1.05	0.90	0.80	0.63	0.48
	P4	80	1050	270	2.27	1.31	1.12	0.99	0.79	0.59
	P5	80	1250	321	2.68	1.54	1.34	1.17	0.93	0.68
	P6	100	1050	343	2.89	1.66	1.59	1.37	1.00	0.71
	P7	100	1250	398	3.31	1.91	1.66	1.45	1.16	0.81
	P8	100	1350	431	3.61	2.07	1.81	1.57	1.25	0.91
Rotated Optics (Requires L90 or R90)	P10	90	530	156	1.30	0.76	0.65	0.62	0.45	0.32
	P11	90	700	207	1.75	1.01	0.87	0.74	0.60	0.46
	P12	90	850	254	2.12	1.22	1.06	0.94	0.73	0.55
	P13	90	1200	344	2.88	1.65	1.44	1.25	1.00	0.73
	P14	90	1400	405	3.39	1.95	1.71	1.48	1.18	0.86

Motion Sensor Default Settings						
Option	Dimmed State	High Level (when triggered)	Photocell Operation	Dwell Time	Ramp-up Time	Ramp-down Time
PIR or PIRH	3V (37%) Output	10V (100%) Output	Enabled @ 5FC	5 min	3 sec	5 min
*PIR1FC3V or PIRH1FC3V	3V (37%) Output	10V (100%) Output	Enabled @ 1FC	5 min	3 sec	5 min

\*for use when motion sensor is used as dusk to dawn control.

Controls Options				
Nomenclature	Description	Functionality	Primary control device	Notes
FAO	Field adjustable output device installed inside the luminaire; wired to the driver dimming leads.	Allows the luminaire to be manually dimmed, effectively trimming the light output.	FAO device	Cannot be used with other controls options that need the 0-10V leads
DS	Drivers wired independently for 50/50 luminaire operation	The luminaire is wired to two separate circuits, allowing for 50/50 operation.	Independently wired drivers	Requires two separately switched circuits. Consider nLight AIR as a more cost effective alternative.
PERS or PER7	Twist-lock photocell receptacle	Compatible with standard twist-lock photocells for dusk to dawn operation, or advanced control nodes that provide 0-10V dimming signals.	Twist-lock photocells such as DLL Elite or advanced control nodes such as ROAM.	Pins 4 & 5 to dimming leads on driver, Pins 6 & 7 are capped inside luminaire
PIR or PIRH	Motion sensors with integral photocell. PIR for 8-15' mounting; PIRH for 15-30' mounting	Luminaires dim when no occupancy is detected.	Acuity Controls SBGR	Also available with PIRH1FC3V when the sensor photocell is used for dusk-to-dawn operation.
NLTAIR2 PIRHN	nLight AIR enabled luminaire for motion sensing, photocell and wireless communication.	Motion and ambient light sensing with group response. Scheduled dimming with motion sensor over-ride when wirelessly connected to the nLight Eclipse.	nLight Air rSBGR	nLight AIR sensors can be programmed and commissioned from the ground using the CIAIRity Pro app.

# Performance Data

## Lumen Output

Lumen values are from photometric tests performed in accordance with IESNA LM-79-08. Data is considered to be representative of the configurations shown, within the tolerances allowed by Lighting Facts. Contact factory for performance data on any configurations not shown here.

Forward Optics																							
LED Count	Drive Current	Power Package	System Watts	Dist. Type	30K (3000 K, 70 CRI)					40K (4000 K, 70 CRI)					50K (5000 K, 70 CRI)								
					Lumens	B	U	G	LPW	Lumens	B	U	G	LPW	Lumens	B	U	G	LPW				
80	530	P1	140W	T1S	17,575	3	0	3	126	18,933	3	0	3	135	19,173	3	0	3	137				
				T2S	17,556	3	0	3	125	18,913	3	0	3	135	19,152	3	0	3	137				
				T2M	17,647	3	0	3	126	19,010	3	0	3	136	19,251	3	0	3	138				
				T3S	17,090	3	0	3	122	18,411	3	0	3	132	18,644	3	0	3	133				
				T3M	17,604	3	0	3	126	18,964	3	0	3	135	19,204	3	0	3	137				
				T4M	17,221	3	0	3	123	18,552	3	0	4	133	18,787	3	0	4	134				
				TFTM	17,593	3	0	3	126	18,952	3	0	4	135	19,192	3	0	4	137				
				TSVS	18,297	4	0	1	131	19,711	4	0	1	141	19,961	4	0	1	143				
				T5S	18,312	4	0	2	131	19,727	4	0	2	141	19,977	4	0	2	143				
				T5M	18,266	4	0	2	130	19,677	4	0	2	141	19,926	4	0	2	142				
				TSW	18,146	5	0	3	130	19,548	5	0	3	140	19,796	5	0	3	141				
				BLC	14,424	2	0	2	103	15,539	2	0	3	111	15,736	2	0	3	112				
				LCCO	10,733	1	0	3	77	11,562	1	0	3	83	11,709	2	0	3	84				
				RCCO	10,733	1	0	3	77	11,562	1	0	3	83	11,709	2	0	3	84				
				80	700	P2	185W	T1S	22,305	3	0	3	121	24,029	3	0	3	130	24,333	3	0	3	132
								T2S	22,281	3	0	4	120	24,003	3	0	4	130	24,307	3	0	4	131
T2M	22,396	3	0					3	121	24,127	3	0	3	130	24,432	3	0	3	132				
T3S	21,690	3	0					4	117	23,366	3	0	4	126	23,662	3	0	4	128				
T3M	22,342	3	0					4	121	24,068	3	0	4	130	24,373	3	0	4	132				
T4M	21,857	3	0					4	118	23,545	3	0	4	127	23,844	3	0	4	129				
TFTM	22,328	3	0					4	121	24,054	3	0	4	130	24,358	3	0	4	132				
TSVS	23,222	5	0					1	126	25,016	5	0	1	135	25,333	5	0	1	137				
T5S	23,241	4	0					2	126	25,037	4	0	2	135	25,354	4	0	2	137				
T5M	23,182	5	0					3	125	24,974	5	0	3	135	25,290	5	0	3	137				
TSW	23,030	5	0					4	124	24,810	5	0	4	134	25,124	5	0	4	136				
BLC	18,307	2	0					3	99	19,721	2	0	3	107	19,971	2	0	3	108				
LCCO	13,622	2	0					3	74	14,674	2	0	4	79	14,860	2	0	4	80				
RCCO	13,622	2	0					3	74	14,674	2	0	4	79	14,860	2	0	4	80				
80	850	P3	217W					T1S	26,202	3	0	3	121	28,226	3	0	3	130	28,584	3	0	3	132
								T2S	26,174	3	0	4	121	28,196	3	0	4	130	28,553	3	0	4	132
				T2M	26,309	3	0	3	121	28,342	3	0	3	131	28,700	3	0	3	132				
				T3S	25,479	3	0	4	117	27,448	3	0	4	126	27,795	3	0	4	128				
				T3M	26,245	3	0	4	121	28,273	3	0	4	130	28,631	3	0	4	132				
				T4M	25,675	3	0	4	118	27,659	3	0	4	127	28,009	3	0	4	129				
				TFTM	26,229	3	0	4	121	28,255	3	0	4	130	28,613	3	0	4	132				
				TSVS	27,279	5	0	1	126	29,387	5	0	1	135	29,759	5	0	1	137				
				T5S	27,301	4	0	2	126	29,410	5	0	2	136	29,783	5	0	2	137				
				T5M	27,232	5	0	3	125	29,336	5	0	3	135	29,707	5	0	3	137				
				TSW	27,053	5	0	4	125	29,144	5	0	4	134	29,513	5	0	4	136				
				BLC	21,504	2	0	3	99	23,166	2	0	3	107	23,459	2	0	4	108				
				LCCO	16,001	2	0	4	74	17,238	2	0	4	79	17,456	2	0	4	80				
				RCCO	16,001	2	0	4	74	17,238	2	0	4	79	17,456	2	0	4	80				
				80	1050	P4	270W	T1S	30,963	4	0	4	115	33,355	4	0	4	124	33,777	4	0	4	125
								T2S	30,930	4	0	4	115	33,320	4	0	4	123	33,742	4	0	4	125
T2M	31,089	3	0					4	115	33,491	3	0	4	124	33,915	3	0	4	126				
T3S	30,108	4	0					4	112	32,435	4	0	5	120	32,845	4	0	5	122				
T3M	31,014	3	0					4	115	33,410	3	0	4	124	33,833	3	0	4	125				
T4M	30,340	3	0					5	112	32,684	3	0	5	121	33,098	3	0	5	123				
TFTM	30,995	3	0					5	115	33,390	3	0	5	124	33,812	3	0	5	125				
TSVS	32,235	5	0					1	119	34,726	5	0	1	129	35,166	5	0	1	130				
T5S	32,261	5	0					2	119	34,754	5	0	2	129	35,194	5	0	2	130				
T5M	32,180	5	0					4	119	34,667	5	0	4	128	35,105	5	0	4	130				
TSW	31,969	5	0					4	118	34,439	5	0	5	128	34,875	5	0	5	129				
BLC	25,412	2	0					4	94	27,376	2	0	4	101	27,722	2	0	4	103				
LCCO	18,909	2	0					4	70	20,370	2	0	4	75	20,628	2	0	4	76				
RCCO	18,909	2	0					4	70	20,370	2	0	4	75	20,628	2	0	4	76				

# Performance Data

## Lumen Output

Lumen values are from photometric tests performed in accordance with IESNA LM-79-08. Data is considered to be representative of the configurations shown, within the tolerances allowed by Lighting Facts. Contact factory for performance data on any configurations not shown here.

Forward Optics																			
LED Count	Drive Current	Power Package	System Watts	Dist. Type	30K (3000 K, 70 CRI)					40K (4000 K, 70 CRI)					50K (5000 K, 70 CRI)				
					Lumens	B	U	G	LPW	Lumens	B	U	G	LPW	Lumens	B	U	G	LPW
80	1250	P5	321W	T1S	35,193	4	0	4	110	37,912	4	0	4	118	38,392	4	0	4	120
				T2S	35,155	4	0	5	110	37,872	4	0	5	118	38,351	4	0	5	119
				T2M	35,336	4	0	4	110	38,067	4	0	4	119	38,549	4	0	4	120
				T3S	34,222	4	0	5	107	36,866	4	0	5	115	37,333	4	0	5	116
				T3M	35,251	3	0	4	110	37,974	3	0	5	118	38,455	4	0	5	120
				T4M	34,485	3	0	5	107	37,149	4	0	5	116	37,620	4	0	5	117
				TFTM	35,229	3	0	5	110	37,951	3	0	5	118	38,431	3	0	5	120
				TSVS	36,639	5	0	1	114	39,470	5	0	1	123	39,970	5	0	1	125
				T5S	36,669	5	0	2	114	39,502	5	0	2	123	40,002	5	0	2	125
				T5M	36,576	5	0	4	114	39,403	5	0	4	123	39,901	5	0	4	124
				TSW	36,336	5	0	5	113	39,144	5	0	5	122	39,640	5	0	5	123
				BLC	28,884	3	0	4	90	31,115	3	0	4	97	31,509	3	0	4	98
				LCCO	21,492	2	0	4	67	23,153	2	0	5	72	23,446	3	0	5	73
				RCCO	21,492	2	0	4	67	23,153	2	0	5	72	23,446	3	0	5	73
100	1050	P6	343W	T1S	37,824	4	0	4	110	40,747	4	0	4	119	41,263	4	0	4	120
				T2S	37,784	4	0	5	110	40,704	4	0	5	119	41,219	4	0	5	120
				T2M	37,979	4	0	4	111	40,913	4	0	4	119	41,431	4	0	4	121
				T3S	36,780	4	0	5	107	39,623	4	0	5	116	40,124	4	0	5	117
				T3M	37,886	3	0	5	110	40,814	4	0	5	119	41,331	4	0	5	120
				T4M	37,063	4	0	5	108	39,927	4	0	5	116	40,433	4	0	5	118
				TFTM	37,863	3	0	5	110	40,789	4	0	5	119	41,305	4	0	5	120
				TSVS	39,379	5	0	1	115	42,422	5	0	1	124	42,959	5	0	1	125
				T5S	39,411	5	0	2	115	42,456	5	0	2	124	42,993	5	0	2	125
				T5M	39,311	5	0	4	115	42,349	5	0	4	123	42,885	5	0	4	125
				TSW	39,053	5	0	5	114	42,071	5	0	5	123	42,604	5	0	5	124
				BLC	31,043	3	0	4	91	33,442	3	0	4	97	33,865	3	0	4	99
				LCCO	23,099	2	0	5	67	24,884	3	0	5	73	25,199	3	0	5	73
				RCCO	23,099	2	0	5	67	24,884	3	0	5	73	25,199	3	0	5	73
100	1250	P7	398W	T1S	42,599	4	0	4	107	45,890	4	0	4	115	46,471	4	0	4	117
				T2S	42,553	4	0	5	107	45,842	4	0	5	115	46,422	4	0	5	117
				T2M	42,773	4	0	4	107	46,078	4	0	4	116	46,661	4	0	5	117
				T3S	41,423	4	0	5	104	44,624	4	0	5	112	45,189	4	0	5	114
				T3M	42,669	4	0	5	107	45,966	4	0	5	115	46,548	4	0	5	117
				T4M	41,742	4	0	5	105	44,967	4	0	5	113	45,537	4	0	5	114
				TFTM	42,643	4	0	5	107	45,938	4	0	5	115	46,519	4	0	5	117
				TSVS	44,350	5	0	1	111	47,777	5	0	1	120	48,381	5	0	1	122
				T5S	44,385	5	0	2	112	47,815	5	0	3	120	48,420	5	0	3	122
				T5M	44,273	5	0	4	111	47,695	5	0	4	120	48,298	5	0	4	121
				TSW	43,983	5	0	5	111	47,382	5	0	5	119	47,982	5	0	5	121
				BLC	34,962	3	0	4	88	37,664	3	0	5	95	38,140	3	0	5	96
				LCCO	26,015	3	0	5	65	28,025	3	0	5	70	28,380	3	0	5	71
				RCCO	26,015	3	0	5	65	28,025	3	0	5	70	28,380	3	0	5	71
100	1350	P8	448W	T1S	45,610	4	0	4	106	49,135	4	0	4	114	49,757	4	0	4	115
				T2S	45,562	4	0	5	106	49,083	4	0	5	114	49,704	4	0	5	115
				T2M	45,797	4	0	4	106	49,336	4	0	5	114	49,960	4	0	5	116
				T3S	44,352	4	0	5	103	47,779	4	0	5	111	48,384	4	0	5	112
				T3M	45,686	4	0	5	106	49,216	4	0	5	114	49,839	4	0	5	116
				T4M	44,693	4	0	5	104	48,147	4	0	5	112	48,756	4	0	5	113
				TFTM	45,657	4	0	5	106	49,186	4	0	5	114	49,808	4	0	5	116
				TSVS	47,485	5	0	1	119	51,155	5	0	1	119	51,802	5	0	1	120
				T5S	47,524	5	0	3	110	51,196	5	0	3	119	51,844	5	0	3	120
				T5M	47,404	5	0	4	110	51,067	5	0	5	118	51,713	5	0	5	120
				TSW	47,093	5	0	5	109	50,732	5	0	5	118	51,374	5	0	5	119
				BLC	37,434	3	0	5	87	40,326	3	0	5	94	40,837	3	0	5	95
				LCCO	27,854	3	0	5	65	30,006	3	0	5	70	30,386	3	0	5	71
				RCCO	27,854	3	0	5	65	30,006	3	0	5	70	30,386	3	0	5	71





# Performance Data

## Lumen Output

Lumen values are from photometric tests performed in accordance with IESNA LM-79-08. Data is considered to be representative of the configurations shown, within the tolerances allowed by Lighting Facts. Contact factory for performance data on any configurations not shown here.

Rotated Optics																							
LED Count	Drive Current	Power Package	System Watts	Dist. Type	30K (3000 K, 70 CRI)					40K (4000 K, 70 CRI)					50K (5000 K, 70 CRI)								
					Lumens	B	U	G	LPW	Lumens	B	U	G	LPW	Lumens	B	U	G	LPW				
90	530	P10	156W	T1S	20,145	4	0	4	129	21,702	4	0	4	139	21,977	4	0	4	141				
				T2S	20,029	4	0	4	128	21,577	4	0	4	138	21,850	4	0	4	140				
				T2M	20,391	4	0	4	131	21,967	4	0	4	141	22,245	4	0	4	143				
				T3S	19,719	4	0	4	126	21,242	4	0	4	136	21,511	4	0	4	138				
				T3M	20,379	4	0	4	131	21,954	4	0	4	141	22,232	4	0	4	143				
				T4M	19,995	4	0	4	128	21,540	4	0	4	138	21,812	5	0	5	140				
				TFTM	20,511	4	0	4	131	22,096	5	0	5	142	22,376	5	0	5	143				
				TSVS	20,655	4	0	1	132	22,251	4	0	1	143	22,533	4	0	1	144				
				T5S	20,482	4	0	2	131	22,064	4	0	2	141	22,343	4	0	2	143				
				T5M	20,477	5	0	3	131	22,059	5	0	3	141	22,338	5	0	3	143				
				TSW	20,293	5	0	3	130	21,861	5	0	3	140	22,138	5	0	4	142				
				BLC	16,846	4	0	4	108	18,148	4	0	4	116	18,378	4	0	4	118				
				LCCO	12,032	2	0	3	77	12,961	2	0	3	83	13,125	2	0	3	84				
				RCCO	12,016	4	0	4	77	12,944	4	0	4	83	13,108	4	0	4	84				
				90	700	P11	207W	T1S	25,518	4	0	4	123	27,490	4	0	4	133	27,837	4	0	4	134
								T2S	25,371	5	0	5	123	27,331	5	0	5	132	27,677	5	0	5	134
T2M	25,829	4	0					4	125	27,825	4	0	4	134	28,177	4	0	4	136				
T3S	24,977	5	0					5	121	26,907	5	0	5	130	27,248	5	0	5	132				
T3M	25,814	5	0					5	125	27,809	5	0	5	134	28,161	5	0	5	136				
T4M	25,327	5	0					5	122	27,284	5	0	5	132	27,629	5	0	5	133				
TFTM	25,981	5	0					5	126	27,989	5	0	5	135	28,343	5	0	5	137				
TSVS	26,164	5	0					1	126	28,185	5	0	1	136	28,542	5	0	1	138				
T5S	25,943	4	0					2	125	27,948	5	0	2	135	28,302	5	0	2	137				
T5M	25,937	5	0					3	125	27,941	5	0	3	135	28,295	5	0	3	137				
TSW	25,704	5	0					4	124	27,691	5	0	4	134	28,041	5	0	4	135				
BLC	21,339	4	0					4	103	22,988	4	0	4	111	23,279	4	0	4	112				
LCCO	15,240	2	0					4	74	16,418	2	0	4	79	16,626	2	0	4	80				
RCCO	15,220	5	0					5	74	16,396	5	0	5	79	16,604	5	0	5	80				
90	850	P12	254W					T1S	29,912	4	0	4	118	32,223	4	0	4	127	32,631	5	0	4	128
								T2S	29,740	5	0	5	117	32,038	5	0	5	126	32,443	5	0	5	128
				T2M	30,277	4	0	4	119	32,616	5	0	5	128	33,029	5	0	5	130				
				T3S	29,278	5	0	5	115	31,540	5	0	5	124	31,940	5	0	5	126				
				T3M	30,259	5	0	5	119	32,597	5	0	5	128	33,010	5	0	5	130				
				T4M	29,688	5	0	5	117	31,982	5	0	5	126	32,387	5	0	5	128				
				TFTM	30,455	5	0	5	120	32,808	5	0	5	129	33,224	5	0	5	131				
				TSVS	30,669	5	0	1	121	33,039	5	0	1	130	33,457	5	0	1	132				
				T5S	30,411	5	0	2	120	32,761	5	0	2	129	33,176	5	0	2	131				
				T5M	30,404	5	0	3	120	32,753	5	0	4	129	33,168	5	0	4	131				
				TSW	30,131	5	0	4	119	32,459	5	0	4	128	32,870	5	0	4	129				
				BLC	25,013	4	0	4	98	26,946	4	0	4	106	27,287	4	0	4	107				
				LCCO	17,865	2	0	4	70	19,245	2	0	4	76	19,489	2	0	4	77				
				RCCO	17,841	5	0	5	70	19,220	5	0	5	76	19,463	5	0	5	77				
				90	1200	P13	344W	T1S	38,768	5	0	5	113	41,764	5	0	5	121	42,292	5	0	5	123
								T2S	38,545	5	0	5	112	41,523	5	0	5	121	42,049	5	0	5	122
T2M	39,241	5	0					5	114	42,273	5	0	5	123	42,808	5	0	5	124				
T3S	37,947	5	0					5	110	40,879	5	0	5	119	41,396	5	0	5	120				
T3M	39,218	5	0					5	114	42,249	5	0	5	123	42,783	5	0	5	124				
T4M	38,478	5	0					5	112	41,451	5	0	5	120	41,976	5	0	5	122				
TFTM	39,472	5	0					5	115	42,522	5	0	5	124	43,060	5	0	5	125				
TSVS	39,749	5	0					1	116	42,821	5	0	1	124	43,363	5	0	1	126				
T5S	39,415	5	0					2	115	42,461	5	0	2	123	42,998	5	0	2	125				
T5M	39,405	5	0					4	115	42,450	5	0	4	123	42,988	5	0	4	125				
TSW	39,052	5	0					5	114	42,069	5	0	5	122	42,602	5	0	5	124				
BLC	32,419	5	0					5	94	34,925	5	0	5	102	35,367	5	0	5	103				
LCCO	23,154	3	0					5	67	24,943	3	0	5	73	25,259	3	0	5	73				
RCCO	23,124	5	0					5	67	24,910	5	0	5	72	25,226	5	0	5	73				
90	1400	P14	405W					T1S	42,867	5	0	5	106	46,180	5	0	5	114	46,764	5	0	5	115
								T2S	42,621	5	0	5	105	45,914	5	0	5	113	46,495	5	0	5	115
				T2M	43,390	5	0	5	107	46,743	5	0	5	115	47,335	5	0	5	117				
				T3S	41,959	5	0	5	104	45,201	5	0	5	112	45,773	5	0	5	113				
				T3M	43,365	5	0	5	107	46,716	5	0	5	115	47,307	5	0	5	117				
				T4M	42,547	5	0	5	105	45,834	5	0	5	113	46,414	5	0	5	115				
				TFTM	43,646	5	0	5	108	47,018	5	0	5	116	47,614	5	0	5	118				
				TSVS	43,952	5	0	1	109	47,349	5	0	1	117	47,948	5	0	1	118				
				T5S	43,583	5	0	2	108	46,950	5	0	2	116	47,545	5	0	3	117				
				T5M	43,572	5	0	4	108	46,939	5	0	4	116	47,533	5	0	4	117				
				TSW	43,181	5	0	5	107	46,518	5	0	5	115	47,107	5	0	5	116				
				BLC	35,847	5	0	5	89	38,617	5	0	5	95	39,106	5	0	5	97				
				LCCO	25,602	3	0	5	63	27,580	3	0	5	68	27,930	3	0	5	69				
				RCCO	25,569	5	0	5	63	27,544	5	0	5	68	27,893	5	0	5	69				

## Capable Luminaire

This item is an A+ capable luminaire, which has been designed and tested to provide consistent color appearance and system-level interoperability.

- All configurations of this luminaire meet the Acuity Brands' specification for chromatic consistency
- This luminaire is A+ Certified when ordered with DTL® controls marked by a [shaded background](#). DTL DLL equipped luminaires meet the A+ specification for luminaire to photocontrol interoperability<sup>1</sup>
- This luminaire is part of an A+ Certified solution for ROAM® or XPoint™ Wireless control networks, providing out-of-the-box control compatibility with simple commissioning, when ordered with drivers and control options marked by a [shaded background](#)<sup>1</sup>

To learn more about A+, visit [www.acuitybrands.com/aplus](http://www.acuitybrands.com/aplus).

1. See ordering tree for details.
2. A+ Certified Solutions for ROAM require the order of one ROAM node per luminaire.  
Sold Separately: [Link to Roam](#); [Link to DTL DLL](#)

### FEATURES & SPECIFICATIONS

#### INTENDED USE

The sleek design of the D-Series Area Size 2 reflects the embedded high performance LED technology. It is ideal for applications like car dealerships and large parking lots adjacent to malls, transit stations, grocery stores, home centers, and other big-box retailers.

#### CONSTRUCTION

Single-piece die-cast aluminum housing has integral heat sink fins to optimize thermal management through conductive and convective cooling. Modular design allows for ease of maintenance and future light engine upgrades. The LED drivers are mounted in direct contact with the casting to promote low operating temperature and long life. Housing is completely sealed against moisture and environmental contaminants (IP65). Low EPA (1.1 ft<sup>2</sup>) for optimized pole wind loading.

#### FINISH

Exterior parts are protected by a zinc-infused Super Durable TGIC thermoset powder coat finish that provides superior resistance to corrosion and weathering. A tightly controlled multi-stage process ensures a minimum 3 mils thickness for a finish that can withstand extreme climate changes without cracking or peeling. Available in both textured and non-textured finishes.

#### OPTICS

Precision-molded proprietary acrylic lenses are engineered for superior area lighting distribution, uniformity, and pole spacing. Light engines are available in 3000 K, 4000 K, or 5000 K (70 CRI) configurations. The D-Series Size 2 has zero uplight and qualifies as a Nighttime Friendly™ product, meaning it is consistent with the LEED® and Green Globes™ criteria for eliminating wasteful uplight.

#### ELECTRICAL

Light engine configurations consist of high-efficacy LEDs mounted to metal-core circuit boards to maximize heat dissipation and promote long life (up to L85/100,000 hrs at 25°C). Class 1 electronic drivers are designed to have a power factor >90%, THD <20%, and an expected life of 100,000 hours with <1% failure rate. Easily-serviceable 10kV surge protection device meets a minimum Category C Low operation (per ANSI/IEEE C62.41.2).

#### INSTALLATION

Included mounting block and integral arm facilitate quick and easy installation. Stainless steel bolts fasten the mounting block securely to poles and walls, enabling the D-Series Size 2 to withstand up to a 2.0 G vibration load rating per ANSI C136.31. The D-Series Size 2 utilizes the AERIS™ series pole drilling pattern (Template #8). NEMA photocontrol receptacle is available.

#### STANDARD CONTROLS

The DSX2 LED area luminaire has a number of control options. Dusk to dawn controls can be utilized via optional NEMA twist-lock photocell receptacles. Integrated motion sensors with on-board photocells feature field-adjustable programming and are suitable for mounting heights up to 30 feet.

#### nLIGHT AIR CONTROLS

The DSX2 LED area luminaire is also available with nLight® AIR for the ultimate in wireless control. This powerful controls platform provides out-of-the-box basic motion sensing and photocontrol functionality and is suitable for mounting heights up to 40 feet. Once commissioned using a smartphone and the easy-to-use CLAIRITY app, nLight AIR equipped luminaires can be grouped, resulting in motion sensor and photocell group response without the need for additional equipment. Scheduled dimming with motion sensor override can be achieved when used with the nLight Eclipse. Additional information about nLight Air can be found [here](#).

#### LISTINGS

UL Listed for wet locations. Light engines are IP66 rated; luminaire is IP65 rated. Rated for -40°C minimum ambient. U.S. Patent No. D670,857 S. International patent pending.

DesignLights Consortium® (DLC) Premium qualified product and DLC qualified product. Not all versions of this product may be DLC Premium qualified or DLC qualified. Please check the DLC Qualified Products List at [www.designlights.org/QPL](http://www.designlights.org/QPL) to confirm which versions are qualified.

International Dark-Sky Association (IDA) Fixture Seal of Approval (FSA) is available for all products on this page utilizing 3000K color temperature only.

#### WARRANTY

5-year limited warranty. Complete warranty terms located at: [www.acuitybrands.com/support/customer-support/terms-and-conditions](http://www.acuitybrands.com/support/customer-support/terms-and-conditions)

**Note:** Actual performance may differ as a result of end-user environment and application.

All values are design or typical values, measured under laboratory conditions at 25 °C.

Specifications subject to change without notice.



d<sup>2</sup>series

# D-Series Size 2 LED Area Luminaire



## Specifications

<b>EPA:</b>	1.1 ft <sup>2</sup> (0.10 m <sup>2</sup> )
<b>Length:</b>	40" (101.6 cm)
<b>Width:</b>	15" (38.1 cm)
<b>Height 1:</b>	7-1/4" (18.4 cm)
<b>Height 2: (max):</b>	3.5"
<b>Weight:</b>	36lbs

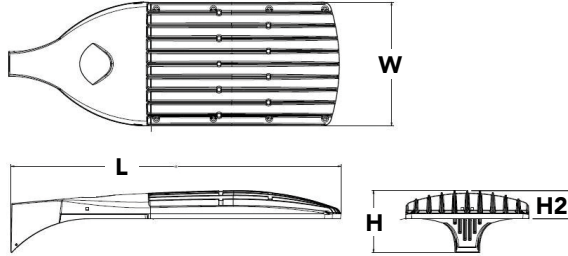

Catalog  
Number

Notes

Type

Hit the Tab key or mouse over the page to see all interactive elements.

## Introduction

The modern styling of the D-Series is striking yet unobtrusive - making a bold, progressive statement even as it blends seamlessly with its environment.

The D-Series distills the benefits of the latest in LED technology into a high performance, high efficacy, long-life luminaire. The outstanding photometric performance results in sites with excellent uniformity, greater pole spacing and lower power density. The Size 2 is ideal for replacing 400-1000W metal halide in area lighting applications with energy savings of up to 80% and expected service life of over 100,000 hours.

A+ Capable options indicated by this color background.

## Ordering Information

**EXAMPLE:** DSX2 LED P7 40K T3M MVOLT SPA NLTAIR2 PIRHN DDBXD

DSX2 LED		Color temperature		Distribution		Voltage	Mounting		
Series	LEDs	30K	3000 K	T1S	Type I Short (Automotive)	T5VS	Type V Very Short <sup>2</sup>	Shipped included	
DSX2 LED	<b>Forward optics</b>	40K	4000 K	T2S	Type II Short	T5M	Type V Medium <sup>2</sup>		SPA Square pole mounting RPA Round pole mounting WBA Wall bracket <sup>2</sup> SPUMBA Square pole universal mounting adaptor <sup>6</sup> RPUMBA Round pole universal mounting adaptor <sup>6</sup> <b>Shipped separately</b> KMA8 DDBXD U Mast arm mounting bracket adaptor (specify finish) <sup>7</sup>
	P1 P5	50K	5000 K	T2M	Type II Medium	T5W	Type V Wide <sup>2</sup>		
	P2 P6			T3S	Type III Short	BLC	Backlight control <sup>3</sup>		
	P3 P7			T3M	Type III Medium	LCCO	Left corner cutoff <sup>3</sup>		
	P4 P8			T4M	Type IV Medium	RCCO	Right corner cutoff <sup>3</sup>		
	<b>Rotated optics<sup>1</sup></b>			TFTM	Forward Throw Medium				
	P10 P13					MVOLT <sup>4</sup>	120 <sup>5</sup>		
	P11 P14					208 <sup>5</sup>	240 <sup>5</sup>		
	P12					277 <sup>5</sup>	347 <sup>5</sup>		
							480 <sup>5</sup>		

Control options	Other options	Finish (required)
<b>Shipped installed</b> NLTAIR2 nLight AIR generation 2 enabled <sup>8</sup> PIRHN Network, Bi-Level motion/ambient sensor <sup>9</sup> PER NEMA twist-lock receptacle only (no controls) <sup>10</sup> PER5 Five-wire receptacle only (no controls) <sup>10,11</sup> PER7 Seven-wire receptacle only (no controls) <sup>10,11</sup> DMG 0-10V dimming extend out back of housing for external control (no controls) <sup>12</sup> DS Dual switching <sup>13,14</sup>	<b>Shipped installed</b> HS House-side shield <sup>16</sup> SF Single fuse (120, 277, 347V) <sup>5</sup> DF Double fuse (208, 240, 480V) <sup>5</sup> L90 Left rotated optics <sup>1</sup> R90 Right rotated optics <sup>1</sup> <b>Shipped separately</b> BS Bird spikes <sup>17</sup> EGS External glare shield	DDBXD Dark bronze DBLXD Black DNAXD Natural aluminum DWHXD White DDBTXD Textured dark bronze DBLBXD Textured black DNATXD Textured natural aluminum DWHGXD Textured white
PIRH Bi-level, motion/ambient sensor, 15-30' mounting height, ambient sensor enable at 5fc FAO Field Adjustable Output <sup>15</sup>		



One Lithonia Way • Conyers, Georgia 30012 • Phone: 1-800-705-SERV (7378) • [www.lithonia.com](http://www.lithonia.com)  
 © 2011-2020 Acuity Brands Lighting, Inc. All rights reserved.

DSX2-LED  
 Rev. 02/05/20  
 Page 1 of 8

## Ordering Information

### Accessories

Ordered and shipped separately.

DLL127F 1.5 JU	Photocell - SSL twist-lock (120-277V) <sup>18</sup>
DLL347F 1.5 CUL JU	Photocell - SSL twist-lock (347V) <sup>18</sup>
DLL480F 1.5 CUL JU	Photocell - SSL twist-lock (480V) <sup>18</sup>
DSHORT SBK U	Shorting cap <sup>18</sup>
DSX2HS 80C U	House-side shield for 80 LED unit <sup>19</sup>
DSX2HS 90C U	House-side shield for 90 LED unit <sup>19</sup>
DSX2HS 100C U	House-side shield for 100 LED unit <sup>19</sup>
PUMBA DDBXD U*	Square and round pole universal mounting bracket (specify finish) <sup>20</sup>
KMA8 DDBXD U	Mast arm mounting bracket adaptor (specify finish) <sup>4</sup>
DSX2EGS (FINISH) U	External glare shield

For more control options, visit [DTL](#) and [ROAM](#) online.

### NOTES

- P10, P11, P12, P13 or P14 and rotated optics (L90, R90) only available together.
- Any Type 5 distribution with photocell, is not available with WBA.
- Not available with HS.
- MVOLT driver operates on any line voltage from 120-277V (50/60 Hz).
- Single fuse (SF) requires 120V, 277V or 347V. Double fuse (DF) requires 208V, 240V or 480V.
- Universal mounting bracket intended for retrofit on existing pre-drilled poles only. 1.5 G vibration load rating per ANCI C136.31.
- Must order fixture with SPA option. Must be ordered as a separate accessory; see Accessories information. For use with 2-3/8" mast arm (not included).
- Must be ordered with PIRHN. Sensor cover only available in dark bronze, black, white or natural aluminum color.
- Must be ordered with NLTAIR2. For more information on nLight Air 2 visit [this link](#).
- Photocell ordered and shipped as a separate line item from Acuity Brands Controls. See accessories. Not available with DS option. Shorting Cap included.
- If ROAM® node required, it must be ordered and shipped as a separate line item from Acuity Brands Controls. Node with integral dimming.
- DMG not available with PIRHN, PER5, PER7, PIR, PIRH, PIR1FC3V or PIRH1FC3V.
- Requires (2) separately switched circuits with isolated neutrals. See Outdoor Control Technical Guide for details.
- Provides 50/50 fixture operation via (2) independent drivers. Not available with PER, PER5, PER7, PIR or PIRH. Not available with P1, P2, P10.
- Reference controls options table on page 4.
- Not available with BLC, LCCO and RCCO distribution. Also available as a separate accessories; see Accessories information.
- Must be ordered with fixture for factory pre-drilling.
- Requires luminaire to be specified with PER, PER5 and PER7 option. Ordered and shipped as a separate line item from Acuity Brands Controls.
- Not available with other dimming controls options.
- For retrofit use only.

## Options

### EGS - External Glare Shield

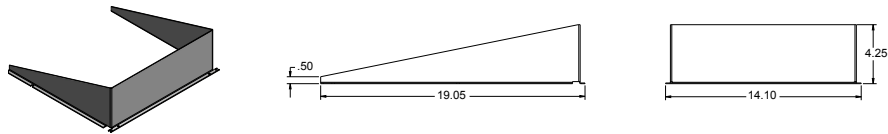

## Drilling

### HANDHOLE ORIENTATION

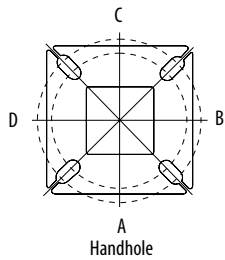

### Tenon Mounting Slipfitter\*\*

Tenon O.D.	Mounting	Single Unit	2 @ 180	2 @ 90	3 @ 120	3 @ 90	4 @ 90
2-3/8"	SPA/RPA	AS3-5 190	AS3-5 280	AS3-5 290	AS3-5 320	AS3-5 390	AS3-5 490
	SPUMBA	AS3-5 190	AS3-5 280	AS4-5 290	AS3-5 320	AS4-5 390	AS4-5 490
	RUPUMBA	AS3-5 190	AS3-5 280		AS3-5 320		
2-7/8"	SPA/RPA	AST25-190	AST25-280	AST25-290	AST25-320	AST25-390	AST25-490
	SPUMBA	AST25-190	AST25-280		AST25-320		
	RUPUMBA	AST25-190	AST25-280		AST25-320		
4"	SPA/RPA	AST35-190	AST35-280	AST35-290	AST35-320	AST35-390	AST35-490
	SPUMBA	AST35-190	AST35-280	AST35-290	AST35-320	AST35-390	AST35-490
	RUPUMBA	AST35-190	AST35-280		AST35-320		

Mounting Option	Drilling Template	Single	2 @ 180	2 @ 90	3 @ 90	3 @ 120	4 @ 90
Head Location		Side B	Side B & D	Side B & C	Side B, C & D	Round Pole Only	Side A, B, C & D
Drill Nomenclature	#8	DM19AS	DM28AS	DM29AS	DM39AS	DM32AS	DM49AS

	Drilling Template	Minimum Acceptable Outside Pole Dimension					
SPA	#8	2-7/8"	2-7/8"	3.5"	3.5"	3"	3.5"
RPA	#8	2-7/8"	2-7/8"	3.5"	3.5"	3"	3.5"
SPUMBA	#5	2-7/8"	3"	4"	4"	3.5"	4"
RPUMBA	#5	2-7/8"	3.5"	5"	5"	3.5"	5"

Template #8

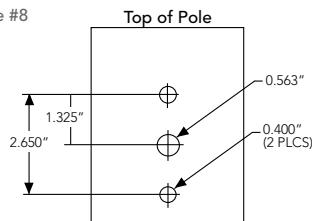

Isofootcandle plots for the DSX2 LED 80C 1000 40K. Distances are in units of mounting height (30').

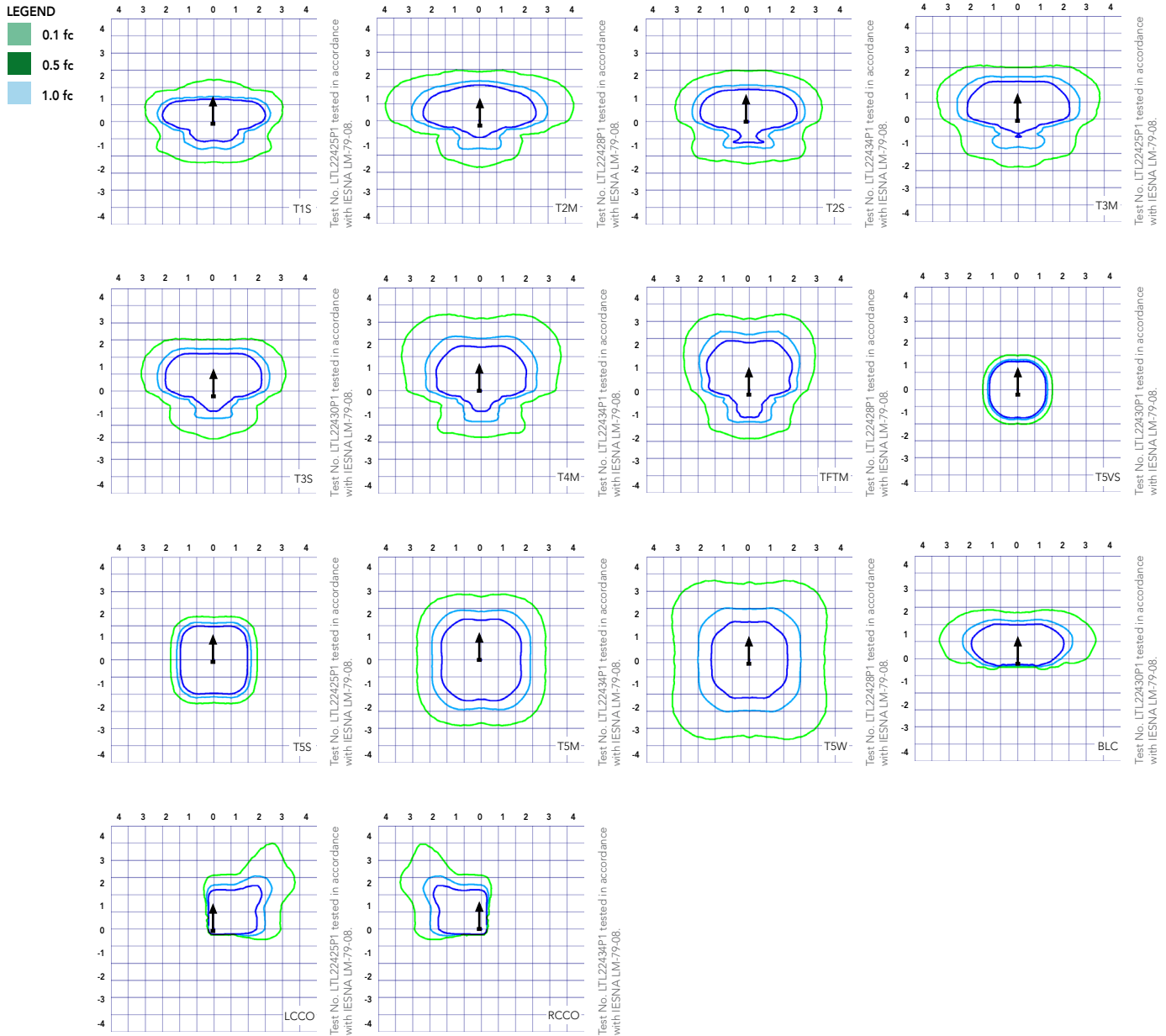

## Performance Data

### Lumen Ambient Temperature (LAT) Multipliers

Use these factors to determine relative lumen output for average ambient temperatures from 0-40°C (32-104°F).

Ambient		Lumen Multiplier
0°C	32°F	1.04
5°C	41°F	1.04
10°C	50°F	1.03
15°C	59°F	1.02
20°C	68°F	1.01
<b>25°C</b>	<b>77°F</b>	<b>1.00</b>
30°C	86°F	0.99
35°C	95°F	0.98
40°C	104°F	0.97

### Projected LED Lumen Maintenance

Data references the extrapolated performance projections for the platforms noted in a **25°C ambient**, based on 10,000 hours of LED testing (tested per IESNA LM-80-08 and projected per IESNA TM-21-11).

To calculate LLF, use the lumen maintenance factor that corresponds to the desired number of operating hours below. For other lumen maintenance values, contact factory.

Operating Hours	0	25000	50000	100000
Lumen Maintenance Factor	1.00	0.96	0.92	0.85

### Electrical Load

	Performance Package	LED Count	Drive Current	Wattage	Current (A)					
					120	208	240	277	347	480
Forward Optics (Non-Rotated)	P1	80	530	140	1.18	0.68	0.59	0.51	0.40	0.32
	P2	80	700	185	1.56	0.90	0.78	0.66	0.52	0.39
	P3	80	850	217	1.82	1.05	0.90	0.80	0.63	0.48
	P4	80	1050	270	2.27	1.31	1.12	0.99	0.79	0.59
	P5	80	1250	321	2.68	1.54	1.34	1.17	0.93	0.68
	P6	100	1050	343	2.89	1.66	1.59	1.37	1.00	0.71
	P7	100	1250	398	3.31	1.91	1.66	1.45	1.16	0.81
	P8	100	1350	431	3.61	2.07	1.81	1.57	1.25	0.91
Rotated Optics (Requires L90 or R90)	P10	90	530	156	1.30	0.76	0.65	0.62	0.45	0.32
	P11	90	700	207	1.75	1.01	0.87	0.74	0.60	0.46
	P12	90	850	254	2.12	1.22	1.06	0.94	0.73	0.55
	P13	90	1200	344	2.88	1.65	1.44	1.25	1.00	0.73
	P14	90	1400	405	3.39	1.95	1.71	1.48	1.18	0.86

Motion Sensor Default Settings						
Option	Dimmed State	High Level (when triggered)	Photocell Operation	Dwell Time	Ramp-up Time	Ramp-down Time
PIR or PIRH	3V (37%) Output	10V (100%) Output	Enabled @ 5FC	5 min	3 sec	5 min
*PIR1FC3V or PIRH1FC3V	3V (37%) Output	10V (100%) Output	Enabled @ 1FC	5 min	3 sec	5 min

\*for use when motion sensor is used as dusk to dawn control.

Controls Options				
Nomenclature	Description	Functionality	Primary control device	Notes
FAO	Field adjustable output device installed inside the luminaire; wired to the driver dimming leads.	Allows the luminaire to be manually dimmed, effectively trimming the light output.	FAO device	Cannot be used with other controls options that need the 0-10V leads
DS	Drivers wired independently for 50/50 luminaire operation	The luminaire is wired to two separate circuits, allowing for 50/50 operation.	Independently wired drivers	Requires two separately switched circuits. Consider nLight AIR as a more cost effective alternative.
PERS or PER7	Twist-lock photocell receptical	Compatible with standard twist-lock photocells for dusk to dawn operation, or advanced control nodes that provide 0-10V dimming signals.	Twist-lock photocells such as DLL Elite or advanced control nodes such as ROAM.	Pins 4 & 5 to dimming leads on driver, Pins 6 & 7 are capped inside luminaire
PIR or PIRH	Motion sensors with integral photocell. PIR for 8-15' mounting; PIRH for 15-30' mounting	Luminaires dim when no occupancy is detected.	Acuity Controls SBGR	Also available with PIRH1FC3V when the sensor photocell is used for dusk-to-dawn operation.
NLTAIR2 PIRHN	nLight AIR enabled luminaire for motion sensing, photocell and wireless communication.	Motion and ambient light sensing with group response. Scheduled dimming with motion sensor over-ride when wirelessly connected to the nLight Eclipse.	nLight Air rSBGR	nLight AIR sensors can be programmed and commissioned from the ground using the CIAIRity Pro app.

# Performance Data

## Lumen Output

Lumen values are from photometric tests performed in accordance with IESNA LM-79-08. Data is considered to be representative of the configurations shown, within the tolerances allowed by Lighting Facts. Contact factory for performance data on any configurations not shown here.

Forward Optics																							
LED Count	Drive Current	Power Package	System Watts	Dist. Type	30K (3000 K, 70 CRI)					40K (4000 K, 70 CRI)					50K (5000 K, 70 CRI)								
					Lumens	B	U	G	LPW	Lumens	B	U	G	LPW	Lumens	B	U	G	LPW				
80	530	P1	140W	T1S	17,575	3	0	3	126	18,933	3	0	3	135	19,173	3	0	3	137				
				T2S	17,556	3	0	3	125	18,913	3	0	3	135	19,152	3	0	3	137				
				T2M	17,647	3	0	3	126	19,010	3	0	3	136	19,251	3	0	3	138				
				T3S	17,090	3	0	3	122	18,411	3	0	3	132	18,644	3	0	3	133				
				T3M	17,604	3	0	3	126	18,964	3	0	3	135	19,204	3	0	3	137				
				T4M	17,221	3	0	3	123	18,552	3	0	4	133	18,787	3	0	4	134				
				TFTM	17,593	3	0	3	126	18,952	3	0	4	135	19,192	3	0	4	137				
				TSVS	18,297	4	0	1	131	19,711	4	0	1	141	19,961	4	0	1	143				
				T5S	18,312	4	0	2	131	19,727	4	0	2	141	19,977	4	0	2	143				
				T5M	18,266	4	0	2	130	19,677	4	0	2	141	19,926	4	0	2	142				
				TSW	18,146	5	0	3	130	19,548	5	0	3	140	19,796	5	0	3	141				
				BLC	14,424	2	0	2	103	15,539	2	0	3	111	15,736	2	0	3	112				
				LCCO	10,733	1	0	3	77	11,562	1	0	3	83	11,709	2	0	3	84				
				RCCO	10,733	1	0	3	77	11,562	1	0	3	83	11,709	2	0	3	84				
				80	700	P2	185W	T1S	22,305	3	0	3	121	24,029	3	0	3	130	24,333	3	0	3	132
								T2S	22,281	3	0	4	120	24,003	3	0	4	130	24,307	3	0	4	131
T2M	22,396	3	0					3	121	24,127	3	0	3	130	24,432	3	0	3	132				
T3S	21,690	3	0					4	117	23,366	3	0	4	126	23,662	3	0	4	128				
T3M	22,342	3	0					4	121	24,068	3	0	4	130	24,373	3	0	4	132				
T4M	21,857	3	0					4	118	23,545	3	0	4	127	23,844	3	0	4	129				
TFTM	22,328	3	0					4	121	24,054	3	0	4	130	24,358	3	0	4	132				
TSVS	23,222	5	0					1	126	25,016	5	0	1	135	25,333	5	0	1	137				
T5S	23,241	4	0					2	126	25,037	4	0	2	135	25,354	4	0	2	137				
T5M	23,182	5	0					3	125	24,974	5	0	3	135	25,290	5	0	3	137				
TSW	23,030	5	0					4	124	24,810	5	0	4	134	25,124	5	0	4	136				
BLC	18,307	2	0					3	99	19,721	2	0	3	107	19,971	2	0	3	108				
LCCO	13,622	2	0					3	74	14,674	2	0	4	79	14,860	2	0	4	80				
RCCO	13,622	2	0					3	74	14,674	2	0	4	79	14,860	2	0	4	80				
80	850	P3	217W					T1S	26,202	3	0	3	121	28,226	3	0	3	130	28,584	3	0	3	132
								T2S	26,174	3	0	4	121	28,196	3	0	4	130	28,553	3	0	4	132
				T2M	26,309	3	0	3	121	28,342	3	0	3	131	28,700	3	0	3	132				
				T3S	25,479	3	0	4	117	27,448	3	0	4	126	27,795	3	0	4	128				
				T3M	26,245	3	0	4	121	28,273	3	0	4	130	28,631	3	0	4	132				
				T4M	25,675	3	0	4	118	27,659	3	0	4	127	28,009	3	0	4	129				
				TFTM	26,229	3	0	4	121	28,255	3	0	4	130	28,613	3	0	4	132				
				TSVS	27,279	5	0	1	126	29,387	5	0	1	135	29,759	5	0	1	137				
				T5S	27,301	4	0	2	126	29,410	5	0	2	136	29,783	5	0	2	137				
				T5M	27,232	5	0	3	125	29,336	5	0	3	135	29,707	5	0	3	137				
				TSW	27,053	5	0	4	125	29,144	5	0	4	134	29,513	5	0	4	136				
				BLC	21,504	2	0	3	99	23,166	2	0	3	107	23,459	2	0	4	108				
				LCCO	16,001	2	0	4	74	17,238	2	0	4	79	17,456	2	0	4	80				
				RCCO	16,001	2	0	4	74	17,238	2	0	4	79	17,456	2	0	4	80				
				80	1050	P4	270W	T1S	30,963	4	0	4	115	33,355	4	0	4	124	33,777	4	0	4	125
								T2S	30,930	4	0	4	115	33,320	4	0	4	123	33,742	4	0	4	125
T2M	31,089	3	0					4	115	33,491	3	0	4	124	33,915	3	0	4	126				
T3S	30,108	4	0					4	112	32,435	4	0	5	120	32,845	4	0	5	122				
T3M	31,014	3	0					4	115	33,410	3	0	4	124	33,833	3	0	4	125				
T4M	30,340	3	0					5	112	32,684	3	0	5	121	33,098	3	0	5	123				
TFTM	30,995	3	0					5	115	33,390	3	0	5	124	33,812	3	0	5	125				
TSVS	32,235	5	0					1	119	34,726	5	0	1	129	35,166	5	0	1	130				
T5S	32,261	5	0					2	119	34,754	5	0	2	129	35,194	5	0	2	130				
T5M	32,180	5	0					4	119	34,667	5	0	4	128	35,105	5	0	4	130				
TSW	31,969	5	0					4	118	34,439	5	0	5	128	34,875	5	0	5	129				
BLC	25,412	2	0					4	94	27,376	2	0	4	101	27,722	2	0	4	103				
LCCO	18,909	2	0					4	70	20,370	2	0	4	75	20,628	2	0	4	76				
RCCO	18,909	2	0					4	70	20,370	2	0	4	75	20,628	2	0	4	76				

# Performance Data

## Lumen Output

Lumen values are from photometric tests performed in accordance with IESNA LM-79-08. Data is considered to be representative of the configurations shown, within the tolerances allowed by Lighting Facts. Contact factory for performance data on any configurations not shown here.

Forward Optics																			
LED Count	Drive Current	Power Package	System Watts	Dist. Type	30K (3000 K, 70 CRI)					40K (4000 K, 70 CRI)					50K (5000 K, 70 CRI)				
					Lumens	B	U	G	LPW	Lumens	B	U	G	LPW	Lumens	B	U	G	LPW
80	1250	P5	321W	T1S	35,193	4	0	4	110	37,912	4	0	4	118	38,392	4	0	4	120
				T2S	35,155	4	0	5	110	37,872	4	0	5	118	38,351	4	0	5	119
				T2M	35,336	4	0	4	110	38,067	4	0	4	119	38,549	4	0	4	120
				T3S	34,222	4	0	5	107	36,866	4	0	5	115	37,333	4	0	5	116
				T3M	35,251	3	0	4	110	37,974	3	0	5	118	38,455	4	0	5	120
				T4M	34,485	3	0	5	107	37,149	4	0	5	116	37,620	4	0	5	117
				TFTM	35,229	3	0	5	110	37,951	3	0	5	118	38,431	3	0	5	120
				TSVS	36,639	5	0	1	114	39,470	5	0	1	123	39,970	5	0	1	125
				T5S	36,669	5	0	2	114	39,502	5	0	2	123	40,002	5	0	2	125
				T5M	36,576	5	0	4	114	39,403	5	0	4	123	39,901	5	0	4	124
				TSW	36,336	5	0	5	113	39,144	5	0	5	122	39,640	5	0	5	123
				BLC	28,884	3	0	4	90	31,115	3	0	4	97	31,509	3	0	4	98
				LCCO	21,492	2	0	4	67	23,153	2	0	5	72	23,446	3	0	5	73
				RCCO	21,492	2	0	4	67	23,153	2	0	5	72	23,446	3	0	5	73
100	1050	P6	343W	T1S	37,824	4	0	4	110	40,747	4	0	4	119	41,263	4	0	4	120
				T2S	37,784	4	0	5	110	40,704	4	0	5	119	41,219	4	0	5	120
				T2M	37,979	4	0	4	111	40,913	4	0	4	119	41,431	4	0	4	121
				T3S	36,780	4	0	5	107	39,623	4	0	5	116	40,124	4	0	5	117
				T3M	37,886	3	0	5	110	40,814	4	0	5	119	41,331	4	0	5	120
				T4M	37,063	4	0	5	108	39,927	4	0	5	116	40,433	4	0	5	118
				TFTM	37,863	3	0	5	110	40,789	4	0	5	119	41,305	4	0	5	120
				TSVS	39,379	5	0	1	115	42,422	5	0	1	124	42,959	5	0	1	125
				T5S	39,411	5	0	2	115	42,456	5	0	2	124	42,993	5	0	2	125
				T5M	39,311	5	0	4	115	42,349	5	0	4	123	42,885	5	0	4	125
				TSW	39,053	5	0	5	114	42,071	5	0	5	123	42,604	5	0	5	124
				BLC	31,043	3	0	4	91	33,442	3	0	4	97	33,865	3	0	4	99
				LCCO	23,099	2	0	5	67	24,884	3	0	5	73	25,199	3	0	5	73
				RCCO	23,099	2	0	5	67	24,884	3	0	5	73	25,199	3	0	5	73
100	1250	P7	398W	T1S	42,599	4	0	4	107	45,890	4	0	4	115	46,471	4	0	4	117
				T2S	42,553	4	0	5	107	45,842	4	0	5	115	46,422	4	0	5	117
				T2M	42,773	4	0	4	107	46,078	4	0	4	116	46,661	4	0	5	117
				T3S	41,423	4	0	5	104	44,624	4	0	5	112	45,189	4	0	5	114
				T3M	42,669	4	0	5	107	45,966	4	0	5	115	46,548	4	0	5	117
				T4M	41,742	4	0	5	105	44,967	4	0	5	113	45,537	4	0	5	114
				TFTM	42,643	4	0	5	107	45,938	4	0	5	115	46,519	4	0	5	117
				TSVS	44,350	5	0	1	111	47,777	5	0	1	120	48,381	5	0	1	122
				T5S	44,385	5	0	2	112	47,815	5	0	3	120	48,420	5	0	3	122
				T5M	44,273	5	0	4	111	47,695	5	0	4	120	48,298	5	0	4	121
				TSW	43,983	5	0	5	111	47,382	5	0	5	119	47,982	5	0	5	121
				BLC	34,962	3	0	4	88	37,664	3	0	5	95	38,140	3	0	5	96
				LCCO	26,015	3	0	5	65	28,025	3	0	5	70	28,380	3	0	5	71
				RCCO	26,015	3	0	5	65	28,025	3	0	5	70	28,380	3	0	5	71
100	1350	P8	448W	T1S	45,610	4	0	4	106	49,135	4	0	4	114	49,757	4	0	4	115
				T2S	45,562	4	0	5	106	49,083	4	0	5	114	49,704	4	0	5	115
				T2M	45,797	4	0	4	106	49,336	4	0	5	114	49,960	4	0	5	116
				T3S	44,352	4	0	5	103	47,779	4	0	5	111	48,384	4	0	5	112
				T3M	45,686	4	0	5	106	49,216	4	0	5	114	49,839	4	0	5	116
				T4M	44,693	4	0	5	104	48,147	4	0	5	112	48,756	4	0	5	113
				TFTM	45,657	4	0	5	106	49,186	4	0	5	114	49,808	4	0	5	116
				TSVS	47,485	5	0	1	119	51,155	5	0	1	119	51,802	5	0	1	120
				T5S	47,524	5	0	3	110	51,196	5	0	3	119	51,844	5	0	3	120
				T5M	47,404	5	0	4	110	51,067	5	0	5	118	51,713	5	0	5	120
				TSW	47,093	5	0	5	109	50,732	5	0	5	118	51,374	5	0	5	119
				BLC	37,434	3	0	5	87	40,326	3	0	5	94	40,837	3	0	5	95
				LCCO	27,854	3	0	5	65	30,006	3	0	5	70	30,386	3	0	5	71
				RCCO	27,854	3	0	5	65	30,006	3	0	5	70	30,386	3	0	5	71





# Performance Data

## Lumen Output

Lumen values are from photometric tests performed in accordance with IESNA LM-79-08. Data is considered to be representative of the configurations shown, within the tolerances allowed by Lighting Facts. Contact factory for performance data on any configurations not shown here.

Rotated Optics																			
LED Count	Drive Current	Power Package	System Watts	Dist. Type	30K (3000 K, 70 CRI)					40K (4000 K, 70 CRI)					50K (5000 K, 70 CRI)				
					Lumens	B	U	G	LPW	Lumens	B	U	G	LPW	Lumens	B	U	G	LPW
90	530	P10	156W	T1S	20,145	4	0	4	129	21,702	4	0	4	139	21,977	4	0	4	141
				T2S	20,029	4	0	4	128	21,577	4	0	4	138	21,850	4	0	4	140
				T2M	20,391	4	0	4	131	21,967	4	0	4	141	22,245	4	0	4	143
				T3S	19,719	4	0	4	126	21,242	4	0	4	136	21,511	4	0	4	138
				T3M	20,379	4	0	4	131	21,954	4	0	4	141	22,232	4	0	4	143
				T4M	19,995	4	0	4	128	21,540	4	0	4	138	21,812	5	0	5	140
				TFTM	20,511	4	0	4	131	22,096	5	0	5	142	22,376	5	0	5	143
				TSVS	20,655	4	0	1	132	22,251	4	0	1	143	22,533	4	0	1	144
				T5S	20,482	4	0	2	131	22,064	4	0	2	141	22,343	4	0	2	143
				T5M	20,477	5	0	3	131	22,059	5	0	3	141	22,338	5	0	3	143
				TSW	20,293	5	0	3	130	21,861	5	0	3	140	22,138	5	0	4	142
				BLC	16,846	4	0	4	108	18,148	4	0	4	116	18,378	4	0	4	118
				LCCO	12,032	2	0	3	77	12,961	2	0	3	83	13,125	2	0	3	84
				RCCO	12,016	4	0	4	77	12,944	4	0	4	83	13,108	4	0	4	84
				90	700	P11	207W	T1S	25,518	4	0	4	123	27,490	4	0	4	133	27,837
T2S	25,371	5	0					5	123	27,331	5	0	5	132	27,677	5	0	5	134
T2M	25,829	4	0					4	125	27,825	4	0	4	134	28,177	4	0	4	136
T3S	24,977	5	0					5	121	26,907	5	0	5	130	27,248	5	0	5	132
T3M	25,814	5	0					5	125	27,809	5	0	5	134	28,161	5	0	5	136
T4M	25,327	5	0					5	122	27,284	5	0	5	132	27,629	5	0	5	133
TFTM	25,981	5	0					5	126	27,989	5	0	5	135	28,343	5	0	5	137
TSVS	26,164	5	0					1	126	28,185	5	0	1	136	28,542	5	0	1	138
T5S	25,943	4	0					2	125	27,948	5	0	2	135	28,302	5	0	2	137
T5M	25,937	5	0					3	125	27,941	5	0	3	135	28,295	5	0	3	137
TSW	25,704	5	0					4	124	27,691	5	0	4	134	28,041	5	0	4	135
BLC	21,339	4	0					4	103	22,988	4	0	4	111	23,279	4	0	4	112
LCCO	15,240	2	0					4	74	16,418	2	0	4	79	16,626	2	0	4	80
RCCO	15,220	5	0					5	74	16,396	5	0	5	79	16,604	5	0	5	80
90	850	P12	254W					T1S	29,912	4	0	4	118	32,223	4	0	4	127	32,631
				T2S	29,740	5	0	5	117	32,038	5	0	5	126	32,443	5	0	5	128
				T2M	30,277	4	0	4	119	32,616	5	0	5	128	33,029	5	0	5	130
				T3S	29,278	5	0	5	115	31,540	5	0	5	124	31,940	5	0	5	126
				T3M	30,259	5	0	5	119	32,597	5	0	5	128	33,010	5	0	5	130
				T4M	29,688	5	0	5	117	31,982	5	0	5	126	32,387	5	0	5	128
				TFTM	30,455	5	0	5	120	32,808	5	0	5	129	33,224	5	0	5	131
				TSVS	30,669	5	0	1	121	33,039	5	0	1	130	33,457	5	0	1	132
				T5S	30,411	5	0	2	120	32,761	5	0	2	129	33,176	5	0	2	131
				T5M	30,404	5	0	3	120	32,753	5	0	4	129	33,168	5	0	4	131
				TSW	30,131	5	0	4	119	32,459	5	0	4	128	32,870	5	0	4	129
				BLC	25,013	4	0	4	98	26,946	4	0	4	106	27,287	4	0	4	107
				LCCO	17,865	2	0	4	70	19,245	2	0	4	76	19,489	2	0	4	77
				RCCO	17,841	5	0	5	70	19,220	5	0	5	76	19,463	5	0	5	77
				90	1200	P13	344W	T1S	38,768	5	0	5	113	41,764	5	0	5	121	42,292
T2S	38,545	5	0					5	112	41,523	5	0	5	121	42,049	5	0	5	122
T2M	39,241	5	0					5	114	42,273	5	0	5	123	42,808	5	0	5	124
T3S	37,947	5	0					5	110	40,879	5	0	5	119	41,396	5	0	5	120
T3M	39,218	5	0					5	114	42,249	5	0	5	123	42,783	5	0	5	124
T4M	38,478	5	0					5	112	41,451	5	0	5	120	41,976	5	0	5	122
TFTM	39,472	5	0					5	115	42,522	5	0	5	124	43,060	5	0	5	125
TSVS	39,749	5	0					1	116	42,821	5	0	1	124	43,363	5	0	1	126
T5S	39,415	5	0					2	115	42,461	5	0	2	123	42,998	5	0	2	125
T5M	39,405	5	0					4	115	42,450	5	0	4	123	42,988	5	0	4	125
TSW	39,052	5	0					5	114	42,069	5	0	5	122	42,602	5	0	5	124
BLC	32,419	5	0					5	94	34,925	5	0	5	102	35,367	5	0	5	103
LCCO	23,154	3	0					5	67	24,943	3	0	5	73	25,259	3	0	5	73
RCCO	23,124	5	0					5	67	24,910	5	0	5	72	25,226	5	0	5	73
90	1400	P14	405W					T1S	42,867	5	0	5	106	46,180	5	0	5	114	46,764
				T2S	42,621	5	0	5	105	45,914	5	0	5	113	46,495	5	0	5	115
				T2M	43,390	5	0	5	107	46,743	5	0	5	115	47,335	5	0	5	117
				T3S	41,959	5	0	5	104	45,201	5	0	5	112	45,773	5	0	5	113
				T3M	43,365	5	0	5	107	46,716	5	0	5	115	47,307	5	0	5	117
				T4M	42,547	5	0	5	105	45,834	5	0	5	113	46,414	5	0	5	115
				TFTM	43,646	5	0	5	108	47,018	5	0	5	116	47,614	5	0	5	118
				TSVS	43,952	5	0	1	109	47,349	5	0	1	117	47,948	5	0	1	118
				T5S	43,583	5	0	2	108	46,950	5	0	2	116	47,545	5	0	3	117
				T5M	43,572	5	0	4	108	46,939	5	0	4	116	47,533	5	0	4	117
				TSW	43,181	5	0	5	107	46,518	5	0	5	115	47,107	5	0	5	116
				BLC	35,847	5	0	5	89	38,617	5	0	5	95	39,106	5	0	5	97
				LCCO	25,602	3	0	5	63	27,580	3	0	5	68	27,930	3	0	5	69
				RCCO	25,569	5	0	5	63	27,544	5	0	5	68	27,893	5	0	5	69



## Capable Luminaire

This item is an A+ capable luminaire, which has been designed and tested to provide consistent color appearance and system-level interoperability.

- All configurations of this luminaire meet the Acuity Brands' specification for chromatic consistency
- This luminaire is A+ Certified when ordered with DTL® controls marked by a [shaded background](#). DTL DLL equipped luminaires meet the A+ specification for luminaire to photocontrol interoperability<sup>1</sup>
- This luminaire is part of an A+ Certified solution for ROAM® or XPoint™ Wireless control networks, providing out-of-the-box control compatibility with simple commissioning, when ordered with drivers and control options marked by a [shaded background](#)<sup>1</sup>

To learn more about A+, visit [www.acuitybrands.com/aplus](http://www.acuitybrands.com/aplus).

1. See ordering tree for details.
2. A+ Certified Solutions for ROAM require the order of one ROAM node per luminaire.  
Sold Separately: [Link to Roam](#); [Link to DTL DLL](#)

### FEATURES & SPECIFICATIONS

#### INTENDED USE

The sleek design of the D-Series Area Size 2 reflects the embedded high performance LED technology. It is ideal for applications like car dealerships and large parking lots adjacent to malls, transit stations, grocery stores, home centers, and other big-box retailers.

#### CONSTRUCTION

Single-piece die-cast aluminum housing has integral heat sink fins to optimize thermal management through conductive and convective cooling. Modular design allows for ease of maintenance and future light engine upgrades. The LED drivers are mounted in direct contact with the casting to promote low operating temperature and long life. Housing is completely sealed against moisture and environmental contaminants (IP65). Low EPA (1.1 ft<sup>2</sup>) for optimized pole wind loading.

#### FINISH

Exterior parts are protected by a zinc-infused Super Durable TGIC thermoset powder coat finish that provides superior resistance to corrosion and weathering. A tightly controlled multi-stage process ensures a minimum 3 mils thickness for a finish that can withstand extreme climate changes without cracking or peeling. Available in both textured and non-textured finishes.

#### OPTICS

Precision-molded proprietary acrylic lenses are engineered for superior area lighting distribution, uniformity, and pole spacing. Light engines are available in 3000 K, 4000 K, or 5000 K (70 CRI) configurations. The D-Series Size 2 has zero uplight and qualifies as a Nighttime Friendly™ product, meaning it is consistent with the LEED® and Green Globes™ criteria for eliminating wasteful uplight.

#### ELECTRICAL

Light engine configurations consist of high-efficacy LEDs mounted to metal-core circuit boards to maximize heat dissipation and promote long life (up to L85/100,000 hrs at 25°C). Class 1 electronic drivers are designed to have a power factor >90%, THD <20%, and an expected life of 100,000 hours with <1% failure rate. Easily-serviceable 10kV surge protection device meets a minimum Category C Low operation (per ANSI/IEEE C62.41.2).

#### INSTALLATION

Included mounting block and integral arm facilitate quick and easy installation. Stainless steel bolts fasten the mounting block securely to poles and walls, enabling the D-Series Size 2 to withstand up to a 2.0 G vibration load rating per ANSI C136.31. The D-Series Size 2 utilizes the AERIS™ series pole drilling pattern (Template #8). NEMA photocontrol receptacle is available.

#### STANDARD CONTROLS

The DSX2 LED area luminaire has a number of control options. Dusk to dawn controls can be utilized via optional NEMA twist-lock photocell receptacles. Integrated motion sensors with on-board photocells feature field-adjustable programming and are suitable for mounting heights up to 30 feet.

#### nLIGHT AIR CONTROLS

The DSX2 LED area luminaire is also available with nLight® AIR for the ultimate in wireless control. This powerful controls platform provides out-of-the-box basic motion sensing and photocontrol functionality and is suitable for mounting heights up to 40 feet. Once commissioned using a smartphone and the easy-to-use CLAIRITY app, nLight AIR equipped luminaires can be grouped, resulting in motion sensor and photocell group response without the need for additional equipment. Scheduled dimming with motion sensor override can be achieved when used with the nLight Eclipse. Additional information about nLight Air can be found [here](#).

#### LISTINGS

UL Listed for wet locations. Light engines are IP66 rated; luminaire is IP65 rated. Rated for -40°C minimum ambient. U.S. Patent No. D670,857 S. International patent pending.

DesignLights Consortium® (DLC) Premium qualified product and DLC qualified product. Not all versions of this product may be DLC Premium qualified or DLC qualified. Please check the DLC Qualified Products List at [www.designlights.org/QPL](http://www.designlights.org/QPL) to confirm which versions are qualified.

International Dark-Sky Association (IDA) Fixture Seal of Approval (FSA) is available for all products on this page utilizing 3000K color temperature only.

#### WARRANTY

5-year limited warranty. Complete warranty terms located at: [www.acuitybrands.com/support/customer-support/terms-and-conditions](http://www.acuitybrands.com/support/customer-support/terms-and-conditions)

**Note:** Actual performance may differ as a result of end-user environment and application.

All values are design or typical values, measured under laboratory conditions at 25 °C.

Specifications subject to change without notice.



# D-Series Size 2 LED Area Luminaire

d<sup>2</sup>series



## Specifications

<b>EPA:</b>	1.1 ft <sup>2</sup> (0.10 m <sup>2</sup> )
<b>Length:</b>	40" (101.6 cm)
<b>Width:</b>	15" (38.1 cm)
<b>Height 1:</b>	7-1/4" (18.4 cm)
<b>Height 2: (max):</b>	3.5"
<b>Weight:</b>	36lbs

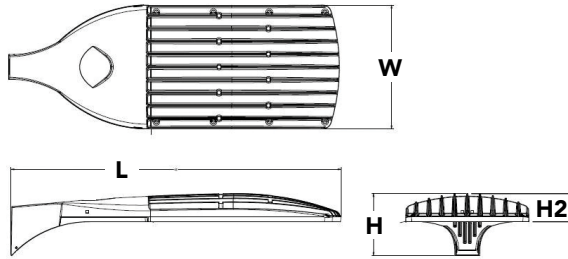

Catalog  
Number

Notes

Type

Hit the Tab key or mouse over the page to see all interactive elements.

## Introduction

The modern styling of the D-Series is striking yet unobtrusive - making a bold, progressive statement even as it blends seamlessly with its environment.

The D-Series distills the benefits of the latest in LED technology into a high performance, high efficacy, long-life luminaire. The outstanding photometric performance results in sites with excellent uniformity, greater pole spacing and lower power density. The Size 2 is ideal for replacing 400-1000W metal halide in area lighting applications with energy savings of up to 80% and expected service life of over 100,000 hours.

A+ Capable options indicated by this color background.

## Ordering Information

**EXAMPLE:** DSX2 LED P7 40K T3M MVOLT SPA NLTAIR2 PIRHN DDBXD

Series	LEDs	Color temperature	Distribution	Voltage	Mounting	
<b>DSX2 LED</b>	<b>Forward optics</b> P1 P5 <b>P2</b> P6 P3 P7 P4 P8 <b>Rotated optics<sup>1</sup></b> P10 P13 P11 P14 P12	30K 3000 K <b>40K</b> <b>4000 K</b> 50K 5000 K	T1S Type I Short (Automotive) T2S Type II Short T2M Type II Medium T3S Type III Short <b>T3M</b> <b>type III Medium</b> T4M Type IV Medium TFTM Forward Throw Medium	T5VS Type V Very Short <sup>2</sup> T5S Type V Short <sup>2</sup> T5M Type V Medium <sup>2</sup> T5W Type V Wide <sup>2</sup> BLC Backlight control <sup>3</sup> LCCO Left corner cutoff <sup>3</sup> RCCO Right corner cutoff <sup>3</sup>	<b>MVOLT<sup>4</sup></b> 120 <sup>5</sup> 208 <sup>5</sup> 240 <sup>5</sup> 277 <sup>5</sup> 347 <sup>5</sup> 480 <sup>5</sup>	<b>Shipped included</b> SPA Square pole mounting RPA Round pole mounting WBA Wall bracket <sup>2</sup> SPUMBA Square pole universal mounting adaptor <sup>6</sup> RPUMBA Round pole universal mounting adaptor <sup>6</sup> <b>Shipped separately</b> KMA8 DDBXD U Mast arm mounting bracket adaptor (specify finish) <sup>7</sup>

Control options	Other options	Finish (required)
<b>Shipped installed</b> NLTAIR2 nLight AIR generation 2 enabled <sup>8</sup> PIRHN Network, Bi-Level motion/ambient sensor <sup>9</sup> PER NEMA twist-lock receptacle only (no controls) <sup>10</sup> PER5 Five-wire receptacle only (no controls) <sup>10,11</sup> PER7 Seven-wire receptacle only (no controls) <sup>10,11</sup> DMG 0-10V dimming extend out back of housing for external control (no controls) <sup>12</sup> DS Dual switching <sup>13,14</sup>	<b>Shipped installed</b> HS House-side shield <sup>16</sup> SF Single fuse (120, 277, 347V) <sup>5</sup> DF Double fuse (208, 240, 480V) <sup>5</sup> L90 Left rotated optics <sup>1</sup> R90 Right rotated optics <sup>1</sup> <b>Shipped separately</b> BS Bird spikes <sup>17</sup> EGS External glare shield	DDBXD Dark bronze DBLXD Black DNAXD Natural aluminum DWHXD White DDBTXD Textured dark bronze DBLBXD Textured black DNATXD Textured natural aluminum DWHGXD Textured white



One Lithonia Way • Conyers, Georgia 30012 • Phone: 1-800-705-SERV (7378) • [www.lithonia.com](http://www.lithonia.com)  
© 2011-2020 Acuity Brands Lighting, Inc. All rights reserved.

DSX2-LED  
Rev. 02/05/20  
Page 1 of 8

## Ordering Information

### Accessories

Ordered and shipped separately.

DLL127F 1.5 JU	Photocell - SSL twist-lock (120-277V) <sup>18</sup>
DLL347F 1.5 CUL JU	Photocell - SSL twist-lock (347V) <sup>18</sup>
DLL480F 1.5 CUL JU	Photocell - SSL twist-lock (480V) <sup>18</sup>
DSHORT SBK U	Shorting cap <sup>18</sup>
DSX2HS 80C U	House-side shield for 80 LED unit <sup>19</sup>
DSX2HS 90C U	House-side shield for 90 LED unit <sup>19</sup>
DSX2HS 100C U	House-side shield for 100 LED unit <sup>19</sup>
PUMBA DDBXD U*	Square and round pole universal mounting bracket (specify finish) <sup>20</sup>
KMA8 DDBXD U	Mast arm mounting bracket adaptor (specify finish) <sup>4</sup>
DSX2EGS (FINISH) U	External glare shield

For more control options, visit [DTL](#) and [ROAM](#) online.

### NOTES

- P10, P11, P12, P13 or P14 and rotated optics (L90, R90) only available together.
- Any Type 5 distribution with photocell, is not available with WBA.
- Not available with HS.
- MVOLT driver operates on any line voltage from 120-277V (50/60 Hz).
- Single fuse (SF) requires 120V, 277V or 347V. Double fuse (DF) requires 208V, 240V or 480V.
- Universal mounting bracket intended for retrofit on existing pre-drilled poles only. 1.5 G vibration load rating per ANCI C136.31.
- Must order fixture with SPA option. Must be ordered as a separate accessory; see Accessories information. For use with 2-3/8" mast arm (not included).
- Must be ordered with PIRHN. Sensor cover only available in dark bronze, black, white or natural aluminum color.
- Must be ordered with NLTAIR2. For more information on nLight Air 2 visit [this link](#).
- Photocell ordered and shipped as a separate line item from Acuity Brands Controls. See accessories. Not available with DS option. Shorting Cap included.
- If ROAM® node required, it must be ordered and shipped as a separate line item from Acuity Brands Controls. Node with integral dimming.
- DMG not available with PIRHN, PER5, PER7, PIR, PIRH, PIR1FC3V or PIRH1FC3V.
- Requires (2) separately switched circuits with isolated neutrals. See Outdoor Control Technical Guide for details.
- Provides 50/50 fixture operation via (2) independent drivers. Not available with PER, PER5, PER7, PIR or PIRH. Not available with P1, P2, P10.
- Reference controls options table on page 4.
- Not available with BLC, LCCO and RCCO distribution. Also available as a separate accessories; see Accessories information.
- Must be ordered with fixture for factory pre-drilling.
- Requires luminaire to be specified with PER, PER5 and PER7 option. Ordered and shipped as a separate line item from Acuity Brands Controls.
- Not available with other dimming controls options.
- For retrofit use only.

## Options

### EGS - External Glare Shield

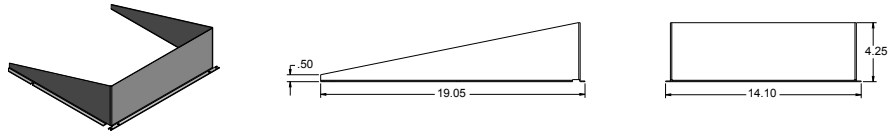

## Drilling

### HANDHOLE ORIENTATION

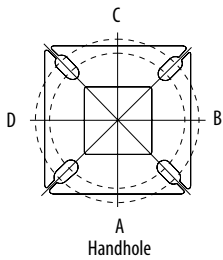

### Tenon Mounting Slipfitter\*\*

Tenon O.D.	Mounting	Single Unit	2 @ 180	2 @ 90	3 @ 120	3 @ 90	4 @ 90
2-3/8"	SPA/RPA	AS3-5 190	AS3-5 280	AS3-5 290	AS3-5 320	AS3-5 390	AS3-5 490
	SPUMBA	AS3-5 190	AS3-5 280	AS4-5 290	AS3-5 320	AS4-5 390	AS4-5 490
	RUPUMBA	AS3-5 190	AS3-5 280		AS3-5 320		
2-7/8"	SPA/RPA	AST25-190	AST25-280	AST25-290	AST25-320	AST25-390	AST25-490
	SPUMBA	AST25-190	AST25-280		AST25-320		
	RUPUMBA	AST25-190	AST25-280		AST25-320		
4"	SPA/RPA	AST35-190	AST35-280	AST35-290	AST35-320	AST35-390	AST35-490
	SPUMBA	AST35-190	AST35-280	AST35-290	AST35-320	AST35-390	AST35-490
	RUPUMBA	AST35-190	AST35-280		AST35-320		

Mounting Option	Drilling Template	Single	2 @ 180	2 @ 90	3 @ 90	3 @ 120	4 @ 90
Head Location		Side B	Side B & D	Side B & C	Side B, C & D	Round Pole Only	Side A, B, C & D
Drill Nomenclature	#8	DM19AS	DM28AS	DM29AS	DM39AS	DM32AS	DM49AS

	Drilling Template	Minimum Acceptable Outside Pole Dimension					
SPA	#8	2-7/8"	2-7/8"	3.5"	3.5"	3"	3.5"
RPA	#8	2-7/8"	2-7/8"	3.5"	3.5"	3"	3.5"
SPUMBA	#5	2-7/8"	3"	4"	4"	3.5"	4"
RPUMBA	#5	2-7/8"	3.5"	5"	5"	3.5"	5"

Template #8

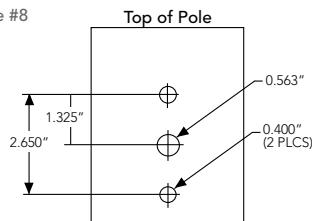

Isofootcandle plots for the DSX2 LED 80C 1000 40K. Distances are in units of mounting height (30').

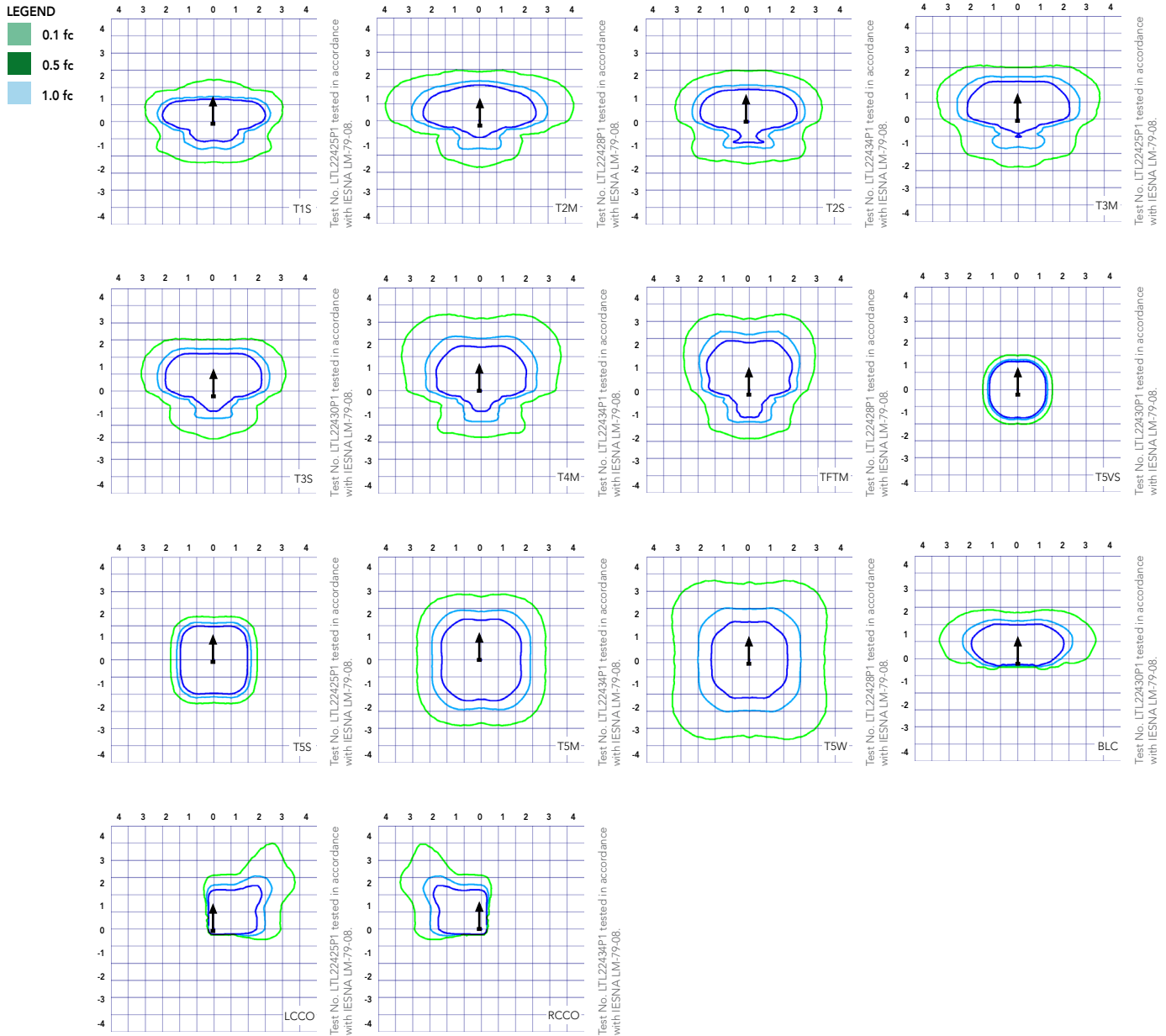

## Performance Data

### Lumen Ambient Temperature (LAT) Multipliers

Use these factors to determine relative lumen output for average ambient temperatures from 0-40°C (32-104°F).

Ambient		Lumen Multiplier
0°C	32°F	1.04
5°C	41°F	1.04
10°C	50°F	1.03
15°C	59°F	1.02
20°C	68°F	1.01
<b>25°C</b>	<b>77°F</b>	<b>1.00</b>
30°C	86°F	0.99
35°C	95°F	0.98
40°C	104°F	0.97

### Projected LED Lumen Maintenance

Data references the extrapolated performance projections for the platforms noted in a **25°C ambient**, based on 10,000 hours of LED testing (tested per IESNA LM-80-08 and projected per IESNA TM-21-11).

To calculate LLF, use the lumen maintenance factor that corresponds to the desired number of operating hours below. For other lumen maintenance values, contact factory.

Operating Hours	0	25000	50000	100000
Lumen Maintenance Factor	1.00	0.96	0.92	0.85

### Electrical Load

	Performance Package	LED Count	Drive Current	Wattage	Current (A)					
					120	208	240	277	347	480
Forward Optics (Non-Rotated)	P1	80	530	140	1.18	0.68	0.59	0.51	0.40	0.32
	P2	80	700	185	1.56	0.90	0.78	0.66	0.52	0.39
	P3	80	850	217	1.82	1.05	0.90	0.80	0.63	0.48
	P4	80	1050	270	2.27	1.31	1.12	0.99	0.79	0.59
	P5	80	1250	321	2.68	1.54	1.34	1.17	0.93	0.68
	P6	100	1050	343	2.89	1.66	1.59	1.37	1.00	0.71
	P7	100	1250	398	3.31	1.91	1.66	1.45	1.16	0.81
	P8	100	1350	431	3.61	2.07	1.81	1.57	1.25	0.91
Rotated Optics (Requires L90 or R90)	P10	90	530	156	1.30	0.76	0.65	0.62	0.45	0.32
	P11	90	700	207	1.75	1.01	0.87	0.74	0.60	0.46
	P12	90	850	254	2.12	1.22	1.06	0.94	0.73	0.55
	P13	90	1200	344	2.88	1.65	1.44	1.25	1.00	0.73
	P14	90	1400	405	3.39	1.95	1.71	1.48	1.18	0.86

Motion Sensor Default Settings						
Option	Dimmed State	High Level (when triggered)	Photocell Operation	Dwell Time	Ramp-up Time	Ramp-down Time
PIR or PIRH	3V (37%) Output	10V (100%) Output	Enabled @ 5FC	5 min	3 sec	5 min
*PIR1FC3V or PIRH1FC3V	3V (37%) Output	10V (100%) Output	Enabled @ 1FC	5 min	3 sec	5 min

\*for use when motion sensor is used as dusk to dawn control.

Controls Options				
Nomenclature	Description	Functionality	Primary control device	Notes
FAO	Field adjustable output device installed inside the luminaire; wired to the driver dimming leads.	Allows the luminaire to be manually dimmed, effectively trimming the light output.	FAO device	Cannot be used with other controls options that need the 0-10V leads
DS	Drivers wired independently for 50/50 luminaire operation	The luminaire is wired to two separate circuits, allowing for 50/50 operation.	Independently wired drivers	Requires two separately switched circuits. Consider nLight AIR as a more cost effective alternative.
PERS or PER7	Twist-lock photocell receptacle	Compatible with standard twist-lock photocells for dusk to dawn operation, or advanced control nodes that provide 0-10V dimming signals.	Twist-lock photocells such as DLL Elite or advanced control nodes such as ROAM.	Pins 4 & 5 to dimming leads on driver, Pins 6 & 7 are capped inside luminaire
PIR or PIRH	Motion sensors with integral photocell. PIR for 8-15' mounting; PIRH for 15-30' mounting	Luminaires dim when no occupancy is detected.	Acuity Controls SBGR	Also available with PIRH1FC3V when the sensor photocell is used for dusk-to-dawn operation.
NLTAIR2 PIRHN	nLight AIR enabled luminaire for motion sensing, photocell and wireless communication.	Motion and ambient light sensing with group response. Scheduled dimming with motion sensor over-ride when wirelessly connected to the nLight Eclipse.	nLight Air rSBGR	nLight AIR sensors can be programmed and commissioned from the ground using the CIAIRity Pro app.

# Performance Data

## Lumen Output

Lumen values are from photometric tests performed in accordance with IESNA LM-79-08. Data is considered to be representative of the configurations shown, within the tolerances allowed by Lighting Facts. Contact factory for performance data on any configurations not shown here.

Forward Optics																			
LED Count	Drive Current	Power Package	System Watts	Dist. Type	30K (3000 K, 70 CRI)					40K (4000 K, 70 CRI)					50K (5000 K, 70 CRI)				
					Lumens	B	U	G	LPW	Lumens	B	U	G	LPW	Lumens	B	U	G	LPW
80	530	P1	140W	T1S	17,575	3	0	3	126	18,933	3	0	3	135	19,173	3	0	3	137
				T2S	17,556	3	0	3	125	18,913	3	0	3	135	19,152	3	0	3	137
				T2M	17,647	3	0	3	126	19,010	3	0	3	136	19,251	3	0	3	138
				T3S	17,090	3	0	3	122	18,411	3	0	3	132	18,644	3	0	3	133
				T3M	17,604	3	0	3	126	18,964	3	0	3	135	19,204	3	0	3	137
				T4M	17,221	3	0	3	123	18,552	3	0	4	133	18,787	3	0	4	134
				TFTM	17,593	3	0	3	126	18,952	3	0	4	135	19,192	3	0	4	137
				TSVS	18,297	4	0	1	131	19,711	4	0	1	141	19,961	4	0	1	143
				T5S	18,312	4	0	2	131	19,727	4	0	2	141	19,977	4	0	2	143
				T5M	18,266	4	0	2	130	19,677	4	0	2	141	19,926	4	0	2	142
				TSW	18,146	5	0	3	130	19,548	5	0	3	140	19,796	5	0	3	141
				BLC	14,424	2	0	2	103	15,539	2	0	3	111	15,736	2	0	3	112
				LCCO	10,733	1	0	3	77	11,562	1	0	3	83	11,709	2	0	3	84
				RCCO	10,733	1	0	3	77	11,562	1	0	3	83	11,709	2	0	3	84
80	700	P2	185W	T1S	22,305	3	0	3	121	24,029	3	0	3	130	24,333	3	0	3	132
				T2S	22,281	3	0	4	120	24,003	3	0	4	130	24,307	3	0	4	131
				T2M	22,396	3	0	3	121	24,127	3	0	3	130	24,432	3	0	3	132
				T3S	21,690	3	0	4	117	23,366	3	0	4	126	23,662	3	0	4	128
				T3M	22,342	3	0	4	121	24,068	3	0	4	130	24,373	3	0	4	132
				T4M	21,857	3	0	4	118	23,545	3	0	4	127	23,844	3	0	4	129
				TFTM	22,328	3	0	4	121	24,054	3	0	4	130	24,358	3	0	4	132
				TSVS	23,222	5	0	1	126	25,016	5	0	1	135	25,333	5	0	1	137
				T5S	23,241	4	0	2	126	25,037	4	0	2	135	25,354	4	0	2	137
				T5M	23,182	5	0	3	125	24,974	5	0	3	135	25,290	5	0	3	137
				TSW	23,030	5	0	4	124	24,810	5	0	4	134	25,124	5	0	4	136
				BLC	18,307	2	0	3	99	19,721	2	0	3	107	19,971	2	0	3	108
				LCCO	13,622	2	0	3	74	14,674	2	0	4	79	14,860	2	0	4	80
				RCCO	13,622	2	0	3	74	14,674	2	0	4	79	14,860	2	0	4	80
80	850	P3	217W	T1S	26,202	3	0	3	121	28,226	3	0	3	130	28,584	3	0	3	132
				T2S	26,174	3	0	4	121	28,196	3	0	4	130	28,553	3	0	4	132
				T2M	26,309	3	0	3	121	28,342	3	0	3	131	28,700	3	0	3	132
				T3S	25,479	3	0	4	117	27,448	3	0	4	126	27,795	3	0	4	128
				T3M	26,245	3	0	4	121	28,273	3	0	4	130	28,631	3	0	4	132
				T4M	25,675	3	0	4	118	27,659	3	0	4	127	28,009	3	0	4	129
				TFTM	26,229	3	0	4	121	28,255	3	0	4	130	28,613	3	0	4	132
				TSVS	27,279	5	0	1	126	29,387	5	0	1	135	29,759	5	0	1	137
				T5S	27,301	4	0	2	126	29,410	5	0	2	136	29,783	5	0	2	137
				T5M	27,232	5	0	3	125	29,336	5	0	3	135	29,707	5	0	3	137
				TSW	27,053	5	0	4	125	29,144	5	0	4	134	29,513	5	0	4	136
				BLC	21,504	2	0	3	99	23,166	2	0	3	107	23,459	2	0	4	108
				LCCO	16,001	2	0	4	74	17,238	2	0	4	79	17,456	2	0	4	80
				RCCO	16,001	2	0	4	74	17,238	2	0	4	79	17,456	2	0	4	80
80	1050	P4	270W	T1S	30,963	4	0	4	115	33,355	4	0	4	124	33,777	4	0	4	125
				T2S	30,930	4	0	4	115	33,320	4	0	4	123	33,742	4	0	4	125
				T2M	31,089	3	0	4	115	33,491	3	0	4	124	33,915	3	0	4	126
				T3S	30,108	4	0	4	112	32,435	4	0	5	120	32,845	4	0	5	122
				T3M	31,014	3	0	4	115	33,410	3	0	4	124	33,833	3	0	4	125
				T4M	30,340	3	0	5	112	32,684	3	0	5	121	33,098	3	0	5	123
				TFTM	30,995	3	0	5	115	33,390	3	0	5	124	33,812	3	0	5	125
				TSVS	32,235	5	0	1	119	34,726	5	0	1	129	35,166	5	0	1	130
				T5S	32,261	5	0	2	119	34,754	5	0	2	129	35,194	5	0	2	130
				T5M	32,180	5	0	4	119	34,667	5	0	4	128	35,105	5	0	4	130
				TSW	31,969	5	0	4	118	34,439	5	0	5	128	34,875	5	0	5	129
				BLC	25,412	2	0	4	94	27,376	2	0	4	101	27,722	2	0	4	103
				LCCO	18,909	2	0	4	70	20,370	2	0	4	75	20,628	2	0	4	76
				RCCO	18,909	2	0	4	70	20,370	2	0	4	75	20,628	2	0	4	76

# Performance Data

## Lumen Output

Lumen values are from photometric tests performed in accordance with IESNA LM-79-08. Data is considered to be representative of the configurations shown, within the tolerances allowed by Lighting Facts. Contact factory for performance data on any configurations not shown here.

Forward Optics																			
LED Count	Drive Current	Power Package	System Watts	Dist. Type	30K (3000 K, 70 CRI)					40K (4000 K, 70 CRI)					50K (5000 K, 70 CRI)				
					Lumens	B	U	G	LPW	Lumens	B	U	G	LPW	Lumens	B	U	G	LPW
80	1250	P5	321W	T1S	35,193	4	0	4	110	37,912	4	0	4	118	38,392	4	0	4	120
				T2S	35,155	4	0	5	110	37,872	4	0	5	118	38,351	4	0	5	119
				T2M	35,336	4	0	4	110	38,067	4	0	4	119	38,549	4	0	4	120
				T3S	34,222	4	0	5	107	36,866	4	0	5	115	37,333	4	0	5	116
				T3M	35,251	3	0	4	110	37,974	3	0	5	118	38,455	4	0	5	120
				T4M	34,485	3	0	5	107	37,149	4	0	5	116	37,620	4	0	5	117
				TFTM	35,229	3	0	5	110	37,951	3	0	5	118	38,431	3	0	5	120
				TSVS	36,639	5	0	1	114	39,470	5	0	1	123	39,970	5	0	1	125
				T5S	36,669	5	0	2	114	39,502	5	0	2	123	40,002	5	0	2	125
				T5M	36,576	5	0	4	114	39,403	5	0	4	123	39,901	5	0	4	124
				TSW	36,336	5	0	5	113	39,144	5	0	5	122	39,640	5	0	5	123
				BLC	28,884	3	0	4	90	31,115	3	0	4	97	31,509	3	0	4	98
				LCCO	21,492	2	0	4	67	23,153	2	0	5	72	23,446	3	0	5	73
				RCCO	21,492	2	0	4	67	23,153	2	0	5	72	23,446	3	0	5	73
100	1050	P6	343W	T1S	37,824	4	0	4	110	40,747	4	0	4	119	41,263	4	0	4	120
				T2S	37,784	4	0	5	110	40,704	4	0	5	119	41,219	4	0	5	120
				T2M	37,979	4	0	4	111	40,913	4	0	4	119	41,431	4	0	4	121
				T3S	36,780	4	0	5	107	39,623	4	0	5	116	40,124	4	0	5	117
				T3M	37,886	3	0	5	110	40,814	4	0	5	119	41,331	4	0	5	120
				T4M	37,063	4	0	5	108	39,927	4	0	5	116	40,433	4	0	5	118
				TFTM	37,863	3	0	5	110	40,789	4	0	5	119	41,305	4	0	5	120
				TSVS	39,379	5	0	1	115	42,422	5	0	1	124	42,959	5	0	1	125
				T5S	39,411	5	0	2	115	42,456	5	0	2	124	42,993	5	0	2	125
				T5M	39,311	5	0	4	115	42,349	5	0	4	123	42,885	5	0	4	125
				TSW	39,053	5	0	5	114	42,071	5	0	5	123	42,604	5	0	5	124
				BLC	31,043	3	0	4	91	33,442	3	0	4	97	33,865	3	0	4	99
				LCCO	23,099	2	0	5	67	24,884	3	0	5	73	25,199	3	0	5	73
				RCCO	23,099	2	0	5	67	24,884	3	0	5	73	25,199	3	0	5	73
100	1250	P7	398W	T1S	42,599	4	0	4	107	45,890	4	0	4	115	46,471	4	0	4	117
				T2S	42,553	4	0	5	107	45,842	4	0	5	115	46,422	4	0	5	117
				T2M	42,773	4	0	4	107	46,078	4	0	4	116	46,661	4	0	5	117
				T3S	41,423	4	0	5	104	44,624	4	0	5	112	45,189	4	0	5	114
				T3M	42,669	4	0	5	107	45,966	4	0	5	115	46,548	4	0	5	117
				T4M	41,742	4	0	5	105	44,967	4	0	5	113	45,537	4	0	5	114
				TFTM	42,643	4	0	5	107	45,938	4	0	5	115	46,519	4	0	5	117
				TSVS	44,350	5	0	1	111	47,777	5	0	1	120	48,381	5	0	1	122
				T5S	44,385	5	0	2	112	47,815	5	0	3	120	48,420	5	0	3	122
				T5M	44,273	5	0	4	111	47,695	5	0	4	120	48,298	5	0	4	121
				TSW	43,983	5	0	5	111	47,382	5	0	5	119	47,982	5	0	5	121
				BLC	34,962	3	0	4	88	37,664	3	0	5	95	38,140	3	0	5	96
				LCCO	26,015	3	0	5	65	28,025	3	0	5	70	28,380	3	0	5	71
				RCCO	26,015	3	0	5	65	28,025	3	0	5	70	28,380	3	0	5	71
100	1350	P8	448W	T1S	45,610	4	0	4	106	49,135	4	0	4	114	49,757	4	0	4	115
				T2S	45,562	4	0	5	106	49,083	4	0	5	114	49,704	4	0	5	115
				T2M	45,797	4	0	4	106	49,336	4	0	5	114	49,960	4	0	5	116
				T3S	44,352	4	0	5	103	47,779	4	0	5	111	48,384	4	0	5	112
				T3M	45,686	4	0	5	106	49,216	4	0	5	114	49,839	4	0	5	116
				T4M	44,693	4	0	5	104	48,147	4	0	5	112	48,756	4	0	5	113
				TFTM	45,657	4	0	5	106	49,186	4	0	5	114	49,808	4	0	5	116
				TSVS	47,485	5	0	1	110	51,155	5	0	1	119	51,802	5	0	1	120
				T5S	47,524	5	0	3	110	51,196	5	0	3	119	51,844	5	0	3	120
				T5M	47,404	5	0	4	110	51,067	5	0	5	118	51,713	5	0	5	120
				TSW	47,093	5	0	5	109	50,732	5	0	5	118	51,374	5	0	5	119
				BLC	37,434	3	0	5	87	40,326	3	0	5	94	40,837	3	0	5	95
				LCCO	27,854	3	0	5	65	30,006	3	0	5	70	30,386	3	0	5	71
				RCCO	27,854	3	0	5	65	30,006	3	0	5	70	30,386	3	0	5	71



# Performance Data

## Lumen Output

Lumen values are from photometric tests performed in accordance with IESNA LM-79-08. Data is considered to be representative of the configurations shown, within the tolerances allowed by Lighting Facts. Contact factory for performance data on any configurations not shown here.

Rotated Optics																			
LED Count	Drive Current	Power Package	System Watts	Dist. Type	30K (3000 K, 70 CRI)					40K (4000 K, 70 CRI)					50K (5000 K, 70 CRI)				
					Lumens	B	U	G	LPW	Lumens	B	U	G	LPW	Lumens	B	U	G	LPW
90	530	P10	156W	T1S	20,145	4	0	4	129	21,702	4	0	4	139	21,977	4	0	4	141
				T2S	20,029	4	0	4	128	21,577	4	0	4	138	21,850	4	0	4	140
				T2M	20,391	4	0	4	131	21,967	4	0	4	141	22,245	4	0	4	143
				T3S	19,719	4	0	4	126	21,242	4	0	4	136	21,511	4	0	4	138
				T3M	20,379	4	0	4	131	21,954	4	0	4	141	22,232	4	0	4	143
				T4M	19,995	4	0	4	128	21,540	4	0	4	138	21,812	5	0	5	140
				TFTM	20,511	4	0	4	131	22,096	5	0	5	142	22,376	5	0	5	143
				TSVS	20,655	4	0	1	132	22,251	4	0	1	143	22,533	4	0	1	144
				T5S	20,482	4	0	2	131	22,064	4	0	2	141	22,343	4	0	2	143
				T5M	20,477	5	0	3	131	22,059	5	0	3	141	22,338	5	0	3	143
				TSW	20,293	5	0	3	130	21,861	5	0	3	140	22,138	5	0	4	142
				BLC	16,846	4	0	4	108	18,148	4	0	4	116	18,378	4	0	4	118
				LCCO	12,032	2	0	3	77	12,961	2	0	3	83	13,125	2	0	3	84
				RCCO	12,016	4	0	4	77	12,944	4	0	4	83	13,108	4	0	4	84
				90	700	P11	207W	T1S	25,518	4	0	4	123	27,490	4	0	4	133	27,837
T2S	25,371	5	0					5	123	27,331	5	0	5	132	27,677	5	0	5	134
T2M	25,829	4	0					4	125	27,825	4	0	4	134	28,177	4	0	4	136
T3S	24,977	5	0					5	121	26,907	5	0	5	130	27,248	5	0	5	132
T3M	25,814	5	0					5	125	27,809	5	0	5	134	28,161	5	0	5	136
T4M	25,327	5	0					5	122	27,284	5	0	5	132	27,629	5	0	5	133
TFTM	25,981	5	0					5	126	27,989	5	0	5	135	28,343	5	0	5	137
TSVS	26,164	5	0					1	126	28,185	5	0	1	136	28,542	5	0	1	138
T5S	25,943	4	0					2	125	27,948	5	0	2	135	28,302	5	0	2	137
T5M	25,937	5	0					3	125	27,941	5	0	3	135	28,295	5	0	3	137
TSW	25,704	5	0					4	124	27,691	5	0	4	134	28,041	5	0	4	135
BLC	21,339	4	0					4	103	22,988	4	0	4	111	23,279	4	0	4	112
LCCO	15,240	2	0					4	74	16,418	2	0	4	79	16,626	2	0	4	80
RCCO	15,220	5	0					5	74	16,396	5	0	5	79	16,604	5	0	5	80
90	850	P12	254W					T1S	29,912	4	0	4	118	32,223	4	0	4	127	32,631
				T2S	29,740	5	0	5	117	32,038	5	0	5	126	32,443	5	0	5	128
				T2M	30,277	4	0	4	119	32,616	5	0	5	128	33,029	5	0	5	130
				T3S	29,278	5	0	5	115	31,540	5	0	5	124	31,940	5	0	5	126
				T3M	30,259	5	0	5	119	32,597	5	0	5	128	33,010	5	0	5	130
				T4M	29,688	5	0	5	117	31,982	5	0	5	126	32,387	5	0	5	128
				TFTM	30,455	5	0	5	120	32,808	5	0	5	129	33,224	5	0	5	131
				TSVS	30,669	5	0	1	121	33,039	5	0	1	130	33,457	5	0	1	132
				T5S	30,411	5	0	2	120	32,761	5	0	2	129	33,176	5	0	2	131
				T5M	30,404	5	0	3	120	32,753	5	0	4	129	33,168	5	0	4	131
				TSW	30,131	5	0	4	119	32,459	5	0	4	128	32,870	5	0	4	129
				BLC	25,013	4	0	4	98	26,946	4	0	4	106	27,287	4	0	4	107
				LCCO	17,865	2	0	4	70	19,245	2	0	4	76	19,489	2	0	4	77
				RCCO	17,841	5	0	5	70	19,220	5	0	5	76	19,463	5	0	5	77
				90	1200	P13	344W	T1S	38,768	5	0	5	113	41,764	5	0	5	121	42,292
T2S	38,545	5	0					5	112	41,523	5	0	5	121	42,049	5	0	5	122
T2M	39,241	5	0					5	114	42,273	5	0	5	123	42,808	5	0	5	124
T3S	37,947	5	0					5	110	40,879	5	0	5	119	41,396	5	0	5	120
T3M	39,218	5	0					5	114	42,249	5	0	5	123	42,783	5	0	5	124
T4M	38,478	5	0					5	112	41,451	5	0	5	120	41,976	5	0	5	122
TFTM	39,472	5	0					5	115	42,522	5	0	5	124	43,060	5	0	5	125
TSVS	39,749	5	0					1	116	42,821	5	0	1	124	43,363	5	0	1	126
T5S	39,415	5	0					2	115	42,461	5	0	2	123	42,998	5	0	2	125
T5M	39,405	5	0					4	115	42,450	5	0	4	123	42,988	5	0	4	125
TSW	39,052	5	0					5	114	42,069	5	0	5	122	42,602	5	0	5	124
BLC	32,419	5	0					5	94	34,925	5	0	5	102	35,367	5	0	5	103
LCCO	23,154	3	0					5	67	24,943	3	0	5	73	25,259	3	0	5	73
RCCO	23,124	5	0					5	67	24,910	5	0	5	72	25,226	5	0	5	73
90	1400	P14	405W					T1S	42,867	5	0	5	106	46,180	5	0	5	114	46,764
				T2S	42,621	5	0	5	105	45,914	5	0	5	113	46,495	5	0	5	115
				T2M	43,390	5	0	5	107	46,743	5	0	5	115	47,335	5	0	5	117
				T3S	41,959	5	0	5	104	45,201	5	0	5	112	45,773	5	0	5	113
				T3M	43,365	5	0	5	107	46,716	5	0	5	115	47,307	5	0	5	117
				T4M	42,547	5	0	5	105	45,834	5	0	5	113	46,414	5	0	5	115
				TFTM	43,646	5	0	5	108	47,018	5	0	5	116	47,614	5	0	5	118
				TSVS	43,952	5	0	1	109	47,349	5	0	1	117	47,948	5	0	1	118
				T5S	43,583	5	0	2	108	46,950	5	0	2	116	47,545	5	0	3	117
				T5M	43,572	5	0	4	108	46,939	5	0	4	116	47,533	5	0	4	117
				TSW	43,181	5	0	5	107	46,518	5	0	5	115	47,107	5	0	5	116
				BLC	35,847	5	0	5	89	38,617	5	0	5	95	39,106	5	0	5	97
				LCCO	25,602	3	0	5	63	27,580	3	0	5	68	27,930	3	0	5	69
				RCCO	25,569	5	0	5	63	27,544	5	0	5	68	27,893	5	0	5	69

## Capable Luminaire

This item is an A+ capable luminaire, which has been designed and tested to provide consistent color appearance and system-level interoperability.

- All configurations of this luminaire meet the Acuity Brands' specification for chromatic consistency
- This luminaire is A+ Certified when ordered with DTL® controls marked by a [shaded background](#). DTL DLL equipped luminaires meet the A+ specification for luminaire to photocontrol interoperability<sup>1</sup>
- This luminaire is part of an A+ Certified solution for ROAM® or XPoint™ Wireless control networks, providing out-of-the-box control compatibility with simple commissioning, when ordered with drivers and control options marked by a [shaded background](#)<sup>1</sup>

To learn more about A+, visit [www.acuitybrands.com/aplus](http://www.acuitybrands.com/aplus).

1. See ordering tree for details.
2. A+ Certified Solutions for ROAM require the order of one ROAM node per luminaire.  
Sold Separately: [Link to Roam](#); [Link to DTL DLL](#)

### FEATURES & SPECIFICATIONS

#### INTENDED USE

The sleek design of the D-Series Area Size 2 reflects the embedded high performance LED technology. It is ideal for applications like car dealerships and large parking lots adjacent to malls, transit stations, grocery stores, home centers, and other big-box retailers.

#### CONSTRUCTION

Single-piece die-cast aluminum housing has integral heat sink fins to optimize thermal management through conductive and convective cooling. Modular design allows for ease of maintenance and future light engine upgrades. The LED drivers are mounted in direct contact with the casting to promote low operating temperature and long life. Housing is completely sealed against moisture and environmental contaminants (IP65). Low EPA (1.1 ft<sup>2</sup>) for optimized pole wind loading.

#### FINISH

Exterior parts are protected by a zinc-infused Super Durable TGIC thermoset powder coat finish that provides superior resistance to corrosion and weathering. A tightly controlled multi-stage process ensures a minimum 3 mils thickness for a finish that can withstand extreme climate changes without cracking or peeling. Available in both textured and non-textured finishes.

#### OPTICS

Precision-molded proprietary acrylic lenses are engineered for superior area lighting distribution, uniformity, and pole spacing. Light engines are available in 3000 K, 4000 K, or 5000 K (70 CRI) configurations. The D-Series Size 2 has zero uplight and qualifies as a Nighttime Friendly™ product, meaning it is consistent with the LEED® and Green Globes™ criteria for eliminating wasteful uplight.

#### ELECTRICAL

Light engine configurations consist of high-efficacy LEDs mounted to metal-core circuit boards to maximize heat dissipation and promote long life (up to L85/100,000 hrs at 25°C). Class 1 electronic drivers are designed to have a power factor >90%, THD <20%, and an expected life of 100,000 hours with <1% failure rate. Easily-serviceable 10kV surge protection device meets a minimum Category C Low operation (per ANSI/IEEE C62.41.2).

#### INSTALLATION

Included mounting block and integral arm facilitate quick and easy installation. Stainless steel bolts fasten the mounting block securely to poles and walls, enabling the D-Series Size 2 to withstand up to a 2.0 G vibration load rating per ANSI C136.31. The D-Series Size 2 utilizes the AERIS™ series pole drilling pattern (Template #8). NEMA photocontrol receptacle is available.

#### STANDARD CONTROLS

The DSX2 LED area luminaire has a number of control options. Dusk to dawn controls can be utilized via optional NEMA twist-lock photocell receptacles. Integrated motion sensors with on-board photocells feature field-adjustable programming and are suitable for mounting heights up to 30 feet.

#### nLIGHT AIR CONTROLS

The DSX2 LED area luminaire is also available with nLight® AIR for the ultimate in wireless control. This powerful controls platform provides out-of-the-box basic motion sensing and photocontrol functionality and is suitable for mounting heights up to 40 feet. Once commissioned using a smartphone and the easy-to-use CLAIRITY app, nLight AIR equipped luminaires can be grouped, resulting in motion sensor and photocell group response without the need for additional equipment. Scheduled dimming with motion sensor override can be achieved when used with the nLight Eclipse. Additional information about nLight Air can be found [here](#).

#### LISTINGS

UL Listed for wet locations. Light engines are IP66 rated; luminaire is IP65 rated. Rated for -40°C minimum ambient. U.S. Patent No. D670,857 S. International patent pending.

DesignLights Consortium® (DLC) Premium qualified product and DLC qualified product. Not all versions of this product may be DLC Premium qualified or DLC qualified. Please check the DLC Qualified Products List at [www.designlights.org/QPL](http://www.designlights.org/QPL) to confirm which versions are qualified.

International Dark-Sky Association (IDA) Fixture Seal of Approval (FSA) is available for all products on this page utilizing 3000K color temperature only.

#### WARRANTY

5-year limited warranty. Complete warranty terms located at: [www.acuitybrands.com/support/customer-support/terms-and-conditions](http://www.acuitybrands.com/support/customer-support/terms-and-conditions)

**Note:** Actual performance may differ as a result of end-user environment and application.

All values are design or typical values, measured under laboratory conditions at 25 °C.  
Specifications subject to change without notice.

# D-Series Size 2 LED Wall Luminaire



d<sup>series</sup>

## Specifications Luminaire

**Width:** 18-1/2" (47.0 cm) **Weight:** 21 lbs (9.5 kg)  
**Depth:** 10" (25.4 cm)  
**Height:** 7-5/8" (19.4 cm)

## Back Box (BBW)

**Width:** 5-1/2" (14.0 cm) **BBW Weight:** 1 lbs (0.5 kg)  
**Depth:** 1-1/2" (3.8 cm)  
**Height:** 4" (10.2 cm)

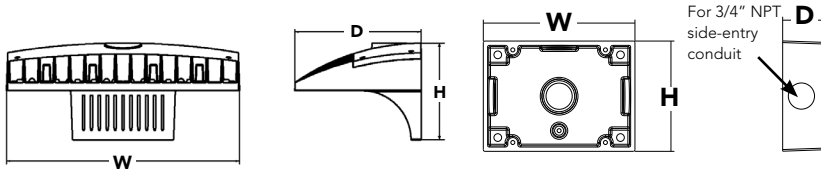

Catalog Number
Notes
Type

Hit the Tab key or mouse over the page to see all interactive elements.

## A+ Capable Luminaire

This item is an A+ capable luminaire, which has been designed and tested to provide consistent color appearance and system-level interoperability.

- All configurations of this luminaire meet the Acuity Brands' specification for chromatic consistency
- This luminaire is A+ Certified when ordered with DTL® controls marked by a shaded background. DTL DLL equipped luminaires meet the A+ specification for luminaire to photocontrol interoperability<sup>1</sup>
- This luminaire is part of an A+ Certified solution for ROAM® or XPoint™ Wireless control networks, providing out-of-the-box control compatibility with simple commissioning, when ordered with drivers and control options marked by a shaded background<sup>1</sup>

To learn more about A+, visit [www.acuitybrands.com/aplus](http://www.acuitybrands.com/aplus).

- See ordering tree for details.
- A+ Certified Solutions for ROAM require the order of one ROAM node per luminaire. Sold Separately: [Link to Roam](#); [Link to DTL DLL](#)

A+ Capable options indicated by this color background.

## Ordering Information

EXAMPLE: DSXW2 LED 30C 700 40K T3M MVOLT DDBTXD

Series	LEDs	Drive Current	Color temperature	Distribution	Voltage	Mounting	Control Options
<b>DSXW2 LED</b>							
<b>DSXW2 LED</b>	20C 20 LEDs (two engines) <b>30C</b> 30 LEDs (three engines)	350 350 mA 530 530 mA <b>700 700 mA</b> 1000 1000 mA <sup>1</sup> (1 A)	30K 3000 K 40K 4000 K 50K 5000 K AMBPC Amber phosphor converted <sup>2</sup>	T2S Type II Short T2M Type II Medium T3S Type III Short T3M Type III Medium T4M Type IV Medium <b>TFTM Forward Throw Medium</b>	MVOLT <sup>3</sup> 120 <sup>4</sup> 208 <sup>4</sup> 240 <sup>4</sup> 277 <sup>4</sup> 347 <sup>4,5</sup> 480 <sup>4,5</sup>	<b>Shipped included</b> (blank) Surface mounting bracket  <b>Shipped separately<sup>6</sup></b> BBW Surface-mounted back box (for conduit entry)	<b>Shipped installed</b> PE Photoelectric cell, button type <sup>7</sup> PER NEMA twist-lock receptacle only (control ordered separately) <sup>8</sup> PER5 Five-wire receptacle only (control ordered separately) <sup>8,9</sup> PER7 Seven-wire receptacle only (control ordered separately) <sup>8,9</sup> DMG 0-10v dimming wires pulled outside fixture (for use with an external control, ordered separately) PIR 180° motion/ambient light sensor, <15' mtg ht <sup>10,11</sup> PIRH 180° motion/ambient light sensor, 15-30' mtg ht <sup>10,11</sup> PIR1FC3V Motion/ambient sensor, 8-15' mounting height, ambient sensor enabled at 1fc <sup>11,12</sup> PIRH1FC3V Motion/ambient sensor, 15-30' mounting height, ambient sensor enabled at 1fc <sup>11,12</sup>

Other Options	Finish (required)
<b>Shipped installed</b>	
SF Single fuse (120, 277, 347V) <sup>3</sup>	DDBXD Dark bronze
DF Double fuse (208, 240, 480V) <sup>3</sup>	DBLXD Black
HS House-side shield <sup>4</sup>	DNAXD Natural aluminum
SPD Separate surge protection <sup>13</sup>	DWHXD White
<b>Shipped separately<sup>13</sup></b>	
BSW Bird-deterrent spikes	DSSXD Sandstone
VG Vandal guard	DDBTXD Textured dark bronze
	DBLBXD Textured black
	DNATXD Textured natural aluminum
	DWHGXD Textured white
	DSSTXD Textured sandstone



## Ordering Information

### Accessories

Ordered and shipped separately.

DLL127F 1.5 JU	Photozell - SSL twist-lock (120-277V) <sup>14</sup>
DLL347F 1.5 CULJU	Photozell - SSL twist-lock (347V) <sup>14</sup>
DLL480F 1.5 CULJU	Photozell - SSL twist-lock (480V) <sup>14</sup>
DSHORT SBK U	Shorting cap (Included when ordering PER, PER5 or PER7) <sup>14</sup>
DSXWHS U	House-side shield (one per light engine)
DSXWBSW U	Bird-deterrent spikes
DSXW2VG U	Vandal guard accessory
DSXW2BBW	Back box accessory
DBBXDU U	(specify finish)

For more control options, visit [DTL](#) and [ROAM](#) online.

### NOTES

- 1000mA is not available with AMBPC.
- AMBPC is not available with 1000mA.
- MVOLT driver operates on any line voltage from 120-277V (50/60 Hz).
- Single fuse (SF) requires 120, 277 or 347 voltage option. Double fuse (DF) requires 208, 240 or 480 voltage option.
- Available with 30 LED/700mA options only (DSXW2 LED 30C 700). DMG option not available.
- Also available as a separate accessory; see Accessories information.
- Photocontrol (PE) requires 120, 208, 240, 277 or 347 voltage option. Not available with motion/ambient light sensors (PIR or PIRH).
- Photozell ordered and shipped as a separate line item from Acuity Brands Controls. See accessories. Shorting Cap included.
- If ROAM® node required, it must be ordered and shipped as a separate line item from Acuity Brands Controls. Shorting Cap included.
- Reference Motion Sensor table on page 3.
- Reference PER Table on page 3 for functionality.
- PIR and PIR1FC3V specify the [SensorSwitch SBGR-10-ODP](#) control; PIRH and PIRH1FC3V specify the [SensorSwitch SBGR-6-ODP](#) control; see [Motion Sensor Guide](#) for details. Dimming driver standard. Not available with PER5 or PER7. Separate on/off required.
- See the electrical section on page 2 for more details.
- Requires luminaire to be specified with PER option. Ordered and shipped as a separate line item. See PER Table.

## Performance Data

### Lumen Output

Lumen values are from photometric tests performed in accordance with IESNA LM-79-08. Data is considered to be representative of the configurations shown, within the tolerances allowed by Lighting Facts. Contact factory for performance data on any configurations not shown here.

LEDs	Drive Current (mA)	System Watts	Dist. Type	30K					40K					50K				
				Lumens	B	U	G	LPW	Lumens	B	U	G	LPW	Lumens	B	U	G	LPW
20C (20 LEDs)	350 mA	25W	T2S	2,783	1	0	1	111	2,989	1	0	1	120	3,008	1	0	1	120
			T2M	2,709	1	0	1	108	2,908	1	0	1	116	2,926	1	0	1	117
			T3S	2,748	1	0	1	110	2,951	1	0	1	118	2,969	1	0	1	119
			T3M	2,793	1	0	1	112	2,999	1	0	1	120	3,018	1	0	1	121
			T4M	2,756	1	0	1	110	2,959	1	0	1	118	2,977	1	0	1	119
			TFTM	2,753	1	0	1	110	2,956	1	0	1	118	2,975	1	0	1	119
	530 mA	36W	T2S	4,030	1	0	1	112	4,327	1	0	1	120	4,354	1	0	1	121
			T2M	3,920	1	0	1	109	4,210	1	0	1	117	4,236	1	0	1	118
			T3S	3,978	1	0	1	111	4,272	1	0	1	119	4,299	1	0	1	119
			T3M	4,044	1	0	2	112	4,343	1	0	2	121	4,370	1	0	2	121
			T4M	3,990	1	0	1	111	4,284	1	0	1	119	4,310	1	0	1	120
			TFTM	3,987	1	0	1	111	4,281	1	0	1	119	4,308	1	0	1	120
	700 mA	47W	T2S	5,130	1	0	1	109	5,509	1	0	1	117	5,544	1	0	1	118
			T2M	4,991	1	0	2	106	5,360	1	0	2	114	5,393	1	0	2	115
			T3S	5,066	1	0	1	108	5,440	1	0	1	116	5,474	1	0	1	116
			T3M	5,148	1	0	2	110	5,529	1	0	2	118	5,563	1	0	2	118
			T4M	5,080	1	0	2	108	5,455	1	0	2	116	5,488	1	0	2	117
			TFTM	5,075	1	0	2	108	5,450	1	0	2	116	5,484	1	0	2	117
	1000 mA	73W	T2S	7,147	2	0	2	98	7,675	2	0	2	105	7,723	1	0	1	104
			T2M	6,954	2	0	2	95	7,467	2	0	2	102	7,514	2	0	2	103
			T3S	7,057	1	0	2	97	7,579	1	0	2	104	7,627	1	0	2	104
			T3M	7,172	2	0	3	98	7,702	2	0	3	106	7,751	2	0	3	106
			T4M	7,076	1	0	2	97	7,599	1	0	2	104	7,646	1	0	2	105
			TFTM	7,071	1	0	2	97	7,594	1	0	2	104	7,641	1	0	2	105
30C (30 LEDs)	350 mA	36W	T2S	4,160	1	0	1	116	4,467	1	0	1	124	4,494	1	0	1	125
			T2M	4,048	1	0	1	112	4,346	1	0	2	121	4,373	1	0	2	121
			T3S	4,108	1	0	1	114	4,411	1	0	1	123	4,438	1	0	1	123
			T3M	4,174	1	0	2	116	4,483	1	0	2	125	4,510	1	0	2	125
			T4M	4,119	1	0	1	114	4,423	1	0	2	123	4,450	1	0	2	124
			TFTM	4,115	1	0	1	114	4,419	1	0	1	123	4,446	1	0	1	124
	530 mA	54W	T2S	6,001	1	0	1	111	6,444	1	0	1	119	6,484	1	0	1	120
			T2M	5,838	1	0	2	108	6,270	2	0	2	116	6,308	2	0	2	117
			T3S	5,926	1	0	2	110	6,364	1	0	2	118	6,403	1	0	2	119
			T3M	6,023	1	0	2	112	6,467	1	0	2	120	6,507	1	0	2	121
			T4M	5,942	1	0	2	110	6,380	1	0	2	118	6,420	1	0	2	119
			TFTM	5,937	1	0	2	110	6,376	1	0	2	118	6,415	1	0	2	119
	700 mA	71W	T2S	7,403	2	0	2	104	8,170	2	0	2	115	8,221	2	0	2	116
			T2M	7,609	2	0	2	107	7,949	2	0	2	112	7,998	2	0	2	113
			T3S	7,513	1	0	2	106	8,068	1	0	2	114	8,118	1	0	2	114
			T3M	7,635	2	0	3	108	8,199	2	0	3	115	8,250	2	0	3	116
			T4M	7,534	1	0	2	106	8,089	1	0	2	114	8,140	1	0	2	115
			TFTM	7,527	1	0	2	106	8,082	2	0	2	114	8,134	2	0	2	115
	1000 mA	109W	T2S	10,468	2	0	2	96	11,241	2	0	2	103	11,311	2	0	2	104
			T2M	10,184	2	0	3	93	10,936	2	0	3	100	11,005	2	0	3	101
			T3S	10,335	2	0	2	95	11,099	2	0	2	102	11,169	2	0	2	102
			T3M	10,505	2	0	3	96	11,280	2	0	3	103	11,351	2	0	3	104
			T4M	10,365	2	0	2	95	11,129	2	0	2	102	11,198	2	0	2	103
			TFTM	10,356	2	0	2	95	11,121	2	0	3	102	11,190	2	0	3	103

#### Note:

Available with phosphor-converted amber LED's (nomenclature AMBPC). These LED's produce light with 97+% >530 nm. Output can be calculated by applying a 0.7 factor to 4000 K lumen values and photometric files.



## Performance Data

### Lumen Ambient Temperature (LAT) Multipliers

Use these factors to determine relative lumen output for average ambient temperatures from 0-40°C (32-104°F).

Ambient		Lumen Multiplier
0°C	32°F	1.02
10°C	50°F	1.01
20°C	68°F	1.00
<b>25°C</b>	<b>77°F</b>	<b>1.00</b>
30°C	86°F	1.00
40°C	104°F	0.98

### Electrical Load

LEDs	Drive Current (mA)	System Watts	Current (A)					
			120V	208V	240V	277V	347V	480V
20C	350	25 W	0.23	0.13	0.12	0.10	-	-
	530	36 W	0.33	0.19	0.17	0.14	-	-
	700	47 W	0.44	0.25	0.22	0.19	-	-
	1000	74 W	0.68	0.39	0.34	0.29	-	-
30C	350	36 W	0.33	0.19	0.17	0.14	-	-
	530	54 W	0.50	0.29	0.25	0.22	-	-
	700	71 W	0.66	0.38	0.33	0.28	0.23	0.16
	1000	109 W	1.01	0.58	0.50	0.44	-	-

### Projected LED Lumen Maintenance

Data references the extrapolated performance projections for the **DSXW2 LED 30C 1000** platform in a **25°C ambient**, based on 10,000 hours of LED testing (tested per IESNA LM-80-08 and projected per IESNA TM-21-11).

To calculate LLF, use the lumen maintenance factor that corresponds to the desired number of operating hours below. For other lumen maintenance values, contact factory.

Operating Hours	0	25,000	50,000	100,000
Lumen Maintenance Factor	1.0	0.95	0.92	0.87

### Motion Sensor Default Settings

Option	Dimmed State	High Level (when triggered)	Photocell Operation	Dwell Time	Ramp-up Time	Ramp-down Time
*PIR or PIRH	3V (37%) Output	10V (100%) Output	Enabled @ 5FC	5 min	3 sec	5 min
PIR1FC3V or PIRH1FC3V	3V (37%) Output	10V (100%) Output	Enabled @ 1FC	5 min	3 sec	5 min

\*for use with Inline Dusk to Dawn or timer

### PER Table

Control	PER (3 wire)	PER5 (5 wire)		PER7 (7 wire)		
			Wire 4/Wire5		Wire 4/Wire5	Wire 6/Wire7
Photocontrol Only (On/Off)	✓	⚠	Wired to dimming leads on driver	⚠	Wired to dimming leads on driver	Wires Capped inside fixture
ROAM	⊘	✓	Wired to dimming leads on driver	⚠	Wired to dimming leads on driver	Wires Capped inside fixture
ROAM with Motion	⊘	⚠	Wired to dimming leads on driver	⚠	Wired to dimming leads on driver	Wires Capped inside fixture
Futureproof*	⊘	⚠	Wired to dimming leads on driver	✓	Wired to dimming leads on driver	Wires Capped inside fixture
Futureproof* with Motion	⊘	⚠	Wired to dimming leads on driver	✓	Wired to dimming leads on driver	Wires Capped inside fixture

- ✓ Recommended
- ⊘ Will not work
- ⚠ Alternate

\*Futureproof means: Ability to change controls in the future.

Isofootcandle plots for the DSXW2 LED 30C 1000 40K. Distances are in units of mounting height (25').

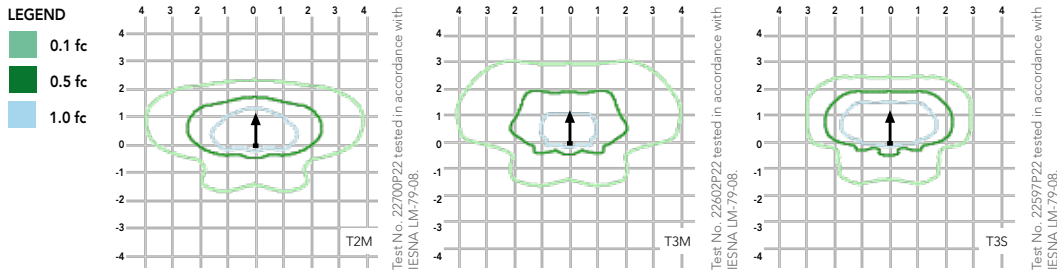

Distribution overlay comparison to 400W metal halide.

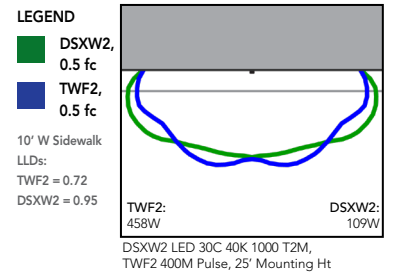

## FEATURES & SPECIFICATIONS

### INTENDED USE

The energy savings, long life and easy-to-install design of the D-Series Wall Size 2 make it the smart choice for building-mounted doorway and pathway illumination for nearly any facility.

### CONSTRUCTION

Two-piece die-cast aluminum housing has integral heat sink fins to optimize thermal management through conductive and convective cooling. Modular design allows for ease of maintenance. The LED driver is mounted to the door to thermally isolate it from the light engines for low operating temperature and long life. Housing is completely sealed against moisture and environmental contaminants (IP65).

### FINISH

Exterior parts are protected by a zinc-infused Super Durable TGIC thermoset powder coat finish that provides superior resistance to corrosion and weathering. A tightly controlled multi-stage process ensures a minimum 3 mils thickness for a finish that can withstand extreme climate changes without cracking or peeling. Available in textured and non-textured finishes.

### OPTICS

Precision-molded proprietary acrylic lenses provide multiple photometric distributions tailored specifically to building mounted applications. Light engines are available in 3000 K (70 min. CRI), 4000 K (70 min. CRI) or 5000 K (70 min. CRI) configurations.

### ELECTRICAL

Light engine(s) consist of 10 high-efficacy LEDs mounted to a metal-core circuit board to maximize heat dissipation and promote long life (L87/100,000 hrs at 25°C). Class 1 electronic drivers have a power factor >90%, THD <20%, and a minimum 2.5KV surge rating. When ordering the SPD option, a separate surge protection device is installed within the luminaire which meets a minimum Category C Low (per ANSI/IEEE C62.41.2).

### INSTALLATION

Included universal mounting bracket attaches securely to any 4" round or square outlet box for quick and easy installation. Luminaire has a slotted gasket wireway and attaches to the mounting bracket via corrosion-resistant screws.

### LISTINGS

CSA certified to U.S. and Canadian standards. Rated for -40°C minimum ambient.

DesignLights Consortium® (DLC) qualified product. Not all versions of this product may be DLC qualified. Please check the DLC Qualified Products List at [www.designlights.org](http://www.designlights.org) to confirm which versions are qualified.

### WARRANTY

Five-year limited warranty. Complete warranty terms located at [www.acuitybrands.com/CustomerResources/Terms\\_and\\_conditions.aspx](http://www.acuitybrands.com/CustomerResources/Terms_and_conditions.aspx).

**Note:** Actual performance may differ as a result of end-user environment and application. All values are design or typical values, measured under laboratory conditions at 25 °C. Specifications subject to change without notice.



# RADEAN Bollard

## LED Site Luminaire

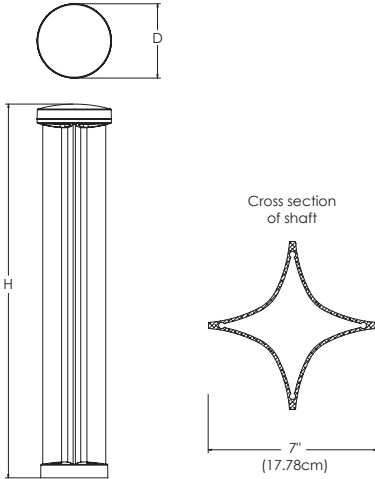

### Specifications

**Diameter:** D = 8.25" (20.96cm)  
**Height:** H = 41.5" Standard (105.41cm)  
**Weight (max):** 20lbs (9.07Kg)

Catalog Number

Notes

Type

Hit the Tab key or mouse over the page to see all interactive elements.

### Introduction

The Radean LED Bollard is an award-winning, energy-saving, long-life solution designed to perform the way a bollard should.

The Radean LED Bollard's rugged construction, durable finish and long-lasting LEDs will provide years of maintenance-free service.

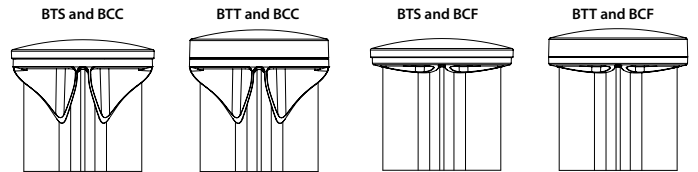

### Ordering Information

**EXAMPLE:** RADB LED P4 30K SYM MVOLT BTS BCCDNATXD DBLXD

RADB LED							
Series	Performance Package	Color temperature	Distribution	Voltage	Control options	Bollard top (required)	
RADB LED	P1	27K 2700 K	ASY Asymmetric <sup>2</sup>	MVOLT <sup>3</sup>	<b>Shipped installed</b> PE Photoelectric cell, button type <sup>4,5</sup> DMG 0-10V dimming driver (no controls) E7WH Emergency battery backup, Certified in CA Title 20 MAEDBS1 <sup>6,7</sup> FAO Field adjustable output <sup>5</sup> PIR Motion sensor Bi-level <sup>3,5,6,7</sup>	<b>Slim Top</b>	<b>Tall Top</b>
	P2	30K 3000 K	SYM Symmetric <sup>1</sup>	120		BTS Slim top, painted to match shaft <sup>5,8</sup>	BTT Tall top painted to match shaft <sup>8</sup>
	P3	35K 3500 K		208 <sup>3</sup>		BTSDWHXD Slim top, white <sup>5,8</sup>	BTDBLXD Tall top, black textured <sup>8</sup>
	P4	40K 4000 K		240 <sup>3</sup>		BTSDBLXD Slim top, black texture <sup>5,8</sup>	BTDBLXD Tall top, black <sup>8</sup>
	P5 <sup>1</sup>	50K 5000 K		277		BTSDBTXD Slim top, dark bronze textured <sup>5,8</sup>	BTDDBTXD Tall top, dark bronze textured <sup>8</sup>
				347		BTDDDBXD Tall top, dark bronze <sup>8</sup>	
				480		BTDDNATXD Tall top, natural aluminum textured <sup>8</sup>	
						BTDDNAXD Tall top, natural aluminum textured <sup>8</sup>	
						BTDDWHGXD Tall top, white textured <sup>8</sup>	
						BTDDWHXD Tall top, white <sup>8</sup>	
Bollard crown (required)					Other options		Finish (required)
<b>Deep Crown</b>			<b>Flat Crown</b>		H24 <sup>6,9</sup> 24" overall height	DDBXD Dark bronze	
BCC	Deep crown, painted to match shaft <sup>8</sup>		BCF	Flat crown, painted to match shaft <sup>8</sup>		DBLXD Black	
BCCDWHXD	Deep crown, white <sup>8</sup>		BCFDBLXD	Flat crown, black textured <sup>8</sup>		DNAXD Natural aluminum	
BCCDBLXD	Deep crown, black <sup>8</sup>		BCFDBLXD	Flat crown, black <sup>8</sup>		DWHXD White	
BCCDBLXD	Deep crown, black textured <sup>8</sup>		BCFDDBTXD	Flat crown, dark bronze textured <sup>8</sup>		DDBTXD Textured dark bronze	
BCCDDBTXD	Deep crown, dark bronze textured <sup>8</sup>		BCFDDBXD	Flat crown, dark bronze <sup>8</sup>		DBLXD Textured black	
BCCDDBXD	Deep crown, dark bronze <sup>8</sup>		BCFDNATXD	Flat crown, natural aluminum textured <sup>8</sup>		DNATXD Textured natural aluminum	
BCCDNATXD	Deep crown, natural aluminum textured <sup>8</sup>		BCFDNAXD	Flat crown, natural aluminum <sup>8</sup>		DWHGXD Textured white	
BCCDNAXD	Deep crown, natural aluminum <sup>8</sup>		BCFDWHGXD	Flat crown, white textured <sup>8</sup>			
BCCDWHGXD	Deep crown, white textured <sup>8</sup>		BCFDWHXD	Flat crown, white <sup>8</sup>			

### Accessories

Ordered and shipped separately.

RADBAB U	Anchor bolts (4)	RK1RADB BCKIT (FINISH) U	Base cover with bolt caps
RADBABC DDBXD U	Replacement anchor bolt covers (specify finish) (4)	RK1RADB EMTESTMAG U	Emergency test stylus

### NOTES

- P5 only available in SYM distribution.
- ASY has only two illuminated quadrants driven at higher drive currents to generate similar output as the SYM-4-quadrant product.
- PIR not available with 208V or 240V.
- PE only available with ASY.
- PE, PIR and FAO not available with BTS.

6 E7WH and PIR only available in full height. Not available with H24, H30 or H36.

7 PIR not available with E7WH.

8 Architectural and custom colors available (additional leadtimes and cost may apply).

9 42" Height is standard. H24, H30 and H36 have longer leadtimes.



COMMERCIAL OUTDOOR

One Lithonia Way • Conyers, Georgia 30012 • Phone: 1-800-705-SERV (7378) • [www.lithonia.com](http://www.lithonia.com)  
 © 2012-2019 Acuity Brands Lighting, Inc. All rights reserved.

## Options

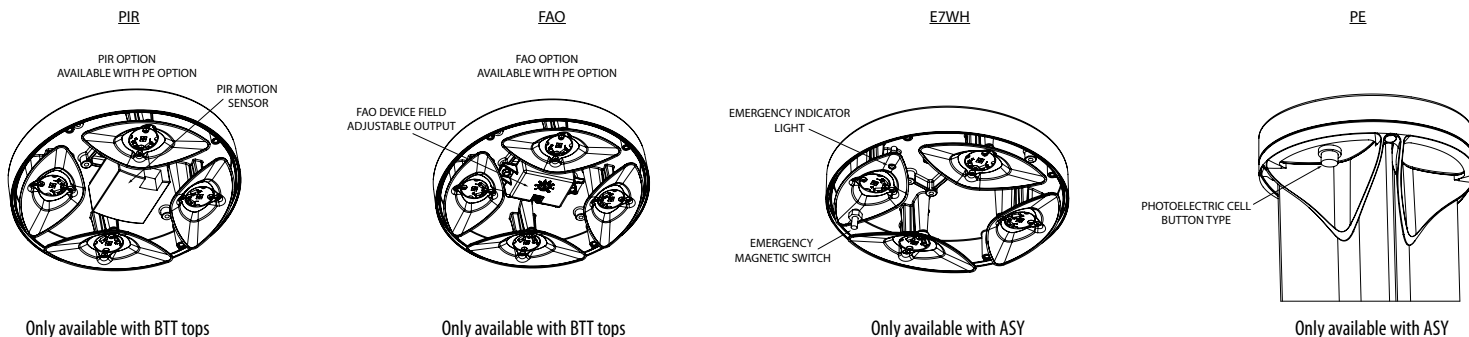

## Performance Data

Lumen values are from photometric tests performed in accordance with IESNA LM-79-08. Data is considered to be representative of the configurations shown, within the tolerances allowed by Lighting Facts. Actual performance may differ as a result of end-user environment and application. Actual wattage may differ by +/- 8% when operating between 120-480V +/- 10%.

### Performance Data DNAXD Finish\*

Light Engines	Performance Package	System Watts	2700K					3000K					3500K					4000K					5000K				
			Lumens	B	U	G	LPW	Lumens	B	U	G	LPW	Lumens	B	U	G	LPW	Lumens	B	U	G	LPW	Lumens	B	U	G	LPW
"Symmetric (4 light engines)"	P1	5	345	0	1	0	66	362	0	1	0	69	370	0	1	0	71	380	0	1	0	73	382	0	1	0	73
	P2	8	644	0	1	0	81	677	0	1	0	85	692	0	1	0	87	711	0	1	0	89	713	0	1	0	89
	P3	13	1036	1	1	0	77	1088	1	1	0	81	1112	1	1	0	83	1142	1	1	0	85	1146	1	1	0	85
	P4	19	1460	1	1	0	79	1534	1	1	0	83	1568	1	1	0	84	1610	1	1	0	87	1616	1	1	0	87
	P5	32	2314	1	1	0	72	2430	1	1	0	75	2484	1	1	0	77	2551	1	1	0	79	2561	1	1	0	79
"Asymmetric (2 light engines)"	P1	5	312	0	1	0	60	328	0	1	0	63	335	0	1	0	64	344	0	1	0	66	346	0	1	0	66
	P2	8	584	0	1	0	73	613	0	1	0	77	627	0	1	0	78	644	0	1	0	81	646	0	1	0	81
	P3	13	938	0	1	0	70	985	0	1	0	73	1007	0	1	0	75	1035	0	1	0	77	1038	0	1	0	77
	P4	19	1323	0	1	0	71	1390	0	1	0	75	1420	0	1	0	76	1459	0	1	0	78	1464	0	1	0	79

\*Note: Lumen output varies based on finish. Silver color shown, for black (worst) or white (best) photometry, see specific photometric files downloadable from [www.acuitybrands.com](http://www.acuitybrands.com)

### Projected LED Lumen Maintenance

Data references the extrapolated performance projections for the platforms noted in a 25°C ambient, based on 10,000 hours of LED testing (tested per IESNA LM-80-08 and projected per IESNA TM-21-11).

To calculate LLF, use the lumen maintenance factor that corresponds to the desired number of operating hours below. For other lumen maintenance values, contact factory.

	Projected LED Lumen Maintenance			
	25,000	50,000	75,000	100,000
P1	0.94	0.89	0.85	0.80
P2	0.94	0.89	0.85	0.80
P3	0.94	0.89	0.85	0.80
P4	0.94	0.89	0.85	0.80
P5	0.94	0.89	0.85	0.80

### Lumen Ambient Temperature (LAT) Multipliers

Use these factors to determine relative lumen output for average temperatures from 0-40°C (32-104°F).

Ambient	LAT Factor	
0	32°F	1.03
5	41°F	1.03
10	50°F	1.02
15	59°F	1.01
20	68°F	1.01
25	77°F	1
30	86°F	0.99
35	95°F	0.99
40	104°F	0.98

### Electrical Load

	Current (Amp)						Current (Amp)			
	Watts @120V (W)	Watts @277V (W)	@120V (A)	@208V (A)	@240V (A)	@277V (A)	Watts (@347V)	Watts (@480V)	@347V (A)	@480V (A)
P1 ASY	5	6	0.0445	0.0299	0.0276	0.0262	10	10	0.0443	0.0319
P2 ASY	9	10	0.0751	0.0471	0.0429	0.0399	14	14	0.0505	0.0364
P3 ASY	14	15	0.1147	0.0699	0.0627	0.0571	18	18	0.0611	0.0441
P4 ASY	19	19	0.1586	0.0928	0.0819	0.0735	23	23	0.0709	0.0513
P1 SYM	5	6	0.0444	0.0301	0.0279	0.0265	9	9	0.0441	0.0319
P2 SYM	9	10	0.0734	0.0461	0.0421	0.0391	13	13	0.0502	0.0363
P3 SYM	13	14	0.112	0.067	0.0598	0.0544	18	18	0.0602	0.0435
P4 SYM	18	19	0.1535	0.0902	0.0796	0.0713	22	22	0.0691	0.0499
P5 SYM	31	31	0.2597	0.1527	0.1326	0.1149	35	36	0.1079	0.079





Isofootcandle plots for the RADB. Distances are in units of mounting height (3.5').

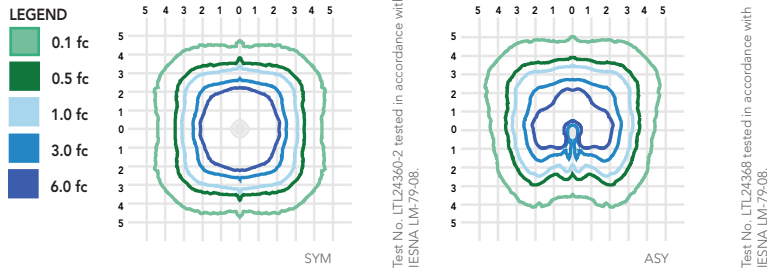

## FEATURES & SPECIFICATIONS

### INTENDED USE

The rugged construction and maintenance-free performance of the Radean LED Bollard is ideal for illuminating building entryways, walking paths and pedestrian plazas, as well as any other location requiring a low-mounting-height light source.

### CONSTRUCTION

One-piece extruded aluminum shaft with thick side walls for extreme durability, and die-cast reflector and top cap. Four 3/8" x 16" anchor bolts with double nuts and washers and 5-2/3" max. bolt circle template ensure stability. Overall height is 42" standard.

### FINISH

Exterior parts are protected by a zinc-infused super durable TGIC thermoset powder coat finish that provides superior resistance to corrosion and weathering for maximum retention of gloss and luster. A tightly controlled multi-stage process ensures a minimum 3-mil thickness for a finish that can withstand the elements without cracking or peeling. Available in both textured and non-textured finishes.

### OPTICS

Two optical distributions are available: symmetrical and asymmetrical. IP66 sealed LED light engine provides smoothly graduated illumination. Light engines are available in 2700K, 3000K, 3500K, 4000K or 5000K.

### ELECTRICAL

Light engines consist of high-efficacy LEDs mounted to metal-core circuit boards to maximize heat dissipation and promote long life (L80/100,000 hours at P5 at 25°C). Class 2 electronic drivers are designed for an expected life of 100,000 hours with < 1% failure rate. Electrical components are mounted on a removable power tray.

### LISTINGS

CSA certified to U.S. and Canadian standards. Light engines are IP66 rated. Rated for -40°C minimum ambient. Emergency battery backup rated for -10°C minimum ambient. International Dark-Sky Association (IDA) Fixture Seal of Approval (FSA) is available for all products on this page utilizing 3000K color or less.

### WARRANTY

Five-year limited warranty. Complete warranty terms located at: [www.acuitybrands.com/CustomerResources/Terms\\_and\\_conditions.aspx](http://www.acuitybrands.com/CustomerResources/Terms_and_conditions.aspx).

**Note:** Actual performance may differ as a result of end-user environment and application and color. All values are design or typical values, measured under laboratory conditions at 25 °C. Specifications subject to change without notice.

**FINE**

Parkway Woods

# Signage System Design

DRAFT ONLY - Collaboration with MDG & Atwell

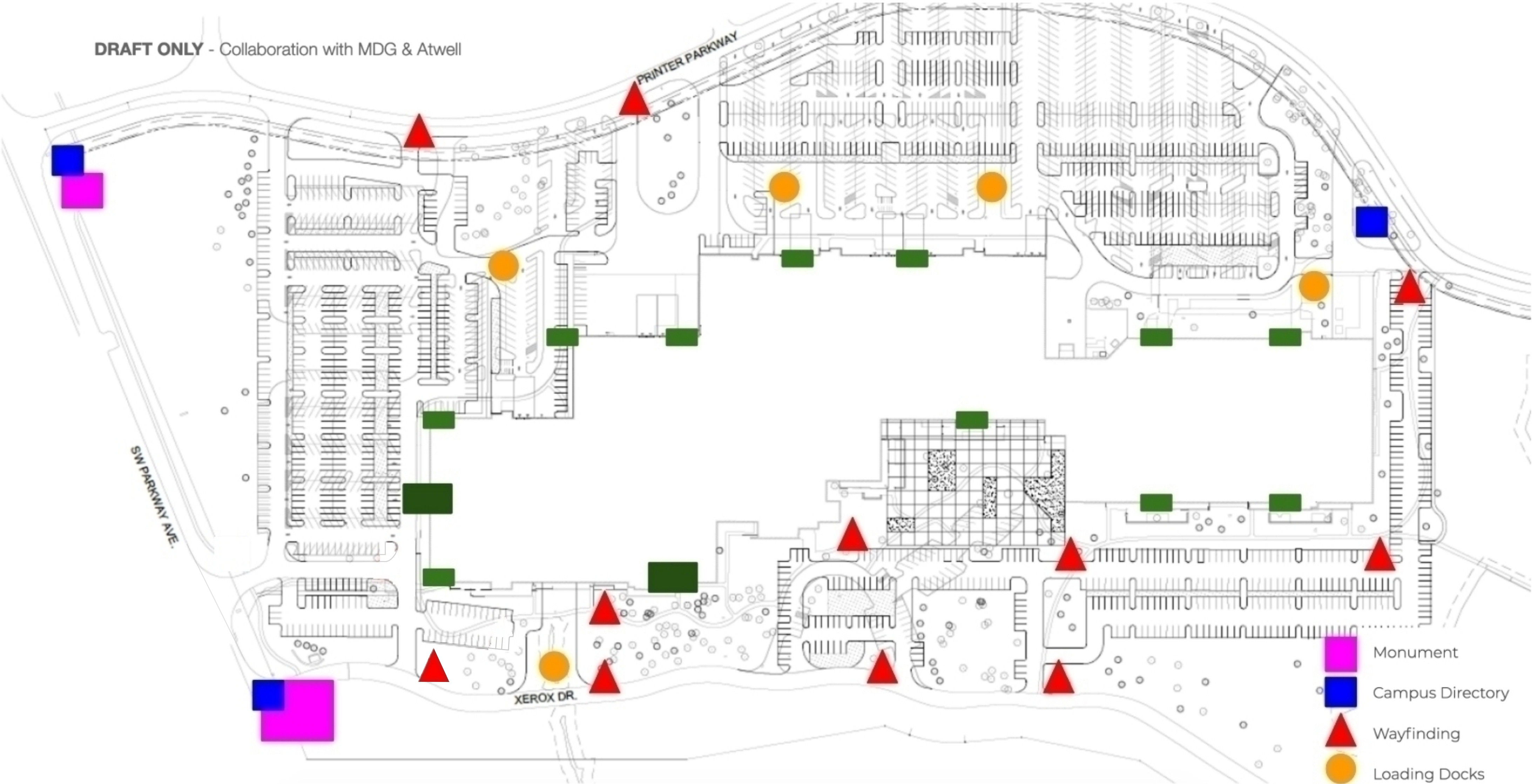

- Monument
- Campus Directory
- Wayfinding
- Loading Docks
- Building Signs

MONUMENT +  
DIRECTORY

STEEL BACKER  
WITH WHITE,  
EDGE-LIT  
TYPOGRAPHY

20' - 34'

GROUND LEVEL  
UP LIGHTS

3.5'

26600

PARKWAY WOODS

ADDRESS  
ETCHED + PRINTED

TYPOGRAPHY  
RELIEF 4"

1'

WOOD-LOOK  
METAL MATCH  
TO LOUNGE  
CEILING

3D SYSTEMS  
DEALER SPIKE  
XEROX

4' X 6'

SATIN  
FINISH  
STEEL

FRONT VIEW

1'

15'

2'

SIDE

3D SYSTEMS  
DEALER SPIKE  
XEROX

PANTONE  
447C

REVERSE

26600

PARKWAY WOODS

PANTONE  
425C

SIDE

3D SYSTEMS

DEALER SPIKE

XEROX

FUTURE TENANT

FUTURE TENANT

FUTURE TENANT

FUTURE TENANT  
LONGER NAME

FUTURE TENANT

FUTURE TENANT

4' X 6'

MODULAR  
MARQUEE SYSTEM

TENANT NAMES ETCHED  
& PRINTED ON SLIDING  
METAL SLATS

TENANTS OVER 15K SF  
FEATURED AT TOP

SATIN FINISH  
STEEL

GROUND LEVEL  
UP LIGHTS

3D SYSTEMS

DEALER SPIKE

XEROX

FUTURE TENANT

FUTURE TENANT

FUTURE TENANT

FUTURE TENANT  
LONGER NAME

FUTURE TENANT

FUTURE TENANT

REVERSE

6"

SECONDARY  
MONUMENT

TYPOGRAPHY  
RELIEF 1.5"

PANTONE  
425C

7'

PARKWAY WOODS

3D SYSTEMS

DEALER SPIKE

XEROX

FUTURE TENANT

FUTURE TENANT

FUTURE TENANT

FUTURE TENANT  
LONGER NAME

FUTURE TENANT

FUTURE TENANT

WOOD-LOOK  
METAL

PANTONE  
447C

4' X 6'

3D SYSTEMS

DEALER SPIKE

XEROX

FUTURE TENANT

FUTURE TENANT

FUTURE TENANT

FUTURE TENANT  
LONGER NAME

FUTURE TENANT

FUTURE TENANT

PARKWAY WOODS

REVERSE

1'

6"

1'

## TENANT TEMPLATE

MAXIMUM ALLOWED  
SIGN AREA IS BASED  
ON LENGTH OF  
BUILDING OR LENGTH  
OF SPECIFIC TENANT  
SPACE FACADE

CLEAR SPACE  
AROUND ARTWORK  
DETERMINED BY  
CALCULATING 10% OF  
HEIGHT OR WIDTH,  
WHICHEVER IS  
GREATER

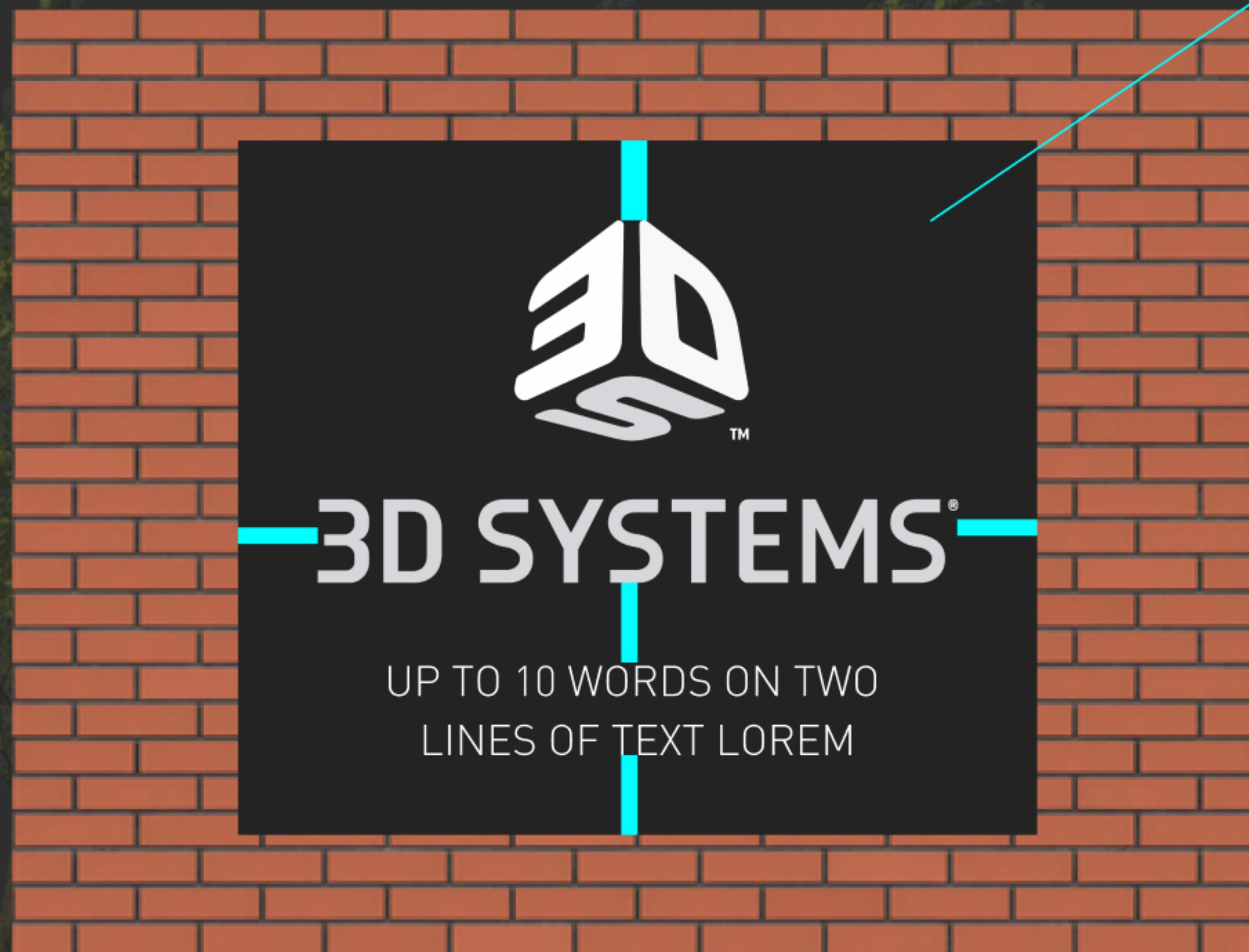

PANTONE 447C

SATIN FINISH  
STEEL

WHITE DIMENSIONAL  
ARTWORK - RELIEF 1.5"

TEXT OPTIONAL  
ETCHED &  
PRINTED WHITE  
TYPEFACE: DIN LIGHT

PROPERTY DIRECTIONAL

ALTERNATE: BOLDER TYPE

SINGLE CALL OUT



LIST

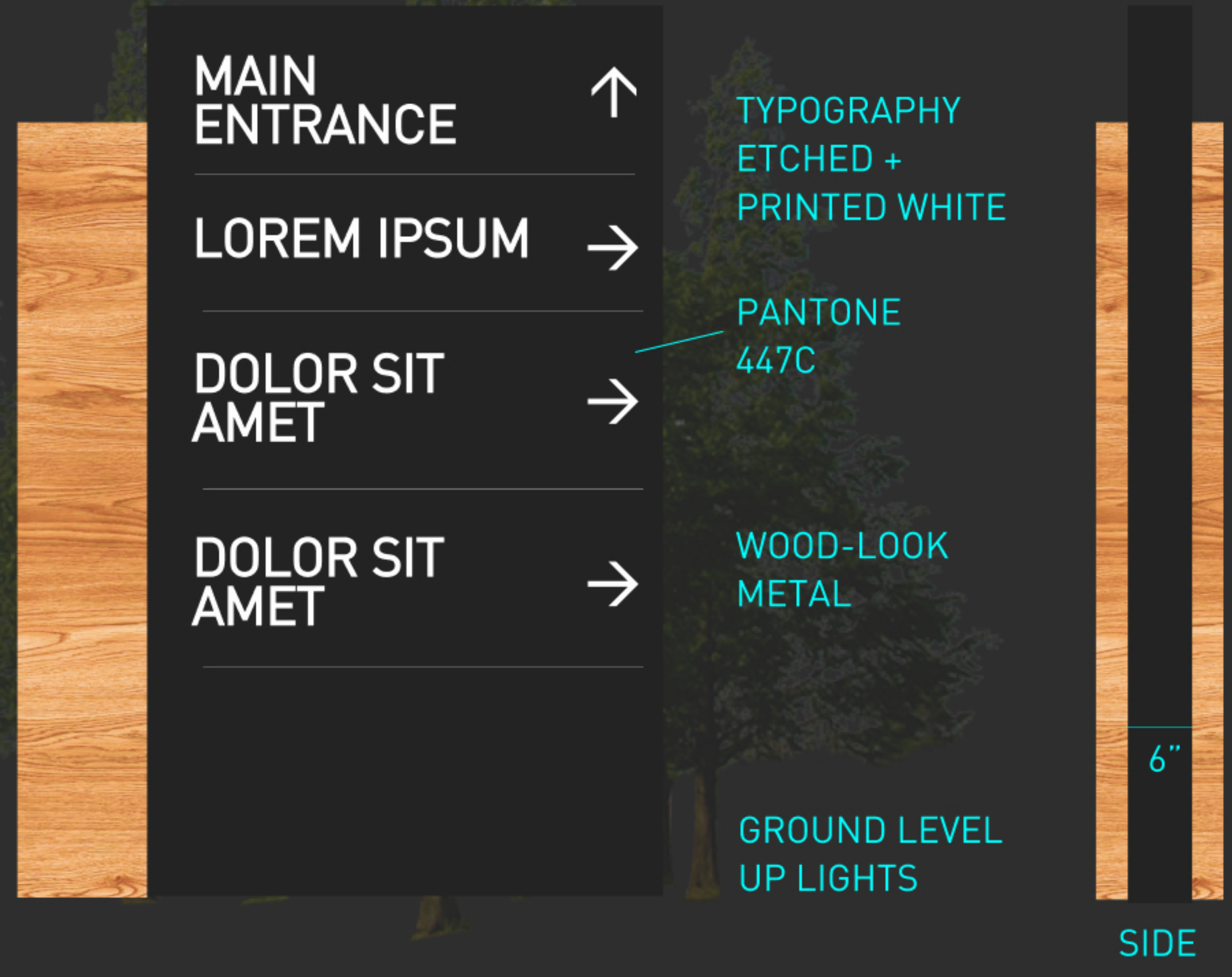



LOADING DOCK ID

08

4'

MOUNTED DIMENSIONAL  
NUMBERING RELIEF: 1.5"



LOADING DOCK INFORMATION



TRUCKS  
ONLY

PANTONE  
447C

TYPOGRAPHY  
ETCHED &  
PRINTED WHITE

FLEXIBLE  
HEIGHT

WOOD-LOOK  
METAL

GROUND LEVEL  
UP LIGHTS

1'

1'

FULL SYSTEM

26600

PARKWAY WOODS

MONUMENT & DIRECTORY

3D SYSTEMS  
DEALER SPIKE  
XEROX



LOADING DOCK ID

TRUCKS  
ONLY

LOADING DOCK  
INFORMATION



TENANT TEMPLATE

PARKWAY WOODS

3D SYSTEMS  
DEALER SPIKE  
XEROX  
FUTURE TENANT FUTURE TENANT  
FUTURE TENANT FUTURE TENANT LONGER NAME  
FUTURE TENANT FUTURE TENANT

SECONDARY MONUMENT

3D  
SYSTEMS

PROPERTY DIRECTIONAL  
SINGLE

MAIN ENTRANCE ↑  
LOREM IPSUM →  
DOLOR SIT AMET →  
DOLOR SIT AMET →

PROPERTY DIRECTIONAL  
LIST

## Kevin Apperson

---

**To:** Kevin Apperson  
**Subject:** Parkway Wood Business Park - parking and truck accessibility and loading

**From:** Steven Klein <[steven.klein@kidder.com](mailto:steven.klein@kidder.com)>  
**Sent:** Tuesday, May 12, 2020 9:13 AM  
**To:** Matt Morvai <[mmorvai@skbcos.com](mailto:mmorvai@skbcos.com)>  
**Cc:** Peter Stalick <[peter.stalick@kidder.com](mailto:peter.stalick@kidder.com)>  
**Subject:** Parkway Wood Business Park - parking and truck accessibility and loading

Good morning Matt,

We wanted to share our thoughts on repositioning the Parkway Woods Business Park for light manufacturing and assembly industrial and technology tenants. For these types of businesses, we have found that there are at least two components of the operation and include, but are not limited to the following:

- Production – this is the area where products are manufactured and assembled. Figure 50% plus of the overall area.
- Warehousing – generally there is an area that is for receiving and storing raw materials and parts and a shipping area where finished product is stored and then shipped out. Figure up to 25%.
- R&D – this could be either an area that looks like an open office area or an open production area that may include different infrastructure than other areas, like increased electrical service, HVAC, plumbing. Figure 10% to 20%
- Office area – We expect that the office area for the types of businesses we will be attracting to the project will need 25% to 50% build out with mostly an open office concept.

One of the most important aspects of repositioning the property for these types of businesses, is the parking requirements. Generally, we see a need for about 4 stalls per 1,000 SF of office and R&D, 2 stalls per 1,000 SF of production and about 1 stall per 1,000 SF of warehouse area.

Because there is a warehousing and production component to this business there is an obvious need for the building to have dock high and drive in loading for receiving and shipping goods. It is very important that there is easy access and staging area to maneuver large 53' trailers to the designated loading areas. In our opinion we see this working out best on the north side of the building given that it allows for the most direct route off Parkway and Printer Parkway, but having truck access on the south side will be essential to service the loading dock doors on that side of the building. Additionally, on the north side of the building there is more open area that can be used to develop the staging, turning and maneuvering area needed for the truck and trailer circulation.

Having the majority of loading on the north side of the building then lends the south side of the building for multiple storefronts for multiple tenant entries. The south side of the building allows abundant glass lines for the office users and the undeveloped land area will allow for development of additional parking needed for the larger number of employees who will use the office area. Again, while the focus of loading is primarily on the northside, it will reduce the amount needed on the south side of the building. Having as much parking as possible close to the entries is important to a successful project.

Please let us know if you have any questions.

Thank you, Steven

**Steven Klein**

Managing Director

**KIDDER MATHEWS**

101 SW Main St., Suite 1200, Portland, OR 97204

T 503.221.2260 | C 503.318.0916

[steven.klein@kidder.com](mailto:steven.klein@kidder.com) | [kidder.com](http://kidder.com)

[download vcard](#) | [view profile](#)

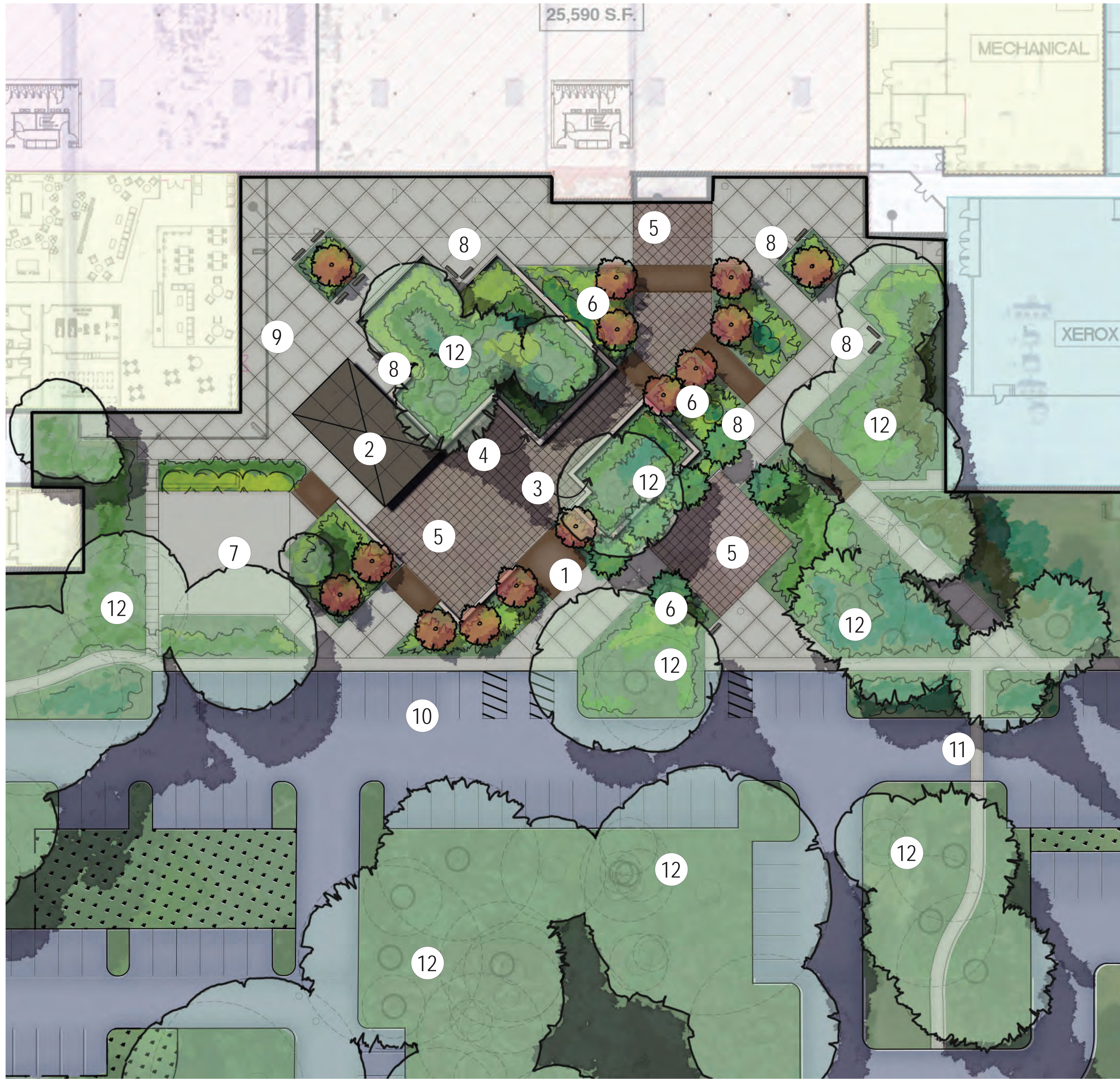

## LEGEND

1. Perforated Metal Walk Bridges
2. Pergola
3. Raised Planter
4. Seat Wall
5. Enhanced Pavement
6. Bio-Retention
7. Basketball Court
8. Seating Nook
9. Employee Lounge Area
10. Vehicular Park
11. Pedestrian Access / Crosswalks
12. Existing Trees to Remain



## PARKWAY WOODS ENTRY PLAZA

Wilsonville, OR  
 April 22, 2020  
 # 20000155  
 Atwell

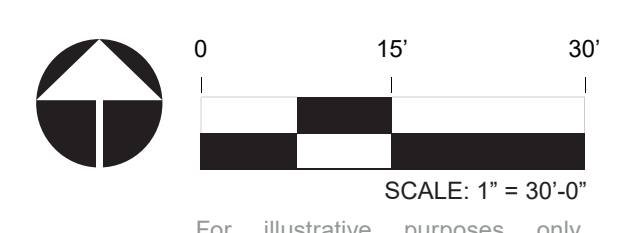

For illustrative purposes only.  
 Subject to change without notice.

# Memo

---

**TO:** Philip Bradford, Associate Planner, City of Wilsonville

**FROM:** Atwell, LLC

**DATE:** 10/12/2020

**RE:** Evolution of Tree Preservation Efforts

---

The Parkway Woods proposed development project has undergone a number of site plan iterations in order to preserve the greatest number of trees and still meet the projects objectives. With each iteration, the percentage of Oregon White Oaks and Ponderosa Pines being preserved grew respectively. Below is a summary of the tree preservation efforts associated with each of the site plan iterations.

Iteration	Date	Percentage of Oregon White Oak Preservation	Percentage of Ponderosa Pine Preservation	Overall Tree Preservation Percentage
#1	January 16, 2020	15.1%	23.9%	22.8%
#2	February 6, 2020	25.3%	30.7%	30.9%
#3	March 11, 2020	50.6%	54.5%	43.6%
#4	April 9, 2020	53.6%	62.5%	46.1%
#5	May 14, 2020	56.0%	65.9%	48.9%
#6	July 7, 2020	57.2%	69.3%	48.4%

Based on the most recent project iteration (i.e. Iteration #6), the proposed Tree Protection and Removal Plan identified the removal of 312 trees, 10 of which are less than 6" in size. This includes the removal of 98 Oregon White Oak and Ponderosa Pines. Below is a breakdown of the condition of each of tree that is proposed for removal.

	Good	Fair	Poor	Very Poor
Oregon White Oak	21	15	35	0
Ponderosa Pine	15	9	2	1
<b>Total</b>	<b>36</b>	<b>24</b>	<b>37</b>	<b>1</b>



The City's code requires the removed trees to be replaced on a basis of one (1) tree replanted for each tree removed. Based on this, 302 will be mitigated for.

The proposed landscape plans identify the planting of 462 trees, five of which are Ponderosa Pines and six are Oregon White Oaks.

Beginning on the following page is a summary of each of the major iterations of the site plan.



### Site Plan - Version #1 (Dated 1/16/2020)

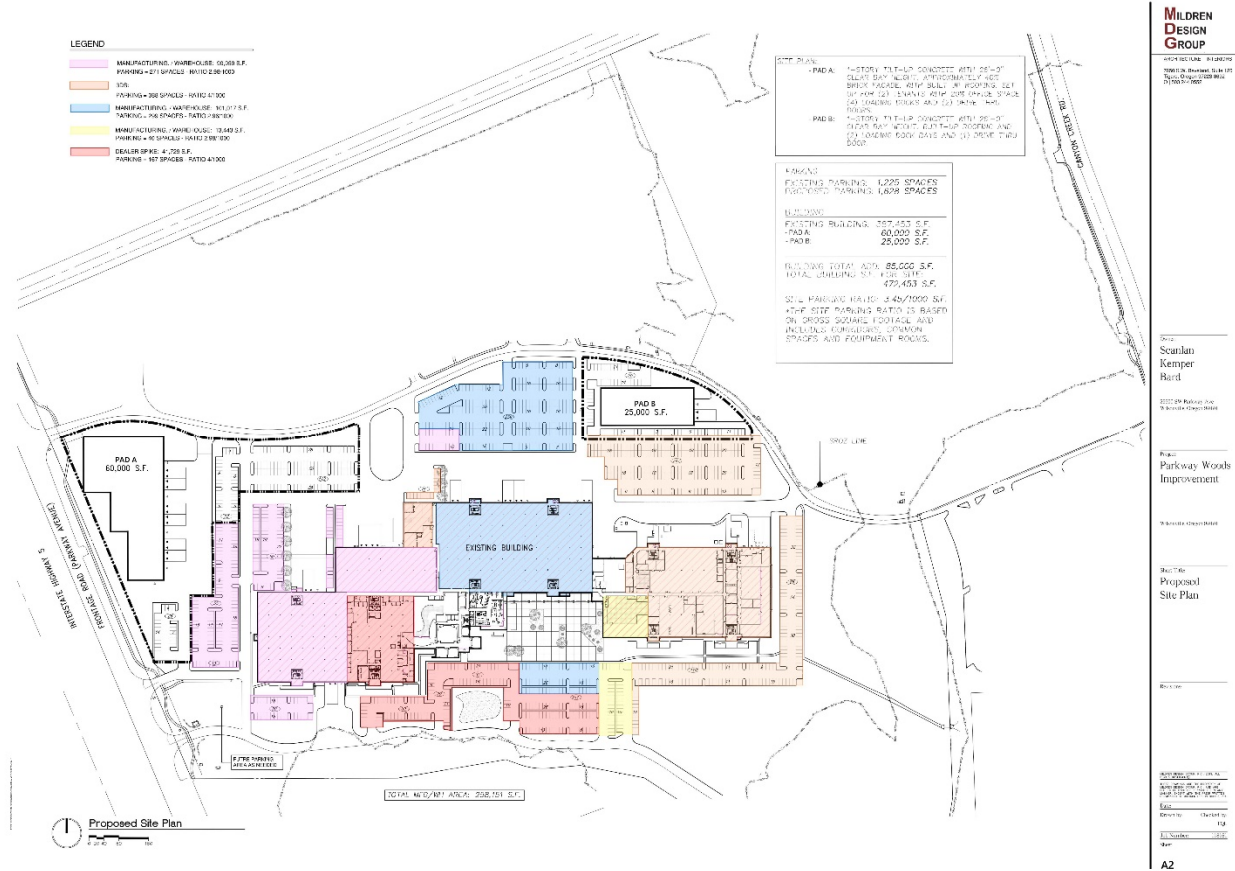

	Total Number of Trees (Per Arborist Report)	Number of Tree Identified for Preservation	Number of Trees Proposed for Removal	Preservation Percentage
Oregon White Oaks	166	25	141	15.1%
Ponderosa Pines	88	21	67	23.9%
Other (Refer to Arborist Report for Specific Species)	351	92	259	26.2%
<b>Totals</b>	<b>605</b>	<b>138</b>	<b>467</b>	<b>22.8%</b>

# Site Plan - Version #2 (Dated 2/6/2020)

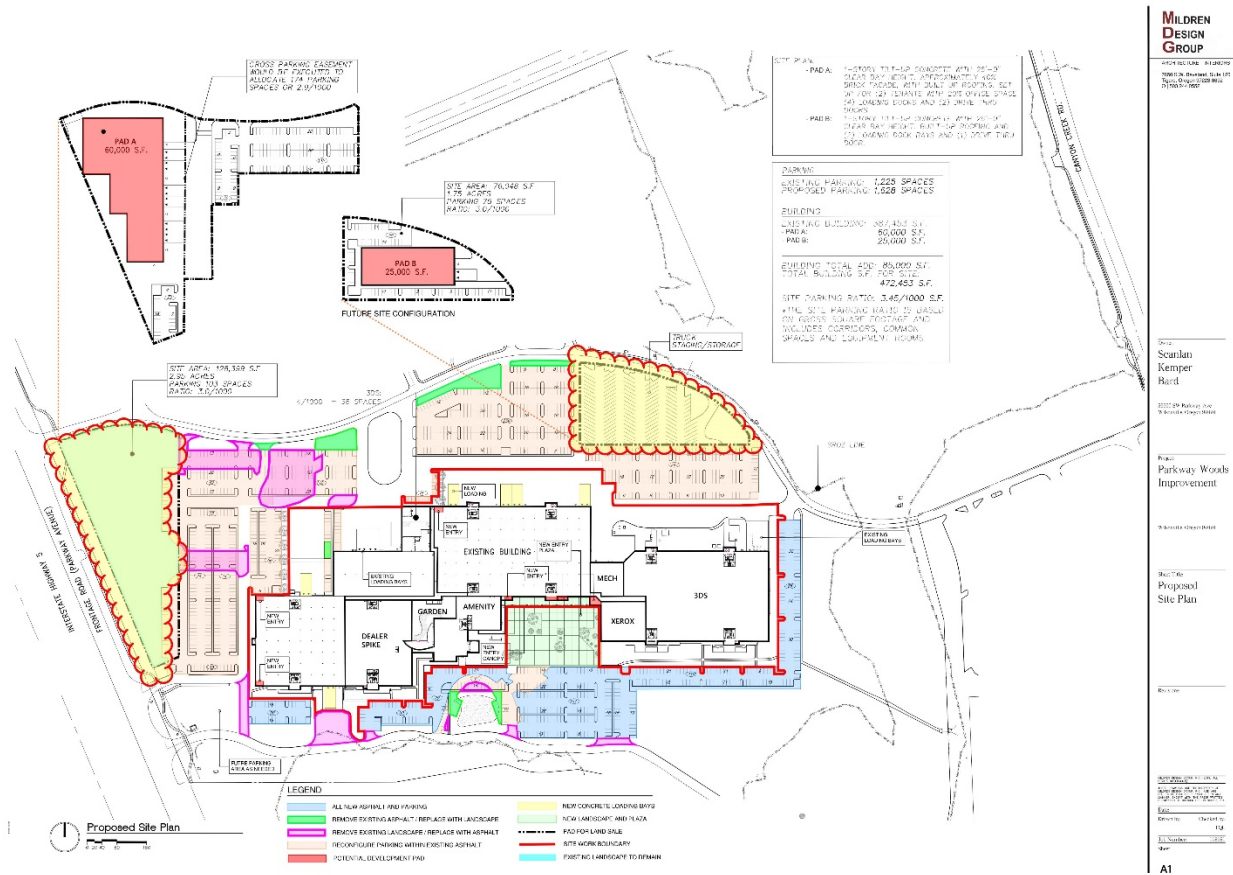

## Design Modifications:

- No development in areas identified as Pad A or Pad B.

**Site Plan - Version #3 (Dated 3/11/2020)**



	<b>Total Number of Trees (Per Arborist Report)</b>	<b>Number of Tree Identified for Preservation</b>	<b>Number of Trees Proposed for Removal</b>	<b>Preservation Percentage</b>
Oregon White Oaks	166	84	82	50.6%
Ponderosa Pines	88	48	40	54.5%
Other ( <i>Refer to Arborist Report for Specific Species</i> )	351	132	219	37.6%
<b>Totals</b>	<b>605</b>	<b>264</b>	<b>341</b>	<b>43.6%</b>

Design Modifications:

- Reconfigured surface parking areas the northwest and south portions of the site.
- Modified plaza design to preserve additional trees.

Site Plan - Version #4 (Dated 4/9/2020)

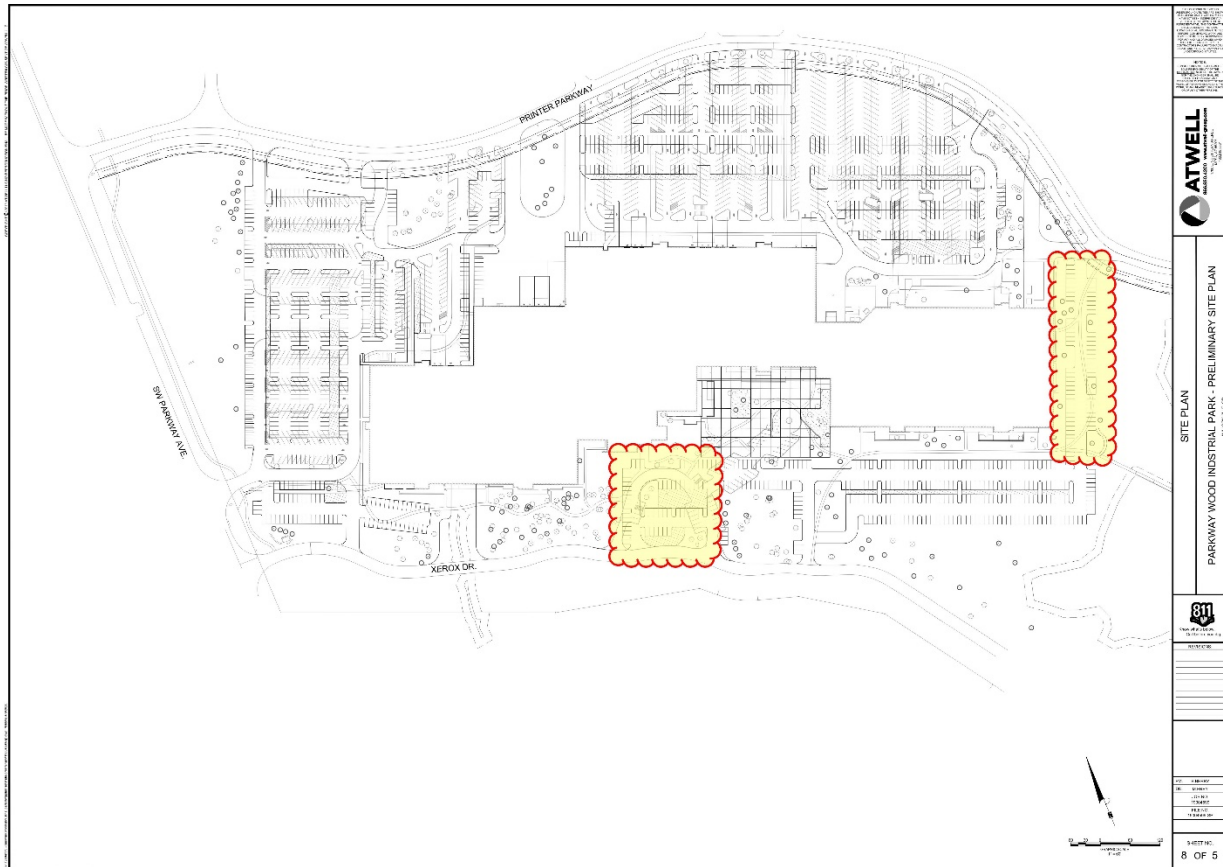

	Total Number of Trees (Per Arborist Report)	Number of Tree Identified for Preservation	Number of Trees Proposed for Removal	Preservation Percentage
Oregon White Oaks	166	89	77	53.6%
Ponderosa Pines	88	55	33	62.5%
Other (Refer to Arborist Report for Specific Species)	351	135	216	38.4%
<b>Totals</b>	<b>605</b>	<b>279</b>	<b>326</b>	<b>46.1%</b>

Design Modifications:

- Reconfigured surface parking areas in the south portion of the site.
- Modified planter islands to preserve additional trees.

Site Plan - Version #5 (Dated 5/14/2020)



	Total Number of Trees (Per Arborist Report)	Number of Tree Identified for Preservation	Number of Trees Proposed for Removal	Preservation Percentage
Oregon White Oaks	166	93	73	56.0%
Ponderosa Pines	88	58	30	65.9%
Other (Refer to Arborist Report for Specific Species)	351	145	206	41.3%
<b>Totals</b>	<b>605</b>	<b>296</b>	<b>309</b>	<b>48.9%</b>

Design Modifications:

- Reconfigured surface parking areas in the northwest and south portions of the site.
- Modified planter islands to preserve additional trees.

Site Plan - Version #6 (Dated 7/7/2020)



	Total Number of Trees (Per Arborist Report)	Number of Tree Identified for Preservation	Number of Trees Proposed for Removal	Preservation Percentage
Oregon White Oaks	166	95	71	57.2%
Ponderosa Pine	88	61	27	69.3%
Other (Refer to Arborist Report for Specific Species)	351	137	214	39.0%
<b>Totals</b>	<b>605</b>	<b>293</b>	<b>(1) 312</b>	<b>48.4%</b>

(1) 312 trees are located within the development area; however, 10 of the trees are less than 6" DBH

Design Modifications:

- Reconfigured entry and surface parking areas in the west portions of the site.
- Modified planter islands to preserve additional trees.



29799 SW Town Center Loop E, Wilsonville, OR 97070  
Phone: 503.682.4960 Fax: 503.682.7025  
Web: [www.ci.wilsonville.or.us](http://www.ci.wilsonville.or.us)

**Planning Division**  
**Development Permit Application**

Final action on development application or zone change is required within 120 days in accordance with provisions of ORS 227.175

A pre application conference is normally required prior to submittal of an application. Please visit the City's website for submittal requirements

Pre-Application Meeting Date: 2/20/20

**Incomplete applications will not be scheduled for public hearing until all of the required materials are submitted.**

**Applicant:**

Name: Matt Morvai  
Company: PWII Owner, LLC  
Mailing Address: 222 SW Columbia Street, Ste #700  
City, State, Zip: Portland, OR 97201  
Phone: 503.783.6260 Fax: \_\_\_\_\_  
E-mail: mmorvai@skbcos.com

**Authorized Representative:**

Name: Kevin Apperson  
Company: Atwell, LLC  
Mailing Address: 9755 SW Barnes Road, Suite #150  
City, State, Zip: Portland, OR 97225  
Phone: 971.334.8964 Fax: \_\_\_\_\_  
E-mail: kapperson@atwell-group.com

**Property Owner:**

Name: Todd Gooding  
Company: PWII Owner, LLC  
Mailing Address: 222 SW Columbia Street, Ste # 700  
City, State, Zip: Portland, OR 97201  
Phone: 503-220-2600 Fax: \_\_\_\_\_  
E-mail: tgooding@skbcos.com

**Property Owner's Signature:**

  
Printed Name: Todd Gooding Date: 5/11/20

**Applicant's Signature:** (If different from Property Owner)

  
Printed Name: Matt Morvai Date: 5/11/20

**Site Location and Description:**

Project Address if Available: 26600 SW Parkway Avenue Suite/Unit \_\_\_\_\_  
Project Location: 26600 SW Parkway Avenue  
Tax Map #(s): T2S R1W Sect. 12 Tax Lot #(s): 511, 581 & 591 County:  Washington  Clackamas

**Request:** Stage II Final Plan/Site Design Review for building modifications (i.e. addition of loading doors/windows) and site improvements (i.e. parking lot reconfiguration/landscaping); Tree Removal (Type C); SROZ to fill small wetland; and Sign Master Plan for an overall campus signage plan.

**Project Type:** Class I  Class II  Class III

Residential  Commercial  Industrial  Other: \_\_\_\_\_

**Application Type(s):**

- |  |   |  |   |
|--|---|--|---|
| <input type="checkbox"/> Annexation                          | <input type="checkbox"/> Appeal                     | <input type="checkbox"/> Comp Plan Map Amend | <input type="checkbox"/> Parks Plan Review              |
| <input type="checkbox"/> Final Plat                          | <input type="checkbox"/> Major Partition            | <input type="checkbox"/> Minor Partition     | <input type="checkbox"/> Request to Modify Conditions   |
| <input type="checkbox"/> Plan Amendment                      | <input type="checkbox"/> Planned Development        | <input type="checkbox"/> Preliminary Plat    | <input checked="" type="checkbox"/> Site Design Review  |
| <input type="checkbox"/> Request for Special Meeting         | <input type="checkbox"/> Request for Time Extension | <input checked="" type="checkbox"/> Signs    | <input checked="" type="checkbox"/> Stage II Final Plan |
| <input checked="" type="checkbox"/> SROZ/SRIR Review         | <input type="checkbox"/> Staff Interpretation       | <input type="checkbox"/> Stage I Master Plan | <input type="checkbox"/> Variance                       |
| <input checked="" type="checkbox"/> Type C Tree Removal Plan | <input type="checkbox"/> Tree Permit (B or C)       | <input type="checkbox"/> Temporary Use       | <input type="checkbox"/> Other (describe) _____         |
| <input type="checkbox"/> Villebois SAP                       | <input type="checkbox"/> Villebois PDP              | <input type="checkbox"/> Villebois FDP       |   |
| <input type="checkbox"/> Zone Map Amendment                  | <input type="checkbox"/> Waiver(s)                  | <input type="checkbox"/> Conditional Use     |   |

Planning Division Fees Effective February 28, 2020

Fee Type	Fee
<b>Administrative Review</b>	
Class I	\$355
Class II	\$1,544
<b>Annexation</b>	
	\$4,631 + Metro annexation fee
	Single tax lot less than 1 acre: \$150
	One to 5 acre: \$250
	Five to 40 acres: \$300
	More than 40 acres: \$400
<b>Appeals</b>	
Administrative Decision or Interpretation	\$504
DRB or Planning Commission Action	\$3,676
Referee Decision (expedited land division)	\$1,209
<b>Architectural Review (Villebois)</b>	
Single Family	\$403
Multi-family per Unit	\$101
<b>Change of non-conforming use</b>	
	\$1,072
<b>Comprehensive Plan Amendment</b>	
Legislative text	\$10,073 + \$902 if BM 56 notice is required
Legislative map	\$6,790 + \$902 if BM 56 notice is required
Quasi-judicial map	\$3,305 + \$902 if BM 56 notice is required
<b>Conditional Use Permit</b>	
Accessory Use to SFD in Willamette River Greenway	\$1,814
All others	\$2,684
<b>Erosion Control Inspection Fee</b>	
Base	\$424
Per additional inspection	\$80
<b>Expedited Land Division</b>	
Villebois	Double the regular fee
Under ORS 197	\$1,209 + \$21/lot
<b>Final Plat Review</b>	
Partition	\$1,225
Subdivision	\$2,631
<b>Parks Plan Review Fee</b>	
	\$2,769



Planning Division Fees Effective February 28, 2020

Fee Type	Fee
<b>Planned Unit Development</b>	
Stage I	
Any Use	\$2,249
Modified	\$1,262
Villebois SAP Modification	\$1,613
Stage II	
< 2 gross acres	\$8,302
2 to 10 gross acres	\$10,381
> 10 gross acres	\$12,455
Modified	\$2,992
Villebois PDP	Base fee \$2,419; <b>Plus</b> \$302/net acre for all sites > 2 acres; <b>Plus</b> \$21/lot
<b>Preapplication Conference</b>	
Residential < 10 lots/units	\$424
Other Signs only	\$202
All others	\$886
<b>Recorded Matter – Per Document</b>	
Document Fee – Per Legal Document	\$355
<b>Requested transcript of meeting</b>	
	Billed to the applicant at the City's current transcriptionist's rate
<b>Reinspection fee - when applicant fails to pass initial planning inspection</b>	
	Billed at hourly staff rate
<b>Request for special meeting</b>	
Staff	\$302
DRB or Planning Commission	\$2,748
City Council	\$3,029
<b>Request for Time Extension</b>	
Administrative	\$101
DRB Review: First Extension	\$504
DRB Review: Second Extension	\$1,008
DRB Review: Third Extension	\$2,016
<b>Request to Modify Conditions of Approval</b>	
Administrative	\$981
DRB Review	\$2,530
City Council	\$3,586
<b>Review of Bldg Permit Application</b>	
Residential – Deck/Garage/Carport, etc.	\$276
All other Residential	\$339
All other	\$1,003 or 0.0081% of value of bldg, whichever is greater, not to exceed \$15,123

Adopted by Resolution 2620.

Note: Each fee component stands alone and may require multiple components

Planning Division Fees Effective February 28, 2020

Fee Type	Fee
<b>SROZ Review</b>	
Verification of Boundary	
Abbreviated	\$419
Standard	\$515
<b>SRIR Review</b>	
Abbreviated	\$594
Standard	\$1,687
Review Mitigation Monitoring Report	
	\$504
<b>Signs Permits and Review (Except Temporary Signs)</b>	
Class I Sign Permit	\$202
Minor Adjustment as Part of Class I Sign Permit	\$101
Class II Sign Permit	\$573
Class III Sign Permit	\$849
Master Sign Plan	\$1,422
<b>Site Design Review</b>	
	Base fee \$2,249; <b>Plus</b> \$1,607 per occupied building subject to review <b>Plus</b> \$1,607 per 5 acres, or portion thereof, of net site area (excludes single-family lots)
<b>Small Wireless Facility in Public Right-of-Way (see Resolution 2720)</b>	
	Deposit when submitting application: -Planning Review Fee for up to 5 locations (same as Class I Review) \$355 - <b>Plus</b> Technical Review Fee of \$300 x number of locations Final Cost: Actual costs incurred by the City to review, including outside consulting costs. Applicants will be refunded any over payment and invoiced any under payment
<b>Staff interpretation (written)</b>	
Without public notice (including zone compliance letter)	\$271
With public notice	1,761
<b>Street Vacation</b>	
	\$4,222

Adopted by Resolution 2620.

Note: Each fee component stands alone and may require multiple components

Planning Division Fees Effective February 28, 2020

Fee Type	Fee
<b>Temporary Use and Sign Permits</b>	
Class I < 15 days	\$69
Class I 15 - 30 days	\$95
Class I Annual Event Signs	\$48
Class II 31-60 days	\$435
Class II 61-120 days (signs only)	\$583
Class II 61-120 days (other temporary uses, may incorporate concurrent sign request)	\$652
DRB Review more than 120 days (non-sign temporary uses only)	\$1,867
<b>Tentative Plat Review</b>	
Partition	
Administrative Review	\$1,072
DRB Review	\$2,249
Subdivision	
	Base fee \$3,236
	<b>Plus \$37/lot</b>
<b>Tree Permit</b>	
Type A Permit	
3 or fewer trees	\$21
Type B or C Permit	
3 or fewer trees	\$106
4 - 10 trees	\$149 + \$11/tree to be removed
11 - 25 trees	\$308 + \$11/tree to be removed
26 or more trees	\$329 + \$11/tree to be removed
Type D Permit	
	\$796
DRB Review of Type C Tree Removal Plan	
	\$164
<b>Urban Reserve Concept Plan – Initiated by Owners</b>	
0 to 50 acres	Base fee \$2,652 <b>Plus \$159/hour for Staff Review/Report/Research Time, Not to exceed \$12,731</b>
51 to 250 acres	Base fee \$5,304 <b>Plus \$159/hour for Staff Review/Report/Research Time, Not to exceed \$23,377</b>
251+ acres	Base fee \$7,957 <b>Plus \$159/hour for Staff Review/Report/Research Time</b>

Adopted by Resolution 2620.

Note: Each fee component stands alone and may require multiple components

Planning Division Fees Effective February 28, 2020

Fee Type	Fee
<b>Variance</b>	
Administrative	\$705
DRB Review	\$3,204
<b>Waiver</b>	
per waiver	\$583
<b>Villebois Expedited Review</b>	
	Double applicable fee
<b>Villebois FDP</b>	
	\$1,613
<b>Zone Change</b>	
Legislative text	\$10,073 + \$902 if BM 56 notice is required
Legislative Map	\$6,790 + \$902 if BM 56 notice is required
Quasi-judicial Map	\$3,305
<b>Zoning Verification Letter</b>	
	\$318

## Business Registry Business Name Search

[New Search](#)

## Business Entity Data

05-11-2020

11:37

Registry Nbr	<a href="#">Entity Type</a>	<a href="#">Entity Status</a>	<a href="#">Jurisdiction</a>	Registry Date	Next Renewal Date	Renewal Due?
1651895-99	FLLC	ACT	DELAWARE	03-04-2020	03-04-2021	
<b>Entity Name</b>	PWII OWNER, LLC					
<b>Foreign Name</b>						

[New Search](#)

## Associated Names

Type	PPB	PRINCIPAL PLACE OF BUSINESS		
<b>Addr 1</b>	222 SW COLUMBIA ST STE 700			
<b>Addr 2</b>				
<b>CSZ</b>	PORTLAND	OR	97201	<b>Country</b> UNITED STATES OF AMERICA

Please click [here](#) for general information about registered agents and service of process.

Type	AGT	REGISTERED AGENT	Start Date	03-04-2020	Resign Date	
<b>Of Record</b>	<a href="#">117651-95</a>	SKB HOLDING CORPORATION				
<b>Addr 1</b>	222 SW COLUMBIA ST STE 700					
<b>Addr 2</b>						
<b>CSZ</b>	PORTLAND	OR	97201	<b>Country</b>	UNITED STATES OF AMERICA	

Type	MAL	MAILING ADDRESS		
<b>Addr 1</b>	222 SW COLUMBIA ST STE 700			
<b>Addr 2</b>				
<b>CSZ</b>	PORTLAND	OR	97201	<b>Country</b> UNITED STATES OF AMERICA

[New Search](#)

## Name History

Business Entity Name	<a href="#">Name Type</a>	<a href="#">Name Status</a>	Start Date	End Date
PWII OWNER, LLC	EN	CUR	03-04-2020	

Please [read](#) before ordering [Copies](#).

[New Search](#)

## Summary History

Image Available	Action	Transaction Date	Effective Date	<a href="#">Status</a>	Name/Agent Change	Dissolved By
	APPLICATION FOR AUTHORITY	03-04-2020		FI	Agent	

© 2020 Oregon Secretary of State. All Rights Reserved.

## Business Registry Business Name Search

[New Search](#)

## Business Entity Data

05-11-2020  
11:50

Registry Nbr	Entity Type	Entity Status	Jurisdiction	Registry Date	Next Renewal Date	Renewal Due?
117651-95	DBC	ACT	OREGON	12-09-2002	12-09-2020	
<b>Entity Name</b>	SKB HOLDING CORPORATION					
<b>Foreign Name</b>						

[New Search](#)

## Associated Names

Type	PPB	PRINCIPAL PLACE OF BUSINESS		
<b>Addr 1</b>	222 SW COLUMBIA ST STE 700			
<b>Addr 2</b>				
<b>CSZ</b>	PORTLAND	OR	97201	<b>Country</b> UNITED STATES OF AMERICA

Please click [here](#) for general information about registered agents and service of process.

Type	AGT	REGISTERED AGENT	Start Date	11-01-2017	Resign Date	
<b>Name</b>	TODD	M	GOODING			
<b>Addr 1</b>	222 SW COLUMBIA ST STE 700					
<b>Addr 2</b>						
<b>CSZ</b>	PORTLAND	OR	97201	<b>Country</b>	UNITED STATES OF AMERICA	

Type	MAL	MAILING ADDRESS		
<b>Addr 1</b>	222 SW COLUMBIA ST STE 700			
<b>Addr 2</b>				
<b>CSZ</b>	PORTLAND	OR	97201	<b>Country</b> UNITED STATES OF AMERICA

Type	PRE	PRESIDENT		Resign Date	
<b>Name</b>	TODD	M	GOODING		
<b>Addr 1</b>	222 SW COLUMBIA ST STE 700				
<b>Addr 2</b>					
<b>CSZ</b>	PORTLAND	OR	97201	<b>Country</b>	UNITED STATES OF AMERICA

Type	SEC	SECRETARY		Resign Date	
<b>Name</b>	GEORGE		SCHRECK		
<b>Addr 1</b>	222 SW COLUMBIA STREET SUITE 700				
<b>Addr 2</b>					
<b>CSZ</b>				<b>Country</b>	

PORTLAND	OR	97201		UNITED STATES OF AMERICA
----------	----	-------	--	--------------------------

[New Search](#)









## Name History

Business Entity Name	Name Type	Name Status	Start Date	End Date
SKB HOLDING CORPORATION	EN	CUR	12-09-2002	

Please [read](#) before ordering [Copies](#).

[New Search](#)

## Summary History

Image Available	Action	Transaction Date	Effective Date	Status	Name/Agent Change	Dissolved By
	AMENDED ANNUAL REPORT	12-02-2019		FI		
	AMENDED ANNUAL REPORT	12-03-2018		FI		
	AMENDED ANNUAL REPORT	11-01-2017		FI	Agent	
	AMENDED ANNUAL REPORT	12-28-2016		FI		
	REINSTATEMENT AMENDED	02-26-2016		FI		
	ADMINISTRATIVE DISSOLUTION	02-04-2016		SYS		
	AMENDED ANNUAL REPORT	11-24-2014		FI		
	AMENDED ANNUAL REPORT	10-24-2013		FI		
	ANNUAL REPORT PAYMENT	11-23-2012		SYS		
	CHANGE OF REGISTERED AGENT/ADDRESS	07-12-2012		FI		
	AMNDMT TO ANNUAL RPT/INFO STATEMENT	07-12-2012		FI		
	ANNUAL REPORT PAYMENT	11-18-2011		SYS		
	ANNUAL REPORT PAYMENT	11-04-2010		SYS		
	ANNUAL REPORT PAYMENT	11-05-2009		SYS		
	ANNUAL REPORT PAYMENT	11-06-2008		SYS		
		12-07-2007		SYS		



	ANNUAL REPORT PAYMENT					
	ANNUAL REPORT	12-14-2006		FI		
	ANNUAL REPORT PAYMENT	12-02-2005		SYS		
	CHANGE OF REGISTERED AGENT/ADDRESS	09-27-2005		FI		
	AMNDMT TO ANNUAL RPT/INFO STATEMENT	07-12-2005		FI		
	ANNUAL REPORT	12-17-2004		FI		
	CHANGE OF REGISTERED AGENT/ADDRESS	11-25-2003		FI	Agent	
	AMENDED ANNUAL REPORT	11-25-2003		FI		
	ARTICLES OF INCORPORATION	12-09-2002		FI	Agent	

© 2020 Oregon Secretary of State. All Rights Reserved.

**APPROVED  
PLANNING DIVISION**

*Philip Bradford*

CITY OF WILSONVILLE

11/13/2020

City of Wilsonville

**Planning Department**

Application For:

**Parkway Woods Business Park  
Improvements – Planned Development -  
Stage II (Modification), Site Design Review,  
Tree Permit (Type C), SROZ Review  
(Verification) and Master Sign Plan**

Map & Tax Lots: T3S R1W Section 12, Tax Lots 511, 581 & 591

Prepared For:

**Owner/Applicant:**

**PWII Owner, LLC.**

222 SW Columbia Street, Suite 700

Portland, OR 97201

Contact: Todd Gooding, Registered Agent

Phone: (503) 220.2600

Matt Morvaj, VP Asset Management

[mmorvaj@skbcos.com](mailto:mmorvaj@skbcos.com)

Phone: (503) 783.6260

Prepared By:

**Applicant's Representatives:**

**Mildren Design Group, Inc.**

7650 SW Beveland Street, Suite 120

Tigard, Oregon 97223

Contact: Tuan Luu

Phone: (503) 244.0552

[tuan@mdgpc.com](mailto:tuan@mdgpc.com)

**Atwell, Inc.**

9755 SW Barnes Road, Suite 150

Portland, Oregon 97225

Contact: Brady Berry

Phone: (503) 334.8962

[bberry@atwell-group.com](mailto:bberry@atwell-group.com)

Original Submittal - May 2020

2nd Submittal - July 2020

3rd Submittal - August 2020

**DRB Submittal - October 16, 2020**

## **A.** ***Introduction***

---

- 1. Development Team Members**
- 2. Property and Zoning Summary**
- 3. Background Information**
- 4. Project Summary**
- 5. Key Issues**
- 6. Prior Land Use Approvals**
- 7. Land Use Reviews Requested**
- 8. Application Fee Calculation**



## 1. Development Team Members:

Listed below is a summary of the development team members for the **Parkway Woods Business Park Improvements** proposal.

<b>Owner:</b>	<b>SKB Holding Corporation</b> 222 SW Columbia Street, Suite 700 Portland, OR 97201 Telephone: (503) 220.2600 Contact: Todd Gooding, Registered Agent Email: <a href="mailto:tgooding@skbcos.com">tgooding@skbcos.com</a>
<b>Applicant:</b>	<b>PWII Owner, LLC</b> 222 SW Columbia Street, Suite 700 Portland, OR 97201 Telephone: (503) 783.6260 Contact: Matt Morvai Email: <a href="mailto:mmorvai@skbcos.com">mmorvai@skbcos.com</a>
<b>Legal:</b>	<b>Stoel Rives, LLP</b> 760 SW Ninth Avenue, Suite 3000 Portland, OR 97205 Telephone: (503) 294.9218 Contact: Dana Krawczuk Email: <a href="mailto:dana.krawczuk@stoel.com">dana.krawczuk@stoel.com</a>
<b>Architecture:</b>	<b>Mildren Design Group</b> 7650 SW Beveland Street, Suite 120 Tigard, OR 97223 Telephone: (503) 244.0552 Contact: Tuan Q. Luu Email: <a href="mailto:tuan@mdgpc.com">tuan@mdgpc.com</a>
<b>Civil Engineering:</b>	<b>ATWELL, LLC.</b> 9755 SW Barnes Road, Suite 150 Portland, OR 97225 Telephone: (971) 334.8962 Contact: Brady Berry, PE Email: <a href="mailto:brady.berry@atwell-group.com">brady.berry@atwell-group.com</a>
<b>Planning:</b>	<b>ATWELL, LLC.</b> 9755 SW Barnes Road, Suite 150 Portland, OR 97225 Telephone: (971) 334.8964 Contact: Kevin Apperson, RLA, ASLA Email: <a href="mailto:kevin.apperson@atwell-group.com">kevin.apperson@atwell-group.com</a>

**Geotechnical:**

**GeoEngineers Inc.**

333 High Street NE, Suite 102  
Salem, OR 97301  
Telephone: (971) 304.3078  
Contact: Julio Vela, PE  
Email: [jvela@geoengineers.com](mailto:jvela@geoengineers.com)

**Landscape Architecture:**

**ATWELL, LLC./RVI**

9755 SW Barnes Road, Suite 150  
Portland, OR 97225  
Telephone: (971) 334.8961  
Contact: Hal Keever, RLA, ASLA  
Email: [hal.keever@atwell-group.com](mailto:hal.keever@atwell-group.com)

**Environmental:**

**Pacific Habitat Services**

9450 SW Commerce Circle, Suite 180  
Wilsonville, OR 97070  
Telephone: (503) 570.0800  
Contact: John Van Staveren, PWS  
Email: [jvs@pacifichabitat.com](mailto:jvs@pacifichabitat.com)

**Arboriculture:**

**Teragan & Associates, Inc.**

3145 Westview Circle  
Lake Oswego, OR 97034  
Telephone: (503) 697-1975  
Contact: Todd Prager, Senior Associate  
Email: [todd@teragan.com](mailto:todd@teragan.com)

**Surveying: Topographical**

**Chase, Jones & Associates Inc.**

716 S.E. 11th Ave.  
Portland, OR 97214  
Telephone: (503) 228.9844  
Contact: Brady McGarry  
Email: [brady@chasejonesinc.com](mailto:brady@chasejonesinc.com)

**Signage:**

**FINE**

1140 SW 11th Avenue #200  
Portland, OR 97205  
Telephone: (503).869.6975  
Contact: Nikki Burian  
Email: [nikki@wearefine.com](mailto:nikki@wearefine.com)

**Site Lighting:**

**Harry L. Stearns, Inc.**

7305 NE Glisan Street  
Portland, OR 97213  
Telephone: (503).201.7690  
Contact: Robbie Kenagy  
Email: [rkenagy@hlstearns.com](mailto:rkenagy@hlstearns.com)

## 2. Property and Zoning Summary

Legal Description:	Map T3S R1W 12      Tax Lots 511, 581 & 591
Parcel Size:	88.28 Acres (includes roughly 34.59 acres of undeveloped land north of Printer Parkway.
Land Use:	Industrial (I)
Zoning:	Planned Development Industrial (PDI)

## 3. Background Information

Ownership: At one time the subject property was the headquarters of the Tektronix Corporation. Xerox acquired the subject property approximately 20 years ago when it purchased for Tektronix's color printing business.

In 2015, Xerox sold a portion of the original property to Portland real estate investment firm Scanlan Kemper Bard (SKB). SKB's initial plans were to convert the property into an office park. This marked the inception of the Parkway Woods Business Park development. Over the next several years, SKB implemented major improvements consisting of a lobby renovation, the addition of a tenant lounge and fitness area, upgrades to a majority of the building's systems, the addition of a 9-hole disc golf course, and significant landscaping and improvements to signage.

In 2020, ScanlanKemperBard (SKB) has announced a joint venture with RGA ReCap Incorporated (ReCap Real Estate Investments) on behalf of Reinsurance Group of America, Incorporated (RGA), to acquire Parkway Woods Business Park.

Leasing History: Over the last five plus years, the Applicant has had some success in leasing various portions of the building. At the present time, the building contains primary tenants: 1) 3D systems and 2) Dealer Spike. In addition, the Xerox Corporation leases a small portion of the building. However, due to changing market demands, this has proven to be increasing difficult given the current building configuration and access.

Market Demand: To address the changing demands, the Company intends on enhancing the existing improvements and tenant base through significant investment in capital improvements that are designed to cater to growing demand from light industrial, manufacturing, and R&D tenants.

## 4. Project Summary

The subject property currently consists of three tax lots that make up parcel 3 of Partition Plat No. 2018-109 containing 88.28 acres. The site is irregularly shaped and is generally bordered by SW Printer Parkway/SW Wiedemann Road (not constructed) on the north, SW Canyon Creek Road on the east, SW Xerox Drive on the south and SW Parkway Avenue on the west.

The property is zoned Planned Development Industrial (PDI).

The Owner/Applicant is proposing minor improvements to the existing building (i.e. installation of new entries, loading doors and windows) as well as functional/aesthetic improvements to the site consisting of a reconfiguration and expansion of the surface parking lot and construction of an outdoor plaza.

More specifically, each of the components is described below:

Building Improvements: The improvements are being proposed in order to facilitate industrial flex space (IFS). This is a type of use that can be used as office, warehouse or a combination of both. These types of uses are generally characterized as single story, industrial-type building that's generally 25-100 percent office space. Ceiling heights are 14 to 16 feet and the parking ratio is usually four to one, in case the building goes 100 percent office.

The proposed modifications to the building consist of five (5) new pedestrian entries into the development: 1) one new entry along the northwest corner of the building; 2) one new storefront entry along the southwest portion of the building and 2) three (3) new entries off plaza along the south side of the building. In addition to the new entries, new windows will be added to the west and south facades of the building, primarily located on the west end of the development. Finally, new loading doors/berths will be added to provide truck and freight service to each space.

Surface Parking Lot Reconfiguration and Improvements: While there will be no net increase in the amount of parking, the existing surface parking areas will be reconfigured to improve circulation for industrial flex space (IFS). The reconstructed parking areas will include new landscape islands and include preserved trees or new tree plantings and landscaping.

To enhance the new development areas, the site will be landscaped with native and ornamental plants and will encompass stormwater improvements in accordance with City of Wilsonville standards. Below is a summary of the proposed lot coverage (at ground level).

<b>Area</b>	<b>Lot Coverage (Expressed in Square Footage)</b>	<b>Percentage of Net Site</b>
<b>Gross Site Area:</b>	<b>88.28 Ac. (3,845,477 SF)</b>	
<i>Reserved for Future Dedication:</i>		
<i>ROW - SW Printer Parkway</i>	3.87 Ac. (168,704 SF)	
<b>Net Site Area:</b>	<b>84.41 Ac. (3,676,773 SF)</b>	
Existing Structure	8.89 Ac. (387,453 SF)	10.5%
Surface Parking/Drive Aisles/Loading Berths	23.54 Ac. (1,025,330,SF)	27.9%
Hardscape Area (sidewalks, plaza, walkways, etc.)	1.67 Ac. (72,514 SF)	2.0%
Landscaped Areas/Natural Areas	19.25 Ac. (838,502 SF)	22.8%
Open Space Enhancement Area:	31.06 Ac. (1,352,974 SF)	36.8%
<b>Total</b>		<b>100.0%</b>



The table of contents of this application outlines all the application criteria, exhibit drawings and appendices submitted for review and approval. Please refer to the application text and drawings for more detailed information regarding the proposed application.

## 5. Key Issues

### A. Tree Preservation:

The project requires the removal of trees for construction of the new parking, loading, and entry areas throughout the site. In addition, trees that are in poor or very poor condition are proposed for removal for safety purposes, and to improve the space, light, and growing conditions of the trees to be retained. Also, nuisance species which are non-native trees with the capacity to self-propagate and outcompete native species including English hawthorn (*Crataegus monogyna*) European birch (*Betula pendula*), Norway maple (*Acer platanoides*), and sweet cherry (*Prunus avium*), are proposed for removal.

Through the design process, the Owner/Applicant explored a number of different alternative proposals for the placement of circulation routes and expanded surface parking areas. With each design iteration, a greater number of trees were able to be preserved. Through this evolution process over 100 additional trees were added to the saved and incorporated into the design. Special attention was given to preserving as many of the Oregon White Oaks and Ponderosa Pines as possible. Based on the proposed site plan, 312 trees are proposed for removal. It is important to note that only 163 of these are in healthy condition. An additional 146 trees that are nuisance species, in poor or very poor health condition, or less than 6-inch DBH are proposed for removal. The remaining 296 assessed trees at the site will be retained.

Mitigation is recommended for the removal at a ratio of 1:1. The Owner/Applicant anticipates satisfying the tree mitigation requirements through a combination of new parking lot trees throughout the property, infill planting of native trees (i.e. Ponderosa Pines and Oregon White Oaks) in selected areas through the property, buffer enhancement plantings along the seasonal drainage located along the east side of the property and the planting of site ornamental trees along the building façade and plaza areas. The proposed landscape plan indicates the locations of 2-inch caliper mitigation trees in accordance with Section 4.620.00 of the City of Wilsonville Code.

Protection recommendations for the 296 trees to be retained at the site are provided in the Arborist Report contained in Section D of this application.

### B. Verification of SROZ Boundary:

Based on the City's mapping, the subject property contains several areas that have been included in City's Significant Resource Overlay Zone (OZ). The first area located along SW Xerox Drive and parallels the roadway along the south side of the existing building. A finger of this boundary extends northward towards the building and generally follows a small depression swale north and south of SW Xerox Drive. A second area extends along the southeastern boundary of the property and continues northward and encompasses nearly all of the undeveloped land in the northeast portion of the property.

Because SROZ is a generalized boundary based on GIS information, the Owner/Applicant completed a delineation of the actual SROZ area to further refine the boundary and define where impacts might occur.

For the most part, the area within the SROZ boundary will be unaffected by the proposed development. However, a small man-made drainage area (approximately 408 square feet) north of SW Xerox Drive is proposed to be filled in order to accommodate a new loading dock and shipping/receiving area. The Corp of Engineers has determined that the man-made drainage swale is not waters of the U.S. Similarly, the Oregon Department of State Lands will not be involved in the filling of the man-made drainage swale because the wetland requires less than 50 cubic yards of fill.

To mitigate for filling of the man-made drainage swale, the Owner/Applicant will be enhancing the buffer adjacent to the seasonal drainage area along the eastern boundary of the property.

C. Public Improvements:

SW Parkway Avenue is a partially improved public street that is owned and maintained by the City of Wilsonville. It has been designated as a Minor Arterial and currently contains two travel lanes with no bike lanes, curbs, or sidewalks. SW Printer Parkway is a private street owned by Parkway Woods Business Park. It has been designed as a Collector and currently contains two travel lanes with not bike lanes or sidewalks.

The City has identified SW Printer Parkway as a public Collector in their Transportation System Plan. As such, the City has requested that the Owner/Applicant protect and not include improvements within the ultimate right-of-way along SW Printer Parkway in order to accommodate a public street meeting Collector Street standard in the future.

Since the proposed improvements are limited to minor building improvements and site work, there is no nexus for requiring public improvements to SW Parkway Avenue or SW Printer Parkway at this time.

**6. Prior Land Use Approvals**

Below is a list of prior land use approvals affecting the subject property.

Land Use File	Type	Jurisdiction
2000-089	Partition Plat	City of Wilsonville
2002-047	Partition Plat	City of Wilsonville
2005-022	Partition Plat	City of Wilsonville
	Stage I Planned Development (Preliminary)	City of Wilsonville
	State II Planned Development (Final)	City of Wilsonville
2015-083	Partition Plat	City of Wilsonville
2018-109	Partition Plat	City of Wilsonville

## 7. Land Use Reviews Requested

The City of Wilsonville Development Code Standards identify various procedural reviews based upon the type of land use action being requested. For this application, the Owner/Applicant is requesting the following concurrent reviews.

Land Use Request	Type
Planned Development - Stage II (Modification)	III
Site Design Review	II
Tree Removal (Type C)	III
SROZ Review (Verification)	I
Master Sign Plan	III

## 8. Fee Calculations:

The proposed project is required to follow City standard and procedures. Based on City of Wilsonville Fee Schedule (effective February 20, 2020), the applicable fees associated with this application are:

Land Use Fees	Fee
Planned Development - Stage II (Modification)	\$2,992.00
Site Design Review <sup>(1)</sup>	\$10,284.00
Tree Removal (Type C) <sup>(2)</sup>	\$3,651.00
SROZ Review (Verification)	\$515.00
Master Sign Plan	\$1,422.00
<b>Total</b>	<b>18,864.00</b>

(1) Base fee \$2,249; Plus \$1,607 per occupied building subject to review; Plus \$1,607 per 5 acres, or portion thereof, of net site area [Assumes 19.35 acres are affected]

(2) \$329 + \$11/tree to be removed. Assumes 302 trees

## Planned Development Standards and Regulations for all Planned Development (PD) Zones

### Planned Development Standards and Regulations for all Planned Development (PD) Zones

#### Section Contains:

- **Section 4.118**                      **Standards applying to all Planned Development Zones**

#### **Section 4.118**                      **Standards applying to all Planned Development Zones:**

- (.01) Height Guidelines: In “S” overlay zones, the solar access provisions of Section 4.137 shall be used to determine maximum building heights. In cases that are subject to review by the Development Review Board, the Board may further regulate heights as follows:
- A. Restrict or regulate the height or building design consistent with adequate provision of fire protection and fire-fighting apparatus height limitations.
  - B. To provide buffering of low density developments by requiring the placement of three or more story buildings away from the property lines abutting a low density zone.
  - C. To regulate building height or design to protect scenic vistas of Mt. Hood or the Willamette River.

**Applicant’s Response:** *The subject property is located in the Planned Development Industrial (PDI) zoning district. Since no buildings are being proposed, these guidelines only have limited application to the proposed improvements.*

- A. Fire Protection: The proposed development does not include any new structures, so there are no restrictions or regulations related to building height and/or design. It should be noted that, with the proposed circulation and parking lot modifications, fire access to the perimeter building façades will be improved significantly. As part of the improvements, new parking areas and circulation aisles are being proposed along the southeast and east side of the building. Once the access and parking modifications are completed, there will be fire apparatus access to all points along the perimeter of the building.***
- B. Buffering of Low Density Developments: As mentioned above, the proposed development does not include any new buildings or height changes to existing buildings. The existing facades range in height from 20’-6” to 32’-6”. Furthermore, the building is already located in the central portion of the property and provides for generous setbacks from the adjoining property lines.***
- C. Protection of Scenic Vistas: Again, the proposed development does not include the construction of any new buildings. Therefore,***

***the current views or vistas will unaffected by the proposed improvements.***

- (.02) Underground Utilities shall be governed by Sections 4.300 to 4.320. All utilities above ground shall be located so as to minimize adverse impacts on the site and neighboring properties.

***Applicant's Response: As part of prior development approvals, all utilities have been placed underground. Since no new buildings are being proposed, no additional utilities will be necessary to serve the existing development.***

***With the exception of the installation of stormwater conveyance systems, the proposed circulation and parking lot modifications will not affect any of the underground utilities. There will be no adverse impacts on the site or to neighboring properties.***

***Refer to Section C – Exhibit Drawings, Exhibit 06 – Utility Plan – Overall (Preliminary) for additional information.***

- (.03) Notwithstanding the provisions of Section 4.140 to the contrary, the Development Review Board, in order to implement the purposes and objectives of Section 4.140, and based on findings of fact supported by the record may:

A. Waive the following typical development standards:

1. minimum lot area;
2. lot width and frontage;
3. height and yard requirements;
4. lot coverage;
5. lot depth;
6. street widths;
7. sidewalk requirements;
8. height of buildings other than signs;
9. parking space configuration and drive aisle design;
10. minimum number of parking or loading spaces;
11. shade tree islands in parking lots, provided that alternative shading is provided;
12. fence height;

13. architectural design standards;
14. transit facilities; and
15. On-site pedestrian access and circulation standards; and
16. Solar access standards, as provided in section 4.137.

*[Amended by Ord. #719, 6/17/13.]*

**Applicant's Response:** *In accordance with this section of the code, the Owner/Applicant understands that the Development Review Board may waive (if necessary) certain development standards if they are supported by findings of fact.*

*The project will meet the applicable development standards including: sidewalk requirements; parking space configuration and drive aisle design, minimum number of parking or loading spaces; tree shade islands and on-site pedestrian access and circulation standards.*

*Since the project is meeting the required development standards, a waiver is not required.*

- B. The following shall not be waived by the Board, unless there is substantial evidence in the whole record to support a finding that the intent and purpose of the standards will be met in alternative ways:
1. open space requirements in residential areas;
  2. minimum density standards of residential zones;
  3. minimum landscape, buffering, and screening standards;

**Applicant's Response:** *The proposed development meets the minimum standards for landscaping. The existing development is required to maintain 15% landscaping. Given the presence of the natural areas and landscaped zones throughout the property, the proposed development easily exceed this minimum landscape requirement.*

*Without taking into the consideration the open space enhancement area in the northeast portion of the property (north of SW Printer Parkway), the percentage of landscaping/native plantings is 838,502 square feet (19.25 Ac.) or 22.8% of the net site area. This figure exceeds the minimum requirement of 15%.*

*Refer to Section C – Exhibit Drawings, Exhibit 16 – Landscape Plan – Overall (Preliminary) for additional information. More detailed*

*landscape planting plans are provided in Section C – Exhibit Drawings, Exhibit Sheets 17 – 20.*

- C. The following shall not be waived by the Board, unless there is substantial evidence in the whole record to support a finding that the intent and purpose of the standards will be met in alternative ways, and the action taken will not violate any applicable federal, state, or regional standards:
1. maximum number of parking spaces;
  2. **standards for mitigation of trees that are removed;**
  3. **standards for mitigation of wetlands that are filled or damaged; and**
  4. trails or pathways shown in the Parks and Recreation Master Plan.

**Applicant's Response:** *The proposed development complies the parking, tree mitigation and wetland mitigation standards cited above.*

*The current building contains 387,453 gross square feet. Assuming a parking ratio 2.7 spaces per 1000 sq. ft. which is the required ratio for all anticipated use types within the project, the minimum number of required spaces (i.e. industrial flex space) would be 1,046 spaces. Conversely, the maximum allowed would be 4.1 spaces per 1,000 square feet. Based on this ratio, 1,589 stalls are allowed. It should be noted that the minimum and maximum requirements will vary slightly if the net square footage of each of the leasable area is are calculated individually. Currently, there are 1,221 existing stalls.*

*Based on the reconfiguration of the surface parking lot, there will be no net change in the number of stalls. The proposed plan identifies 1,221 stalls (excluding the NE Area). This includes 1,189 standard-sized stalls, seven (7) compact stalls and twenty five (25) accessible stalls. It is important to note that this area in the northeast corner of the existing development has been identified for a possible future building pad and the surface parking in this area will be eliminated in the future. For purposes of demonstrating compliance with the City's parking code, the proposed site plan illustrates 1,221 total stalls which is well below the maximum allowed by code.*

*As part of the improvements, the Owner/Applicant is requesting the removal of a total of 312 trees. Of this amount, 302 of the trees are required to be replanted at a 1:1 ratio as mitigation. The remaining 10 trees do not require mitigation since they are less than 6-inch BDH. It should be noted that only 163 trees of this total are considered healthy, non-nuisance trees. The Owner/Applicant anticipates satisfying the tree mitigation requirements through a combination of new parking lot trees throughout the property, infill planting of native*

**trees (i.e. Ponderosa Pines and Oregon White Oaks) in selected areas through the property, buffer enhancement plantings along the seasonal drainage located along the east side of the property and the planting of site ornamental trees along the building façade and plaza areas.**

**As part of the circulation and surface parking reconfiguration, one (1) small wetland area (consisting of approximately 412 square feet) is proposed to be filled to accommodate a new loading area on the south side of the building. The Corp of Engineers has determined that the man-made drainage swale is not waters of the U.S. Similarly, the Oregon Department of State Lands will not be involved in the filling of the man-made drainage swale because the wetland requires less than 50 cubic yards of fill. Therefore, the City is the only agency that maintains jurisdiction over the man-made drainage swale.**

**To mitigate for filling of the man-made drainage swale, the Owner/Applicant will be enhancing the buffer adjacent to the seasonal drainage area along the eastern boundary of the property.**

- D. Locate individual building, accessory buildings, off-street parking and loading facilities, open space and landscaping and screening without reference to lot lines; and

**Applicant's Response: The proposed site work occurs within a single lot. The Owner/Applicant has reconfigured the circulation and parking area to better serve the anticipated tenants and patrons while preserving the greatest number of the existing significant trees.**

- E. Adopt other requirements or restrictions, inclusive of, but not limited to, the following:
1. Percent coverage of land by buildings and structures in relationship to property boundaries to provide stepped increases in densities away from low-density development.
  2. Parking ratios and areas expressed in relation to use of various portions of the property and/or building floor area.
  3. The locations, width and improvement of vehicular and pedestrian access to various portions of the property, including portions within abutting street or private drive.  
*[amended by Ord. 682, 9/9/10]*
  4. Arrangement and spacing of buildings and structures to provide appropriate open spaces around buildings.
  5. Location and size of off-street loading areas and docks.
  6. Uses of buildings and structures by general classification, and by specific designation when there are unusual requirements for parking, or when the use involves noise,



dust, odor, fumes, smoke, vibration, glare or radiation incompatible with present or potential development of surrounding property. Such incompatible uses may be excluded in the amendment approving the zone change or the approval of requested permits.

7. Measures designed to minimize or eliminate noise, dust, odor, fumes, smoke, vibration, glare, or radiation which would have an adverse effect on the present or potential development on surrounding properties.
8. Schedule of time for construction of the proposed buildings and structures and any stage of development thereof to insure consistency with the City's adopted Capital Improvements Plan and other applicable regulations.
9. A waiver of the right of remonstrance by the applicant to the formation of a Local Improvement District (LID) for streets, utilities and/or other public purposes.
10. Modify the proposed development in order to prevent congestion of streets and/or to facilitate transportation.
11. Condition the issuance of an occupancy permit upon the installation of landscaping or upon a reasonable scheduling for completion of the installation of landscaping. In the latter event, a posting of a bond or other security in an amount equal to one hundred ten percent (110%) of the cost of the landscaping and installation may be required.
12. A dedication of property for streets, pathways, and bicycle paths in accordance with adopted Facilities Master Plans or such other streets necessary to provide proper development of adjacent properties.

**Applicant's Response: *The Owner/Applicant acknowledges that the Development Review Board has the authority to adopt other requirements or restrictions that are necessary to implement the purposes and objectives of the Planned Development Regulations.***

***Since the Owner/Applicant is meeting or exceeding the minimum standards, no additional measures are anticipated.***

- (.04) The Planning Director and Development Review Board shall, in making their determination of compliance in attaching conditions, consider the effects of this action on availability and cost. The provisions of this section shall not be used in such a manner that additional conditions, either singularly or cumulatively, have the effect of unnecessarily increasing the cost of development. However, consideration of these factors shall not prevent the Board from imposing conditions of approval necessary to meet the minimum requirements of the Comprehensive Plan and Code.

**Applicant's Response: *The Owner/Applicant understands that Planning Director and Development Review Board may, at their discretion, may consider the effects of any conditions of approval related to availability and cost.***

***However, these considerations will not preclude the Board from requiring such conditions of approval, as necessary, to meet the minimum requirements.***

- (.05) The Planning Director, Development Review Board, or on appeal, the City Council, may as a condition of approval for any development for which an application is submitted, require that portions of the tract or tracts under consideration be set aside, improved, conveyed or dedicated for the following uses:
- A. Recreational Facilities: The Director, Board, or Council, as the case may be, may require that suitable area for parks or playgrounds be set aside, improved or permanently reserved for the owners, residents, employees or patrons of the development consistent with adopted Park standards and Parks and Recreation Master Plan.

***Applicant's Response: The City's Parks and Recreation Master Plan does not identify any recreation facilities within the boundaries of this property. However, the Owner/Applicant and the City of Wilsonville have had previous discussion regarding a potential open space donation. Both parties mutually agreed that this property would be a valuable addition to the City's Park System. This agreement culminated in the passage of a City Council resolution memorializing the City willingness to accept roughly 31 acres in the northeast portion of the property. The Owner/Applicant is currently evaluating the timing, benefits and potential improvements associated with this possible future donation.***

***In addition, the Owner/Applicant is currently proposing to expand and enhance a dedicated area within the subject property for the purpose of providing recreational facilities to its various tenant and their employees as well as patrons to the development. Specifically, this would include the redevelopment of the outdoor plaza located along the south side of the existing structure. This will provide a variety of active and passive uses, such as basketball court, seating areas, picnic facilities, etc.***

***Refer to Section C – Exhibit Drawings, Exhibit 22 – Detailed Landscape Plans (Preliminary) and Exhibit 24 – Plaza Hardscape Plan (Preliminary) for additional information.***

- B. Open Space Area: Whenever private and/or common open space area is provided, the City shall require that an association of owners or tenants be established which shall adopt such Articles of Incorporation, By-Laws or other appropriate agreement, and shall adopt and impose such Declaration of Covenants and Restrictions on such open space areas and/or common areas that are acceptable to the Development Review Board. Said association shall be formed and continued for the purpose of maintaining such open space area. Such an association, if required, may undertake other functions. It shall be created in such a manner that owners of property shall automatically be members and shall be subject to assessments levied to maintain said open space area for the purposes intended. The period of existence of such association shall be not less

than twenty (20) years and it shall continue thereafter and until a majority vote of the members shall terminate it, and the City Council formally votes to accept such termination.

**Applicant's Response:** *There are no additional private open space is being proposed as part of the site improvements. However there are a number of areas that are undevelopable due to the presences of significant natural resources. These are currently being managed and maintained by the Owner.*

*Again, the Owner/Applicant is evaluating the possibility of a future open space donation to the City as a future natural resource area in the northeast portion of the property (north of Printer Parkway). This parcel contains a mixture of upland and forested wetland areas and abuts the powerline corridor.*

- C. Easements: Easements necessary to the orderly extension of public utilities, and the protection of open space, may be required as a condition of approval. When required, such easements must meet the requirements of the City Attorney prior to recordation.

**Applicant's Response:** *Currently, there is a 10 wide public utility easement along SW Parkway Avenue and SW Printer Parkway. In addition, there is a 20 foot wide private communication line easement that extends from SW Printer Parkway to the proposed development.*

*Based on the current site plan, no new utility easements have been proposed.*

*Refer to Section C – Exhibit Drawings, Exhibit 06 – Utility Plan - Overall (Preliminary) for additional information.*

- (.06) Nothing in this Code shall prevent the owner of a site that is less than two (2) acres in size from filing an application to rezone and develop the site as a Planned Development. Smaller properties may or may not be suitable for such development, depending upon their particular sizes, shapes, locations, and the nature of the proposed development, but Planned Developments shall be encouraged at any appropriate location.

**Applicant's Response:** *The subject property contains 88.28 acres and is currently zoned Planned Development Industrial (PDI).*

- (.07) Density Transfers. In order to protect significant open space or resource areas, the Development Review Board may authorize the transfer of development densities from one portion of a proposed development to another. Such transfers may go to adjoining properties, provided that those properties are considered to be part of the total development under consideration as a unit.

**Applicant's Response:** *While no density transfers are being requested as part of the Parkway Woods Business Park improvement work, the Owner/Applicant would*

**like to reserve the opportunity to transfer the allowable floor area (FAR) if the property to the northeast (north of Printer Parkway) is dedicated to the City as a public open space area.**

- (.08) Wetland Mitigation and other mitigation for lost or damaged resources. The Development Review Board may, after considering the testimony of experts in the field, allow for the replacement of resource areas with newly created or enhanced resource areas. The Board may specify the ratio of lost to created and/or enhanced areas after making findings based on information in the record. As much as possible, mitigation areas shall replicate the beneficial values of the lost or damaged resource areas.

**Applicant's Response: The project will involve filling a small man-made drainage swale [approximately 412 square foot in size] that is located between the existing building and SW Xerox Drive. The filling of this area is necessary to accommodate the construction of a new loading area/berth for shipping and receiving that will serve the tenants along the southwestern corner of the building. Currently, there are no loading areas along this side of the building.**

**The filling of the resource area would occur in accordance with the City of Wilsonville and appropriately mitigated. To mitigate for filling of the man-made drainage swale, the Owner/Applicant is proposing to enhance the vegetative buffer adjacent to the seasonal drainage corridor situated along the eastern boundary of the property. This would consist invasive removal and enhancement of approximately 20,013 square feet to include the planting of 25 trees and reseeding of the buffer with a native seed mix.**

**Refer to Section C – Exhibit Drawings, Sheet 21 – Buffer Enhancement Plan (Preliminary) for additional information.**

- (.09) Habitat-Friendly Development Practices. To the extent practicable, development and construction activities of any lot shall consider the use of habitat-friendly development practices, which include:
- A. Minimizing grading, removal of native vegetation, disturbance and removal of native soils, and impervious area;
  - B. Minimizing adverse hydrological impacts on water resources, such as using the practices described in Part (a) of Table NR-2 in Section 4.139.03, unless their use is prohibited by an applicable and required state or federal permit, such as a permit required under the federal Clean Water Act, 33 U.S.C. §§1251 et seq., or the federal Safe Drinking Water Act, 42 U.S.C. §§300f et seq., and including conditions or plans required by such permit;
  - C. Minimizing impacts on wildlife corridors and fish passage, such as by using the practices described in Part (b) of Table NR-2 in Section 4.139.03; and

D. Using the practices described in Part (c) of Table NR-2 in Section 4.139.03.

*[Section 4.118(.09) added by Ord. # 674 11/16/09]*

***Applicant's Response: To the extent practicable, the Owner/Applicant will implement habitat-friendly development practices with regards to development and construction activities within the subject property. At a minimum, this will include minimizing the amount of grading, minimizing removal of native vegetation and disturbance and minimizing removal of native soils to the extent possible yet still meet the projects objectives.***

***Although some new impervious surfacing is proposed, a majority of the site work involves the reconfiguration and replacement of pavement in areas that currently contain impervious surfaces (i.e. existing parking lots). As part of the parking reconfiguration, LIDA measures will be incorporated in to the design in order to minimize adverse impacts on water resources. Rain gardens are dispersed throughout the parking areas which treat the runoff prior to entering the conveyance systems.***

***It is also important to note, that the Owner/Applicant is also exploring the possibility of a significant land donation to the City as natural area, thus ensuring that a large portion of the overall property will remain undeveloped in perpetuity.***

***Refer to Section C – Exhibit Drawings, Exhibit 05 – Grading and Drainage Plan - Overall (Preliminary) for additional information.***

## Planned Development Regulations

### Section Contains:

- Section 4.140 Planned Development Regulations

### Section 4.140. Planned Development Regulations.

#### (.01) Purpose.

- A. The provisions of Section 4.140 shall be known as the Planned Development Regulations. **The purposes of these regulations are to encourage the development of tracts of land sufficiently large to allow for comprehensive master planning, and to provide flexibility in the application of certain regulations in a manner consistent with the intent of the Comprehensive Plan and general provisions of the zoning regulations and to encourage a harmonious variety of uses through mixed use design within specific developments thereby promoting the economy of shared public services and facilities and a variety of complimentary activities consistent with the land use designation on the Comprehensive Plan and the creation of an attractive, healthful, efficient and stable environment for living, shopping or working.**

***Applicant's Response: The proposal is consistent with the purpose of the Planned Development Regulations as demonstrated below.***

- B. It is the further purpose of the following Section:
1. To take advantage of advances in technology, architectural design, and functional land use design:
  2. To recognize the problems of population density, distribution and circulation and to allow a deviation from rigid established patterns of land uses, but controlled by defined policies and objectives detailed in the comprehensive plan;
  3. To produce a comprehensive development equal to or better than that resulting from traditional lot land use development.
  - 4. To permit flexibility of design in the placement and uses of buildings and open spaces, circulation facilities and off-street parking areas, and to more efficiently utilize potentials of sites characterized by special features of geography, topography, size or shape or characterized by problems of flood hazard, severe soil limitations, or other hazards;**
  5. To permit flexibility in the height of buildings while maintaining a ratio of site area to dwelling units that is consistent with the densities established by the Comprehensive Plan and the intent of the Plan to provide open space, outdoor living area and buffering of low-density development.

6. To allow development only where necessary and adequate services and facilities are available or provisions have been made to provide these services and facilities.
7. To permit mixed uses where it can clearly be demonstrated to be of benefit to the users and can be shown to be consistent with the intent of the Comprehensive Plan.
8. To allow flexibility and innovation in adapting to changes in the economic and technological climate.

**Applicant's Response:** *For the Parkway Woods Business Park, it is important to note that the code allows for the flexibility in the design and placement of uses, circulation facilities and off-street parking areas in order to more efficiently utilize sites characterized by features of geography, topography, size or shape (such as lowlands/wetland and drainage features).*

*With regards to the proposed development, the proposal requires modification of the SNOZ resource boundary to allow changes in the site layout (i.e. changes to parking, loading and circulation) to facilitate functional changes to the interior of the building.*

(.02) Lot Qualification.

- A. Planned Development may be established on lots which are suitable for and of a size to be planned and developed in a manner consistent with the purposes and objectives of Section 4.140.

**Applicant's Response:** *The subject property is currently zoned Planned Development Industrial (PDI). No land divisions are proposed at this time. The future right-of-way location along SW Printer Parkway has been shown on the plans to illustrate limits of future City street improvements and will not adversely impact the potential future land divisions.*

- B. Any site designated for development in the Comprehensive Plan may be developed as a Planned Development, provided that it is zoned "PD." All sites which are greater than two (2) acres in size, and designated in the Comprehensive Plan for commercial, residential, or industrial use shall be developed as Planned Developments, unless approved for other uses permitted by the Development Code. Smaller sites may also be developed through the City's PD procedures, provided that the location, size, lot configuration, topography, open space and natural vegetation of the site warrant such development.

**Applicant's Response:** *The subject property is zoned PDI and no zone changes are proposed.*

(.03) Ownership.

- A. The tract or tracts of land included in a proposed Planned Development must be in one (1) ownership or control or the subject of a joint application by the owners of all the property included. The holder of a written option to purchase, with written authorization by the owner to make applications, shall be deemed the owner of such land for the purposes of Section 4.140.

**Applicant's Response:** *In accordance with this section, the subject property, consisting of three (3) tax lots) is under one ownership, PWII Owner, LLC. Scanlan Kemper Bard (SKB), LLC is the holding company for PWII Owner, LLC.*

*Refer to Section D – Appendices, Appendix 2 – TRIO for information on the three (3) parcels included in this application.*

- B. Unless otherwise provided as a condition for approval of a Planned Development permit, the permittee may divide and transfer units or parcels of any development. The transferee shall use and maintain each such unit or parcel in strict conformance with the approval permit and development plan.

**Applicant's Response:** *Unit and parcel transfers are not proposed as part of this application.*

(.04) Professional Design.

- A. The applicant for all proposed Planned Developments shall certify that the professional services of the appropriate professionals have been utilized in the planning process for development.

**Applicant's Response:** *The Owner/Applicant retained a number of professional service firms to provide technical work associated with the improvements to the Parkway Woods Business Park. This included land surveying, geotechnical, arboriculture, biological, planning, engineering, architectural, lighting, landscape architectural and signage design professionals.*

*Refer to Section A – Introduction for a list of team members that provided technical and professional services in conjunction with the proposed improvements.*

- B. Appropriate professionals shall include, but not be limited to the following to provide the elements of the planning process set out in Section 4.139:
1. An architect licensed by the State of Oregon;
  2. A landscape architect registered by the State of Oregon;



3. An urban planner holding full membership in the American Institute of Certified Planners, or a professional planner with prior experience representing clients before the Development Review Board, Planning Commission, or City Council; or
4. A registered engineer or a land surveyor licensed by the State of Oregon.

**Applicant's Response:** *In accordance with this section, the Owner/Applicant has retained the following firms to provide technical information in the planning process.*

- 1) *Architecture: Mildren Design Group*
- 2) *Landscape Architecture: RVI*
- 3) *Planning & Civil Engineering: Atwell, LLC*
- 4) *Surveying: Chase Jones*

*In addition, Teragan and Associates provided arboriculture services related to the preservation of trees, Pacific Habitats provided wetland and natural resource services associated with the SROZ boundary delineation; FINE provided signage consultation and design; and Harry L. Stearn provided site lighting design.*

- C. One of the professional consultants chosen by the applicant from either 1, 2, or 3, above, shall be designated to be responsible for conferring with the planning staff with respect to the concept and details of the plan.

**Applicant's Response:** *For purposes of this section, Atwell, LLC has been the primary contact with planning staff.*

- D. The selection of the professional coordinator of the design team will not limit the owner or the developer in consulting with the planning staff.

**Applicant's Response:** *The Owner/Applicant has also been involved in consultation with staff about the project.*

(.05) Planned Development Permit Process.

- A. All parcels of land exceeding two (2) acres in size that are to be used for residential, commercial or industrial development, shall, prior to the issuance of any building permit:
  1. Be zoned for planned development;
  2. Obtain a planned development permit; and
  3. Obtain Development Review Board, or, on appeal, City Council approval.

**Applicant's Response:** *This application seeks a Stage II Planned Development (Modification) and Site Design Review in order to enable the Owner/Applicant to*

***expand and enhance the surface parking area/circulation/loading and construct the new plaza area on the south side of the building.***

- B. Zone change and amendment to the zoning map are governed by the applicable provisions of the Zoning Sections, inclusive of Section 4.197

***Applicant's Response: No zone changes are proposed. The intended uses are permitted outright within the Planned Development Industrial zoning district.***

- C. Development Review Board approval is governed by Sections 4.400 to 4.450

***Applicant's Response: This application seeks a Stage II Planned Development modification, Site Design Review, authorization to remove trees, and approval of a Sign Master Plan. These reviews require approval of the Development Review Board.***

- D. All planned developments require a planned development permit. The planned development permit review and approval process consists of the following multiple stages, the last two or three of which can be combined at the request of the applicant:

1. Pre-application conference with Planning Department;
2. Preliminary (Stage I) review by the Development Review Board. When a zone change is necessary, application for such change shall be made simultaneously with an application for preliminary approval to the Board; and
- 3. Final (Stage II) review by the Development Review Board**
4. In the case of a zone change and zone boundary amendment, City Council approval is required to authorize a Stage I preliminary plan.

***Applicant's Response: A pre-application meeting was requested and subsequently held on February 20, 2020.***

***It should be noted that the current Stage I (Preliminary) Planned Development permit and the Stage II (Final) Planned Development Permit were applied for and approved long ago. More recently, the Owner/Applicant applied for and received approval for a Minor Partition in 2018. Refer to Section D – Appendices, Appendix 8 – Staff Report/Notice of Decision for Prior Land Use Approvals (case file 2018-109).***

***In order to modify the previously approved Stage II Planned Development, a new Final (Stage II) review is required. Based on this, in order to gain approval for the Owner/Applicants desired improvements (i.e. minor modifications to the exterior of the buildings and reconfiguration of the surface parking lot/circulation/loading and***

**landscaped areas), a new review is required by the Development Review Board.**

(.06) Staff Report:

- A. The planning staff shall prepare a report of its findings and conclusions as to whether the use contemplated is consistent with the land use designated on the Comprehensive Plan. If there is a disagreement as to whether the use contemplated is consistent, the applicant, by request, or the staff, may take the preliminary information provided to the Development Review Board for a use interpretation.

***Applicant's Response:*** *In accordance with this section, the Owner/Applicant understands that the planning staff will prepare a report of its findings and conclusions as to whether the use(s) currently being contemplated are consistent with the applicable City's codes and regulations.*

- B. The applicant may proceed to apply for Stage I - Preliminary Approval - upon determination by either staff or the Development Review Board that the use contemplated is consistent with the Comprehensive Plan.

***Applicant's Response:*** *A Stage I (Preliminary) Planned Development Permit has already been improved for the site. This criterion does not apply.*

(.07) Preliminary Approval (Stage One): ***This criterion is not applicable to this application since it already received preliminary and final approval. The request is a modification of the final plan approval.***

(.09) Final Approval (Stage Two):

- A. Unless an extension has been granted by the Development Review Board, within two (2) years after the approval or modified approval of a preliminary development plan (Stage I), the applicant shall file with the City Planning Department a final plan for the entire development or when submission in stages has been authorized pursuant to Section 4.035 for the first unit of the development, a public hearing shall be held on each such application as provided in Section 4.013.

***Applicant's Response:*** *The site has an approved preliminary and final plan. However, in order to modify the previously approved Stage II (Final) Planned Development permit, a new Stage II review is required to allow the desired improvements (i.e. exterior improvements and modification and expansion of the surface parking/circulation).*

- B. After such hearing, the Development Review Board shall determine whether the proposal conforms to the permit criteria set forth in this Code, and shall approve, conditionally approve, or disapprove the application.

**Applicant's Response:** *The Owner/Applicant acknowledge that after the hearing, the Development Review Board will approve, conditionally approve, or disapprove the application based on the evidence provided.*

- C. The final plan shall conform in all major respects with the approved preliminary development plan, and shall include all information included in the preliminary plan plus the following:
1. The location of water, sewerage and drainage facilities;
  2. Preliminary building and landscaping plans and elevations, sufficient to indicate the general character of the development;
  3. The general type and location of signs;
  4. Topographic information as set forth in Section 4.035;
  5. A map indicating the types and locations of all proposed uses; and
  6. A grading plan.

**Applicant's Response:** *Since the proposed design program is similar in nature to what currently exists, it is assumed that the proposal complies with all elements of the original approved Stage I Preliminary Plan. The required elements for the revised Stage II final plan are included in this Section C – Exhibit Drawings and Section D - Appendices.*

*Refer to Section C – Exhibit Drawings, for additional information on the proposed development plans as well as Section D – Appendices, Appendix 30 – Master Sign Plan for information on the sign locations.*

- D. The final plan shall be sufficiently detailed to indicate fully the ultimate operation and appearance of the development or phase of development. However, Site Design Review is a separate and more detailed review of proposed design features, subject to the standards of Section 4.400.

**Applicant's Response:** *The final exhibit drawings are sufficiently detailed in order to fully document ultimate operation and appearance of the development. In addition to the new Stage II (Final) Planned Development permit request, an application for Site Design Review is being submitted concurrently and provides more detail of proposed design features.*

- E. Copies of legal documents required by the Development Review Board for dedication or reservation of public facilities, or for the creation of a non-profit homeowner's association, shall also be submitted.

**Applicant's Response:** *No formal dedications or reservations are proposed as part of this application. However, it is understand that as part of any future land*

***division or building development, that right-of-way along Printer Parkway will be dedicated to the City in accordance with the City Transportation Plan. The proposed development recognizes this requirements and has proposed development that will be compatible with the ultimately right-of-way location.***

- F. Within thirty (30) days after the filing of the final development plan, the Planning staff shall forward such development plan and the original application to the Tualatin Valley Fire and Rescue District, if applicable, and other agencies involved for review of public improvements, including streets, sewers and drainage. The Development Review Board shall not act on a final development plan until it has first received a report from the agencies or until more than thirty (30) days have elapsed since the plan and application were sent to the agencies, whichever is the shorter period.

**Applicant's Response: *The Owner/Applicant acknowledges the procedural requirements associated with the review process.***

***It should be noted that Tualatin Valley Fire and Rescue District was forwarded a copy of the preliminary site plan and building floor plan for initial review and comment.***

***Refer to Section D – Appendices, Appendix 22 – TVFR Land Use Review Application. As of the date of this submittal, no comments have been received from Tualatin Valley Fire and Rescue regarding the reconfiguration and expansion of the existing parking areas.***

- G. Upon receipt of the final development plan, the Development Review Board shall conduct a public hearing and examine such plan and determine:
- 1. Whether it conforms to all applicable criteria and standards; and**
  - 2. Whether it conforms in all substantial respects to the preliminary approval; or**
  - 3. Require such changes in the proposed development or impose such conditions of approval as are in its judgment necessary to insure conformity to the applicable criteria and standards.**

**Applicant's Response: *The final development plan conforms to the applicable criteria and the preliminary plan as detailed in this application.***

- H. If the Development Review Board permits the applicant to revise the plan, it shall be resubmitted as a final development plan within sixty (60) days. If the Board approves, disapproves or grants such permission to resubmit, the decision of the Board shall become final at the end of the appeal period for the decision, unless appealed to the City Council, in accordance with Sections 4.022 of this Code.

**Applicant's Response: *If necessary and allowed, the Owner/Applicant will resubmit the revised the new Stage II (Final) Planned Development permit within the timeframe specified by the Board.***

- I. All Stage II Site Development plan approvals shall expire two years after their approval date, if substantial development has not occurred on the property prior to that time. Provided, however, that the Development Review Board may extend these expiration times for up to three (3) additional periods of not more than one (1) year each. Applicants seeking time extensions shall make their requests in writing at least thirty (30) days in advance of the expiration date. Requests for time extensions shall only be granted upon (1) a showing that the applicant has in good faith attempted to develop or market the property in the preceding year or that development can be expected to occur within the next year, and (2) payment of any and all Supplemental Street SDCs applicable to the development. Upon such payment, the development shall have vested traffic generation rights under 4.140 (.10), provided however, that if the Stage II approval should expire, the vested right to use trips is terminated upon City repayment, without interest, of Supplemental Street SDCs. For purposes of this Ordinance, "substantial development" is deemed to have occurred if the required building permits or public works permits have been issued for the development, and the development has been diligently pursued, including the completion of all conditions of approval established for the permit.

**Applicant's Response: *The Owner/Applicant understands that all Stage II (Final) Planned Development permit approvals will expire two years after their approval date, if substantial development has not occurred or an extension requested.***

*[Amended by Ord 561, adopted 12/15/03.]*

- J. A planned development permit may be granted by the Development Review Board only if it is found that the development conforms to all the following criteria, as well as to the Planned Development Regulations in Section 4.140:
  1. The location, design, size and uses, both separately and as a whole, are consistent with the Comprehensive Plan, and with any other applicable plan, development map or Ordinance adopted by the City Council.

**Applicant's Response: *The subject property is located in the Planned Development Industrial (PDI) zoning district. Planned Development Industrial (PDI) zone is intended to provide for and accommodate a variety of industrial operations.***

***Uses within the Parkway Woods Business Park have slowly transitioned from manufacturing and research/development uses to more flex office/industrial uses. All of these uses are permitted und the PDI zone district.***

2. That the location, design, size and uses are such that traffic generated by the development at the most probable used intersection(s) can be accommodated safely and without congestion in excess of Level of Service D, as defined in the Highway Capacity Manual published by the National Highway Research Board, on existing or immediately planned arterial or collector streets and will, in the case of commercial or industrial developments, avoid traversing local streets. Immediately planned arterial and collector streets are those listed in the City's adopted Capital Improvement Program, for which funding has been approved or committed, and that are scheduled for completion within two years of occupancy of the development or four year if they are an associated crossing, interchange, or approach street improvement to Interstate 5.
  - a. In determining levels of Service D, the City shall hire a traffic engineer at the applicant's expense who shall prepare a written report containing the following minimum information for consideration by the Development Review Board:
    - i. An estimate of the amount of traffic generated by the proposed development, the likely routes of travel of the estimated generated traffic, and the source(s) of information of the estimate of the traffic generated and the likely routes of travel; *[Added by Ord. 561, adopted 12/15/03.]*
    - ii. What impact the estimate generated traffic will have on existing level of service including traffic generated by (1) the development itself, (2) all existing developments, (3) Stage II developments approved but not yet built, and (4) all developments that have vested traffic generation rights under section 4.140(.10), through the most probable used intersection(s), including state and county intersections, at the time of peak level of traffic. This analysis shall be conducted for each direction of travel if backup from other intersections will interfere with intersection operations. *[Amended by Ord 561, adopted 12/15/03.]*
  - b. The following are exempt from meeting the Level of Service D criteria standard:
    - i. A planned development or expansion thereof which generates three (3) new p.m. peak hour traffic trips or less;
    - ii. A planned development or expansion thereof which provides an essential governmental service.
  - c. Traffic generated by development exempted under this subsection on or after Ordinance No. 463 was enacted shall not be counted in determining levels of service for any future applicant. *[Added by Ord 561, adopted 12/15/03.]*
  - d. Exemptions under 'b' of this subsection shall not exempt the development or expansion from payment of system development charges or other applicable regulations. *[Added by Ord 561, adopted 12/15/03.]*

- e. In no case will development be permitted that creates an aggregate level of traffic at LOS "F". [Added by Ord 561, adopted 12/15/03.]

***Applicant's Response:*** *Since the proposed modifications do not include any new buildings or proposed expansions within the existing development, no new trips will be generated.*

3. That the location, design, size and uses are such that the residents or establishments to be accommodated will be adequately served by existing or immediately planned facilities and services.

***Applicant's Response:*** *The existing business park has been in existence for several years. The tenants and patrons of this development are already being adequately served by both public infrastructure and private services.*

- K. Mapping: Whenever a Planned Development permit has been granted, and so long as the permit is in effect, the boundary of the Planned Development shall be indicated on the Zoning Map of the City of Wilsonville as the appropriate "PD" Zone.

***Applicant's Response:*** *The site is zoned PD and indicated on the zoning map. Refer to Section D – Appendices, Appendix 5 – City of Wilsonville Zoning Map.*

- L. Adherence to Approved Plan and Modification Thereof: The applicant shall agree in writing to be bound, for her/himself and her/his successors in interest, by the conditions prescribed for approval of a development. The approved final plan and stage development schedule shall control the issuance of all building permits and shall restrict the nature, location and design of all uses. Minor changes in an approved preliminary or final development plan may be approved by the Director of Planning if such changes are consistent with the purposes and general character of the development plan. **All other modifications, including extension or revision of the stage development schedule, shall be processed in the same manner as the original application and shall be subject to the same procedural requirements.**

***Applicant's Response:*** *The proposal requires a modification of the Final Plan which will be considered in same fashion as the original Final Plan application.*

- M. In the event of a failure to comply with the approved plan or any prescribed condition of approval, including failure to comply with the stage development schedule, the Development Review Board may, after notice and hearing, revoke a Planned Development permit. General economic conditions that affect all in a similar manner may be considered as a basis for an extension of a development schedule. The determination of the Board shall become final thirty (30) days after the date of decision unless appealed to the City Council.

***Applicant's Response:*** *The Owner/Applicant understand that failure to comply with the approved plan or any prescribed condition of approval may result in the revoking a Planned Development permit.*



- (.10) Early Vesting of Traffic Generation. Applicants with Stage I or Master Plan approvals occurring after June 2, 2003 may apply to vest the right to use available transportation capacity at the intersections of Wilsonville Road with Boone’s Ferry Road and with Town Center Loop West, and/or the I-5 interchange. Vesting for properties with such approvals shall occur upon execution of a vesting agreement satisfactory to the city, which agreement shall include a proposed development schedule or phasing plan and either provide for the payment of any and all Supplemental Street SDCs or provide other means of financing public improvements. Vesting for properties pending such approvals shall occur upon such agreement and the date the approvals are final.

The number of trips vested is subject to modification based upon updated traffic analysis associated with subsequent development approvals for the property. A reduction in vested trips shall attend repayment of vesting fees by the City. An increase in available vested trips shall occur upon payment of necessary vesting fees.

Vesting shall remain valid and run with the property, unless an approval that is necessary for vesting to occur is terminated or a vesting agreement is terminated. If the vested right to use certain trips is lost or terminated, as determined by the Community Development Director with the concurrence of City Council, such trips shall be made available to other development upon City repayment, without interest, of associated vesting fees. *[Added by Ord. 561, adopted 12/15/03.]*

**Applicant’s Response: *Since the proposed modifications do not include any new buildings or proposed expansions within the existing development, no new trips will be generated.***

***Based on these circumstances, a Waiver for the completion of a Traffic Impact Study has been submitted. The City Engineer concurred with this position and has recommended approval of the Waiver. Refer to Section D – Appendices, Appendix 21 - Traffic Impact Study Waiver for additional information.***

## Use and Zone Specific Standards and Regulations

### Industrial Development Standards and Industrial Zoning

**Section Contains:**

**Section 4.117. Standards Applying To Industrial Developments In Any Zone**

**Section 4.135. PDI - Planned Development Industrial Zone**

**Section 4.117. Standards Applying To Industrial Developments In Any Zone.**

- (.01) All industrial developments, uses, or activities are subject to performance standards. If not otherwise specified in the Planning and Development Code, industrial developments, uses, and activities shall be subject to the performance standards specified in Section 4. 135 (.05) (PDI Zone).

***Applicant's Response:*** *In accordance with this section, all projects within industrial developments, uses, or activities are subject to performance standards as specified in Section 4.135.*

**Section 4.135. PDI - Planned Development Industrial Zone.**

- (.01) Purpose: The purpose of the PDI zone is to provide opportunities for a variety of industrial operations and associated uses.**

***Applicant's Response:*** *The Owner/Applicant understands that the purpose of the Planned Development Industrial (PDI) zone is intended to provide for and accommodate a variety of industrial operations.*

*Uses within the Parkway Woods Business Park have been slowly transitioning from manufacturing and research/development uses to more flex office/industrial uses. All of these uses are permitted und the PDI zone district.*

- (.02) The PDI Zone shall be governed by Section 4.140, Planned Development Regulations, and as otherwise set forth in this Code.

***Applicant's Response:*** *The Owner/Applicant understand that the uses and standards identified in the Planned Development Industrial Zone are governed by Section 4.140, Planned Development Regulations. The Owner/Applicant has demonstrated that the proposal is consistent with these regulations, above.*

- (.03) Uses that are typically permitted:

- A. Warehouses and other buildings for storage of wholesale goods, including cold storage plants.

- B. Storage and wholesale distribution of agricultural and other bulk products, provided that dust and odors are effectively contained within the site.
- C. Assembly and packing of products for wholesale shipment
- D. Manufacturing and processing
- E. Motor vehicle services, or other services complementary or incidental to primary uses, and which support the primary uses by allowing more efficient or cost-effective operations
- F. Manufacturing and processing of electronics, technical instrumentation components and health care equipment.**

**Applicant's Response:** *The Parkway Woods Business Park contains a number of tenants. 3D Systems, which is one of the current tenants, could be classified under this category of uses.*

- G. Fabrication

**H. Office complexes - Technology**

**Applicant's Response:** *Dealer Spike, one of the current tenants, would likely fall under this category of use.*

*It is anticipated that uses similar to this one would likely occupy portions of the remaining leasable space once it is converted to flex space.*

- I. Corporate headquarters

**Applicant's Response:** *While not currently a use located within the Parkway Woods Business Park development, this is one of many possible uses for the remaining leasable space.*

- J. Call centers

**K. Research and development**

**Applicant's Response:** *Again, 3D Systems, which is one of the current tenants, could fall under this category of uses.*

- L. Laboratories

- M. Repair, finishing and testing of product types manufactured or fabricated within the zone.

- N. Industrial services

- O. Any use allowed in a PDC Zone, subject to the following limitations:
1. Service Commercial uses (defined as professional services that cater to daily customers such as financial, insurance, real estate, legal, medical or dental offices) not to exceed 5000 square feet of floor area in a single building, or 20,000 square feet of combined floor area within a multi-building development.
  2. Office Complex Use (as defined in Section 4.001) shall not exceed 30% of total floor area within a project site.
  3. Retail uses, not to exceed 5000 square feet of indoor and outdoor sales, service or inventory storage area for a single building and 20,000 square feet of indoor and outdoor sales, service or inventory storage area for multiple buildings.
  4. Combined uses under Subsections 4.135(.03)(O.)(1.) and (3.) shall not exceed a total of 5000 square feet of floor area in a single building or 20,000 square feet of combined floor area within a multi-building development.
- P. Training facilities whose primary purpose is to provide training to meet industrial needs.
- Q. Public facilities.
- R. Accessory uses, buildings and structures customarily incidental to any permitted uses.

***Applicant's Response:*** *The Parkway Woods Business Park does contain a number of accessory uses that are intended to serve the tenants and their employees, visitors and other similar users. These include auditorium, conference rooms, exercise facilities and an outdoor plaza area. These types of uses would be considered accessory and intended to support the other primary uses.*

- S. Temporary buildings or structures for uses incidental to construction work. Such structures to be removed within 30 days of completion or abandonment of the construction work.

***Applicant's Response:*** *While there are no temporary buildings or structures currently on-site, it is anticipated that one or more temporary construction offices and material storage building may occur during the construction period. At the conclusion of construction period, these types of uses will be removed.*

- T. Other similar uses, which in the judgment of the Planning Director, are consistent with the purpose of the PDI Zone.

(.04) Block and access standards:

The PDI zone shall be subject to the same block and access standards as the PDC zone, Section 4.131(.02) and (.03).

**Applicant's Response: No new lots are being created as part of this application. The existing block standards will be unaffected by the proposed development.**

- (.05) Performance Standards. The following performance standards apply to all industrial properties and sites within the PDI Zone, and are intended to minimize the potential adverse impacts of industrial activities on the general public and on other land uses or activities. They are not intended to prevent conflicts between different uses or activities that may occur on the same property.
- A. All uses and operations except storage, off-street parking, loading and unloading shall be confined, contained, and conducted wholly within completely enclosed buildings, unless outdoor activities have been approved as part of Stage II, Site Design or Administrative Review.

**Applicant's Response: In accordance with this section, all uses and operations, except storage, off-street parking, loading and unloading will be conducted completely within enclosed building.**

***It should be noted that additional loading doors and adjacent loading areas are proposed as part of the improvements. These are necessary to improve the marketability of the available leasable area in the southwest and west portions of the building.***

***In addition, the plaza located on the south side of the building adjacent to the common area will be improved to provide some additional amenities serve the tenants and their employees, visitors and other similar users. These types of uses would be considered accessory and intended to support the other primary uses.***

- B. Vibration: Every use shall be so operated that the ground vibration inherently and recurrently generated from equipment other than vehicles is not perceptible without instruments at any boundary line of the property on which the use is located.

**Applicant's Response: None of the current or intended uses are expected to contain operations that produce ground vibrations.**

- C. Emission of odorous gases or other odorous matter in quantities as detectable at any point on any boundary line of the property on which the use is located shall be prohibited.

**Applicant's Response: None of the current or intended uses are expected contain uses that will result in the emission of odorous gasses.**

- D. Any open storage shall comply with the provisions of Section 4.176, and this Section.

**Applicant's Response: None of the current or intended uses contain exterior open storage.**

- E. No building customarily used for night operation, such as a baker or bottling and distribution station, shall have any opening, other than stationary windows or required fire exits, within one hundred (100) feet of any residential district and any space used for loading or unloading commercial vehicles in connection with such an operation shall not be within one hundred (100) feet of any residential district.

**Applicant's Response: None of the current or intended uses will be conducting night operations.**

- F. Heat and Glare:
  - 1. Operations producing heat or glare shall be conducted entirely within an enclosed building.
  - 2. Exterior lighting on private property shall be screened, baffled, or directed away from adjacent residential properties. This is not intended to apply to street lighting.

**Applicant's Response: None of the current or intended uses anticipate operations resulting from heat or glare.**

***Exterior parking area lighting will be shielded as to not disperse light on adjacent properties and will meet the minimum illumination levels at the property line.***

***For additional information, refer to Section C – Exhibit Drawings, Sheet 27 - Site Lighting Plan.***

- G. Dangerous Substances: Any use which involves the presence, storage or handling of any explosive, nuclear waste product, or any other substance in a manner which would cause a health or safety hazard for any adjacent land use or site shall be prohibited.

**Applicant's Response: None of the current or intended uses involve the presence of storage or handling of any explosive, nuclear waste product.**

- H. Liquid and Solid Wastes:
  - 1. Any storage of wastes which would attract insects or rodents or otherwise create a health hazard shall be prohibited.
  - 2. **Waste products which are stored outside shall be concealed from view from any property line by a sight-obscuring fence** or planting as required in Section 4.176.
  - 3. No connection with any public sewer shall be made or maintained in violation of applicable City or State standards.

4. No wastes conveyed shall be allowed to or permitted, caused to enter, or allowed to flow into any public sewer in violation of applicable City or State standards.
5. All drainage permitted to discharge into a street gutter, caused to enter or allowed to flow into any pond, lake, stream, or other natural water course shall be limited to surface waters or waters having similar characteristics as determined by the City, County, and State Department of Environmental Quality.
6. All operations shall be conducted in conformance with the City's standards and ordinances applying to sanitary and storm sewer discharges.

**Applicant's Response:** *All waste products which are stored outside are concealed from view from any property line. These types of activities are exclusively located in the loading areas where the solid waste and recycling collection areas are already existing. These are screened from view by a masonry walls. Due to the current orientation, they are not visible for the public right-of-way.*

- I. Noise: Noise generated by the use, with the exception of traffic noises from automobiles, trucks, and trains, shall not violate any applicable standards adopted by the Oregon Department of Environmental Quality and W.C. 6.204 governing noise control in the same or similar locations. *[Amended by Ord. 631, 7/16/07]*

**Applicant's Response:** *None of the current or intended uses are anticipated to generate noise.*

- J. Electrical Disturbances. Except for electrical facilities wherein the City is preempted by other governmental entities, electrical disturbances generated by uses within the PDI zone which interfere with the normal operation of equipment or instruments within the PDI Zone are prohibited. Electrical disturbances which routinely cause interference with normal activity in abutting residential use areas are also prohibited.

**Applicant's Response:** *None of the current or intended uses are anticipated to create electric disturbances.*

- K. Discharge Standards: There shall be no emission of smoke, fallout, fly ash, dust, vapor, gases, or other forms of air pollution that may cause a nuisance or injury to human, plant, or animal life, or to property. Plans of construction and operation shall be subject to the recommendations and regulations of the State Department of Environmental Quality. All measurements of air pollution shall be by the procedures and with equipment approved by the State Department of Environmental Quality or equivalent and acceptable methods of measurement approved by the City. Persons responsible for a suspected source of air pollution upon the request of the City shall provide quantitative and qualitative information regarding the discharge that will adequately and accurately describe operation conditions.

**Applicant's Response:** *None of the current or intended uses are anticipated to emission of smoke, fallout, fly ash, dust, vapor, gases, or other forms of air*

***pollution that may cause a nuisance or injury to human, plant, or animal life, or to property.***

L. Open burning is prohibited.

**Applicant's Response: *None of the current or intended uses will be allowed to participate in open burning.***

M. Storage:

1. Outdoor storage must be maintained in an orderly manner at all times.
2. Outdoor storage area shall be gravel surface or better and shall be suitable for the materials being handled and stored. If a gravel surface is not sufficient to meet the performance standards for the use, the area shall be suitably paved.
3. Any open storage that would otherwise be visible at the property line shall be concealed from view at the abutting property line by a sight obscuring fence or planting not less than six (6) feet in height.

**Applicant's Response: *None of the current or intended uses will be allowed to store equipment outside of their leasable space.***

N. Landscaping:

1. Unused property, or property designated for expansion or other future use, shall be landscaped and maintained as approved by the Development Review Board. Landscaping for unused property disturbed during construction shall include such things as plantings of ornamental shrubs, lawns, native plants, and mowed, seeded field grass.
2. Contiguous unused areas of undisturbed field grass may be maintained in their existing state. Large stands of invasive weeds such as Himalayan blackberries, English ivy, cherry Laurel, reed canary grass or other identified invasive plants shall be removed and/or mowed at least annually to reduce fire hazard. These unused areas, located within a phased development project or a future expansion cannot be included in the area calculated to meet the landscape requirements for the initial phase(s) of the development.
3. Unused property shall not be left with disturbed soils that are subject to siltation and erosion. Any disturbed soil shall be seeded for complete erosion cover germination and shall be subject to applicable erosion control standards.

**Applicant's Response: *In accordance with this section, all unused property, or property designated for expansion or other future use, will be landscaped. As part of the proposed development, 22.8% of the site will remain in a natural state or be landscaped.***



**Refer to Section C – Exhibit Drawings, Exhibit 16 – Landscape Plan - Overall (Preliminary), Exhibit 17 – Landscape Plan - Northwest Quadrant (Preliminary), Exhibit 18 – Landscape Plan - Northeast Quadrant (Preliminary), Exhibit 19 – Landscape Plan - Southwest Quadrant (Preliminary) and Exhibit 20 – Landscape Plans - Southeast Quadrant (Preliminary) for additional information.**

(.06) Other Standards:

- A. Minimum Individual Lot Size: No limit save and except as shall be consistent with the other provisions of this Code (e.g., landscaping, parking, etc.).

**Applicant's Response: While there are no land divisions proposed as part of this application, the Owner/Applicant acknowledges there is no minimum lot size if the subject property is subdivided or partitioned in the future.**

- B. Maximum Lot Coverage: No limit save and except as shall be consistent with the other provisions of this Code (e.g., landscaping, parking, etc.).

**Applicant's Response: While there is no maximum lot coverage, the City code does require a minimum landscape percentage of fifteen (15) percent. By default, this would mean that the maximum lot coverage would be 85% of the subject property. Currently, only 10.5% of the property is occupied by the existing building which is well below the maximum lot coverage.**

- C. Front Yard Setback: Thirty (30) feet. Structures on corner or through lots shall observe the minimum front yard setback on both streets. Setbacks shall also be maintained from the planned rights-of-way shown on any adopted City street plan.

**Applicant's Response: The existing building maintains frontage on three streets: SW Parkway Avenue (public), SW Printer Parkway (private) and SW Xerox Drive (private). It should be noted that SW Printer Parkway will likely be dedicated to the City as a part of future land division or development activity. In all situations, the minimum front yard setback have been exceeded.**

- D. Rear and Side Yard Setback: Thirty (30) feet. Structures on corner or through lots shall observe the minimum rear and side yard setbacks on both streets. Setbacks shall also be maintained from the planned rights-of-way shown on any adopted City street plan.

**Applicant's Response: The existing development exceeds the minimum thirty (30) requirement for rear and side setbacks.**

- E. No setback is required when side or rear yards abut on a railroad siding.

**Applicant's Response: There are no railroad tracks in the vicinity of the subject property.**

- F. Corner Vision: Corner lots shall have no sight obstruction to exceed the vision clearance standards of Section 4.177.

**Applicant's Response:** *Currently, there are two primary intersections within the proposed development. The first consists of the intersection of SW Parkway Avenue (public) and SW Printer Parkway (public). The second is the intersection of SW Parkway Avenue (public) and SW Xerox Drive (private).*

*Since no site work is proposed in the vicinity of either intersection, the corner vision/sight triangles will remain unaffected by the proposed improvements. However, at some point in the future, the existing monument signage may be replaced in accordance with the Sign Master Plan. Refer to the Sign Master Plan for new monument signage standards.*

*For additional information, refer to Section C – Exhibit Drawings, Sheet 04 – Site Plan - Overall (Preliminary) for compliance with the corner vision requirements.*

- G. Off-Street Parking and Loading: As provided in Section 4.155.

**Applicant's Response:** *As part of the parking area expansion and reconfiguration, all new development will be constructed in accordance with the off-street parking and loading standards identified in Section 4.155.*

*For additional information, refer to Section C – Exhibit Drawings, Sheet 04 – Site Plan – Overall (Preliminary) for compliance with the parking and loading requirements.*

- H. Signs: As provided in Sections 4.156.01 through 4.156.11.

*[Amended by Ord. No. 704, 6/18/12]*

**Applicant's Response:** *As part of the application submittal, the Owner/Application is requesting approval of a Sign Master Plan. Unless a deviation is approved by the Development Review Board, all signage will comply with Sections 4.156.01 through 4.156.11.*

*Refer to Section D – Appendices, Appendix 30 – Master Sign Plan for additional information.*

*[Section 4.135 amended by Ordinance No. 574, 11/1/04.]*

**Overlay Zones and Area Specific Regulations, including Design, Natural Resources, Interchange Area Traffic Management**

**Significant Resource Overlay Zone (SROZ)**

**Section Contains:**

- **Section 4.139.00**      **Significant Resource Overlay Zone (SROZ) Ordinance**
- **Section 4.139.01**      **SROZ – Purpose**
- **Section 4.139.02**      **Where These Regulations Apply**
- **Section 4.139.03**      **Administration**
- **Section 4.139.04**      **Uses and Activities Exempt from These Regulations**
- **Section 4.139.05**      **Significant Resource Overlay Zone Map Verification**
- **Section 4.139.06**      **Significant Resource Impact Report (SRIR) and Review Criteria**
- **Section 4.139.07**      **Mitigation Standards**
- **Section 4.139.08**      **Activities Requiring a Class I Administrative Review Process**
- **Section 4.139.09**      **Activities Requiring a Class II Administrative Review Process**
- **Section 4.139.10**      **Development Review Board (DRB) Process**
- **Section 4.139.11**      **Special Provisions**

**Section 4.139.00    Significant Resource Overlay Zone (SROZ) Ordinance**

**Definitions.**

***Applicant’s Response:*** *The Owner/Applicant acknowledges the terminology related to the application of the significant resource overlay zone (SROZ) code and uses this terminology in response to the criteria. For brevity, these definitions are not included in the application.*

**Section 4.139.01    SROZ - Purpose**

The Significant Resource Overlay Zone (SROZ) is intended to be used with any underlying base zone as shown on the City of Wilsonville Zoning Map. The purpose of the Significant Resource Overlay Zone is to implement the goals and policies of the Comprehensive Plan relating to natural resources, open space, environment, flood hazard, and the Willamette River Greenway. In addition, the purposes of these regulations are to achieve compliance with the requirements of the Metro Urban Growth Management Functional Plan (UGMFP) relating to Title 3 Water Quality Resource Areas, and Title 13 Habitat Conservation Areas, and that portion of Statewide Planning Goal 5 relating to significant natural resources. It is not the intent of this ordinance to prevent development where the impacts to significant resources can be minimized or mitigated. *[Amended by Ord. # 674 11/16/09]*

***Applicant’s Response:*** *The Owner/Applicant acknowledge that the purpose of the Significant Resource Overlay Zone (SROZ) is to achieve compliance with the requirements of the Metro Urban Growth Management Functional Plan (UGMFP) relating to Title 3 Water Quality Resource Areas.*

## Section 4.139.02 Where These Regulations Apply

**The regulations of this Section apply to the portion of any lot or development site, which is within a Significant Resource Overlay Zone and its associated “Impact Areas”.** The text provisions of the Significant Resource Overlay Zone ordinance take precedence over the Significant Resource Overlay Zone maps. The Significant Resource Overlay Zone is described by boundary lines shown on the City of Wilsonville Significant Resource Overlay Zone Map. For the purpose of implementing the provisions of this Section, the Wilsonville Significant Resource Overlay Zone Map is used to determine whether a Significant Resource Impact Report (SRIR) is required. Through the development of an SRIR, a more specific determination can be made of possible impacts on the significant resources.

Unless otherwise exempted by these regulations, any development proposed to be located within the Significant Resource Overlay Zone and/or Impact Area must comply with these regulations. Where the provisions of this Section conflict with other provisions of the City of Wilsonville Planning and Land Development Ordinance, the more restrictive shall apply.

The SROZ represents the area within the outer boundary of all inventoried significant natural resources. The Significant Resource Overlay Zone includes all land identified and protected under Metro’s UGMFP Title 3 Water Quality Resource Areas and Title 13 Habitat Conservation Areas, as currently configured, significant wetlands, riparian corridors, and significant wildlife habitat that is inventoried and mapped on the Wilsonville Significant Resource Overlay Zone Map. *[Amended by Ord. # 674 11/16/09]*

**Applicant’s Response: The Owner/Applicant understands that section apply to the portion of any lot or development site, which is within a Significant Resource Overlay Zone (SROZ) and its associated “Impact Areas”.**

***In order to implement the provisions of this Section, the Wilsonville Significant Resource Overlay Zone Map is used to determine whether a Significant Resource Impact Report (SRIR) is required. Refer to Section D – Appendices, Appendix 11 – Significant Resource Overlay Zone (SROZ) Map for a graphic illustration of the zone boundaries.***

***Based upon the SROZ map, there is a SROZ boundary along the eastern and southern boundary of the subject property. Due to the location of this boundary and proposed improvements, it was determined that a SRIR report would be required.***

***Refer to Section D – Appendices, Appendix 12 – Wetland Delineation Report and Appendix 13 - Significant Resource Impact Report (SRIR) for further information.***

## Section 4.139.03 Administration

(.01) Resources. The text provisions of this section shall be used to determine whether applications may be approved within the Significant Resource Overlay Zone. The following

maps and documents may be used as references for identifying areas subject to the requirements of this Section:

- A. Metro’s UGMFP Title 3 Water Quality Resource Area maps.
- B. The Federal Emergency Management Agency (FEMA) Flood Insurance Rate Maps (FIRM)
- C. The Wilsonville Local Wetland Inventory (LWI) (1998)
- D. The Wilsonville Riparian Corridor Inventory (RCI) (1998)
- E. Locally adopted studies or maps
- F. City of Wilsonville slope analysis maps
- G. Clackamas and Washington County soils surveys
- H. Metro’s UGMFP Title 13 Habitat Conservation Area Map *[Added by Ord. # 674 11/16/09]*

**Applicant’s Response: *The Owner/Applicant acknowledge the eight resource cited above in Items A-H were used to determine whether applications may be approved within the Significant Resource Overlay Zone.***

- (.02) Impact Area. The “Impact Area” is the area adjacent to the outer boundary of a Significant Resource within which development or other alteration activities may be permitted through the review of an SRIR (Significant Resource Impact Report). Where it can be clearly determined by the Planning Director that development is only in the Impact Area and there is no impact to the Significant Resource, development may be permitted without SRIR review. The impact area is 25 feet wide unless otherwise specified in this ordinance or by the decision making body. Designation of an Impact Area is required by Statewide Planning Goal 5. The primary purpose of the Impact Area is to ensure that development does not encroach into the SROZ.

**Applicant’s Response: *The Owner/Applicant understands that the “Impact Area” is defined as area adjacent to the outer boundary of a Significant Resource area within which development or other alteration activities may be permitted. For purposes of this application, the impact area is 25 feet in width.***

***Refer to Section D – Appendices, Appendix 13 - Significant Resource Impact Report (SRIR) for further information.***

- (.03) Significant Resource Impact Report (SRIR). For proposed non-exempt development within the SROZ, the applicant shall submit a Significant Resource Impact Report (SRIR) as part of any application for a development permit.

**Applicant’s Response: *In accordance with this section, the Owner/Applicant has prepared and submitted a copy of the Significant Resource Impact Report (SRIR).***

**Refer to Section D – Appendices, Appendix 13 - Significant Resource Impact Report (SRIR) for further information.**

- (.04) Prohibited Activities. New structures, development and construction activities shall not be permitted within the SROZ if they will negatively impact significant natural resources. Gardens, lawns, application of chemicals, uncontained areas of hazardous materials as defined by DEQ, domestic animal waste, dumping of materials of any kind, or other activities shall not be permitted within the SROZ if they will negatively impact water quality.

Unauthorized land clearing or grading of a site to alter site conditions is not allowed, and may result in the maximum requirement of mitigation/enhancement regardless of pre-existing conditions.

**Applicant's Response: The proposed improvements will affect one (1) small man-made drainage area (measuring approximately 412 square feet) in order to implement the expansion and reconfiguration of the circulation and parking areas. Based on the initial evaluation, the drainage swale is of low natural resource value and is certainly not considered significant based on its current condition. In order to facilitate the construction of a much needed loading area, this areas will be permitted and filled in accordance with local requirements. The Corp of Engineers has determined that the man-made drainage swale is not waters of the U.S. Similarly, the Oregon Department of State Lands will not be involved in the filling of the man-made drainage swale because the wetland requires less than 50 cubic yards of fill. Therefore, the City is the only agency that maintains jurisdiction over the man-made drainage swale.**

**Refer to Section D – Appendices, Appendix 12 – Wetland Delineation Report, Appendix 13 - Significant Resource Impact Report (SRIR), Appendix 14, Joint Cut/Fill Permit and Appendix 15 – Approved Jurisdictional Determination.**

- (.05) Habitat-Friendly Development Practices. To the extent practicable, development and construction activities that encroach within the Significant Resource Overlay Zone and/or Impact Area shall be designed, located and constructed to:
- A. Minimize grading, removal of native vegetation, disturbance and removal of native soils, and impervious area;
  - B. Minimize adverse hydrological impacts on water resources, such as using the practices described in Part (a) of Table NR-2, unless their use is prohibited by an applicable and required state or federal permit, such as a permit required under the federal Clean Water Act, 33 U.S.C. §§1251 et seq., or the federal Safe Drinking Water Act, 42 U.S.C. §§300f et seq., and including conditions or plans required by such permit;

C. Minimize impacts on wildlife corridors and fish passage, such as by using the practices described in Part (b) of Table NR-2; and

D. Consider using the practices described in Part (c) of Table NR-2.

[Section 4.139.03(.05) added by Ord. # 674 11/16/09]

**Table NR-2: Habitat-Friendly Development Practices**

<b>Part (A) Design and Construction Practices to Minimize Hydrologic Impacts</b>
1. Amend disturbed soils to original or higher level of porosity to regain infiltration and stormwater storage capacity.
2. Use pervious paving materials for residential driveways, parking lots and walkways.
3. Incorporate stormwater management in road right-of ways.
4. Landscape with rain gardens to provide on-lot detention, filtering of rainwater and groundwater re-charge.
5. Use green roofs for runoff reduction, energy savings, improved air quality, and enhanced aesthetics.
6. Disconnect downspouts from roofs and direct the flow to vegetated infiltration/filtration areas such as rain gardens.
7. Retain rooftop runoff in a rain barrel for later on-lot use in lawn and garden watering.
8. Use multi-functional open drainage systems in lieu of more conventional curb and gutter systems.
9. Use bioretention cells as rain gardens in landscaped parking lot islands to reduce runoff volume and filter pollutants.
10. Apply a treatment train approach to provide multiple opportunities for storm water treatment and reduce the possibility of system failure.
11. Reduce sidewalk width and grade them such that they drain to the front yard of a residential lot or retention area.
12. Reduce impervious impacts of residential driveways by narrowing widths and moving access to the rear of the site.
13. Use shared driveways.
14. Reduce width of residential streets, depending on traffic and parking needs.
15. Reduce street length, primarily in residential areas, by encouraging clustering and using curvilinear designs.
16. Reduce cul-de-sac radii and use pervious vegetated islands in center to minimize impervious effects, and allow them to be utilized for truck maneuvering/loading to reduce need for wide loading areas on site.
16. Minimize car spaces and stall dimensions, reduce parking ratios, and use shared parking facilities and structured parking.
17. Minimize the number of stream crossings and place crossing perpendicular to stream channel, if possible.
18. Allow narrow street right-of-ways through stream corridors whenever possible to reduce adverse impacts of transportation corridors.
<b>Part (B) Design and Construction Practices to Minimize Impacts on Wildlife Corridors and Fish Passage</b>
1. Carefully integrate fencing into the landscape to guide animals toward animal crossings under, over, or around transportation corridors.
2. Use bridge crossings rather than culverts, wherever possible.
3. If culverts are utilized, install slab, arch or box type culverts, preferably using bottomless designs that more closely mimic stream bottom habitat.
4. Design stream crossings for fish passage with shelves and other design features to facilitate terrestrial wildlife passage.
5. Extend vegetative cover through the wildlife crossing in the migratory route, along with sheltering areas.
<b>Part (C) Miscellaneous Other Habitat Friendly Design and Construction Practices</b>
1. Use native vegetation throughout the development.
2. Locate landscaping adjacent to SROZ.

3. Reduce light spill-off into SROZ areas from development.
4. Preserve and maintain existing trees and tree canopy coverage, and plant trees, where appropriate, to maximize future tree canopy coverage.

[Added by Ord. # 674 11/16/09]

***Applicant’s Response:*** *In accordance with this section, the Owner/Applicant will, to the extent practicable, will utilize habitat friendly development practices to development and construction activities that could potentially impact the area within the Significant Resource Overlay Zone and/or Impact Area.*

*Aside from the filling of the small wetland area, the Owner/Applicant is proposing to enhance a portion of the buffer along the eastern edge of the property which is located in the Significant Resource Overlay Zone.*

**Section 4.139.04 Uses and Activities Exempt from These Regulations**

A request for exemption shall be consistent with the submittal requirements listed under Section 4.139.06(.01)(B – I), as applicable to the exempt use and activity. [Added by Ord. # 674 11/16/09]

- (.01) Emergency procedures or emergency activities undertaken which are necessary for the protection of public health, safety, and welfare. Measures to remove or abate hazards and nuisances. Areas within the SROZ that are disturbed because of emergency procedures or activities should be repaired and mitigated.
- (.02) Maintenance and repair of buildings, structures, yards, gardens or other activities or uses that were in existence prior to the effective date of these regulations.
- (.03) Alterations of buildings or accessory structures which do not increase building coverage.
- (.04) The following agricultural activities lawfully in existence as of the effective date of this ordinance:
  - A. Mowing of hay, grass or grain crops.
  - B. Tilling, disking, planting, seeding, harvesting and related activities for pasture, tree crops, commercial woodlots, food crops or business crops, provided that no additional lands within the SROZ are converted to these uses after the effective date of this ordinance.
- (.05) Operation, maintenance, and repair of irrigation and drainage ditches, constructed ponds, wastewater facilities, stormwater detention or retention facilities, and water facilities consistent with the Stormwater Master Plan or the Comprehensive Plan.
- (.06) Maintenance and repair of streets and utility services within rights-of way, easements, access drives or other previously improved areas. [Amended by Ord. 682, 9/9/10]



- (.07) Normal and routine maintenance and repair of any public improvement or public recreational area regardless of its location.
- (.08) The construction of new roads, pedestrian or bike paths into the SROZ in order to provide access to the sensitive area or across the sensitive area, provided the location of the crossing is consistent with the intent of the Wilsonville Comprehensive Plan. Roads and paths shall be constructed so as to minimize and repair disturbance to existing vegetation and slope stability.
- (.09) Maintenance and repair of existing railroad tracks and related improvements.
- (.10) The removal of invasive vegetation such as Himalayan Blackberry, English Ivy, Poison Oak, Scots (Scotch) Broom or as defined as invasive in the Metro Native Plant List.**
- (.11) The planting or propagation of any plant identified as native on the Metro Native Plant List. See Wilsonville Planning Division to obtain a copy of this list.
- (.12) Grading for the purpose of enhancing the Significant Resource as approved by the City.
- (.13) Enhancement of the riparian corridor or wetlands for water quality or quantity benefits, fish, or wildlife habitat as approved by the City and other appropriate regulatory authorities.**
- (.14) Flood control activities pursuant to the Stormwater Master Plan, save and except those stormwater facilities subject to Class II Administrative Review, as determined by the Planning Director, to ensure such facilities meet applicable standards under federal, state and local laws, rules and regulations.
- (.15) Developments that propose a minor encroachment into the Significant Resource Overlay Zone. The purpose of this adjustment would be to allow for minor encroachments of impervious surfaces such as accessory buildings, eave overhangs, building appurtenances, building access and exiting requirements or other similar feature. The total adjustment shall not exceed 120 square feet in cumulative area.
- (.16) The expansion of an existing single family dwelling not exceeding 600 square feet in area. The expansion of an existing single family dwelling or structures that are accessory to a single family dwelling inside the SROZ, provided that the following criteria have been satisfied. An SRIR is not required to evaluate and reach a decision on the issuance of a permit to expand a single-family residence under this paragraph.
  - A. The expansion of a single family structure or improvement (including decks and patios) shall not be located any closer to the stream or wetland area than the existing structure or improvement; and
  - B. The coverage of all structures within the SROZ on the subject parcel shall not be increased by more than 600 square feet, based on the coverage in existence prior to the effective date of this ordinance; and,

- C. The applicant must obtain the approval of an erosion and sediment control plan from the City's Building and Environmental Services Divisions; and,
  - D. No part of the expansion is located within the Metro UGMFP Title 3 Water Quality Area.
- (.17) New Single-Family Dwelling. The construction of a new single family dwelling is exempt unless the building encroaches into the Impact Area and/or the SROZ.
- A. If the proposed building encroaches only into the Impact Area then an abbreviated SRIR may be required as specified in Section 4.139.05, unless it can be clearly determined by the Planning Director that the development proposal will have no impact on the Significant Resource. The primary purpose of the Impact Area is to insure that development does not encroach into the SROZ. Development otherwise in compliance with the Planning and Land Development Ordinance may be authorized within the Impact Area.
  - B. If the proposed building encroaches into the SROZ, then a complete or abbreviated SRIR report is required.
- (.18) Private or public service connection laterals and service utility extensions.
- (.19) A Stage II development permit or other development permits issued by the City and approved prior to the effective date of this ordinance.
- (.20) The installation of public streets and utilities specifically mapped within a municipal utility master plan, the Transportation Systems Plan or a capital improvement plan.
- (.21) Structures which are non-conforming to the standards of this Section may be re-built in the event of damage due to fire or other natural hazard subject to Sections 4.189 – 4.192 of the Planning and Land Development Ordinance, provided that the structure is placed within the same foundation lines (See Figure NR-6.). An SRIR is not required to evaluate and reach a decision on the issuance of a permit to replace a structure subject to this paragraph.

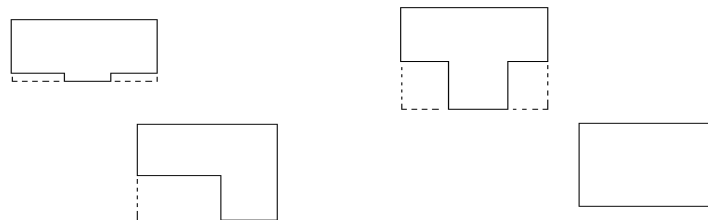

**Figure NR-6. Building Line Examples**

- (.22) Any impacts to resource functions from the above excepted activities, such as gravel construction pads, erosion/sediment control materials or damaged vegetation, shall be mitigated using appropriate repair or restoration/enhancement techniques.

***Applicant's Response:*** *Generally, activities associated with the proposed improvements do not qualify for an exemption under this section of the code. However, there may be some invasive vegetation removal and restoration efforts for the purpose of enhancing the Significant Resource area that could qualify provided they receive approval from the City.*

#### **Section 4.139.05 Significant Resource Overlay Zone Map Verification**

**The map verification requirements described in this Section shall be met at the time an applicant requests a building permit, grading permit, tree removal permit, land division approval, or other land use decision.** Map verification shall not be used to dispute whether the mapped Significant Resource Overlay Zone boundary is a significant natural resource. Map refinements are subject to the requirements of Section 4.139.10(.01)(D).

- (.01) In order to confirm the location of the Significant Resource Overlay Zone, map verification shall be required or allowed as follows:
- A. Development that is proposed to be either in the Significant Resource Overlay Zone or less than 100 feet outside of the boundary of the Significant Resource Overlay Zone, as shown on the Significant Resource Overlay Zone Map.
  - B. A lot or parcel that:
    - 1. Either contains the Significant Resource Overlay Zone, or any part of which is less than 100 feet outside the boundary of the Significant Resource Overlay Zone, as shown on the Significant Resource Overlay Zone Map; and
    - 2. Is the subject of a land use application for a partition, subdivision, or any land use application that the approval of which would authorize new development on the subject lot or parcel.**

***Applicant's Response:*** *The Owner/Applicant is requesting a map verification in association with a Type II (Final) Planned Development (modification), Site Design Review, Tree Removal Permit (Type C) and a Sign Master Plan.*

- (.02) An application for Significant Resource Overlay Zone Map Verification may be submitted even if one is not required pursuant to Section 4.139.05(.01).

***Applicant's Response:*** *A verification is required since the property contains a City SROZ mapped boundary and the Owner/Applicant is requesting a land use decision authorizing development on the property.*

- (.03) If a lot or parcel or parcel is subject to Section 4.139.05(.01), an application for Significant Resource Overlay Zone Map Verification shall be filed concurrently with the other land use applications referenced in Section 4.139.05(.01)(B)(2) unless a previously approved Significant Resource Overlay Zone Map Verification for the subject property remains valid.**

**Applicant's Response:** *In accordance with this section, an application for Significant Resource Overlay Zone Map Verification will be filed concurrently with the other land use applications referenced in Section 4.139.05.*

*In this particular case, the SROZ verification is being concurrently with the following application:*

- *Stage II (Final) Planned Development (modification)*
- *Site Design Review*
- *Tree Permit (Type C)*
- *Sign Master Plan*

*The required narrative for each of these applications is contained in this submittal.*

(.04) An applicant for Significant Resource Overlay Zone Map Verification shall use one or more of the following methods to verify the Significant Resource Overlay Zone boundary:

A. The applicant may concur with the accuracy of the Significant Resource Overlay Zone Map of the subject property;

**Applicant's Response:** *Based on the on-site conditions, the Owner/Applicant does not concur with the accuracy of the existing mapped Significant Resource Overlay Zone (SROZ) Map as it is illustrated on the subject property.*

**B. The applicant may demonstrate a mapping error was made in the creation of the Significant Resource Overlay Zone Map;**

**Applicant's Response:** *The Owner/Applicant believes that the generalized boundary of the Significant Resource Overlay Zone (SROZ) Map is inaccurate. Based on this, the Owner/Applicant commissioned the preparation of a Significant Resource Impact Report (SRIR) which included a delineation of the resource boundary.*

*Refer to Section D – Appendices, Appendix 13 - Significant Resource Impact Report (SRIR) for further information*

C. The applicant may demonstrate that the subject property was developed lawfully prior to June 7, 2001.

**Applicant's Response:** *While the original building was constructed prior to June 7, 2001, the area proposed for expansion is outside the original building and parking footprint.*

(.05) The Planning Director shall determine the location of any Significant Resource Overlay Zone on the subject property by considering information submitted by the applicant, information collected during any site visit that may be made to the subject property, information

generated by Significant Resource Overlay Zone Map Verification that has occurred on adjacent properties, and any other relevant information that has been provided.

***Applicant's Response:*** *The Owner/Applicant acknowledges that Planning Director will determine the location of any Significant Resource Overlay Zone (SROZ) on the subject property by considering information submitted by the applicant, information collected during any site visit that may be made to the subject property, information generated by Significant Resource Overlay Zone Map Verification that has occurred on adjacent properties, and any other relevant information that has been provided.*

(.06) For applications filed pursuant to Section 4.139.05(.04)(A) and (C), a Significant Resource Overlay Zone Map Verification shall be consistent with the submittal requirements listed under Section 4.139.06(.01)(B-H).

***Applicant's Response:*** *The Significant Resource Overlay Zone (SROZ) map verification application will be filed pursuant to Section 4.139.05(.04)(B.)*

(.07) For applications filed pursuant to Section 4.139.05(.04)(B), a Significant Resource Overlay Zone Map Verification shall be consistent with the submittal requirements listed under Section 4.139.06(.02)(D)(1).

***Applicant's Response:*** *In accordance with this section, the Significant Resource Overlay Zone (SROZ) Map Verification will be consistent with the submittal requirements listed under Section 4.139.06(.02)(D)(1)*

[Section 4.139.05 added by Ord. # 674 11/16/09]

#### **Section 4.139.06 Significant Resource Impact Report (SRIR) and Review Criteria**

A Significant Resource Impact Report (SRIR) is a report that delineates specific resource boundaries and analyzes the impacts of development within mapped significant resource areas based upon the requirements of this Section. An SRIR is only required for non-exempt development that is located within the Significant Resource Overlay Zone and/or its associated 25 foot Impact Area.

The Significant Resource Overlay Zone Map identifies areas that have been classified as significant natural resources. The preparation of the Significant Resource Overlay Zone Map did not include specific field observations of every individual property. These maps are designed to be specific enough to determine whether further environmental review of a development proposal is necessary. If any portion of the development or alteration of the land (except those exempted by this Section) is located within the Significant Resource Overlay Zone boundary or the identified Impact Area, then an SRIR is required before any development permit can be issued. Where it can be clearly determined by the Planning Director that development is only in the Impact Area and there is no impact to the Significant Resource, development may be permitted without SRIR review.

The Planning Director may consult with a professional with appropriate expertise to evaluate an applicant's SRIR prepared under this Section or may rely on appropriate staff expertise, in order to properly evaluate the report's conclusions.

- (.01) Abbreviated SRIR Requirements. ***This criterion is not applicable to this application since the Significant Resource Overlay Zone Map Verification will be consistent with the Standard submittal requirements listed under Section 4.139.06(.02)(D)(1).***
  
- (.02) Application Requirements for a Standard SRIR. The following requirements must be prepared and submitted as part of the SRIR evaluation for any development not included in paragraph A above:
  - A. A Site Development Permit Application must be submitted in compliance with the Planning and Land Development Ordinance.
  - B. The SRIR shall be conducted and prepared by a natural resource professional knowledgeable and qualified to complete such a report.
  - C. The qualifications of the person or persons preparing each element of the analysis shall be included with the SRIR.
  - D. The SRIR shall include the following:
    - 1. Physical Analysis.** The analysis shall include, at a minimum:
      - a. Soil types;
      - b. Geology;
      - c. Hydrology of the site;
      - d. Outline of any existing features including, but not limited to, structures, decks, areas previously disturbed, and existing utility locations;
      - e. Location of any wetlands or water bodies on the site and the location of the stream centerline and top-of-bank.
      - f. Within the area proposed to be disturbed, the location, size and species of all trees that are more than six (6) inches DBH. Trees outside the area proposed to be disturbed may be individually shown or shown as drip line with an indication of species type or types;
      - g. A property survey together with topography shown by contour lines prepared at two-foot vertical intervals. Five-foot vertical intervals may be allowed for steep sloped areas. The survey shall be prepared by an Oregon Registered Land Surveyor or Civil Engineer.
      - h. The location of the SROZ and Impact Area boundaries;

- i. A minimum of three slope cross-section measurements transecting the site, equally spaced at no more than 100-foot increments. The measurements should be made perpendicular to the stream;
- j. A map that delineates the Metro UGMFP Title 3 Water Quality Resource Area boundary (using Metro Title 3 field observed standards);
- k. A map that delineates the Goal 5 safe harbor boundary (using the standards found within the Oregon Administrative Rule OAR 660-23(1996));
- l. The existing site significant resource conditions shall be determined and identified by a natural resource professional; and
- m. Current photos of site conditions shall be provided to supplement the above information.

**2. The analysis shall include development recommendations** including grading procedures, soil erosion control measures, slope stabilization measures, and methods of mitigating hydrologic impacts. For projects that affect possible wetlands, a copy of the Local Wetland Inventory (LWI) map pertaining to the site shall be provided. Notice of the proposal shall be given to the Oregon Division of State Lands and the Army Corp of Engineers.

**3. Ecological Analysis.** The Ecological Analysis shall include a map, using the Physical Analysis map as a base, showing the delineated boundaries and coverage of wetlands, riparian corridors, and wildlife habitat resources identified on the site.

- a. Wetland boundaries shall be delineated using the method currently accepted by the Oregon Division of State Lands and the US Army Corps of Engineers. Riparian boundaries shall be delineated using the riparian corridor descriptions in this ordinance. Boundaries of mapped Goal 5 wildlife habitat shall be verified by field observation.
- b. The analysis shall include an inventory that lists and describes the native and ornamental dominant and sub-dominant groundcover, shrub and tree species occurring on the site and wildlife observed during at least one site visit (specify date). The report shall also include recommended measures for minimizing the adverse impacts of the proposed development on unique and/or significant features of the ecosystem. The analysis shall include a report that discusses the ecological functions and values of the SROZ area, discussing each parameter listed below. The discussion shall be based on actual field observations and data obtained by a natural resource professional.
- c. Wetlands (based on evaluation criteria in the Oregon Freshwater Wetlands Assessment Methodology (OFWAM), Oregon Division of State Lands)
  - i. wildlife habitat diversity

- ii. fish habitat
- iii. water quality protection
- iv. hydrologic control
- d. Wildlife Habitat (includes riparian corridors and upland forested areas)
  - i. wildlife habitat diversity
  - ii. water quality protection
  - iii. ecological integrity
  - iv. connectivity
  - v. uniqueness
- e. Riparian Corridors Stream-riparian ecosystems:
  - i. Presence and abundance of Large Woody Debris (LWD) in and adjacent to stream
  - ii. Tree/shrub canopy stream shade production (water temperature and aquatic plant growth control)
  - iii. Erosion and sediment control by riparian vegetation
  - iv. Water quality protection by riparian vegetation
  - v. River-floodplain ecosystem (Willamette River)
  - vi. Presence of functional floodplain (inundated annually)
  - vii. Type and condition of functional floodplain vegetation
  - viii. Use of river-floodplain by ESA-listed species
  - ix. Role as wildlife corridor connecting significant wildlife habitat areas

**4. Mitigation and Enhancement Proposal.** The applicant must propose a Significant Resource mitigation and enhancement plan as part of the SRIR. The mitigation and enhancement shall increase the natural values and quality of the remaining Significant Resource lands located on the site or other location as approved by the City. The mitigation and enhancement proposal shall conform to the mitigation standards identified in this Section.



5. Waiver of Documentation: The Planning Director may waive the requirement that an SRIR be prepared where the required information has already been made available to the City, or may waive certain provisions where the Director determines that the information is not necessary to review the application. Such waivers may be appropriate for small-scale developments and shall be processed under Administrative Review. Where such waivers are granted by the Planning Director, the Director shall clearly indicate the reasons for doing so in the record, citing the relevant information relied upon in reaching the decision.

**Applicant's Response:** *In accordance with this section, the Owner/Applicant has prepared and submitted a copy of the Significant Resource Impact Report (SRIR).*

***Refer to Section D – Appendices, Appendix 13 - Significant Resource Impact Report (SRIR) for further information.***

***Also, refer to Section C – Exhibit Drawings, Sheet 03 – On-Site Analysis Plan – Overall (Preliminary) for additional information.***

- (.03) SRIR Review Criteria. In addition to the normal Site Development Permit Application requirements as stated in the Planning and Land Development Ordinance, the following standards shall apply to the issuance of permits requiring an SRIR. The SRIR must demonstrate how these standards are met in a manner that meets the purposes of this Section.

- A. Except as specifically authorized by this code, development shall be permitted only within the Area of Limited Conflicting Use (see definition) found within the SROZ;

**Applicant's Response:** *The Owner/Applicant understands that the development will be permitted only within the Area of Limited Conflicting Use. In this particular case, the area of conflicting use is limited to the area where the Owner/Applicant are proposing a new loading area to serve the southwestern portion of the building. No other impacts are proposed within the proposed SROZ boundary.*

- B. Except as specifically authorized by this code, no development is permitted within Metro's Urban Growth Management Functional Plan Title 3 Water Quality Resource Areas boundary;

**Applicant's Response:** *Again, the area of proposed development is limited to a small drainage swale between the existing building and SW Xerox Drive.*

***Refer to Section D – Appendices, Appendix 13 - Significant Resource Impact Report (SRIR) for further information.***

- C. No more than five (5) percent of the Area of Limited Conflicting Use (see definition) located on a property may be impacted by a development proposal. On properties that are large enough to include Areas of Limited Conflicting Use on both sides of a waterway, no more than five (5) percent of the Area of Limited Conflicting Use on each

side of the riparian corridor may be impacted by a development proposal. This condition is cumulative to any successive development proposals on the subject property such that the total impact on the property shall not exceed five (5) percent;

**Applicant's Response:** *For the most part, the proposed development will not impact more than five percent of the area of limited conflicting use. However, in one particular area, the Owner/Applicant is proposing to remove a small man-made drainage way in order to accommodate a loading area for shipping/receiving on the south side of the building. In this particular situation, the Owner/Applicant is proposing to mitigate through the restoration and enhancement of the buffer area located adjacent to a seasonal drainage situated along the eastern property line.*

*Refer to Section D – Appendices, Appendix 13 - Significant Resource Impact Report (SRIR) for further information.*

- D. Mitigation of the area to be impacted shall be consistent with Section 4.139.06 of this code and shall occur in accordance with the provisions of this Section;

**Applicant's Response:** *As necessary, mitigation for impacts to the identified resource may be required. However, given the relatively small size (412 square feet in size), the Owner/Applicant are proposing to mitigate through the restoration and enhancement of the buffer area located adjacent to a seasonal drainage situated along the eastern property line.*

*Refer to Section D – Appendices, Appendix 13 - Significant Resource Impact Report (SRIR) for further information.*

- E. The impact on the Significant Resource is minimized by limiting the degree or magnitude of the action, by using appropriate technology or by taking affirmative steps to avoid, reduce or mitigate impacts;

**Applicant's Response:** *In order to provide a much needed loading area on the south side of the building, impacts to a small wetland area unavoidable. However, the Owner/Applicant have taken into consideration the presence of natural resources on the remainder of the site. In fact, the expansion of the surface parking lot on the southeast portion of the property as gone through several iterations in order to avoid potential impacts of wetlands and significant tree species.*

*Refer to Section D – Appendices, Appendix 13 - Significant Resource Impact Report (SRIR) for further information.*

- F. The impacts to the Significant Resources will be rectified by restoring, rehabilitating, or creating enhanced resource values within the “replacement area” (see definitions) on the site or, where mitigation is not practical on-site, mitigation may occur in another location approved by the City;

**Applicant's Response:** *The forested wetland in the SE corner of the property will be protected by a 50' buffer which will be enhanced with appropriate plantings to improve the quality of buffer protecting the resource.*

***Refer to Section D – Appendices, Appendix 13 - Significant Resource Impact Report (SRIR) for further information.***

- G. Non-structural fill used within the SROZ area shall primarily consist of natural materials similar to the soil types found on the site;

**Applicant's Response:** *With the exception of the small area proposed for fill, non-structural fill in the SROZ boundary will be limited to natural materials.*

- H. The amount of fill used shall be the minimum required to practically achieve the project purpose;

**Applicant's Response:** *The amount of fill material will consist of the minimum amount necessary to meet the Owner/Applicants objectives.*

- I. Other than measures taken to minimize turbidity during construction, stream turbidity shall not be significantly increased by any proposed development or alteration of the site;

**Applicant's Response:** *No streams or water bodies will be affected by the proposed improvements to the Parkway Woods Business Park.*

- J. Appropriate federal and state permits shall be obtained prior to the initiation of any activities regulated by the U.S. Army Corps of Engineers and the Oregon Division of State Lands in any jurisdictional wetlands or water of the United States or State of Oregon, respectively.

**Applicant's Response:** *The Corp of Engineers has determined that the man-made drainage swale is not waters of the U.S. Similarly, the Oregon Department of State Lands will not be involved in the filling of the man-made drainage swale because the wetland requires less than 50 cubic yards of fill. Therefore, the City is the only agency that maintains jurisdiction over the man-made drainage swale.*

***Refer to Section D – Appendices, Appendix 12 – Wetland Delineation Report, Appendix 13 - Significant Resource Impact Report (SRIR), Appendix 14, Joint Cut/Fill Permit and Appendix 15 – Approved Jurisdictional Determination.***

#### **Section 4.139.07 Mitigation Standards**

The following mitigation standards apply to significant wildlife habitat resource areas for encroachments within the Area of Limited Conflicting Uses and shall be followed by those proposing

such encroachments. **Wetland mitigation shall be conducted as per permit conditions from the US Army Corps of Engineers and Oregon Division of State Lands. While impacts are generally not allowed in the riparian corridor resource area, permitted impacts shall be mitigated by: using these mitigation standards if the impacts are to wildlife habitat values; and using state and federal processes if the impacts are to wetland resources in the riparian corridor.** Mitigation is not required for trees lost to a natural event such as wind or floods.

- (.01) The applicant shall review the appropriate Goal 5 Inventory Summary Sheets for wildlife habitat (i.e. upland) contained in the City of Wilsonville Natural Resource Inventory and Goal 5/Title 3/ESA Compliance and Protection Plan (“Compliance and Protection Plan”- May 2000) to determine the resource function ratings at the time the inventory was conducted.
- (.02) The applicant shall prepare a Mitigation Plan document containing the following elements:
  - A. The Mitigation Plan shall contain an assessment of the existing natural resource function ratings at the time of the proposed encroachment for the site compared to the function ratings recorded in the Compliance and Protection Plan.
  - B. The Mitigation Plan shall contain an assessment of the anticipated adverse impacts to significant wildlife habitat resources. The impact assessment shall discuss impacts by resource functions (as listed in the Compliance and Protection Plan, May 2000) for each resource type, and shall map the area of impact (square feet or acres) for each function.
  - C. The Mitigation Plan shall present a proposed mitigation action designed to replace the lost or impacted resource functions described in Subsection B, above. The mitigation plan shall be designed to replace lost or impacted functions by enhancement of existing resources on, or off the impact site, or creation of new resource areas.
  - D. For mitigation projects based on resource function enhancement, the area ratios presented in Table NR - 2 shall be applied. These ratios are based on the resource function ratings at the time of the proposed action, as described in Subsection A, above. The mitigation action shall be conducted on the appropriate size area as determined by the ratios in Table NR - 2.
  - E. The Mitigation Plan shall include a planting plan containing the following elements:
    - 1. Required Plants and Plant Densities. All trees, shrubs and ground cover shall be native vegetation. An applicant shall comply with Section 4.139.06(.02)(E)(1)(a) or (b), whichever results in more tree plantings, except where the disturbance area is one acre or more, the applicant shall comply with Section 4.139.06(.02)(E)(1)(b).
      - a. The mitigation requirement shall be calculated based on the number and size of trees that are removed from the site. Trees that are removed from the site shall be replaced as shown in Table NR – 3. Conifers shall be replaced with conifers. Bare ground shall be planted or seeded with native grasses or herbs.

**Table NR – 3: Tree Replacement Requirements**

Size of Tree to be Removed (inches in diameter at breast height)	Number of Trees and Shrubs to be Planted
6 to 12	2 trees and 3 shrubs
over 12 to 18	3 trees and 6 shrubs
over 18 to 24	5 trees and 12 shrubs
over 24 to 30	7 trees and 18 shrubs
over 30	10 trees and 30 shrubs

- b. The mitigation requirement shall be calculated based on the size of the disturbance within the Significant Resource Overlay Zone. Native trees and shrubs shall be planted at a rate of five (5) trees and twenty-five (25) shrubs per every 500 square feet of disturbance area (calculated by dividing the number of square feet of disturbance area by 500, and then multiplying that result times five (5) trees and twenty-five (25) shrubs, and rounding all fractions to the nearest whole number of trees and shrubs; for example, if there will be 330 square feet of disturbance area, then 330 divided by 500 equals 0.66, and 0.66 times five equals 3.3, so three (3) trees shall be planted, and 0.66 times twenty-five (25) equals 16.5, so seventeen (17) shrubs shall be planted). Bare ground shall be planted or seeded with native grasses or herbs.
2. Plant Size. Replacement trees and shrubs shall be at least one-gallon in size and shall be at least twelve (12) inches in height.
  3. Plant Spacing. Trees shall be planted between eight (8) and twelve (12) feet on center, and shrubs shall be planted between four (4) and five (5) feet on center, or clustered in single species groups of no more than four (4) plants, with each cluster planted between eight (8) and ten (10) feet on center. When planting near existing trees, the drip line of the existing tree shall be the starting point for plant spacing measurements.
  4. Plant Diversity. Shrubs shall consist of at least two (2) different species. If five (5) trees or more are planted, then no more than fifty (50) percent of the trees may be of the same genus.
  5. Invasive Vegetation. Invasive non-native or noxious vegetation shall be removed within the mitigation area prior to planting, and shall be removed or controlled for five (5) years following the date that the mitigation planting is completed.
  6. Mulching and Browse Protection. Mulch shall be applied around new plantings at a minimum of three inches in depth and eighteen inches in diameter. Browse protection shall be installed on trees and shrubs. Mulching and browse protection shall be maintained during the two-year plant establishment period.
  7. Tree and Shrub Survival. Trees and shrubs that die shall be replaced in kind to the extent necessary to ensure that a minimum of eighty (80) percent of the trees and

shrubs initially required shall remain alive on the fifth anniversary of the date that the mitigation planting is completed. *[Section 4.139.07(.02)(E.) added by Ord. # 674 11/16/09]*

- (.03) Proposals for mitigation action where new natural resource functions and values are created (i.e. creating wetland or wildlife habitat where it does not presently exist) will be reviewed and may be approved by the Development Review Board or Planning Director if it is determined that the proposed action will create natural resource functions and values that are equal to or greater than those lost by the proposed impact activity.
- (.04) Mitigation actions shall be implemented prior to or at the same time as the impact activity is conducted.
- (.05) Mitigation plans shall have clearly stated goals and measurable performance standards.
- (.06) All mitigation plans shall contain a monitoring and maintenance plan to be conducted for a period of five years following mitigation implementation. The applicant shall be responsible for ongoing maintenance and management activities and shall submit an annual report to the Planning Director documenting such activities, and reporting progress towards the mitigation goals. The report shall contain, at a minimum, photographs from established photo points, quantitative measure of success criteria, including plant survival and vigor if these are appropriate data. The Year 1 annual report shall be submitted one year following mitigation action implementation. The final annual report (Year 5 report) shall document successful satisfaction of mitigation goals, as per the stated performance standards. If the ownership of the mitigation site property changes, the new owners will have the continued responsibilities established by this section.
- (.07) The Mitigation Plan document shall be prepared by a natural resource professional.
- (.08) Prior to any site clearing, grading or construction, the SROZ area shall be staked, and fenced per approved plan. During construction, the SROZ area shall remain fenced and undisturbed except as allowed by an approved development permit.
- (.09) For any development which creates multiple parcels intended for separate ownership, the City shall require that the SROZ areas on the site be encumbered with a conservation easement or tract.
- (.10) The City may require a conservation easement over the SROZ that would prevent the owner from activities and uses inconsistent with the purpose of this Section and any easements therein. The purpose of the conservation easement is to conserve and protect resources as well as to prohibit certain activities that are inconsistent with the purposes of this section. Such conservation easements do not exclude the installation of utilities.
- (.11) At the Planning Directors discretion, mitigation requirements may be modified based on minimization of impacts at the impact activity site. Where such modifications are granted by the Planning Director, the Director shall clearly indicate the reasons for doing so in the record, citing the relevant information relied upon in reaching the decision.

**(.12) The Director may study the possibility of a payment-in-lieu-of system for natural resource impact mitigation. This process would involve the public acquisition and management of natural resource properties partially funded by these payments.**

**Table NR – 4**  
*Natural Resource Enhancement Mitigation Ratios*

Existing Function* Rating at Impact Site	Existing Function* Rating at Mitigation Site	Proposed Function* Rating at Mitigation Site	Area Ratio (Mitigation: Impact)
L	L	M	2:1
L	L	H	1 ½ : 1
<b>L</b>	<b>M</b>	<b>H</b>	<b>2 : 1</b>
M	L	M	3 : 1
M	L	H	2 : 1
M	M	H	2 ½ : 1
H	L	M	4 : 1
H	L	H	3 : 1
H	M	H	2 ½ : 1
H	H	H+	5 : 1

\* mitigation function (i.e. water quality, ecological integrity) shall be the same as impacted function + improve on a H rating

NOTE: These mitigation ratios were created by specifically for the Natural Resources Plan by Fishman Environmental Services.

**Applicant’s Response: As previously mentioned, the Owner/Application is proposing to fill a small non-jurisdictional wetland (man-made drainage) consisting of approximately 412 square feet. Given its isolated location and condition, this feature is assumed to have a low functional rating.**

**Based on the low functional rating, the 412 square feet is required to be mitigated at 2:1 ratio.**

**In order to mitigate for the loss of one (1) small wetland area, the City’s staff recommended enhancing the buffer area along the seasonal drainage corridor located along the eastern boundary of the property. The Owner/Applicant is proposing to enhance approximately 20,013 square feet which exceeds the minimum requirement of 824 square feet. This area will be enhanced with 25 trees and be hydroseeded with a native plant seed mixt to supplement the existing vegetation.**

**Refer to Section D – Appendices, Appendix 13 - Significant Resource Impact Report (SRIR) for further information.**

**Section 4.139.08 Activities Requiring a Class I Administrative Review Process** *This criterion is not applicable to this application since the Significant Resource Overlay Zone Map Verification will be reviewed through a Class II Administrative Review Process.*

**Section 4.139.09 Activities Requiring a Class II Administrative Review Process**

- (.01) The review of any action requiring an SRIR except:
- A. Activities and uses exempt under this Section;
  - B. Adjustments permitted as a Class I Administrative Review.
  - C. Adjustments permitted as part of a Development Review Board public hearing process.

***Applicant's Response:*** *Typically, the proposed Significant Resource Impact Report (SRIR) will be reviewed through a Class II administrative review process. However, since this is being review in conjunction with Type III applications, the Development Review Board will also consider this application.*

- (.02) Single family dwelling or the expansion of a single family dwelling on lots with limited buildable land. Single family dwelling or the expansion of a single family dwelling which meet all of the following requirements:

***Applicant's Response:*** *The proposed improvements do not contain any single-family dwelling or consist of any expansions on single-family lots.*

- (.03) The expansion of an existing single family dwelling or structures that are accessory to a single-family dwelling located inside Metro's UGMFP Title 3 Water Quality Resource Areas.

***Applicant's Response:*** *The proposed improvements do not any structures that are accessory to single-family dwellings.*

**Section 4.139.10 Development Review Board (DRB) Process**

The following actions require review through a Development Review Board quasi-judicial process. Nothing contained herein shall be deemed to require a hearing body to approve a request for a permit under this Section.

- (.01) Exceptions. The following exceptions may be authorized through a Development Review Board quasi-judicial review procedure.
- A. Unbuildable Lot. For existing non-developed lots that are demonstrated to be unbuildable by the provisions of this Section, the SROZ shall be reduced or removed to assure the lot will be buildable by allowing up to 3,000 square feet of land to be developed by impervious improvements for residential use, or 5,000 square feet of impervious improvements for non-residential uses, while still providing for the



maximum protection of the significant resources, if not in conflict with any other requirements of the Planning and Land Development Ordinance. This section shall not apply to lots created after the effective date of this ordinance.

- B. Large Lot Exception. An exception under this paragraph is authorized and may allow impact into wetlands, riparian corridors and wildlife habitat areas, and shall not be limited to locations solely within the Area of Limited Conflicting Use. Mitigation is required, and for wetland impacts, state and federal permit requirements shall be followed. An exception to the standards of this Section may be authorized where the following conditions apply:
1. The lot is greater than one acre in size; and
  2. At least 85 percent of the lot is located within the SROZ based on surveyed resource and property line boundaries; and
  3. No more than 10 percent of the area located within the SROZ on the property may be excepted and used for development purposes; and
  4. Through the review of an SRIR, it is determined that a reduction of the SROZ does not reduce the values listed on the City of Wilsonville Natural Resource Function Rating Matrix for the resource site; and
  5. The proposal is sited in a location that avoids or minimizes impacts to the significant resource to the greatest extent possible.
  6. For purposes of this subsection, "lot" refers to an existing legally created lot of record as of the date of the adoption of the SROZ.
- C. Public. If the application of this Section would prohibit a development proposal by a public agency or public utility, the agency or utility may apply for an exception pursuant to this Section. The hearing body shall use the SRIR review criteria identified within this section.
- D. Map Refinement process. The applicant may propose to amend the SROZ boundary through a Development Review Board quasi-judicial zone change where more detailed information is provided, such as a state approved wetland delineation. The criteria for amending the SROZ are as follows:
1. Any map refinement must be evaluated by considering the riparian corridor types contained in this ordinance.
  2. Other supporting documents to be considered in evaluating a proposal to refine a map include, but are not limited to:
    - a. Natural Resources Inventories (LWI/RCI);
    - b. The Economic, Social, Environmental and Energy (ESEE) Analysis;

- c. Metro Functional Plans;
  - d. Wilsonville Comprehensive Plan;
  - e. State approved wetland delineations;
  - f. Detailed slope analysis
3. An SRIR must be prepared by the applicant in conformance with the provisions of this Section.
  4. The Hearing Body (including City Council) may amend the Significant Resource Overlay Zone (in or out) upon making a determination that the land area in question is or is not a significant resource. The criteria for determining that land is significant shall be based on finding that the site area has at least one rating of “high” using the function criteria listed in the Natural Resource Function Rating Matrices.

**Applicant’s Response: *The Owner/Applicant understand that the Development Review Board may authorize exceptions based on certain situations listed above.***

***Through the SRIR report, the Owner/Applicant has provided more detailed information on the location and characteristics of the resource area.***

***The Corp of Engineers has determined that the man-made drainage swale is not waters of the U.S. Similarly, the Oregon Department of State Lands will not be involved in the filling of the man-made drainage swale because the wetland requires less than 50 cubic yards of fill. Therefore, the City is the only agency that maintains jurisdiction over the man-made drainage swale.***

***Refer to Section D – Appendices, Appendix 12 – Wetland Delineation Report, Appendix 13 - Significant Resource Impact Report (SRIR), Appendix 14, Joint Cut/Fill Permit and Appendix 15 – Approved Jurisdictional Determination..***

- (.02) Adding Wetlands. Except for water quality or storm water detention facilities, the City shall initiate amendments to the Significant Resource Overlay Zone maps to add wetlands when the City receives significant evidence that a wetland meets any one of the following criteria:
- A. The wetland is fed by surface flows, sheet flows or precipitation, and has evidence of flooding during the growing season, and has 60 percent or greater vegetated cover, and is over one-half acre in size; or the wetland qualifies as having intact water quality function under the 1996 Oregon Freshwater Wetland Assessment Methodology; or
  - B. The wetland is in the Metro Title 3 Flood Management Area as corrected by the most current FEMA Flood Insurance Rate Maps, and has evidence of flooding during the

growing season, and is five acres or more in size, and has a restricted outlet or no outlet; or the wetland qualifies as having intact hydrologic control function under the 1996 Oregon Freshwater Wetland Assessment Methodology; or

- C. The wetland or a portion of the wetland is within a horizontal distance of less than one-fourth mile from a water body which meets the Department of Environmental Quality definition of water quality limited water body in OAR Chapter 340, Division 41 (1996).
- D. Created or restored wetlands that meet the requirements of Section 4.139.10(.02) shall be added to the Significant Resource Overlay Zone. *[Added by Ord. # 674 11/16/09]*

**Applicant's Response:** *The Owner/Applicant acknowledges that the City is required to initiate amendments to the Significant Resource Overlay Zone maps to add wetlands when the City receives significant evidence that a wetland exists.*

*While the subject property contains a number of resources, the generalized locations of these have already been included in the City Significant Resource Overlay Zone map. As part of the Significant Resource Impact Report (SRIR), the boundary of a portion of the subject property has been delineated and will be updated.*

- (.03) Development of structures, additions and improvements that relate to uses other than single family residential.

**Applicant's Response:** *The Owner/Applicant is proposing to improve the internal circulation, building access and surface parking configuration. As part of effort, one small area within the Significant Resource Overlay Zone will be impacted by the proposed modifications. In accordance with this section of the code, uses other than single-family residential, are required to be reviewed by the Development Review Board.*

- (.04) Variances. A variance may be taken to any of the provisions of this Section per the standards of Section 4.196 of the Planning and Land Development Ordinance.

**Applicant's Response:** *No variances are being requested as part of the proposed improvements to the circulation and surface parking.*

**Section 4.139.11 Special Provisions** *This criterion is not applicable to this application since no reductions to the setbacks are being requested and no density transfers are being proposed.*

- (.03) Alteration of constructed drainageways. Alteration of constructed drainageways may be allowed provided that such alterations do not adversely impact stream flows, flood storage capacity and in stream water quality and provide more efficient use of the land as well as provide improved habitat value through mitigation, enhancement and/or restoration. Such alterations must be evaluated through an SRIR and approved by the City Engineer and Development Review Board.

**Applicant's Response: The proposed improvements do not include the alteration of constructed drainageways.**

## General Development Regulations and Standards

### On-site Pedestrian Access and Circulation

**Section Contains:**

- **Section 4.154. On-site Pedestrian Access and Circulation**

**Section 4.154. On-site Pedestrian Access and Circulation.**

(.01) On-site Pedestrian Access and Circulation

- A. The purpose of this section is to implement the pedestrian access and connectivity policies of the Transportation System Plan. It is intended to provide for safe, reasonably direct, and convenient pedestrian access and circulation.**

***Applicant's Response:*** *The Owner/Applicant understand that the purpose of the implementing pedestrian access and connectivity policies is to provide for safe, reasonably direct and convenient access and circulation.*

B. Standards. Development shall conform to all of the following standards:

- 1. Continuous Pathway System. A pedestrian pathway system shall extend throughout the development site and connect to adjacent sidewalks, and to all future phases of the development, as applicable.**

***Applicant's Response:*** *The Parkway Woods Business Park currently contains a pedestrian pathways that extends the full length of the developed portion of property in both directions. Along SW Parkway Avenue, there is a meandering sidewalk that parallels the roadway, maintaining both vertical and horizontal separation from the roadway. Similarly, on the south side of the building, there is a pedestrian pathway that continues in an east-west direction from SW Parkway Avenue to the edge of the property on the east.*

*The proposed development intends on reconfiguring the existing parking areas along the north, west and south sides as well as developing additional parking areas/vehicular circulation on the south and east side of the building. As part of this redevelopment, a continuous pedestrian pathway/walkways will be added to promote internal circulation along the building and through the site including the surface parking areas.*

*Along the south side of the property, a continuous walkway extends from SW Parkway Avenue through the parking areas to a point along the southeast corner of the building. From there, it connects with an existing walkway the extend to the edge of the property.*

*Because the shipping and receiving components are located along the north side of the building, a majority the pedestrian connectivity occurs in a north-south orientation. These areas terminate at the future right-of-way of SW Printer Parkway which will eventually contain a future multi-use pathway and serve as primary east-west route on the north side of the property.*

- 2. Safe, Direct, and Convenient. Pathways within developments shall provide safe, reasonably direct, and convenient connections between primary building entrances and all adjacent parking areas, recreational areas/playgrounds, and public rights-of-way and crosswalks** based on all of the following criteria:
  - a. Pedestrian pathways are designed primarily for pedestrian safety and convenience, meaning they are free from hazards and provide a reasonably smooth and consistent surface.
  - b. The pathway is reasonably direct. A pathway is reasonably direct when it follows a route between destinations that does not involve a significant amount of unnecessary out-of-direction travel.
  - c. The pathway connects to all primary building entrances and is consistent with the Americans with Disabilities Act (ADA) requirements.
  - d. All parking lots larger than three acres in size shall provide an internal bicycle and pedestrian pathway pursuant to Section 4.155(.03)(B.)(3.)(d.).

***Applicant's Response:*** *As part of the redevelopment and reconfiguration of the parking areas, new accessible routes will directly connect the primary and secondary entrances, the accessible parking areas and the existing right-of-way along SW Parkway Avenue and the future right-of way along SW Printer Parkway. Numerous connections through the parking areas provide safe and convenient connections to the existing building as well as around the perimeter of the building.*

- 3. Vehicle/Pathway Separation. Except as required for crosswalks, per subsection 4, below, where a pathway abuts a driveway or street it shall be vertically or horizontally separated from the vehicular lane.** For example, a pathway may be vertically raised six inches above the abutting travel lane, or horizontally separated by a row of bollards.

***Applicant's Response:*** *All of the proposed sidewalks will be vertically separated from vehicular drives and access ways by a six inch (6") curb.*

- 4. Crosswalks. Where a pathway crosses a parking area or driveway, it shall be clearly marked with contrasting paint or paving materials** (e.g., pavers, light-color concrete inlay between asphalt, or similar contrast).

**Applicant's Response:** *All pathways that cross parking areas or driveways will be clearly marked and constructed of concrete that is inlaid between the asphalt paving. This will provide a visual separation identifying pedestrian crossings.*

5. Pathway Width and Surface. Primary pathways shall be constructed of concrete, asphalt, brick/masonry pavers, or other durable surface, and not less than five (5) feet wide. Secondary pathways and pedestrian trails may have an alternative surface except as otherwise required by the ADA.

**Applicant's Response:** *All primary sidewalks and pathways will be constructed out of concrete and meet the minimum width of five (5) feet. Secondary sidewalks and/or pathways may be constructed of asphalt paving.*

6. All pathways shall be clearly marked with appropriate standard signs. *[Added by Ord. #719, 6/17/13]*

**Applicant's Response:** *All pathways will be clearly marked and be marked in accordance with the Owner/Applicant Sign Master Plan requirements meeting the wayfinding standards.*

## Parking, Loading, and Bicycle Parking

### Section Contains:

- Section 4.155. General Regulations - Parking, Loading and Bicycle Parking

### Section 4.155. General Regulations - Parking, Loading and Bicycle Parking.

#### (.01) Purpose:

- A. The design of parking areas is intended to enhance the use of the parking area as it relates to the site development as a whole, while providing efficient parking, vehicle circulation and attractive, safe pedestrian access.**
- B. As much as possible, site design of impervious surface parking and loading areas shall address the environmental impacts of air and water pollution, as well as climate change from heat islands.**
- C. The view from the public right of way and adjoining properties is critical to meet the aesthetic concerns of the community and to ensure that private property rights are met. Where developments are located in key locations such as near or adjacent to the I-5 interchanges, or involve large expanses of asphalt, they deserve community concern and attention.**

***Applicant's Response: The Owner/Applicant acknowledge the purpose of the Parking, Loading and Bicycle Parking regulations is to use site design to enhance the use of the parking area, while providing efficient parking, vehicle circulation and attractive, safe pedestrian access.***

#### (.02) General Provisions:

- A. The provision and maintenance of off-street parking spaces is a continuing obligation of the property owner. The standards set forth herein shall be considered by the Development Review Board as minimum criteria.
  1. The Board shall have the authority to grant variances or planned development waivers to these standards in keeping with the purposes and objectives set forth in the Comprehensive Plan and this Code.
  2. Waivers to the parking, loading, or bicycle parking standards shall only be issued upon a finding that the resulting development will have no significant adverse impact on the surrounding neighborhood, and the community, and that the development considered as a whole meets the purposes of this section.

***Applicant's Response: In accordance with this section, it understood that the provision and maintenance of any off-street parking spaces will be the continuing obligation of the property owner, which in this case will be PWII Owner, LLC.***



- B. No area shall be considered a parking space unless it can be shown that the area is accessible and usable for that purpose, and has maneuvering area for the vehicles, as determined by the Planning Director.

**Applicant's Response:** *All proposed parking areas will be useable unless otherwise restricted/reserved for accessibility, service and/or management. This will include standard, compact, accessible, carpool/vanpool and EV stalls.*

- C. In cases of enlargement of a building or a change of use from that existing on the effective date of this Code, the number of parking spaces required shall be based on the additional floor area of the enlarged or additional building, or changed use, as set forth in this Section. Current development standards, including parking area landscaping and screening, shall apply only to the additional approved parking area.

**Applicant's Response:** *Each of the new parking areas proposed by the Applicant/Owner will include stalls and landscape island/planters and will be designed to meet the standards that are currently in effect including parking area landscaping.*

- D. In the event several uses occupy a single structure or parcel of land, the total requirement for off-street parking shall be the sum of the requirements of the several uses computed separately, except as modified by subsection "E," below.

**Applicant's Response:** *In accordance with this section, the Owner/Applicant acknowledges that when several uses occupy a single structure or parcel of land, that the total requirement for off-street parking will be the sum of the requirements of the several uses computed separately.*

*For the Parkway Woods Business Park, the parking requirements for user/tenant will be calculated on an individual basis to ensure compliance with the minimum/maximum parking requirements.*

- E. Owners of two (2) or more uses, structures, or parcels of land may utilize jointly the same parking area when the peak hours of operation do not overlap, provided satisfactory legal evidence is presented in the form of deeds, leases, or contracts securing full and permanent access to such parking areas for all the parties jointly using them. *[Amended by Ord. # 674 11/16/09]*

**Applicant's Response:** *Given that the existing development is only partially leased, it is difficult to determine whether or not the peak hours of operation will overlap. However, for purposes of this application, it is assumed that the peak hours of operation for all of the users will occur during the typical daytime business hours (i.e. 7:00a to 7:00p).*

*Based on the peak operating hours and the fact that each tenant has their own lease stipulating the minimum parking ratios, it is unlikely that any joint use of parking will occur. Therefore, compliance with*

***the overall minimum and maximum parking ratios will be computed on an aggregate amount from all of the existing and proposed uses.***

- F. Off-street parking spaces existing prior to the effective date of this Code may be included in the amount necessary to meet the requirements in case of subsequent enlargement of the building or use to which such spaces are necessary.

**Applicant's Response: *The Owner/Applicant understands that any off-street parking that existed prior to the effective date of this Code can be included in the amount necessary to meet the requirements.***

***Based on the proposed improvements, very few of existing spaces will remain unaffected by the proposed modification and reconfiguration of the circulation and surface parking areas. Taking into consideration the proposed changes, the new circulation and surface parking areas will accommodate a total of 1,221 spaces. Overall, there will be no net change in the number of permanent surface parking spaces.***

***In addition, there is a small remnant asphalt area that will be utilized for staging in the short term and ultimately be developed as a future building pad. Depending upon phasing, this area could provide a nominal amount of parking (temporary) in the short term.***

***For additional information, refer to Section C – Exhibit Drawings, Sheet 04 – Site Plan – Overall (Preliminary) for compliance with these requirements.***

- G. Off-Site Parking. Except for single-family dwellings, the vehicle parking spaces required by this Chapter may be located on another parcel of land, provided the parcel is within 500 feet of the use it serves and the DRB has approved the off-site parking through the Land Use Review. The distance from the parking area to the use shall be measured from the nearest parking space to the main building entrance, following a sidewalk or other pedestrian route. The right to use the off-site parking must be evidenced in the form of recorded deeds, easements, leases, or contracts securing full and permanent access to such parking areas for all the parties jointly using them. *[Amended by Ord. # 674 11/16/09]*

**Applicant's Response: *All required parking for the users/tenants of the Parkway Woods Business Park will be located on-site and within close proximity of the use it is intended to serve.***

***One of the purposes of modifying the existing circulation and surfacing parking was is to provide more convenient and accessible parking locations for existing and future users/tenants of the building. Currently, a majority of the existing parking is primarily located on the north side of the building which does not allow for convenient and accessible parking in close proximity to leasable space along the south side of the building.***

*To address this, new spaces are being added to the south and east side of the building to provide a greater distribution of stalls in close proximity (within 500 feet) of the tenant spaces.*

*For additional information, refer to Section C – Exhibit Drawings, Sheet 04 – Site Plan -Overall (Preliminary) for compliance with these requirements.*

- H. The conducting of any business activity shall not be permitted on the required parking spaces, unless a temporary use permit is approved pursuant to Section 4.163.

***Applicant's Response: All of the business activity will be contained wholly within the portion of the building that is legally controlled and identified within each lease agreement. None of the individual business activities will be allowed to take place within required parking spaces without a temporary use permit.***

- I. Where the boundary of a parking lot adjoins or is within a residential district, such parking lot shall be screened by a sight-obscuring fence or planting. The screening shall be continuous along that boundary and shall be at least six (6) feet in height.

***Applicant's Response: None of the existing or proposed parking areas adjoin or are located within a residential district.***

- J. Parking spaces along the boundaries of a parking lot shall be provided with a sturdy bumper guard or curb at least six (6) inches high and located far enough within the boundary to prevent any portion of a car within the lot from extending over the property line or interfering with required screening or sidewalks.

***Applicant's Response: All of the spaces along the periphery within the modified and/or reconfigured surface parking areas will contain six (6) inch curbs that will prevent a car within the lot from extending over the property line or interfering with required screening or sidewalks.***

- K. All areas used for parking and maneuvering of cars shall be surfaced with asphalt, concrete, or other surface, such as pervious materials (i. e. pavers, concrete, asphalt) that is found by the City's authorized representative to be suitable for the purpose. In all cases, suitable drainage, meeting standards set by the City's authorized representative, shall be provided. [Amended by Ord. # 674 11/16/09]

***Applicant's Response: The areas used for surface parking and vehicular maneuvering will be surfaced with asphaltic concrete paving. In some instances, where truck and vehicular traffic share common areas, a more durable surface consisting of solely of concrete surfacing will be used.***

- L. Artificial lighting which may be provided shall be so limited or deflected as not to shine into adjoining structures or into the eyes of passers-by.

**Applicant's Response:** *Artificial lighting from parking lot illumination will be shielded in order to prevent direct light and glare on adjacent structures and passers-by.*

*Within the subject property, exterior lighting (parking lot and lighting along the building facades) will be appropriately located to maintain consistent lighting level in order to promote public safety and security. Based on the photometric analysis, the illumination levels at the property line is less than 0.2 foot-candles.*

*Refer to Section C – Exhibit Drawings, Sheet 27 – Site Lighting Plan – Overall (Preliminary) for further information.*

- M. Off-street parking requirements for types of uses and structures not specifically listed in this Code shall be determined by the Development Review Board if an application is pending before the Board. Otherwise, the requirements shall be specified by the Planning Director, based upon consideration of comparable uses.

**Applicant's Response:** *The Owner/Applicant acknowledge that for any types of uses and/or structures not specifically listed in this Code, the Development Review Board will determine the off-street parking requirements.*

*Again, since the occupants of several of the lease spaces have yet to be determined, it assumed that each of the proposed uses as well as any future uses will be uses will be permitted outright with the Planned Development Industrial (PDI) district and that the parking requirements of these uses can be accommodated on site.*

- N. Up to forty percent (40%) of the off-street spaces may be compact car spaces as identified in Section 4.001 - "Definitions," and shall be appropriately identified.

**Applicant's Response:** *The proposed site plan identifies 1,221 stalls. In accordance with this section, up to forty percent (40%) of the off-street subject property spaces may be compact stalls. Based on 1,221 total stalls, up to 488 spaces could be designed as compact stalls. The proposed site plan identifies seven (7) stalls that have been designed as compact spaces (measuring 9 feet wide by 15 feet in length). All of the new expanded and/or reconfigured spaces will meet the City's standard stall dimensions (measuring 9 feet wide by 18 feet in length).*

- O. Where off-street parking areas are designed for motor vehicles to overhang beyond curbs, planting areas adjacent to said curbs shall be increased to a minimum of seven (7) feet in depth. This standard shall apply to a double row of parking, the net effect of which shall be to create a planted area that is a minimum of seven (7) feet in depth.

**Applicant's Response:** *All of the new expanded and/or reconfigured spaces will meet or exceed the City's minimum standard stall dimensions: nine (9) feet wide and eighteen (18) feet long for standard stalls and seven (7) feet,*

*six (6) inches wide and fifteen (15) feet long for compact stalls. As a practical point, all of the stalls have been designed with a width of nine (9) feet and only the length varies between the compact and standard stalls. None of the spaces will be designed for motor vehicles to overhang beyond curbs.*

(.03) Minimum and Maximum Off-Street Parking Requirements:

- A. Parking and loading or delivery areas shall be designed with access and maneuvering area adequate to serve the functional needs of the site and shall:
1. Separate loading and delivery areas and circulation from customer and/or employee parking and pedestrian areas. Circulation patterns shall be clearly marked.
  2. To the greatest extent possible, separate vehicle and pedestrian traffic.

***Applicant's Response:*** *Parking and loading areas have been designed to provide sufficient access and maneuvering to each of leasable areas. Additional loading areas have been proposed along the southwest and northwest portions of the building to improve loading and servicing requirements. Each loading area maintains a 30 foot by 60 foot clear area in order to allow shipping and receiving.*

- B. Parking and loading or delivery areas shall be landscaped to minimize the visual dominance of the parking or loading area, as follows:
1. **Landscaping of at least ten percent (10%) of the parking area designed to be screened from view from the public right-of-way and adjacent properties. This landscaping shall be considered to be part of the fifteen percent (15%) total landscaping required in Section 4.176.03 for the site development.**
  2. Landscape tree planting areas shall be a minimum of eight (8) feet in width and length and spaced every eight (8) parking spaces or an equivalent aggregated amount.
    - a. Trees shall be planted in a ratio of one (1) tree per eight (8) parking spaces or fraction thereof, except in parking areas of more than two hundred (200) spaces where a ratio of one (1) tree per six (six) spaces shall be applied as noted in subsection (.03)(B.)(3.). A landscape design that includes trees planted in areas based on an aggregated number of parking spaces must provide all area calculations.
    - b. Except for trees planted for screening, all deciduous interior parking lot trees must be suitably sized, located, and maintained to provide a branching minimum of seven (7) feet clearance at maturity.
  3. **Due to their large amount of impervious surface, new development with parking areas of more than two hundred (200) spaces that are located in any zone, and**

that may be viewed from the public right of way, shall be landscaped to the following additional standards:

- a. **One (1) trees shall be planted per six (6) parking spaces or fraction thereof. At least twenty-five percent (25%) of the required trees must be planted in the interior of the parking area.**
- b. **Required trees may be planted within the parking area or the perimeter, provided that a minimum of forty percent (40%) of the canopy dripline of mature perimeter trees can be expected to shade or overlap the parking area.** Shading shall be determined based on shadows cast on the summer solstice.
- c. **All parking lots in excess of two hundred (200) parking spaces shall provide an internal pedestrian walkway for every six (6) parking aisles. Minimum walkway clearance shall be at least five (5) feet in width.** Walkways shall be designed to provide pedestrian access to parking areas in order to minimize pedestrian travel among vehicles. Walkways shall be designed to channel pedestrians to the front entrance of the building.
- d. **Parking lots more than three acres in size shall provide street-like features along principal drive isles, including curbs, sidewalks, street trees or planting strips, and bicycle routes.**
- e. **All parking lots viewed from the public right of way shall have a minimum twelve (12) foot landscaped buffer extending from the edge of the property line at the right of way to the edge of the parking area.** Buffer landscaping shall meet the low screen standard of 4.176(.02)(D) except that trees, groundcovers and shrubs shall be grouped to provide visual interest and to create view openings no more than ten (10) feet in length and provided every forty (40) feet. Notwithstanding this requirement, view of parking area that is unscreened from the right of way due to slope or topography shall require an increased landscaping standard under 4.176(.02) in order to buffer and soften the view of vehicles as much as possible. For purposes of this section, "view from the public right of way" is intended to mean the view from the sidewalk directly across the street from the site, or if no sidewalk, from the opposite side of the adjacent street or road.
- f. Where topography and slope condition permit, the landscape buffer shall integrate parking lot storm water treatment in bioswales and related plantings. Use of berms or drainage swales are allowed provided that planting areas with lower grade are constructed so that they are protected from vehicle maneuvers. Drainage swales shall be constructed to Public Works Standards.
- g. In addition to the application requirements of section 4.035(.04)(6)(d), where view of signs is pertinent to landscape design, any approved or planned sign plan shall accompany the application for landscape design approval.

*[Amended by Ord. #719, 6/17/13]*

**Applicant's Response:** *As required by the City code, at least ten percent (10%) of the parking area is required to be landscaped. This landscaping can be considered to be part of the fifteen percent (15%) total landscaping required and 10% of the Parking Area is required to be landscaped.*

*Excluding the open space enhancement area, the actual amount of native planting and landscaping represents 838,502 SF (19.25 Ac.) or 22.8% of the net site area. Within the parking area, there is 487,175 square feet. Based on the landscape plan, 127,370 SF or 26.1% within the parking area is landscaped. These numbers exceed the minimum City requirements.*

*Code requires planters are spaced at intervals averaging 1 planter for every six stalls. Based on 1,221 stalls, a total of 204 landscape trees (calculated by dividing 1,221 stalls by one per 6 spaces) are required within and around the perimeter of the parking area. A minimum of twenty five percent (25%) of these or 51 trees are required to be within the interior of the parking area.*

*In an effort to preserve existing trees, the Owner/Applicant developed an alternative landscape plan that meets the aggregated amount of planters/trees, but the spacing may vary depending upon individual tree locations and their associates roots zones. The spacing generally reflects 1 planter for every six stalls, except where existing trees are being preserved. In these situations, the planters are aggregated to minimize the impact within the root zones of the trees being protected. This creates situations where trees/planter strips are spaced further apart.*

*The required number of required trees could be reduced by 90 based on tree credits allowed for preserving existing trees. However, in order to meet the tree canopy coverage requirement, the actual number of parking lot trees could not be reduced.*

*The proposed landscape plan identified the planting of 462 trees. Two hundred ninety seven (297) of these will be located within and around the perimeter of the parking areas, which exceeds the minimum of 204 trees. Of the 297 proposed trees, 244 trees comply with the minimum planting areas of eight (8) feet in width and length. The planter islands size for the remaining 53 trees are less in order to accommodate internal walkways. Each planter island will contain trees, shrubs and ground covers.*

*The parking area contains 487,175 square feet. Based on the Tree Canopy Coverage Plan (Drawing Exhibit 26), 196,846 square feet or 40.4% will maintain canopy coverage at a 15 year maturity. Where*

*applicable, internal walkways will be provided and meet the minimum with requirements.*

*Because the parking areas exceed two hundred (200) parking spaces, internal pedestrian walkway for every six (6) parking aisles. Minimum walkway clearance shall be at least five (5) feet in width. While the proposed design does not have more than six (6) drive aisles in any location, it does provide internal walkways located perpendicular to the drive aisles. These are uniformly distributed throughout the reconfigures and expanded parking areas.*

*Since the parking areas exceed three (3) acres in size, street-like features are required along principal drive aisles. The proposed provide curbs, sidewalks, street trees or planting strips along the major internal routes through the parking areas.*

*Refer to Section C – Exhibit Drawings, Exhibit 16 – Landscape Plan - Overall (Preliminary), Exhibit 17 – Landscape Plan - Northwest Quadrant (Preliminary), Exhibit 18 – Landscape Plan - Northeast Quadrant (Preliminary), Exhibit 19 – Landscape Plan - Southwest Quadrant (Preliminary) and Exhibit 20 – Landscape Plans - Southeast Quadrant (Preliminary) for additional information.*

- C. **Off Street Parking shall be designed for safe and convenient access that meets ADA and ODOT standards. All parking areas which contain ten (10) or more parking spaces, shall for every fifty (50) standard spaces, provide one ADA-accessible parking space that is constructed to building code standards, Wilsonville Code 9.000.**

***Applicant's Response:*** *Since the new parking areas exceed more than two hundred (200) spaces, a sufficient amount of ADA accessible parking is required. Based on 1,221 spaces, a total of 25 ADA spaces are required.*

*Based on the proposed site plan, there are 25 accessible spaces that are dispersed throughout the site. These are located in groupings of 2-4 spaces near the primary and secondary entrances.*

- D. Where possible, parking areas shall be designed to connect with parking areas on adjacent sites so as to eliminate the necessity for any mode of travel of utilizing the public street for multiple accesses or cross movements. In addition, on-site parking shall be designed for efficient on-site circulation and parking.

***Applicant's Response:*** *There is no parking on adjacent lots that connect directly with the proposed parking facilities on the subject property*

- E. In all multi-family dwelling developments, there shall be sufficient areas established to provide for parking and storage of motorcycles, mopeds and bicycles. Such areas shall be clearly defined and reserved for the exclusive use of these vehicles.



**Applicant's Response: The development does not include any multi-family uses.**

- F. On-street parking spaces, directly adjoining the frontage of and on the same side of the street as the subject property, may be counted towards meeting the minimum off-street parking standards.

**Applicant's Response: There are no on-street parking spaces directly abutting the subject property.**

- G. **Tables 5 shall be used to determine the minimum and maximum parking standards for various land uses.** The minimum number of required parking spaces shown on Tables 5 shall be determined by rounding to the nearest whole parking space. For example, a use containing 500 square feet, in an area where the standard is one space for each 400 square feet of floor area, is required to provide one off-street parking space. If the same use contained more than 600 square feet, a second parking space would be required. Structured parking and on-street parking are exempted from the parking maximums in Table 5.

[Amended by Ordinance No. 538, 2/21/02.]

**Table 5**  
Parking Standards

Use	Parking Minimums	Parking Maximums	Bicycle Minimums
<b>e. Commercial</b>			
1. Retail store except supermarkets and stores selling bulky merchandise and grocery stores 1500 sq. ft. gross floor area or less	4.1 per 1000 sq. ft.	6.2 per 1000 sq. ft.	1 per 4000 sq. ft. Min. of 2
2. Commercial retail, 1501 sq. ft. or more	4.1 per 1000 sq. ft.	6.2 per 1000 sq. ft.	1 per 4000 sq. ft. Min. of 2
3. Service or repair shops	4.1 per 1000 sq. ft.	6.2 per 1000 sq. ft.	1 per 4000 sq. ft.
4. Retail stores and outlets selling furniture, automobiles or other bulky merchandise where the operator can show the bulky merchandise occupies the major areas of the building	1.67 per 1000 sq. ft.	6.2 per 1000 sq. ft.	1 per 8000 sq. ft. Min. of 2
<b>5. Office or flex space (except medical and dental)</b>	<b>2.7 per 1000 sq. ft.</b>	<b>4.1 per 1000 sq. ft.</b>	<b>1 per 5000 sq. ft Min. of 2</b>
<b>f. Industrial</b>			
1. Manufacturing establishment	1.6 per 1000 sq. ft.	No Limit	1 per 10,000 sq. ft. Min. of 6

Use	Parking Minimums	Parking Maximums	Bicycle Minimums
2. Storage warehouse, wholesale establishment, rail or trucking freight terminal	0.3 per 1000 sq. ft.	.5 per 1000 sq. ft.	1 per 20,000 sq. ft. Min. of 2

[Table 5 amended by Ordinance No. 538, 2/21/02]

[Table 5 amended by Ordinance No. 548, 10/9/02]

[Table 5 amended by Ordinance No. 719, 6/17/13]

[Table 5 amended by Ordinance No. 825, 10/15/18]

**Applicant's Response:** *The current building contains 387,453 gross square feet. In order to breakdown the minimum and maximum parking, the individual requirements of each user/tenant has been identified. See calculations below:*

**Minimum Vehicle Stalls Required:**

Building Space	Use	Square Footage	Minimum Rate	Minimum Requirement
Space A	Vacant	29,519	2.7 /1,000 SF	80
Space B	Vacant	28,289	2.7 /1,000 SF	76
Space C	Dealer	41,866	2.7 /1,000 SF	113
Space D1/D2	Vacant	32,053	2.7 /1,000 SF	87
Space E	Vacant	75,754	2.7 /1,000 SF	205
Space F	Vacant	25,590	2.7 /1,000 SF	69
Space G	3D Systems	110,718	2.7 /1,000 SF	299
Common/Garden		31,179	0.3 per seat	9
Mechanical/Corridor		12,485		
<b>Total (Based on Net SF)</b>		<b>387,453</b>		<b>938</b>

**Maximum Vehicle Stall Allowed:**

Building Space	Use	Square Footage	Maximum Rate	Maximum Allowed
Space A	Vacant	29,519	4.1 /1,000 SF	121
Space B	Vacant	28,289	4.1 /1,000 SF	116
Space C	Dealer Spike	41,866	4.1 /1,000 SF	172
Space D1/D2	Vacant	32,053	4.1 /1,000 SF	131
Space E	Vacant	75,754	4.1 /1,000 SF	311
Space F	Vacant	25,590	4.1 /1,000 SF	205

Space G	3D Systems	110,718	4.1 /1,000 SF	545
Common/Garden		31,179	0.5 per seat	15
Mechanical/Corridor		12,485		
<b>Total (Based on Net SF)</b>		<b>387,453</b>		<b>1,616</b>

H. Electrical Vehicle Charging Stations:

- Parking spaces designed to accommodate and provide one or more electric vehicle charging stations on site may be counted towards meeting the minimum off-street parking standards.**
- Modification of existing parking spaces to accommodate electric vehicle charging stations on site is allowed outright.

**Applicant's Response: While there is no minimum EV requirement, parking spaces designed to accommodate and provide one or more electric vehicle charging stations on site may be counted towards meeting the minimum off-street parking standards. At the present time, there are no EV parking spaces proposed.**

I. Motorcycle parking:

- Motorcycle parking may substitute for up to 5 spaces or 5 percent of required automobile parking, whichever is less. For every 4 motorcycle parking spaces provided, the automobile parking requirement is reduced by one space.**
- Each motorcycle space must be at least 4 feet wide and 8 feet deep.** Existing parking may be converted to take advantage of this provision. [Amended by Ord. #719, 6/17/13]

**Applicant's Response: Code allows for motorcycle parking to be substituted up to 5 spaces or 5 percent of required automobile parking, whichever is less. For every 4 motorcycle parking spaces provided, the automobile parking requirement is reduced by one space. Based on the proposed site plan, there are no designated motorcycle parking spaces proposed.**

(.04) Bicycle Parking:

A. Required Bicycle Parking - General Provisions.

- The required minimum number of bicycle parking spaces for each use category is shown in Table 5, Parking Standards.**

2. Bicycle parking spaces are not required for accessory buildings. If a primary use is listed in Table 5, bicycle parking is not required for the accessory use.
3. When there are two or more primary uses on a site, the required bicycle parking for the site is the sum of the required bicycle parking for the individual primary uses.
4. Bicycle parking space requirements may be waived by the Development Review Board per Section 4.118(.03)(A.)(9.) and (10.).

**Applicant’s Response:** *As required by this section of the code, bicycle parking will be provided in the necessary quantities and distribution based on the uses/tenants lease area.*

***Bicycle Parking Stalls Required:***

<i>Building Space</i>	<i>Use</i>	<i>Square</i>	<i>Rate</i>	<i>Number</i>
<i>Space A</i>	<i>Vacant</i>	<i>29,519</i>	<i>1 per 5000</i>	<i>6</i>
<i>Space B</i>	<i>Vacant</i>	<i>28,289</i>	<i>1 per 5000</i>	<i>6</i>
<i>Space C</i>	<i>Dealer</i>	<i>41,866</i>	<i>1 per 5000</i>	<i>8</i>
<i>Space D1/D2</i>	<i>Vacant</i>	<i>32,053</i>	<i>1 per 5000</i>	<i>6</i>
<i>Space E</i>	<i>Vacant</i>	<i>75,754</i>	<i>1 per 5000</i>	<i>15</i>
<i>Space F</i>	<i>Vacant</i>	<i>25,590</i>	<i>1 per 5000</i>	<i>5</i>
<i>Space G</i>	<i>3D Systems</i>	<i>110,718</i>	<i>1 per 5000</i>	<i>22</i>
<i>Common/Garden</i>		<i>31,179</i>	<i>1 per 50</i>	<i>4</i>
<i>Mechanical/Corridor</i>		<i>12,486</i>		
<b><i>Total (Based on Net</i></b>				<b><i>72</i></b>

**Applicant’s Response:** *The existing development contains 45 spaces, 42 of which are bike locker enclosures located along the north side of the building. Based on the aggregate leasable space, a total of 72 bicycle parking spaces are required.*

***Based on the proposed site plan, the bicycle parking area are dispersed throughout the site in four locations: one location on the north and three locations on the south.***

- ***North/Northeast: 24 spaces covered***
- ***Southwest: 4 spaces covered; 12 uncovered***
- ***South Central: 4 spaces covered; 12 uncovered***
- ***Southeast: 4 spaces covered; 12 uncovered***

***For additional information, refer to Section C – Exhibit Drawings, Sheet 04 – Site Plan – Overall (Preliminary) for compliance with these requirements.***

B. Standards for Required Bicycle Parking

1. **Each space must be at least 2 feet by 6 feet in area and be accessible without moving another bicycle.**
2. **An aisle at least 5 feet wide shall be maintained behind all required bicycle parking to allow room for bicycle maneuvering. Where the bicycle parking is adjacent to a sidewalk, the maneuvering area may extend into the right-of-way.**
3. When bicycle parking is provided in racks, there must be enough space between the rack and any obstructions to use the space properly.
4. Bicycle lockers or racks, when provided, shall be securely anchored.
5. **Bicycle parking shall be located within 30 feet of the main entrance to the building or inside a building, in a location that is easily accessible for bicycles. For multi-tenant developments, with multiple business entrances, bicycle parking may be distributed on-site among more than one main entrance.**

***Applicant's Response:*** *The bicycle parking will be located within 30 feet of a primary entrance to the building. Because there are multiple tenants, the parking will be distributed amongst all the major entrances. Refer to Section C - Exhibit Drawings, Sheet 04 – Site Plan – Overall (Preliminary) for compliance with these requirements*

***Where applicable, each outdoor bicycle parking stall will be 2 feet wide by 6 feet in length. A minimum of a five (5) foot wide aisle will be maintained behind all required bicycle parking areas to allow room for bicycle maneuvering.***

C. Long-term Bicycle Parking

1. Long-term bicycle parking provides employees, students, residents, commuters, and others who generally stay at a site for several hours a weather-protected place to park bicycles.
2. ***For a proposed multi-family residential, retail, office, or institutional development, or for a park and ride or transit center, where six (6) or more bicycle parking spaces are required pursuant to Table 5, 50% of the bicycle parking shall be developed as long-term, secure spaces. Required long-term bicycle parking shall meet the following standards:***
  - a. ***All required spaces shall meet the standards in subsection (B.) above, and must be covered in one of the following ways: inside buildings, under roof overhangs or permanent awnings, in bicycle lockers, or within or under other structures.***

**b. All spaces must be located in areas that are secure or monitored (e.g., visible to employees, monitored by security guards, or in public view).**

c. Spaces are not subject to the locational criterion of (B.)(5.). [Section 4.155(.04)  
Added by Ord. #719, 6/17/13]

**Applicant's Response: Based on the total gross square feet of 387,453, at 1 space per 5,000 square feet, 77 bicycle stalls are required. However, accessory uses are not required to provide bicycle parking. Therefore the number of spaces is based on the aggregate leasable space. This would require a total of 72 bicycle parking spaces. Half (50%) of these spaces will be considered long term spaces and will consist of bike storage units.**

**As required, 50% of the total (72) or 36 spaces are required to be secured. Based on the proposed site plan, there is a mixture of long term and short terms spaces with 36 spaces being covered. Below is the distribution of the long term spaces.**

- **North/Northeast: 24 spaces covered/secure**
- **Southwest: 4 spaces covered/secure**
- **South Central: 4 spaces covered/secure**
- **Southeast: 4 spaces covered/secure**

**For additional information, refer to Section C – Exhibit Drawings, Sheet 04 – Site Plan - Overall (Preliminary) for compliance with these requirements.**

(.05) Minimum Off-Street Loading Requirements:

**A. Every building that is erected or structurally altered to increase the floor area, and which will require the receipt or distribution of materials or merchandise by truck or similar vehicle, shall provide off-street loading berths on the basis of minimum requirements as follows:**

**1. Commercial, industrial, and public utility uses which have a gross floor area of 5,000 square feet or more, shall provide truck loading or unloading berths in accordance with the following tables:**

<b>Square feet of Floor Area</b>	<b>Number of Berths Required</b>
Less than 5,000	0
<b>5,000 - 30,000</b>	<b>1</b>
<b>30,000 - 100,000</b>	<b>2</b>
100,000 and over	3

2. Restaurants, office buildings, hotels, motels, hospitals and institutions, schools and colleges, public buildings, recreation or entertainment facilities, and any similar use

which has a gross floor area of 30,000 square feet or more, shall provide off-street truck loading or unloading berths in accordance with the following table:

Square feet of Floor Area	Number of Berths Required
Less than 30,000	0
30,000 - 100,000	1
100,000 and over	2

3. **A loading berth shall contain space twelve (12) feet wide, thirty-five (35) feet long, and have a height clearance of fourteen (14) feet.** Where the vehicles generally used for loading and unloading exceed these dimensions, the required length of these berths shall be increased to accommodate the larger vehicles.
4. If loading space has been provided in connection with an existing use or is added to an existing use, the loading space shall not be eliminated if elimination would result in less space than is required to adequately handle the needs of the particular use.
5. Off-street parking areas used to fulfill the requirements of this Ordinance shall not be used for loading and unloading operations except during periods of the day when not required to meet parking needs.

***Applicant's Response:*** *Because the proposed development does not involve the erection of a new building space or the addition of new floor area, no additional off-street loading is not required. However, for convenience purposes, two new loading/unloading area is proposed that will serve the northwest and southwestern corners of the building. All totaled, there are seventeen (17) loading areas identified on the plan. Each loading area has a clear zone that measures 30 feet wide by 60 feet long and is unobstructed by height limitation.*

B Exceptions and Adjustments.

1. The Planning Director or Development Review Board may approve a loading area adjacent to or within a street right-of-way where it finds that loading and unloading operations:
  - a. Are short in duration (*i.e.*, less than one hour);
  - b. Are infrequent (less than three operations daily);
  - c. Do not obstruct traffic during peak traffic hours;
  - d. Do not interfere with emergency response services or bicycle and pedestrian facilities; and
  - e. Are acceptable to the applicable roadway authority.

**Applicant's Response: No exceptions are being requested to reduce or eliminate the number of required loading berths.**

(.06) Carpool and Vanpool Parking Requirements:

**A. Carpool and vanpool parking spaces shall be identified for the following uses:**

- 1. New commercial and industrial developments with seventy-five (75) or more parking spaces,**
2. New institutional or public assembly uses, and
3. Transit park-and-ride facilities with fifty (50) or more parking spaces.

**B. Of the total spaces available for employee, student, and commuter parking, at least five percent, but not fewer than two, shall be designated for exclusive carpool and vanpool parking.**

**C. Carpool and vanpool parking spaces shall be located closer to the main employee, student or commuter entrance than all other parking spaces with the exception of ADA parking spaces.**

**D. Required carpool/vanpool spaces shall be clearly marked "Reserved - Carpool/Vanpool Only."**

**Applicant's Response: The proposed site plan identified a total of 1,221 parking stalls. Since this is not a new development and is supporting an established industrial use that does not currently provide carpool and vanpool parking, none are proposed.**

(.07) Parking Area Redevelopment. The number of parking spaces may be reduced by up to 10% of the minimum required parking spaces for that use when a portion of the existing parking area is modified to accommodate or provide transit-related amenities such as transit stops, pull-outs, shelters, and park and ride stations.

**Applicant's Response: The proposal does not seek a reduction in parking spaces. Furthermore, none of the existing or proposed parking improvements will be modified to accommodate transit-related amenities.**

**However, it is important to note that the City will likely require the development of a transit stop as part of any future public street improvements. This could be triggered as part of a future land division (i.e. subdivision or partition).**

*[Section 4.155 Amended by Ordinance. No. 536, 1/7/02] [Section 4.155 Amended by Ordinance. No. 719, 6/17/13]*



## Signage

### Section Contains:

- Section 4.156.01 – Sign Regulations Purpose and Objectives
- Section 4.156.02 – Sign Review Process and General Requirements
- Section 4.156.03 – Sign Measurement
- Section 4.156.04 – Non-Conforming Signs *(Not Applicable to this Application)*
- Section 4.156.05 – Signs Exempt From Sign Permit Requirements
- Section 4.156.06 – Prohibited Signs
- Section 4.156.07 – Sign Regulations In Residential Zones *(Not Applicable to this Application)*
- Section 4.156.08 – Sign Regulations in the PDC, PDI, and PF Zones
- Section 4.156.09 – Temporary Signs In All Zones
- Section 4.156.10 – Signs on City and ODOT Right-Of-Way
- Section 4.156.11 – Sign Enforcement *(Not Applicable to this Application)*

### Section 4.156.01. Sign Regulations Purpose and Objectives.

- (.01) **Purpose.** The general purpose of the sign regulations are to provide one of the principal means of implementing the Wilsonville Comprehensive Plan by fostering an aesthetically pleasing, functional, and economically vital community, as well as promoting public health, safety, and well-being. The sign regulations strive to accomplish the above general purpose by meeting the needs of sign owners while maintaining consistency with the development and design standards elsewhere in Chapter 4. This code regulates the design, variety, number, size, location, and type of signs, as well as the processes required to permit various types of signs. Sign regulations have one or more of the following specific objectives:
- A. Well-designed and aesthetically pleasing signs sufficiently visible and comprehensible from streets and rights-of-way that abut a site as to aid in wayfinding, identification and provide other needed information.
  - B. Sign design and placement that is compatible with and complementary to the overall design and architecture of a site, along with adjoining properties, surrounding areas, and the zoning district.
  - C. A consistent and streamlined sign review process that maintains the quality of sign development and ensures due process.
  - D. Consistent and equitable application and enforcement of sign regulations.
  - E. All signs are designed, constructed, installed, and maintained so that public safety, particularly traffic safety, are not compromised.
  - F. Sign regulations are content neutral.

**Applicant's Response:** *The Owner/Applicant acknowledges that the general purpose of the sign regulations is to foster an aesthetically pleasing, functional and*

*promotes public safety through wayfinding, identification and other types of information.*

**Section 4.156.02. Sign Review Process and General Requirements.**

- (.01) Permit Required. Unless exempt under Section 4.156.05, no sign, permanent or temporary, shall be displayed or installed in the City without first obtaining a sign permit.

***Applicant's Response: The Owner/Applicant understands that no signage (permanent or temporary), will be displayed or installed in the City without first obtaining a sign permit.***

***Through the submittal and subsequent review/approval of a Master Sign Plan application, the Owner/Applicant be in compliance this requirement. This document will be the basis for approving authority for future individual sign permits.***

- (.02) Sign Permits and Master Sign Plans. Many properties in the City have signs pre-approved through a Master Sign Plan. For the majority of applications where a Master Sign Plan has been approved the applicant need not consult the sign requirements for the zone, but rather the Master Sign Plan, copies of which are available from the Planning Division. Signs conforming to a Master Sign Plan require only a Class I Sign Permit.

***Applicant's Response: In accordance with this section, the Owner/Applicant acknowledges that once the Master Sign Plan has been approved, future applications for signage need only to demonstrate compliance with the Master Plan document through a Class I Sign Permit procedure.***

- (.03) Classes of Sign Permits, Master Sign Plans, and Review Process. The City has three classes of sign permits for permanent signs: Class I, Class II, and Class III. In addition, non-residential developments with three or more tenants require a Master Sign Plan. Class I sign permits are reviewed through the Class I Administrative Review Process as outlined in Subsection 4.030(.01)(A.). Class II sign permits are reviewed through the Class II Administrative Review Process as outlined in Subsection 4.030 (.01)(B.). Class III Sign Permits and Master Sign Plans are reviewed by the Development Review Board (DRB) as outlined in Section 4.031.

***Applicant's Response: The Owner/Applicant acknowledges that a Master Sign Plan is reviewed by the Development Review Board. Subsequent to this approval, future signage permits are reviewed though a Class I Signage Permit.***

- (.04) Class I Sign Permit. Sign permit requests shall be processed as a Class I Sign Permit when the requested sign or signs conform to a Master Sign Plan or other previous sign approval. In addition, a Minor Adjustment to a Master Sign Plan or other previous sign approval may be approved in connection with a Class I Sign Permit.

- A. Class I Sign Permit Submission Requirements: Application for a Class I Sign Permit shall include two (2) copies of the following along with all required application fees:

1. Completed application form prescribed by the City and signed by the property owner or the property owner's representative,
  2. Sign drawings showing all materials, the sign area and dimensions used to calculate sign areas, and other details sufficient to judge the full scale of the associated sign or signs and related improvements,
  3. Information showing how the proposed sign or signs conform with all applicable code requirements, Master Sign Plans, or other previous sign approvals for the property, and
  4. Information supporting any minor adjustment requests.
- B. Class I Sign Permit Review Criteria: The sign or signs conform with the applicable master sign plan or other previous sign approvals, and applicable code requirements.
- C. Minor Adjustments: Notwithstanding approved Master Sign Plans or other previous sign approvals, as part of a Class I Sign Permit Minor Adjustments may be approved as described in 1. and 2. below. Minor Adjustments are valid only for the Sign Permit with which they are associated and do not carry over to future sign permits or copy changes.
1. Adjustment to Sign Height or Length: Adjustment of not more than ten (10) percent from the sign height (not height from ground) and/or length may be approved for the reasons listed in a. through d. below, unless otherwise specifically prohibited in the Master Sign Plan. Minor adjustments to sign height and length shall not cause the sign to cross the edge of any fascia, architectural element or area of a building facade identified as a sign band. The area of the sign exceeding the height or length as part of a minor adjustment shall not count against the sign area indicated in a Master Sign Plan or other previous sign approval.
    - a. To accommodate the descender on the lower case letters "q, y, p g, or j", not otherwise accommodated by the measurement method used, where the letter matches the font of other letters in the sign, the descender is no more than 1/2 the cap height of the font, and the descender is no wider than the main body of the letter;
    - b. To accommodate stylized fonts where bowls, shoulders, or serifs of the stylized letters extend beyond the cap height;
    - c. To accommodate an arching or other non-straight baseline; or
    - d. To accommodate a federally registered trademark logo where compliance with the defined maximum sign height would result in the cap height of the text in the logo being ninety (90) percent or less of the cap height for letters otherwise allowed. (i.e. if a Master Sign Plan allowed 24" letters and 24" total sign height, and a 24" logo would result in the cap height of the text within the logo being less than 21.6", the total height of the logo could be increased to 26.4")

2. Lateral Adjustment of Building Sign Location: Lateral adjustment of a building sign location identified in drawings or plans for a Master Sign Plan or other sign approval when all of the following are met:
  - a. The lateral distance being moved does not exceed fifty (50) percent of the sign length or ten (10) feet, whichever is greater;
  - b. The exact location is not specifically supported or required by written findings or a condition of approval;
  - c. The sign remains within the same architectural feature and sign band, except if the location is on a pillar, column, or similar narrow architectural support feature, the sign may be moved to a sign band on the architecture feature which it supports if no other sign is already placed in that sign band for the tenant space; and
  - d. The placement maintains any spacing from the edge of an architectural feature, building, or tenant space specifically identified in the Master Sign plan or other sign approval or if no spacing is identified, maintains a definable space between the sign and the edge of architectural features, the tenant space, and building.

**Applicant's Response: *In accordance with this section, Class I Permits are requested when the sign or signs conform to a Master Sign Plan or other previous sign approval.***

- (.05) Class II Sign Permit. **This criterion is not applicable to this application since the Owner/Application will likely only be pursuing Class I Signage Permits that are in conformance with the Master Sign Plan that is currently under consideration.**
- (.06) Class III Sign Permit. **This criterion is not applicable to this application since the Owner/Application will likely only be pursuing Class I Signage Permits that are in conformance with the Master Sign Plan that is currently under consideration.**
- (.07) Master Sign Plans. A Master Sign Plan is required for non-residential developments with three (3) or more tenants. In creating a Master Sign Plan thought should be given to needs of initial tenants as well as the potential needs of future tenants.
  - A. Master Sign Plan Submission Requirements: Applications for Master Sign Plans shall include ten (10) paper and electronic copies of all the submission requirements for Class II and III Sign Permits and the following in addition to all required fees:
    1. A written explanation of the flexibility of the Master Sign Plan for different potential tenant space configurations over time;
    2. A written explanation of the extent to which different sign designs, including those incorporating logos, stylized letters, multiple lines of text, non-straight baselines, or

different materials and illumination will be allowed and if allowed how the flexibility of the master sign plan will allow these different sign designs over time;

3. A written explanation of how the sign plan provides for a consistent and compatible sign design throughout the subject development.

**Applicant's Response:** *The Parkway Woods Business Park development currently contains two (2) primary tenants with the capacity to have 7-10 tenants depending of division of the unoccupied spaces. City code requires a Master Sign Plan for all non-residential developments of three (3) or more tenants. This requirement will be satisfied with the submission of this application submittal, which include the Master Sign Plan.*

***Refer to Section D – Appendices, Appendix 30 – Master Sign Plan for additional information.***

- B. Master Sign Plan Review Criteria: In addition to the review criteria for Class II and Class III Sign Permits, Master Sign Plans shall meet the following criteria:

1. The Master Sign Plan provides for consistent and compatible design of signs throughout the development; and

**Applicant's Response:** *The Master Sign Plan provides for consistent and compatible design of signs throughout the development. This is demonstrated through the use of consistent materials, color and lettering font/style.*

***Refer to Section D – Appendices, Appendix 30 – Master Sign Plan for additional information.***

2. The Master Sign Plan considers future needs, including potential different configurations of tenant spaces and different sign designs, if allowed.

**Applicant's Response:** *The Master Sign Plan considers future needs, including potential different configurations of tenant spaces and different sign designs.*

***Refer to Section D – Appendices, Appendix 30 – Master Sign Plan for additional information.***

- C. Modifications of a Master Sign Plan: Modifications of a Master Sign Plan, other than Minor and Major Adjustments, shall be reviewed the same as a new Master Sign Plan.

**Applicant's Response:** *The Owner/Applicant understand that any future modifications to Master Sign Plan (other than minor and major adjustments) are required to be reviewed as new Master Sign Plan. No modifications are being sought at this time.*

- (.08) Waivers and Variances. Waivers and variances are similar in that they allow deviation from requirements such as area, and height from ground. They differ in that waivers are granted

by the DRB as part of a comprehensive review of the design and function of an entire site to bring about an improved design and variances are granted by either the Planning Director or DRB to relieve a specific hardship caused by the regulations.

- A. Waivers. The DRB may grant waivers for sign area, sign height from ground (no waiver shall be granted to allow signs to exceed thirty-five (35) feet in height), number of signs, or use of electronic changeable copy signs in order to better implement the purpose and objectives of the sign regulations as determined by making findings that all of the following criteria are met:
1. The waiver will result in improved sign design, in regards to both aesthetics and functionality.
  2. The waiver will result in a sign or signs more compatible with and complementary to the overall design and architecture of a site, along with adjoining properties, surrounding areas, and the zoning district than signs allowed without the waiver.
  3. The waiver will result in a sign or signs that improve, or at least do not negatively impact, public safety, especially traffic safety.
  4. Sign content is not being considered when determining whether or not to grant a waiver.

**Applicant's Response: No waivers are being requested as part of the Master Sign Plan.**

- B. Variances.
1. Administrative Variance: In reviewing a Sign Permit the Planning Director may grant or deny a variance to relieve a hardship through the Class II Administrative Review process. Such a variance shall only be approved where the variance does not exceed twenty percent (20%) of area, height, or setback requirements. The Planning Director shall approve such a variance only upon finding that the application complies with all of the required variance criteria listed in Section 4.196.
  2. Other Variances: In addition to the authority of the Planning Director to issue administrative variances as noted above, the Development Review Board may authorize variances from sign requirements of the Code, subject to the standards and criteria listed in Section 4.196.

**Applicant's Response: No waivers are being requested as part of the Master Sign Plan.**

- (.09) Temporary Sign Permits. **This criterion is not applicable to this application since the Owner/Applicant is not pursuing any temporary signage.**
- (.10) Waiver of Documentation. The Planning Director may, in his or her discretion, waive an application document for Class I, Class II, and temporary sign permits where the required information has already been made available to the City, or where the Planning Director

determines the information contained in an otherwise required document is not necessary to review the application.

**Applicant's Response:** *The Owner/Applicant understands that the Planning Director may waive an application document for Class I, Class II, and temporary sign permits where the required information has already been made available to the City.*

#### Section 4.156.03. Sign Measurement

**Applicant's Response:** *The Applicant/Owner has used the measurement standards in this section to design and measure signs. The remainder of this section is eliminated for brevity.*

*Refer to Section D – Appendices, Appendix 30 – Master Sign Plan for additional information on the various sign area sizes.*

**Section 4.156.04. Non-Conforming Signs.** **This criterion is not applicable to this application because all future signage will conformance with the approved Master Sign Plan that is currently being review.**

#### Section 4.156.05. Signs Exempt From Sign Permit Requirements.

- (.01) The following signs are exempt from the permit requirements of this code and do not require sign permits. Unless otherwise specified, the area of the exempted signs shall not be included in the calculations of sign area permitted on a given site:
- A. Traffic or other governmental or directional signs, as may be authorized by the City or other units of government having jurisdiction within the City.
  - B. Signs installed by public utility companies indicating danger, or which serve as an aid to public safety, or which show the location of utilities or public facilities, including underground utilities.
  - C. Flags displayed from permanently-located freestanding or wall-mounted flagpoles that are designed to allow raising and lowering of flags. One site may have up to two (2) exempt flags; no exempt flag may be more than thirty (30) feet in height.

**Applicant's Response:** *The Owner/Applicant understands that certain types of signs are exempt for the Sign Permit requirements.*

- (.02) Other Signs. No sign permit is necessary before placing, constructing or erecting the following signs. However, in all other particulars such signs shall conform to the requirements of applicable Building and Electrical Codes, as well as this Code.
- A. Signs inside a building except for prohibited signs listed in Section 4.156.06.
  - B. Name Plates and Announcements.

1. A sign identifying the name, street address, occupation and/or profession of the occupant of the premises in the aid of public health and safety. One name plate, not exceeding a total of three (3) square feet shall be allowed for each occupant. The name plate shall be affixed to the building.
  2. Announcements posted on a given property (e.g., no smoking, no parking, rules of conduct, etc.) and not intended to be read from off-site, are permitted to be located as needed. Such announcements shall not be considered to be part of the sign allotment for the property.
- C. Directional Signs. Designed for non-changing messages, directional signs facilitate the safe movement of the traveling public. Such signs are subject to the following standards and conditions:
1. The sign area does not exceed three (3) square feet per sign face,
  2. The sign location is not within public rights-of-way and meets City vision clearance requirements;
  3. No sign lighting;
  4. No logo or a logo that does not exceed one (1) square foot in size; and
  5. No more than one (1) directional sign is located on the same tax lot.
- D. Changes of Copy Only, where the graphics contained on an existing sign are changed, but the sign itself is not structurally altered, and no building or electrical permit is required.
- E. Signs not visible from any off-site location.
- F. Holiday lights and decorations, in place between November 15 and January 15.
- G. Signs on scoreboards or ballfields located on public property.
- H. One small decorative banner per dwelling unit placed on site, in residential zones.
- I. Lawn Signs meeting the standards of Table S-1 and the following conditions:
1. Such signs shall not be intentionally illuminated and shall not display movement.
  2. Such signs shall not obscure sight lines of the motoring public, obscure traffic or other government signs, or create a nuisance to the use or occupancy of any property.



3. Lawn signs associated with temporary events may be posted no longer than sixty (60) days before the beginning of an event and must be removed at the event's completion.
  4. Lawn signs not associated with temporary events may be posted for one period of up to sixty (60) days in a calendar year.
  5. Such signs may be up to six (6) feet in height.
  6. Such signs may be one (1) or two (2) sided.
- J. Rigid Signs meeting the standards of Table S-1 and the following conditions:
1. Such signs shall not be intentionally illuminated and shall not display movement.
  2. Such signs shall not obscure sight lines of the motoring public, obscure traffic or other government signs, or create a nuisance to the use or occupancy of any property.
  3. Such signs may be up to six (6) feet in height, except signs on lots with an active construction project (active building permit), which may be up to ten (10) feet in height. (Note that signs exceeding six (6) feet in height typically require building permits.)
  4. Such signs may be one (1), two (2), or three (3) sided.
  5. On Residential and Agriculture zoned lots:
    - a. A rigid sign not associated with an ongoing temporary event may be displayed for no more than sixty (60) days each calendar year.
    - b. A rigid sign associated with an ongoing temporary event may be displayed for the duration of that event. Note: Section 4.156.06 (.01) Q. of this Code prohibits signs associated with temporary events to remain posted after the completion of the event.
  6. On Commercial, Industrial, or Public Facility zoned lots:
    - a. A rigid sign not associated with an ongoing temporary event may be displayed for no more than ninety (90) days each calendar year.
    - b. A rigid sign associated with an ongoing temporary event may be displayed for the duration of that temporary event. Note: Section 4.156.06(.01)(Q.) of this Code prohibits signs associated with temporary events to remain posted after the completion of the event.
    - c. A temporary event must have an end, marked by the occurrence of a specifically anticipated date or happening. A temporary event may not be a part of a

broader, continuing event or of related, serial events. Temporary events shall not be defined by content, but may include isolated merchandise sales or discounts, or availability of real estate for sale or lease.

- K. Signs allowed in Subsections 6.150 (1) and (2) Wilsonville Code for special events.

***Applicant's Response:*** *In accordance with this section, the Owner/Applicant understands that the types of signs listed under items A-K above do not require a sign permit.*

#### **Section 4.156.06. Prohibited Signs**

- (.01) Prohibited Signs. The following signs are prohibited and shall not be placed within the City:
  - A. Search lights, strobe lights, and signs containing strobe lights or other flashing lights, unless specifically approved in a sign permit.
  - B. Obstructing signs, a sign or sign structure such that any portion of its surface or supports will interfere in any way with the free use of any fire escape, exit, hydrant, standpipe, or the exterior of any window; any sign projecting more than twelve (12) inches from a wall, except projecting signs that are specifically permitted through the provisions of this Code.
  - C. Changing image signs, including those within windows.
  - D. Changeable copy signs that use lighting changed digitally, unless specifically approved through a waiver process connected with a Class III Sign Permit or Master Sign Plan. In granting a waiver for a digital changeable copy signs the DRB shall ensure the following criteria will be met:
    - 1. The sign shall be equipped with automatic dimming technology which automatically adjusts the sign's brightness in direct correlation with ambient light conditions and the sign owner shall ensure appropriate functioning of the dimming technology for the life of the sign.
    - 2. The luminance of the sign shall not exceed five thousand (5000) candelas per square meter between sunrise and sunset, and five hundred (500) candelas per square meter between sunset and sunrise.
  - E. Roof signs - signs placed on the top of a building or attached to the building and projecting above the top of that building, unless specifically approved through the temporary sign permit procedures or the architectural design of a building makes the slope of the roof below the peak a practicable location of signs on a building and the general location of signs on the roof is approved by the DRB during Stage II Approval, as applicable, and Site Design Review.
  - F. Signs obstructing vision clearance areas.

- G. Pennants, streamers, festoon lights, balloons, and other similar devices intended to be moved by the wind, unless specifically authorized in an approved sign permit.
- H. Signs attached to trees, public sign posts, or public utility poles, other than those placed by appropriate government agencies or public utilities.
- I. Signs using bare-bulb illumination or signs lighted so that the immediate source of illumination is visible, unless specifically authorized by the Development Review Board or City Council such as Digital Changeable Copy Signs. This is not intended to prohibit the use of neon or LED's as a source of illumination.
- J. Signs that use flame as a source of light or that emit smoke or odors.
- K. Any sign, including a window sign, which is an imitation of or resembles an official traffic sign or signal; and which may include display of words or graphics that are likely to cause confusion for the public, such as "STOP," "GO," "SLOW," "CAUTION," "DANGER," "WARNING," etc.
- L. Any sign, including a window sign, which by reason of its size, location, movements, content, coloring or manner of illumination may be confused with, or construed as, a traffic control device, or which hides from view any traffic sign, signal, or device.
- M. Portable signs, exceeding six (6) square feet of sign area per side, other than those on vehicles or trailers. The display of signs on a vehicle or trailer is prohibited where the vehicle or trailer is not fully operational for use on public roads or where the primary function of the vehicle or trailer is advertising. Examples where the primary function of the vehicle or trailer is advertising include mobile billboards such as those on which advertising space is rented, sold, or leased.
- N. Signs located on public property in violation of Section 4.156.10.
- O. Signs placed on private property without the property owner's permission.
- P. Signs erected or installed in violation of standards prescribed by the City of Wilsonville, State of Oregon or the U.S. government.
- Q. Signs associated with temporary events, after the temporary event is completed.
- R. Any private signs, including window signs, with a luminance greater than five thousand (5000) candelas per square meter between sunrise and sunset and five hundred (500) candelas per square meter between sunset and sunrise.
- S. Video Signs

**Applicant's Response: The Owner/Applicant acknowledges that the types of signs cited from A-S above are prohibited within the City and is not proposing any signs of these types.**

**Section 4.156.07. Sign Regulations In Residential Zones. This criterion is not applicable to this application because the proposed signage is located in an Industrial zone.**

**Section 4.156.08. Sign Regulations in the PDC, PDI, and PF Zones.**

(.01) Freestanding and Ground Mounted Signs:

**A. One freestanding or ground mounted sign is allowed for the first two-hundred (200) linear feet of site frontage.** One additional freestanding or ground mounted sign may be added for through and corner lots having at least two-hundred (200) feet of frontage on one street or right-of-way and one-hundred (100) feet on the other street or right-of-way.

**B. The allowed height above ground of a freestanding or ground mounted sign is twenty (20) feet** except as noted in 1-2 below.

1. The maximum allowed height above ground for signs along the frontage of Interstate 5, and parallel contiguous portions of streets, as identified in Figure S-4, associated with multiple tenants or businesses may be increased by three (3) feet for each tenant space of ten thousand (10,000) square feet or more of gross floor area up to a maximum of thirty-five (35) feet.
2. The allowed height above ground for signs in the PDC-TC Zone, Old Town Overlay Zone, and PDI Zone is eight (8) feet, except those signs along the frontage of Interstate 5 and parallel contiguous portions of streets identified in Figure S-4.

**C. The maximum allowed area for each freestanding or ground-mounted sign is determined based on gross floor area and number of tenant spaces:**

1. For frontages along streets other than those indicated in 2 below sign area allowed is calculated as follows:
  - a. The sign area allowed for signs pertaining to a single tenant:

Gross Floor Area in a Single Building	Maximum Allowed Sign Area
Less than 11,000 sq. ft.	32 sq. ft.
11,000-25,999 sq. ft.	32 sq. ft. + 2 sq. ft. per 1000 sq. ft. of floor area greater than 10,000 rounded down to the nearest 1,000 sq. ft.
26,000 sq. ft. or more	64 sq. ft.

i. For PF (Public Facility) zoned properties adjacent to residential zoned land the maximum allowed area is thirty-two (32) square feet.

**b. The maximum allowed sign area for signs pertaining to multiple tenants or businesses is thirty-two (32) square feet plus the following for each tenant space:**

Gross Floor Area of Tenant Space	Additional Allowed Sign Area for Tenant Space
Less than 1,000 sq. ft.	3 sq. ft.
1,000-10,999	3 sq. ft. + 3 sq. ft. per 1,000 sq. ft. of floor area rounded down to the nearest 1,000 sq. ft.
<b>11,000 sq. ft. or more</b>	<b>32 sq. ft.</b>

- i. The total sign area shall not exceed two hundred (200) square feet, except in the PDC-TC Zone, Old Town Overlay Zone, and **PDI Zone the total sign area shall not exceed eighty (80) square feet.**
  - ii. Though the maximum allowed sign area is calculated based on number of tenant spaces and their size, the content of the sign and area used for different content is at the discretion of the sign owner, except for required addressing.
2. Signs fronting Interstate 5 and parallel contiguous street sections, as identified in Figure S-4.
- a. For signs on properties or within developments with a single tenant or business the sign area allowed is sixty-four (64) square feet.
  - b. For signs on properties or within developments with multiple tenants or businesses the maximum allowed area is sixty-four (64) square feet plus an additional thirty-two (32) square feet for each tenant space of 10,000 square feet or more of gross floor area up to a maximum total sign area of three hundred (300) square feet.
    - i. Though the sign area allowed is calculated based on number of large tenant spaces, the content of the sign and area used for different content is at the discretion of the sign owner, except for any required addressing.

**D. Pole or sign support placement shall be installed in a full vertical position.**

**E. Freestanding and ground mounted signs shall not extend into or above public rights-of-way, parking areas, or vehicle maneuvering areas.**

F. The location of free standing or ground mounted signs located adjacent to or near the Public Right-of-Way shall be in compliance with the City’s Public Works Standards for sight distance clearance. Prior to construction, the location of the sign shall be approved by the City of Wilsonville Engineering Division.

**G. Freestanding and ground mounted signs shall be designed to match or complement the architectural design of buildings on the site.**

- H. For freestanding and ground mounted signs greater than eight (8) feet in height, the width of the sign shall not exceed the height.
- I. Along street frontages in the PDC-TC Zone and Old Town Overlay Zone monument style signs are required.
- J. Freestanding and ground mounted signs shall be no further than fifteen (15) feet from the property line and no closer than two (2) feet from a sidewalk or other hard surface in the public right-of-way.
- K. Except for those signs fronting Interstate 5, freestanding and ground mounted signs shall include the address number of associated buildings unless otherwise approved in writing by the City and the Fire District.
- L. When a sign is designed based on the number of planned tenant spaces it shall remain a legal, conforming sign regardless of the change in the number of tenants or configuration of tenant spaces.

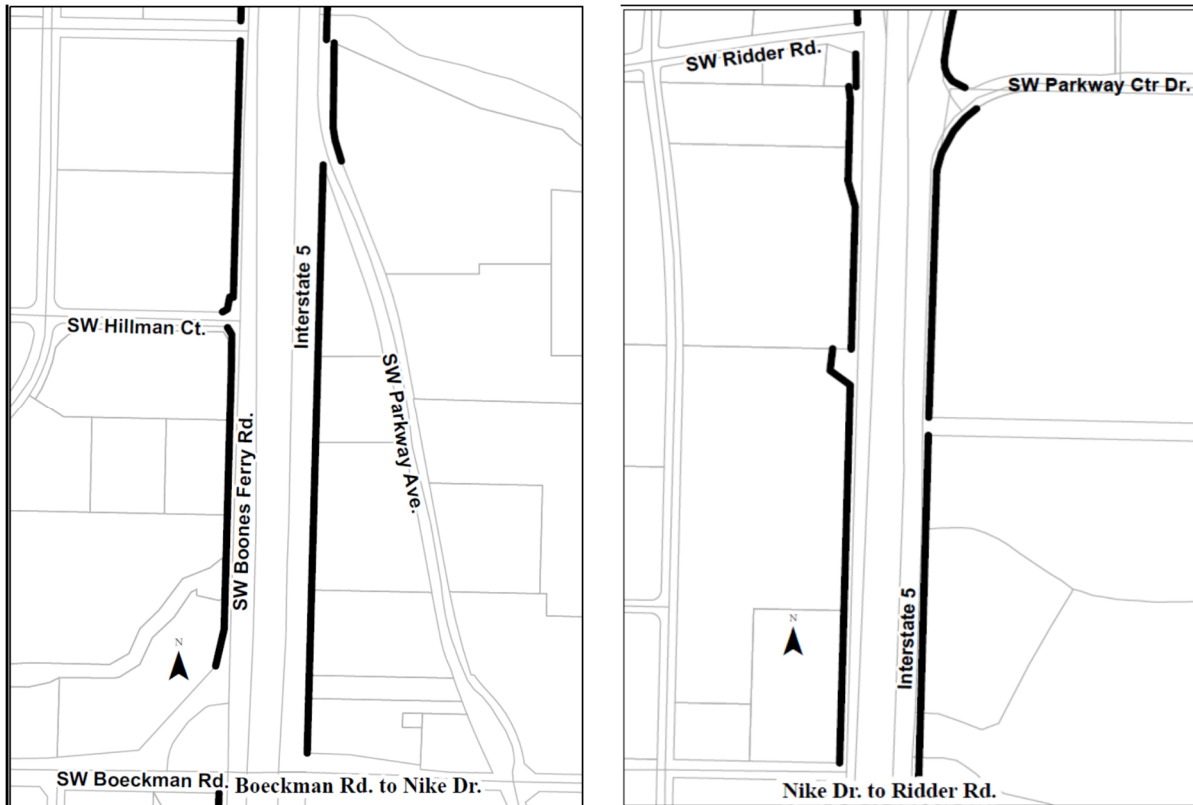

Figure S-4. Interstate 5 and Contiguous Parallel Street Frontages (continued)

***Applicant's Response:*** The sign plan for the site meets these standards for freestanding and ground mounted signs. Monuments signs are proposed to be twenty

*(20) feet high by 3.5 feet wide for a total of 70 square feet. Secondary monument signs are seven (7) feet high by one (1) foot wide. Multi-Tenant signs are proposed to be six (6) feet high by four (4) feet wide for a total of 24 square feet.*

*Refer to Section D – Appendices, Appendix 30 – Master Sign Plan for additional information.*

**(.02) Signs on Buildings.**

**A. Sign Eligible Facades:** Building signs are allowed on a facade of a tenant space or single tenant building when one or more of the following criteria are met:

- 1. The facade has one or more entrances open to the general public;**
- 2. The facade faces a lot line with frontage on a street or private drive with a cross section similar to a public street, and no other buildings on the same lot obstruct the view of the building facade from the street or private drive; or**
- 3. The facade is adjacent to the primary parking area for the building or tenant.**

**B. Sign Area Allowed:**

1. The sign area allowed for all building signs on a sign eligible façade is shown in the table below:

<b>Linear Length of Façade (feet)</b>	<b>Sign Area Allowed*</b>
Less than 16	Area equal to linear length
16 to 24	24 sq. ft.
Greater than 24 to 32	32 sq. ft.
Greater than 32 to 36	Area equal to linear length
Greater than 36 to 72	36 sq. ft.
<b>Greater than 72</b>	<b>36 sq. ft. plus 12 sq. ft. for each 24 linear feet or portion thereof greater than 72 up to a maximum of 200 sq. ft.</b>

*\*Except as noted in 2. through 5. below*

2. The sign area allowed for facades with a primary public entrance or with a frontage along a public street dominated by windows or glazing may be increased by transferring to the façade up to one half (1/2) the sign area allowed for adjacent facades up to fifty (50) square feet. In no case shall the allowed sign area exceed an area equal to the linear length of the façade.
3. The sign area allowed is increased as follows for signs at separate building entrances:

- a. For building entrances open to the general public located at least fifty (50) feet apart on the same facade, the sign area allowed is increased by fifty (50) percent up to fifty (50) square feet.
  - b. For building entrances located less than fifty (50) feet apart on the same facades, the sign area allowed is increased by twenty (20) percent up to twenty (20) square feet.
4. For businesses occupying multiple buildings in a campus setting, sign area shall be limited to that allowed for the largest building, which may then be distributed throughout the campus.
5. If a façade otherwise not sign eligible faces a lot line with frontage on Interstate 5, the applicant can transfer sign area allowed from one (1) of the locations described in a. and b. below. In no case shall the allowed sign area exceed an area equal to the allowed sign area for a sign eligible façade of the same linear length.
- a. The freestanding sign along the Interstate 5 frontage. This generally involves placing building signs on the subject façade in lieu of installing a freestanding sign.
  - b. Adjacent façade up to fifty (50) square feet, when a majority of the adjacent façade from which the sign area is being transferred is visible from Interstate 5.
- 6. Calculating linear length of a façade for the purpose of determining maximum sign area allowed.** For facades of a single tenant building the length the facade measured at the building line, except as noted in a. and b. below. **For multi-tenant buildings the width of the façade of the tenant space shall be measured from the centerline of the party walls or the outer extent of the exterior wall at the building line**, as applicable, except as noted in a. and b. below. Applicants shall provide the dimensions needed to calculate the length. Each tenant space or single occupant building shall not be considered to have more than five (5) total facades.
- a. If a façade is curvilinear, stepped, or otherwise not a straight line, the façade shall be measured by drawing a straight line between the edges of the façade as shown in the figure below.
  - b. For an “L” shaped tenant space or single tenant building the longest leg of the interior of the “L” shall be basis for measuring the length of the L-shaped facade. Sign area allowed based on the longest leg can be distributed between legs.
- C. The length of individual tenant signs shall not exceed seventy-five (75) percent of the length of the facade of the tenant space.**



- D. The height of building signs shall be within a definable sign band, fascia, or architectural feature and allow a definable space between the sign and the top and bottom of the sign band, fascia, or architectural feature.
- E. Types of signs permitted on buildings include wall flat, fascia, projecting, blade, marquee and awning signs. Roof-top signs are prohibited.

***Applicant’s Response:*** *Wall signs will be dependent upon the ultimate number of tenants. Because the development consists of a multi-tenants, some of which are not yet leased, the width of the façade of each tenant space is unknown. For this reason, several locations have been identified for the possible placement of tenant wall signs. Each location will have a maximum sign size of 32 square feet. In no case will tenant signs exceed 200 square feet for any facade.*

*Below is a breakdown of each of the building facades square footage and the maximum square footage of tenant wall signs on each (excluding loading area identification).*

<i>Facade</i>	<i>Façade Length (in Linear Feet)</i>	<i>Facade Area (in Square Feet)</i>	<i>Number of Tenant Signs Proposed</i>	<i>Maximum Square Footage of Tenant Signs Proposed</i>	<i>Percentage of Total Allocated for Tenant Signage</i>
<i>North</i>	<i>1,384</i>	<i>31,316</i>	<i>4</i>	<i>128</i>	<i>0.4%</i>
<i>West</i>	<i>492</i>	<i>10,802</i>	<i>1</i>	<i>32</i>	<i>0.2%</i>
<i>South</i>	<i>1,384</i>	<i>31,276</i>	<i>5</i>	<i>160</i>	<i>0.5%</i>
<i>East</i>	<i>492</i>	<i>10,172</i>	<i>0</i>	<i>0</i>	<i>0.0%</i>
<i>Total</i>	<i>3,752</i>	<i>83,566</i>	<i>10</i>	<i>320</i>	<i>0.3%</i>

*Each of the proposed sign plan for the site meets these standards for building signs.*

*Refer to Section D – Appendices, Appendix 30 – Master Sign Plan for additional information.*

(.03) Additional signs. Notwithstanding the signs allowed based on the site in (.01) and (.02) above, the following signs may be permitted, subject to standards and conditions in this Code:

- A. **Directional Signs:** In addition to exempt directional signs allowed under Subsection 4.156.05 (.02) C. freestanding or ground mounted directional signs six (6) square feet or less in area and four (4) feet or less in height:

1. The signs shall be designed to match or complement the architectural design of buildings on the site;

2. The signs shall only be placed at the intersection of internal circulation drives; and
3. No more than one (1) sign shall be placed per intersection corner with no more than two (2) signs per intersection.

**Applicant's Response: Directional or wayfinding signs will be incorporated into the Master Sign Plan. Each of the signs is proposed to be six (6) feet high by four (4) feet wide for a total of 24 square feet. Wayfinding signs will be disperse throughout the development. Each of these signs will comply with the standards.**

**Refer to Section D – Appendices, Appendix 30 – Master Sign Plan for additional information.**

- B. Planned Development Signs. Up to thirty (32) square feet of the allowed sign area for freestanding signs in a planned development may be used for a separate on-site monument sign or off-site monument sign on an adjacent parcel identifying the Planned Development project.

**Applicant's Response: No Planned Development Signs are proposed on any adjacent parcels.**

- C. Blade Signs. To aid in pedestrian wayfinding, one (1) blade sign, not to exceed six (6) square feet, per facade eligible for building signs. Blade signs over pedestrian accessible areas shall provide a minimum of eight (8) feet of clearance from the ground.

**Applicant's Response: In accordance with this section one (1) blade sign is allowed per facade eligible for building signs**

- D. Fuel or Service Station Price Signs. In addition to the freestanding or ground mounted signs allowed, changeable copy signs shall be allowed for the purpose of advertising fuel prices, subject to the following standards and conditions:
  1. The signs shall have a maximum of eleven (11) square feet in area per face per type of fuel sold and shall be permanently affixed to the building or a freestanding sign.
  2. The signs shall not be considered in calculating the sign area or number of signs allowed.
  3. Signs on fuel pumps shall be permitted, providing that they do not project beyond the outer edge of the pump in any direction.

**Applicant's Response: There are no fuel or service stations located within the proposed development.**

#### **Section 4.156.09. Temporary Signs In All Zones.**

The following temporary signs may be permitted in addition to the permanent signs allowed in different zones and exempt temporary signs unless specifically prohibited in a master sign plan or other sign approval:

- (.01) General Allowance. Except as noted in subsection (.02) below **up to two (2) temporary signs not exceeding a combined total of twenty four (24) square feet may be permitted per lot or non-residential tenant**. Such signs may be banners, rigid signs, lawn signs, portable signs, or other signs of similar construction.

***Applicant's Response:*** *As necessary, the Owner/Applicant may utilize temporary signage on the individual tenant spaces advertising the leasable space an.*

***Refer to Section D – Appendices, Appendix 30 – Master Sign Plan for additional information.***

- (.02) Opening Banner for a New Business or Housing Development. A banner corresponding with the opening of a new business or housing development may be permitted, subject to the following standards and conditions:
- A. One such banner shall be allowed either from the date of issuance of Building Permits until four (4) weeks after issuance of Certificates of Occupancy, or if no Building Permit is issued, for four (4) weeks after occupancy of a new business.
  - B. Such banner may be two-sided but shall not exceed thirty-two (32) square feet per face.
  - C. Such signs shall not be permitted at the same time as general allowance signs in (.01) above.

***Applicant's Response:*** *New tenants may utilize temporary signage on the individual tenant spaces advertising the opening of a new business.*

***Refer to Section D – Appendices, Appendix 30 – Master Sign Plan for additional information.***

- (.03) Annual Event Signs. Up to ten (10) lawn signs may be permitted to be located in the public right-of-way for up to fourteen (14) days if all of the following are met:
- A. Signs will not be located in the areas listed in Subsection 4.156.10 (.01) A. 4.
  - B. The applicant or event has not been issued a permit for and placed signs in the public right-of-way in the previous six (6) months;
  - C. Not more than one (1) other permit has been issued for lawn signs in the right-of-way during the time period the applicant is requesting;
  - D. The event to which the signs pertain is expected to attract two hundred fifty (250) or more people;

- E. The request is not in addition to exempt lawn signs for large special events allowed for in Section 6.150; and
- F. The applicant has indicated on a map the exact locations the signs will be placed and has submitted an application along with the required fee.

***Applicant's Response:*** *The use of Annual Event Signs is unlikely given the types of uses/tenants that allowed within the Planned Development Industrial (PDI) zone district.*

(.04) Inflatable Signs. Inflatable signs may be permitted for a maximum of fifteen (15) days of display use in any calendar year subject to the following standards and conditions:

- A. Does not exceed ten (10) feet in overall height; and
- B. If attached to a building in any manner, it meets applicable building code requirements including consideration of wind loads.

***Applicant's Response:*** *Again, the use of Annual Event Signs is unlikely given the types of uses/tenants that allowed within the Planned Development Industrial (PDI) zone district.*

**Section 4.156.10. Signs on City and ODOT Right-Of-Way.** **This criterion is not applicable to this application since the Owner/Applicant are not placing signage on City or ODOT owned property or right-of-way.**

**Section 4.156.11. Sign Enforcement.** **This criterion is not applicable to this application because the Owner/Applicant is not in violation or shown cause for enforcement.**

**Table S-1**  
*Exempt Lawn and Rigid Sign Allowances*

<u>Sign Location Description</u>		<u>Lawn Signs</u> [see WC 4.156.05 (.02) I.]	<u>Rigid Signs</u> [see WC 4.156.05 (.02) J.]	<u>Maximum Combined Lawn and Rigid Signs</u>
<b>Part 1. General Allowances for Lawn and Rigid Signs</b>				
	<b>Area per sign face</b>	<b>6 sq. ft.</b>	<b>32 sq. ft.</b>	
<b>Commercial, Industrial, or Public Facility zoned lots.<sup>2</sup></b>	<b>Exempt at one time</b>	<b>3 signs per lot</b>	<b>1 sign per lot, plus 1 additional sign if the lot is more than 3 acres in area or has multiple street frontages</b>	<b>3 signs per lot, plus 1 additional rigid sign if the lot is more than 3 acres in area or has multiple street frontages.</b>
<b>Part 2. Additional Special Allowances for Rigid Signs<sup>3</sup></b>				

Lots with <i>active</i> commercial, industrial, public facility, or multi-family construction projects. <sup>4</sup>	Area per sign face	64 sq. ft.
	Exempt at one time	1 sign per lot

- <sup>1</sup> Residential and Agriculture zones include all PDR (Planned Development Residential) zones, along with the R (Residential), RA-H (Residential Agriculture-Holding) zone, and any county-zoned land within Wilsonville City limits. In addition, lots not zoned Residential, but designated exclusively for residential use in an approved Master Plan, shall be considered residentially-zoned for the purposes of this table. This includes residential lots and in the Village Zone.
- <sup>2</sup> **Commercial, Industrial, Public Facility zones include all PDC (Planned Development Commercial), PDI (Planned Development Industrial), and PF (Public Facility) zones. In addition, lots zoned Village, but designated for commercial, mixed-use, or publically-owned use in an approved Master Plan, shall fall under this description category for the purposes of this table.**
- <sup>3</sup> Sign allowances in Part 2 are in addition to the allowances and maximums in Part 1.
- <sup>4</sup> An active construction project means a construction project for which any required building permits have been obtained and for which the City Building Official has not approved building occupancy. When the Building Official issues a temporary Certificate of Occupancy, the construction project shall be considered active until a permanent Certificate of Occupancy is issued. Active construction projects involving churches, private schools, or other non-single-family uses are included in this description.

[Table added by Ord. No. 675, 3/1/10]  
[Sign Regulations revised by Ord. No. 704, 6/18/12.]

## Protection of Natural Features and Other Resources

### Section Contains:

- Section 4.171. General Regulations - Protection of Natural Features and Other Resources

### Section 4.171. General Regulations - Protection of Natural Features and Other Resources.

**(.01) Purpose.** It is the purpose of this Section to prescribe standards and procedures for the use and development of land to assure the protection of valued natural features and cultural resources. The requirements of this Section are intended to be used in conjunction with those of the Comprehensive Plan and other zoning standards. It is further the purpose of this Section:

- A. To protect the natural environmental and scenic features of the City of Wilsonville.**
- B. To encourage site planning and development practices which protect and enhance natural features such as riparian corridors, streams, wetlands, swales, ridges, rock outcroppings, views, large trees and wooded areas.**
- C. To provide ample open space and to create a constructed environment capable and harmonious with the natural environment.**

**Applicant's Response:** *The Owner/Applicant understands that the purpose is to identify standards and procedures for the use and development of land to assure the protection of valued natural features and cultural resources.*

**(.02) General Terrain Preparation:**

- A. All developments shall be planned, designed, constructed and maintained with maximum regard to natural terrain features and topography, especially hillside areas, floodplains, and other significant landforms.
- B. All grading, filling and excavating done in connection with any development shall be in accordance with the Uniform Building Code
- C. In addition to any permits required under the Uniform Building Code, all developments shall be planned, designed, constructed and maintained so as to:
  - l. Limit the extent of disturbance of soils and site by grading, excavation and other land alterations.
  2. Avoid substantial probabilities of: (1) accelerated erosion; (2) pollution, contamination, or siltation of lakes, rivers, streams and wetlands; (3) damage to vegetation; (4) injury to wildlife and fish habitats.

3. Minimize the removal of trees and other native vegetation that stabilize hillsides, retain moisture, reduce erosion, siltation and nutrient runoff, and preserve the natural scenic character.

**Applicant's Response:** *In accordance with this section, the Owner/Applicant acknowledge the City's general policies related to site preparation as identified in items A-C cited above.*

- A. *The proposed improvements have been planned and designed to minimize the impact on the natural terrain and topography. To the extent possible, the sites significant natural resources have been avoided.*
- B. *Site development, including grading, filling and excavating, will be conducted in accordance with local, state and federal requirements. To the extent possible, significant trees such as Oregon White Oak and Ponderosa Pines have been avoided.*

*Refer to Section C – Exhibit Drawings, Exhibit 05 – Grading and Drainage Plan – Overall (Preliminary) for additional information.*

- C. *The proposed improvements, to the extent possible, minimize the removal of significant trees species/vegetation as well as the disturbance of soils through grading and limit the disturbance of soils through grading and excavation.*

(.03) Hillsides: **This criterion is not applicable to this application because there are no areas within the project limits that maintain slopes greater than 25%.**

(.04) Trees and Wooded Areas.

- A. All developments shall be planned, designed, constructed and maintained so that:
  - I. Existing vegetation is not disturbed, injured, or removed prior to site development and prior to an approved plan for circulation, parking and structure location.
  2. **Existing wooded areas, significant clumps/groves of trees and vegetation, and all trees with a diameter at breast height of six inches or greater shall be incorporated into the development plan and protected wherever feasible.**
  3. Existing trees are preserved within any right-of-way when such trees are suitably located, healthy, and when approved grading allows.

**Applicant's Response:** *The purpose of the parking expansion and reconfiguration to improve access and circulation throughout the subject property and to provide loading capability for new flex industrial users.*

*The Owner/Applicant have planned and designed the proposed circulation and surface parking improvements, to the extent possible, to preserve trees with a DBH of 6" and greater into the development plan. All totaled, 296 of the trees will be preserved and have been incorporated into the project. Trees in poor condition due to damage, structural stability and overall health have been identified for removal.*

*In other cases, trees that would be directly affected by the placement of new parking areas and circulation routes or indirectly affected through excessive root damage and/or compaction have also been identified for removal.*

- B. Trees and woodland areas to be retained shall be protected during site preparation and construction according to City Public Works design specifications, by:**
  - 1. Avoiding disturbance of the roots by grading and/or compacting activity.**
  - 2. Providing for drainage and water and air filtration to the roots of trees which will be covered with impermeable surfaces.**
  - 3. Requiring, if necessary, the advisory expertise of a registered arborist/ horticulturist both during and after site preparation.**
  - 4. Requiring, if necessary, a special maintenance, management program to insure survival of specific woodland areas of specimen trees or individual heritage status trees.**

**Applicant's Response:** *Trees identified for preservation during construction will be protected in accordance with the City's Public Works design specifications. At a minimum, this will include avoidance of any disturbance to roots through grading and/or compaction activities. The Arborist Report identifies some basic recommendations regarding tree protection and construction activities near trees identified for protection. In cases where work is unavoidable, the Owner/Applicant will consult with the project Arborist for recommendations on best management practices regarding construction activities within the root zones.*

*Refer to Section C – Exhibit Drawings, Exhibit 05 – Grading and Drainage Plan – Overall (Preliminary); Exhibit 07 – Tree Protection and Removal Plan – Overall (Preliminary), Exhibit 08 – Tree Protection and Removal Plan - Northwest Quadrant (Preliminary), Exhibit 09 – Tree Protection and Removal Plan - Northeast Quadrant (Preliminary), Exhibit 10 – Tree Protection and Removal Plan - Southwest Quadrant (Preliminary) and Exhibit 11 – Tree Protection and Removal Plan - Southeast Quadrant (Preliminary) for additional information.*



(.05) High Voltage Powerline Easements and Rights of Way and Petroleum Pipeline Easements. **This criterion is not applicable to this application because no work is being conducted in the vicinity of the high voltage powerline, north of SW Printer Parkway.**

(.06) Hazards to Safety: Purpose:

- A. To protect lives and property from natural or human-induced geologic or hydrologic hazards and disasters.
- B. To protect lives and property from damage due to soil hazards.
- C. To protect lives and property from forest and brush fires.
- D. To avoid financial loss resulting from development in hazard areas.

***Applicant's Response:*** *There are several hazard trees within the subject property that will be removed because the tree is in poor or very poor condition and pose a safety concern due to their overall health or structure. Of the 312 trees identified for removal, 139 of these are considered in poor health or are nuisance trees.*

***Refer to Section C – Exhibit Drawings, Exhibit 07 – Tree Protection and Removal Plan – Overall (Preliminary), Exhibit 08 – Tree Protection and Removal Plan - Northwest Quadrant (Preliminary), Exhibit 09 – Tree Protection and Removal Plan - Northeast Quadrant (Preliminary), Exhibit 10 – Tree Protection and Removal Plan - Southwest Quadrant (Preliminary) and Exhibit 11 – Tree Protection and Removal Plan - Southeast Quadrant (Preliminary) for additional information.***

***Also refer to Section D – Appendices, Appendix 17 – Arborist Report for additional information on the health and conditions of the trees proposed for removal.***

(.07) Standards for Earth Movement Hazard Areas. **This criterion is not applicable to this application because no work is being conducted in any earth movement hazard area.**

(.08) Standards for Soil Hazard Areas:

- A. Appropriate siting and design safeguards shall insure structural stability and proper drainage of foundation and crawl space areas for development on land with any of the following soil conditions: wet or high water table; high shrink-swell capability; compressible or organic; and shallow depth-to-bedrock.
- B. The principal source of information for determining soil hazards is the State DOGAMI Bulletin 99 and any subsequent bulletins and accompanying maps. Approved site-specific soil studies shall be used to identify the extent and severity of the hazardous conditions on the site, and to update the soil hazards database accordingly.

**Applicant's Response: The Owner/Applicant acknowledges the City's standards for soil hazard areas. While no new buildings are being proposed, the project does include site improvements consisting of the expansion and reconfiguration of circulations area and surface parking. In order to ensure soil stability for these improvements, the Owner/Applicant have enlisted the assistance of a Geotechnical Engineer to provide recommendations on soil compaction, subgrade treatment and pavement design.**

***Refer to Section D – Appendices, Appendix 19 – Geotechnical Report for recommendations of earthwork, structural and pavement design.***

- (.09) Historic Protection. **This criterion is not applicable to this application because there are no known structure, objects or areas of historic, cultural or archeological significance within the subject property.**
- (.10) Alteration and Development. **This criterion is not applicable to this application because there are no known cultural resources within the subject property.**
- (.11) Cultural Resource Designation Criteria: **This criterion is not applicable to this application because there are no known cultural resources within the subject property.**

## Public Safety and Crime Prevention

### Section Contains:

- Section 4.175. Public Safety and Crime Prevention

### Section 4.175. Public Safety and Crime Prevention.

(.01) All developments shall be designed to deter crime and insure public safety.

**Applicant's Response:** *The Owner/Applicant acknowledge that development should be designed to deter crime and ensure public safety. While no new buildings are proposed or expanded, the project does include modifications to site circulation and surface parking areas. The design and location of the drive aisles and parking areas take into consideration issues of visibility and surveillance, particularly with regards to the placement of landscaping.*

(.02) Addressing and directional signing shall be designed to assure identification of all buildings and structures by emergency response personnel, as well as the general public.

**Applicant's Response:** *As part of this application submittal, the Owner/Applicant will be submitting an application for a Master Sign Plan. This plan will address wayfinding as well as other types of signage, including addressing and directional identification for emergency response personnel.*

*Directional and addressing identification will be placed at strategic locations throughout the site to assist police and emergency services as well as the general public navigate through the site.*

*The proposed wayfinding signage is address in the Master Sign Plan. Refer to Section D – Appendices, Appendix 30 – Master Sign Plan for additional information.*

(.03) Areas vulnerable to crime shall be designed to allow surveillance. Parking and loading areas shall be designed for access by police in the course of routine patrol duties.

**Applicant's Response:** *Based on the property's secluded setting, size and likely peak hours of operation, the subject property could be vulnerable to various types of crime.*

*Given these conditions, the new parking and loading areas have taken accessibility and visibility into consideration. The parking and loading areas have been designed to promote high visibility and eliminate any areas that offer opportunities for concealment. The surface parking and loading areas are easily accessible from the adjoining streets (i.e. SW Printer Parkway, SW Parkway Avenue and SW Xerox Drive) as well as the primary internal circulation routes. Each of the surface parking*

***lots and loading areas is open and accessible to police and/or security services.***

***Landscaping along the building facades, within the parking areas and loading areas will consist of high branching trees and lower growing shrubs that will be placed in a manner that maintains visibility of the loading areas from the adjacent drive aisles and precludes areas near the building facades that could offer opportunities for concealment.***

(.04) Exterior lighting shall be designed and oriented to discourage crime.

***Applicant's Response: Lighting will be placed along the building facades and throughout the parking/loading areas in an effort to discourage crime. The lighting will provide sufficient illumination throughout the parking area and along the building facades to discourage crime.***

***Refer to Section C – Exhibit Drawings, Sheet 27 – Site Lighting Plan – Overall (Preliminary) for additional information.***

## Landscaping, Screening, and Buffering

### Section Contains:

- Section 4.176. Landscaping, Screening, and Buffering

### Section 4.176. Landscaping, Screening, and Buffering.

**(.01) Purpose.** This Section consists of landscaping and screening standards and regulations for use throughout the City. The regulations address materials, placement, layout, and timing of installation. The City recognizes the ecological and economic value of landscaping and requires the use of landscaping and other screening or buffering to:

- A. Promote the re-establishment of vegetation for aesthetic, health, erosion control, flood control and wildlife habitat reasons;
- B. Restore native plant communities and conserve irrigation water through establishment, or re-establishment, of native, drought-tolerant plants;**
- C. Mitigate for loss of native vegetation;**
- D. Establish and enhance a pleasant visual character which recognizes aesthetics and safety issues;**
- E. Promote compatibility between land uses by reducing the visual, noise, and lighting impacts of specific development on users of the site and abutting sites or uses;
- F. Unify development and enhance and define public and private spaces;**
- G. Promote the retention and use of existing topsoil and vegetation. Amended soils benefit stormwater retention and promote infiltration;
- H. Aid in energy conservation by providing shade from the sun and shelter from the wind; and
- I. Screen from public view the storage of materials that would otherwise be considered unsightly.
- J. Support crime prevention, create proper sight distance clearance, and establish other safety factors by effective landscaping and screening.
- K. Provide landscaping materials that minimize the need for excessive use of fertilizers, herbicides and pesticides, irrigation, pruning, and mowing to conserve and protect natural resources, wildlife habitats, and watersheds.

**Applicant's Response: The Owner/Applicant understands the purpose of the landscape and screening regulations which is intended to address materials, placement, layout, and timing of installation.**

(.02) Landscaping and Screening Standards.

- A. Subsections “C” through “I,” below, state the different landscaping and screening standards to be applied throughout the City. The locations where the landscaping and screening are required and the depth of the landscaping and screening is stated in various places in the Code.**

***Applicant’s Response:*** *The application of the specific landscape standard is specified in other sections of the code.*

*The “General” landscape standards apply to the site overall. The “Low Screen” landscaping standard would apply to primarily to periphery of the parking lots, particularly those adjacent to the street rights-of-way.*

- B. All landscaping and screening required by this Code must comply with all of the provisions of this Section, unless specifically waived or granted a Variance as otherwise provided in the Code. The landscaping standards are minimum requirements; higher standards can be substituted as long as fence and vegetation-height limitations are met.** Where the standards set a minimum based on square footage or linear footage, they shall be interpreted as applying to each complete or partial increment of area or length (e.g., a landscaped area of between 800 and 1600 square feet shall have two trees if the standard calls for one tree per 800 square feet.

***Applicant’s Response:*** *In accordance with this section, all landscaping and screening required by this Code will comply with all of the provisions of this Section. No variances are being requested.*

**C. General Landscaping Standard.**

- 1. Intent. The General Landscaping Standard is a landscape treatment for areas that are generally open.** It is intended to be applied in situations where distance is used as the principal means of separating uses or developments and landscaping is required to enhance the intervening space. Landscaping may include a mixture of ground cover, evergreen and deciduous shrubs, and coniferous and deciduous trees.
2. Required materials. Shrubs and trees, other than street trees, may be grouped. Ground cover plants must fully cover the remainder of the landscaped area (see Figure 21: General Landscaping). The General Landscaping Standard has two different requirements for trees and shrubs:
  - a. Where the landscaped area is less than 30 feet deep, one tree is required for every 30 linear feet.
  - b. Where the landscaped area is 30 feet deep or greater, one tree is required for every 800 square feet and two high shrubs or three low shrubs are required for every 400 square feet.

**Applicant's Response:** *As necessary, the General landscape standard will be applied to the majority of project area that is not directly adjacent to or includes the expanded and reconfigured circulation and surface parking areas. This landscape treatment will consist of mixture of ground cover, evergreen and deciduous shrubs, and coniferous and deciduous trees.*

*This applies to areas of the site that are greater than 30 feet deep. Of the 838,502 square feet of landscaped area, only about 300,292 square feet would be considered general landscaping. Within these areas, 1 tree is required for every 800 square feet and three low shrubs are required for every 400 square feet. Based on this figure approximately 375 trees and 750 shrubs would be required. This requirement is being satisfied by the presence of 296 trees being preserved and the addition of another 163 mitigation trees.*

*Refer to Section C – Exhibit Drawings, Exhibit 16 – Landscape Plan - Overall (Preliminary), Exhibit 17 – Landscape Plan - Northwest Quadrant (Preliminary), Exhibit 18 – Landscape Plan - Northeast Quadrant (Preliminary), Exhibit 19 – Landscape Plan - Southwest Quadrant (Preliminary) and Exhibit 20 – Landscape Plans - Southeast Quadrant (Preliminary) for additional information.*

D. Low Screen Landscaping Standard.

1. Intent. The Low Screen Landscaping Standard is a landscape treatment that uses a combination of distance and low screening to separate uses or developments. It is intended to be applied in situations where low screening is adequate to soften the impact of one use or development on another, or where visibility between areas is more important than a total visual screen. **The Low Screen Landscaping Standard is usually applied along street lot lines or in the area separating parking lots from street rights-of-way.**
2. **Required materials. The Low Screen Landscaping Standard requires sufficient low shrubs to form a continuous screen three (3) feet high and 95% opaque, year-round. In addition, one tree is required for every 30 linear feet of landscaped area, or as otherwise required to provide a tree canopy over the landscaped area. Ground cover plants must fully cover the remainder of the landscaped area.** A three (3) foot high masonry wall or a berm may be substituted for the shrubs, but the trees and ground cover plants are still required. When applied along street lot lines, the screen or wall is to be placed along the interior side of the landscaped area. (See Figure 22: Low Screen Landscaping).

**Applicant's Response:** *The Low Screen landscaping standard will apply along street lot lines or in the area separating parking lots from street rights-of-way. This area requires sufficient low shrubs to form a continuous screen three (3) feet high and 95% opaque, year-round. In addition, one tree is required for*

**every 30 linear feet of landscaped area. Ground cover plants must fully cover the remainder of the landscaped area.**

**Currently, none of the proposed development is located along and existing street lot line. Similarly, none of the proposed parking areas are located immediately adjacent to a public street right-of-way. If deemed necessary, a continuous landscape screen could be added to the exterior side of the parking areas where it would face the proposed right-of-way along SW Printer Parkway.**

E. Low Berm Landscaping Standard.

1. Intent. The Low Berm Standard is intended to be applied in situations where moderate screening to reduce both visual and noise impacts is needed to protect abutting uses or developments from one-another, and where it is desirable and practical to provide separation by both distance and sight-obscuring materials. This screening is most important where either, or both, of the abutting uses or developments can be expected to be particularly sensitive to noise or visual impacts.
2. Required materials. The Low Berm Standard requires a berm at least two feet six inches (2' 6") high along the interior side of the landscaped area (see Figure 23: Low Berm Landscaping). If the berm is less than three (3) feet high, low shrubs meeting the Low Screen Landscaping Standard, above, are to be planted along the top of the berm, assuring that the screen is at least three (3) feet in height. In addition, one tree is required for every 30 linear feet of berm, or as otherwise required to provide a tree canopy over the landscaped area. Ground cover plants must fully cover the remainder of the landscaped area.

*[Section 4.176 Section (.02)C amended per Ordinance No. 812, 02/22/18]*

**Applicant's Response: None of the proposed improvements will require the use of a Low Berm Landscape Standard.**

F. High Screen Landscaping Standard.

1. Intent. The High Screen Landscaping Standard is a landscape treatment that relies primarily on screening to separate uses or developments. It is intended to be applied in situations where visual separation is required.
2. Required materials. The High Screen Landscaping Standard requires sufficient high shrubs to form a continuous screen at least six (6) feet high and 95% opaque, year-round. In addition, one tree is required for every 30 linear feet of landscaped area, or as otherwise required to provide a tree canopy over the landscaped area. Ground cover plants must fully cover the remainder of the landscaped area. A six (6) foot high masonry wall or a berm may be substituted for the shrubs, but the trees and ground cover plants are still required. When applied along street lot lines, the screen or wall is to be placed along the interior side of the landscaped



area. (See Figure 24: High Screen Landscaping).

**Applicant's Response: *None of the proposed improvements will require the use of a High Screen Landscape Standard. This type of standard is could be used around the new loading areas at the northwest and southwest corners of the building if deemed necessary.***

G. High Wall Standard.

1. Intent. The High Wall Standard is intended to be applied in situations where extensive screening to reduce both visual and noise impacts is needed to protect abutting uses or developments from one-another. This screening is most important where either, or both, of the abutting uses or developments can be expected to be particularly sensitive to noise or visual impacts, or where there is little space for physical separation.
2. Required materials. The High Wall Standard requires a masonry wall at least six (6) feet high along the interior side of the landscaped area (see Figure 25: High Wall Landscaping). In addition, one tree is required for every 30 linear feet of wall, or as otherwise required to provide a tree canopy over the landscaped area. Ground cover plants must fully cover the remainder of the landscaped area.

**Applicant's Response: *The existing loading area/solid waste collection areas currently have a high wall surrounding the service areas. None of the proposed improvements will require the use of a High Wall Standard.***

H. High Berm Standard.

1. Intent. The High Berm Standard is intended to be applied in situations where extensive screening to reduce both visual and noise impacts is needed to protect abutting uses or developments from one-another, and where it is desirable and practical to provide separation by both distance and sight-obscuring materials. This screening is most important where either, or both, of the abutting uses or developments can be expected to be particularly sensitive to noise or visual impacts.
2. Required materials. The High Berm Standard requires a berm at least four (4) feet high along the interior side of the landscaped area (see Figure 26: High Berm Landscaping). If the berm is less than six (6) feet high, low shrubs meeting the Low Screen Landscaping Standard, above, are to be planted along the top of the berm, assuring that the screen is at least six (6) feet in height. In addition, one tree is required for every 30 linear feet of berm, or as otherwise required to provide a tree canopy over the landscaped area. Ground cover plants must fully cover the remainder of the landscaped area.

**Applicant's Response: None of the proposed improvements will require the use of a High Berm Standard. Currently, there is a berm that provides screening and reduces both visual and noise impacts along SW Parkway Avenue.**

I. Partially Sight-Obscuring Fence Standard.

1. Intent. The Partially Sight-Obscuring Fence Standard is intended to provide a tall, but not totally blocked, visual separation. The standard is applied where a low level of screening is adequate to soften the impact of one use or development on another, and where some visibility between abutting areas is preferred over a total visual screen. It can be applied in conjunction with landscape plantings or applied in areas where landscape plantings are not necessary and where nonresidential uses are involved.
2. Required materials. Partially Sight-Obscuring Fence Standard are to be at least six (6) feet high and at least 50% sight-obscuring. Fences may be made of wood (other than plywood or particle-board), metal, bricks, masonry or other permanent materials (see Figure 27: Partially Sight-Obscuring Fence).

**Applicant's Response: None of the proposed improvements will require the use of a Partially Sight-Obscuring Fence Standard.**

J. Fully Sight-Obscuring Fence Standard.

1. Intent. The Fully Sight-Obscuring Fence Standard is intended to provide a totally blocked visual separation. The standard is applied where full visual screening is needed to reduce the impact of one use or development on another. It can be applied in conjunction with landscape plantings or applied in areas where landscape plantings are not necessary.
2. Required materials. Fully sight-obscuring fences are to be at least six (6) feet high and 100% sight-obscuring. Fences may be made of wood (other than plywood or particle-board), metal, bricks, masonry or other permanent materials (see Figure 28: Totally Sight-Obscuring Fence).

**Applicant's Response: The Fully Sight-Obscuring Fence standard is a treatment that is intended to provide a totally blocked visual separation. This type of standard is anticipated around any new area that will be used for solid waste and recycling collection. Although none are currently proposed, an additional area may be required within the southwest loading area as some point in the future.**

- (.03) Landscape Area. Not less than fifteen percent (15%) of the total lot area, shall be landscaped with vegetative plant materials. The ten percent (10%) parking area landscaping required by section 4.155.03(B)(1) is included in the fifteen percent (15%) total lot landscaping requirement.** Landscaping shall be located in at least three separate and distinct areas of the lot, one of which must be in the contiguous frontage area. Planting areas shall be encouraged adjacent to structures. Landscaping shall be used to define,

soften or screen the appearance of buildings and off-street parking areas. Materials to be installed shall achieve a balance between various plant forms, textures, and heights. The installation of native plant materials shall be used whenever practicable. (For recommendations refer to the Native Plant List maintained by the City of Wilsonville).

*[Amended by Ord. # 674 11/16/09]*

***Applicant's Response:*** *Within the Planned Development Industrial (PDI) zone, a minimum of fifteen percent (15%) of the total lot area is required to be landscaped with vegetative plant materials. This can include the ten percent (10%) parking area landscaping requirement. Based on a total size area of 88.23 acres, approximately 13.23 acres is required to be landscaped. Currently, most of the development is already landscaped with the exception of the property located north of Printer Parkway.*

*As part of the proposed improvements, additional landscaping will be required along the perimeter and within the interior of the parking areas. Once completed, a total of 838,502 SF (19.25 Ac.) or 22.8% of the net site area will be left in a natural state or landscaped. This exceeds the required minimum 15% landscaping.*

*Refer to Section C – Exhibit Drawings, Exhibit 16 – Landscape Plan - Overall (Preliminary), Exhibit 17 – Landscape Plan - Northwest Quadrant (Preliminary), Exhibit 18 – Landscape Plan - Northeast Quadrant (Preliminary), Exhibit 19 – Landscape Plan - Southwest Quadrant (Preliminary) and Exhibit 20 – Landscape Plans - Southeast Quadrant (Preliminary) for additional information.*

- (.04) Buffering and Screening. **This criterion is not applicable to this application because there is no residential immediately adjacent to the area identified for the proposed improvements.**
- (.05) Sight-Obscuring Fence or Planting. The use for which a sight-obscuring fence or planting is required shall not begin operation until the fence or planting is erected or in place and approved by the City. A temporary occupancy permit may be issued upon a posting of a bond or other security equal to one hundred ten percent (110%) of the cost of such fence or planting and its installation. (See Sections 4.400 to 4.470 for additional requirements.)

***Applicant's Response:*** *As necessary, the use of a sight obscuring fence of high landscape treatment will be used to screen mixed solid water and recycling areas as well as loading areas.*

**(.06) Plant Materials.**

- A. **Shrubs and Ground Cover.** **All required ground cover plants and shrubs must be of sufficient size and number to meet these standards within three (3) years of planting.** Non-horticultural plastic sheeting or other impermeable surface shall not be placed under mulch. Native topsoil shall be preserved and reused to the extent feasible. Surface mulch or bark dust are to be fully raked into soil of appropriate depth, sufficient

to control erosion, and are confined to areas around plantings. Areas exhibiting only surface mulch, compost or barkdust are not to be used as substitutes for plant areas. [Amended by Ord. # 674 11/16/09]

1. **Shrubs. All shrubs shall be well branched and typical of their type as described in current AAN Standards and shall be equal to or better than 2-gallon containers and 10" to 12" spread.**
2. **Ground cover. Shall be equal to or better than the following depending on the type of plant materials used: gallon containers spaced at 4 feet on center minimum, 4" pot spaced 2 feet on center minimum, 2-1/4" pots spaced at 18 inch on center minimum.** No bare root planting shall be permitted. Ground cover shall be sufficient to cover at least 80% of the bare soil in required landscape areas within three (3) years of planting. Where wildflower seeds are designated for use as a ground cover, the City may require annual re-seeding as necessary.
3. Turf or lawn in non-residential developments. Shall not be used to cover more than ten percent (10%) of the landscaped area, unless specifically approved based on a finding that, due to site conditions and availability of water, a larger percentage of turf or lawn area is appropriate. Use of lawn fertilizer shall be discouraged. Irrigation drainage runoff from lawns shall be retained within lawn areas.
4. Plant materials under trees or large shrubs. Appropriate plant materials shall be installed beneath the canopies of trees and large shrubs to avoid the appearance of bare ground in those locations.
5. Integrate compost-amended topsoil in all areas to be landscaped, including lawns, to help detain runoff, reduce irrigation and fertilizer needs, and create a sustainable, low-maintenance landscape. [Added by Ord. # 674 11/16/09]

**Applicant's Response: In accordance with this section, all shrubs will be well branched and typical of their type as described in current AAN Standards and shall be equal to or better than 2-gallon containers and 10" to 12" spread. Ground covers will either consist of gallon containers spaced at 4 feet on center minimum, 4" pot spaced 2 feet on center minimum, 2-1/4" pots spaced at 18 inch on center minimum.**

***The proposed development intends on utilizing 5 gallon containers for large shrubs, 3 gallon containers for small shrubs and the equivalent of 1 gallon containers for grasses and ground covers.***

***The plan currently proposes the use of eleven (11) different species of shrubs and grasses/turf to be used throughout the parking areas. In addition, four additional shrub species will be used through the plaza along the south side of the building. Ground covers will consist primarily of five (5) species plant materials as well as turf sod.***

*Refer to Section C – Exhibit Drawings, Exhibit 23 – Landscape Details and Plant Schedules for additional information.*

- B. **Trees.** All trees shall be well-branched and typical of their type as described in current American Association of Nurserymen (AAN) Standards and shall be balled and burlapped. The trees shall be grouped as follows:
1. **Primary trees which define, outline or enclose major spaces, such as Oak, Maple, Linden, and Seedless Ash, shall be a minimum of 2" caliper.**
  2. Secondary trees which define, outline or enclose interior areas, such as Columnar Red Maple, Flowering Pear, Flame Ash, and Honeylocust, shall be a minimum of 1-3/4" to 2" caliper.
  3. Accent trees which, are used to add color, variation and accent to architectural features, such as Flowering Pear and Kousa Dogwood, shall be 1-3/4" minimum caliper.
  4. **Large conifer trees such as Douglas Fir or Deodar Cedar shall be installed at a minimum height of eight (8) feet.**
  5. Medium-sized conifers such as Shore Pine, Western Red Cedar or Mountain Hemlock shall be installed at a minimum height of five to six (5 to 6) feet.

***Applicant's Response:*** All trees are required to be balled and burlapped (B&B), well-branched and typical of their type as described in current American Association of Nurserymen (AAN) Standards. Large deciduous trees are required to be a minimum of 2" caliper and large conifer trees are required to be installed at a minimum height of eight (8) feet.

*The proposed development intends on utilizing trees that have a 1-3/4 to 2" caliper for deciduous trees or are 7-8' in height for evergreen trees. The proposed plan currently utilizes seven (7) different species totaling 462 trees. In addition, there are another 275 vine maples planted throughout the bioswales and buffer area.*

*Refer to Section C – Exhibit Drawings, Exhibit 23 – Landscape Details and Plant Schedules (Preliminary) for additional information.*

- C. Where a proposed development includes buildings larger than twenty-four (24) feet in height or greater than 50,000 square feet in footprint area, the Planning Director or the Development Review Board, as applicable, may require larger or more mature plant materials: [Section 4.176 Section (.06) amended per Ordinance No. 812, 02/22/18]

***Applicant's Response:*** There are no new buildings included as part of the proposed improvements.

- D. Street Trees. In order to provide a diversity of species, the Development Review Board may require a mix of street trees throughout a development. Unless the Board waives the requirement for reasons supported by a finding in the record, different types of street trees shall be required for adjoining blocks in a development.
1. All trees shall be standard base grafted, well branched and typical of their type as described in current AAN Standards and shall be balled and burlapped (b&b). Street trees shall be planted at sizes in accordance with the following standards:
    - a. Arterial streets - 3" minimum caliper
    - b. Collector streets - 2" minimum caliper.
    - c. Local streets or residential private access drives - 1-3/4" minimum caliper.  
*[Amended by Ord. 682, 9/9/10]*
    - d. Accent or median tree -1-3/4" minimum caliper.
  2. The following trees and varieties thereof are considered satisfactory street trees in most circumstances; however, other varieties and species are encouraged and will be considered:
    - a. Trees over 50 feet mature height: Quercus garryana (Native Oregon White Oak), Quercus rubra borealis (Red Oak), Acer Macrophyllum (Native Big Leaf Maple), Acer nigrum (Green Column Black Maple), Fraxinus americanus (White Ash), Fraxinus pennsylvannica 'Marshall' (Marshall Seedless Green Ash), Quercus coccinea (Scarlet Oak), Quercus pulustris (Pin Oak), Tilia americana (American Linden).
    - b. Trees under 50 feet mature height: Acer rubrum (Red Sunset Maple), Cornus nuttallii (Native Pacific Dogwood), Gleditsia triacanthos (Honey Locust), Pyrus calleryana 'Bradford' (Bradford Pear), Tilia cordata (Little Leaf Linden), Fraxinus oxycarpa (Flame Ash).
    - c. Other street tree species. Other species may be specified for use in certain situations. For instance, evergreen species may be specified where year-round color is desirable and no adverse effect on solar access is anticipated. Water-loving species may be specified in low locations where wet soil conditions are anticipated. *[Section 4.176(.06)(D.) amended by Ordinance No. 538, 2/21/02.]*

**Applicant's Response: Currently, there are no street trees exist along SW Parkway Avenue or SW Printer Parkway. It is anticipated that as part of future roadway improvements, the City will require the planting of street trees in accordance with the City Public Works standards.**

***No street trees are being proposed as part of the Parkway Woods Business Park Improvements.***

E. Types of Plant Species.

1. **Existing landscaping or native vegetation may be used to meet these standards, if protected and maintained during the construction phase of the development and if the plant species do not include any that have been listed by the City as prohibited.** The existing native and non-native vegetation to be incorporated into the landscaping shall be identified.
2. **Selection of plant materials. Landscape materials shall be selected and sited to produce hardy and drought-tolerant landscaping. Selection shall be based on soil characteristics, maintenance requirements, exposure to sun and wind, slope and contours of the site, and compatibility with other vegetation that will remain on the site.** Suggested species lists for street trees, shrubs and groundcovers shall be provided by the City of Wilsonville.
3. Prohibited plant materials. The City may establish a list of plants that are prohibited in landscaped areas. Plants may be prohibited because they are potentially damaging to sidewalks, roads, underground utilities, drainage improvements, or foundations, or because they are known to be invasive to native vegetation. *[Section 4.176(.06)(E.) amended by Ordinance No. 538, 2/21/02.]*

**Applicant's Response: *The Owner/Applicant understands that the existing landscaped areas and/or native vegetation may be used to meet these standards.***

***The proposed materials have been selected and sited to produce hardy and drought-tolerant landscaping. The selection is based on soil characteristics, maintenance requirements, exposure to sun and wind, slope and contours of the site, and compatibility with other vegetation that will remain on the site.***

F. Tree Credit.

Existing trees that are in good health as certified by an arborist and are not disturbed during construction may count for landscaping tree credit as follows (measured at four and one-half feet above grade and rounded to the nearest inch):

Existing trunk diameter	Number of Tree Credits
18 to 24 inches in diameter	3 tree credits
25 to 31 inches in diameter	4 tree credits
32 inches or greater	5 tree credits

*[Amended by Ord. # 674 11/16/09]*

1. It shall be the responsibility of the owner to use reasonable care to maintain preserved trees. Trees preserved under this section may only be removed if an application for removal permit under Section 4.610.10(01)(H) has been

approved. Required mitigation for removal shall be replacement with the number of trees credited to the preserved and removed tree.

2. Within five years of occupancy and upon notice from the City, the property owner shall replace any preserved tree that cannot be maintained due to disease or damage, or hazard or nuisance as defined in Chapter 6 of this code. The notice shall be based on complete information provided by an arborist. Replacement with the number of trees credited shall occur within one (1) growing season of notice.

***Applicant’s Response: Of the 605 existing trees located on site, 296 will be retained and preserved. Of this amount approximately 47 trees have been incorporated in to the design of the parking lot.***

***In accordance with this section, trees that are in good health and are not disturbed during construction may count for landscaping tree credit. Listed below are the trees eligible for tree credits. Of the 47 identified trees being preserved within the reconfigured and expanded parking, only 23 trees are eligible for tree credits based on their size. In total, the 23 trees provide 90 tree credits.***

***The proposed project is eligible to reduce the overall parking lot tree requirement (204 in total) by 90 based on the available tree credits. However, if this occurred, the project would be unable to meet the tree canopy coverage requirements. Therefore, no tree credits will be applied to the required tree totals.***

	Tree No.	DBH	Common Name	Scientific Name	Number of Tree Credit
1	3770	11	Japanese black pine	<i>Pinus thunbergii</i>	
2	3774	12	Japanese black pine	<i>Pinus thunbergii</i>	
3	3776	11	Japanese black pine	<i>Pinus thunbergii</i>	
4	3788	6	ponderosa pine	<i>Pinus ponderosa</i>	
5	3790	7	ponderosa pine	<i>Pinus ponderosa</i>	
6	3792	12	Norway maple	<i>Acer platanoides</i>	
7	6771	14	Norway maple	<i>Acer platanoides</i>	
8	7151	17	Norway maple	<i>Acer platanoides</i>	
9	7307	9	Oregon white oak	<i>Quercus garryana</i>	
10	7309	5	black hawthorn	<i>Crataegus douglasii</i>	
11	<b>7310</b>	<b>24</b>	<b>Oregon white oak</b>	<b><i>Quercus garryana</i></b>	3
12	7311	6	Oregon white oak	<i>Quercus garryana</i>	
13	7312	12	Oregon white oak	<i>Quercus garryana</i>	
14	7517	<b>29</b>	<b>ponderosa pine</b>	<b><i>Pinus ponderosa</i></b>	4



15	7518	27	ponderosa pine	<i>Pinus ponderosa</i>	4
16	7519	24	ponderosa pine	<i>Pinus ponderosa</i>	3
17	7520	28	ponderosa pine	<i>Pinus ponderosa</i>	4
18	7521	17	ponderosa pine	<i>Pinus ponderosa</i>	
19	7529	29	ponderosa pine	<i>Pinus ponderosa</i>	4
20	7660	26	ponderosa pine	<i>Pinus ponderosa</i>	4
21	7665	16	ponderosa pine	<i>Pinus ponderosa</i>	
22	7697	30	ponderosa pine	<i>Pinus ponderosa</i>	4
23	7700	29	ponderosa pine	<i>Pinus ponderosa</i>	4
24	7702	30	ponderosa pine	<i>Pinus ponderosa</i>	4
25	8328	27	ponderosa pine	<i>Pinus ponderosa</i>	4
26	8473	26	ponderosa pine	<i>Pinus ponderosa</i>	4
27	8475	28	ponderosa pine	<i>Pinus ponderosa</i>	4
28	8480	22	Oregon white oak	<i>Quercus garryana</i>	3
29	8481	17	Oregon white oak	<i>Quercus garryana</i>	
30	8482	6	Douglas-fir	<i>Pseudotsuga menziesii</i>	
31	8483	23	Oregon white oak	<i>Quercus garryana</i>	3
32	8492	19	Oregon white oak	<i>Quercus garryana</i>	
33	8499	53	Oregon white oak	<i>Quercus garryana</i>	5
34	8502	30	Douglas-fir	<i>Pseudotsuga menziesii</i>	4
35	8505	11	Douglas-fir	<i>Pseudotsuga menziesii</i>	
36	8509	6	Douglas-fir	<i>Pseudotsuga menziesii</i>	
37	8516	29	Douglas-fir	<i>Pseudotsuga menziesii</i>	4
38	8536	5	sweet cherry	<i>Prunus avium</i>	
39	9211	11,6	Oregon white oak	<i>Quercus garryana</i>	
40	9212	12	Oregon white oak	<i>Quercus garryana</i>	
43	9339	25	Oregon white oak	<i>Quercus garryana</i>	4
41	9352	32	red oak	<i>Quercus rubra</i>	5
42	9353	26	red oak	<i>Quercus rubra</i>	4
44	9673	12	Oregon white oak	<i>Quercus garryana</i>	
45	9674	23	Oregon white oak	<i>Quercus garryana</i>	3
46	9805	35	Oregon white oak	<i>Quercus garryana</i>	5
47	10166	17	Oregon ash	<i>Fraxinus latifolia</i>	
<b>TOTAL</b>					<b>90</b>

G. Exceeding Standards. Landscape materials that exceed the minimum standards of this Section are encouraged, provided that height and vision clearance requirements are met. [Amended by Ordinance No. 538, 2/21/02.]

**Applicant's Response:** *The Owner/Applicant understands that the standards identified in this section are the minimum required by code. It is further understood that the City encourages Owner/Applicant to exceed these standards with the understanding that the height and vision clearance requirement still need to be met.*

- H. Compliance with Standards. The burden of proof is on the applicant to show that proposed landscaping materials will comply with the purposes and standards of this Section. [Amended by Ordinance No. 538, 2/21/02.]

**Applicant's Response:** *In accordance with this section, the Owner/Applicant acknowledges that it is the burden of the Owner/Applicant to show that proposed landscaping materials will comply with the purposes and standards.*

*Refer to Section C – Exhibit Drawings, Exhibit 16 – Landscape Plan - Overall (Preliminary), Exhibit 17 – Landscape Plan - Northwest Quadrant (Preliminary), Exhibit 18 – Landscape Plan - Northeast Quadrant (Preliminary), Exhibit 19 – Landscape Plan - Southwest Quadrant (Preliminary) and Exhibit 20 – Landscape Plans - Southeast Quadrant (Preliminary) for additional information.*

(.07) Installation and Maintenance.

- A. **Installation. Plant materials shall be installed to current industry standards and shall be properly staked to assure survival.** Support devices (guy wires, etc.) shall not be allowed to interfere with normal pedestrian or vehicular movement.

**Applicant's Response:** *All plant materials will be installed to current industry standards and will be properly staked to assure survival.*

- B. Maintenance. Maintenance of landscaped areas is the on-going responsibility of the property owner. Any landscaping installed to meet the requirements of this Code, or any condition of approval established by a City decision-making body acting on an application, shall be continuously maintained in a healthy, vital and acceptable manner. Plants that die are to be replaced in kind, within one growing season, unless appropriate substitute species are approved by the City. Failure to maintain landscaping as required in this Section shall constitute a violation of this Code for which appropriate legal remedies, including the revocation of any applicable land development permits, may result.

**Applicant's Response:** *In accordance with this section, maintenance of landscaped areas is the sole responsibility of the property owner. Plants that die are to be replaced in kind, within one growing season, unless appropriate substitute species are approved by the City.*

- C. Irrigation. The intent of this standard is to assure that plants will survive the critical establishment period when they are most vulnerable due to a lack of

watering and also to assure that water is not wasted through unnecessary or inefficient irrigation. Approved irrigation system plans shall specify one of the following:

1. **A permanent, built-in, irrigation system with an automatic controller. Either a spray or drip irrigation system, or a combination of the two, may be specified.**
2. **A permanent or temporary system designed by a landscape architect licensed to practice in the State of Oregon, sufficient to assure that the plants will become established and drought-tolerant.**
3. Other irrigation system specified by a licensed professional in the field of landscape architecture or irrigation system design.
4. A temporary permit issued for a period of one year, after which an inspection shall be conducted to assure that the plants have become established. Any plants that have died, or that appear to the Planning Director to not be thriving, shall be appropriately replaced within one growing season. An inspection fee and a maintenance bond or other security sufficient to cover all costs of replacing the plant materials shall be provided, to the satisfaction of the Community Development Director. Additionally, the applicant shall provide the City with a written license or easement to enter the property and cause any failing plant materials to be replaced.

***Applicant's Response:*** *The landscaping installed as part of the proposed improvements will be watered through an automatic irrigation system designed by a licensed landscape architect or irrigation contractor.*

***Also refer to Section C – Exhibit Drawings, Exhibit 23 – Landscape Details and Plant Schedules (Preliminary) for planting materials water use requirements.***

- D. Protection. All required landscape areas, including all trees and shrubs, shall be protected from potential damage by conflicting uses or activities including vehicle parking and the storage of materials.

***Applicant's Response:*** *The required landscape areas, including all trees and shrubs, will be protected from potential damage by conflicting uses or activities including vehicle parking and the storage of materials*

- (.08) Landscaping on Corner Lots. All landscaping on corner lots shall meet the vision clearance standards of Section 4.177. If high screening would ordinarily be required by this Code, low screening shall be substituted within vision clearance areas. Taller screening may be required outside of the vision clearance area to mitigate for the reduced height within it.

***Applicant's Response:*** *In accordance with this section, all landscaping on corner lots will comply with the vision clearance standards.*

*Refer to Section C – Exhibit Drawings, Exhibit 16 – Landscape Plan - Overall (Preliminary), Exhibit 17 – Landscape Plan - Northwest Quadrant (Preliminary), Exhibit 18 – Landscape Plan - Northeast Quadrant (Preliminary), Exhibit 19 – Landscape Plan - Southwest Quadrant (Preliminary) and Exhibit 20 – Landscape Plans - Southeast Quadrant (Preliminary) for additional information.*

**(.09) Landscape Plans. Landscape plans shall be submitted showing all existing and proposed landscape areas. Plans must be drawn to scale and show the type, installation size, number and placement of materials. Plans shall include a plant material list. Plants are to be identified by both their scientific and common names. The condition of any existing plants and the proposed method of irrigation are also to be indicated. Landscape plans shall divide all landscape areas into the following categories based on projected water consumption for irrigation:**

- A. High water usage areas (+/- two (2) inches per week): small convoluted lawns, lawns under existing trees, annual and perennial flower beds, and temperamental shrubs;
- B. Moderate water usage areas (+/- one (1) inch per week): large lawn areas, average water-using shrubs, and trees;
- C. Low water usage areas (Less than one (1) inch per week, or gallons per hour): seeded field grass, swales, native plantings, drought-tolerant shrubs, and ornamental grasses or drip irrigated areas.
- D. Interim or unique water usage areas: areas with temporary seeding, aquatic plants, erosion control areas, areas with temporary irrigation systems, and areas with special water-saving features or water harvesting irrigation capabilities.

These categories shall be noted in general on the plan and on the plant material list.

**Applicant's Response: Landscape plans include the elements required by this section.**

*Refer to Section C – Exhibit Drawings, Exhibit 16 – Landscape Plan - Overall (Preliminary), Exhibit 17 – Landscape Plan - Northwest Quadrant (Preliminary), Exhibit 18 – Landscape Plan - Northeast Quadrant (Preliminary), Exhibit 19 – Landscape Plan - Southwest Quadrant (Preliminary) and Exhibit 20 – Landscape Plans - Southeast Quadrant (Preliminary) for additional information.*

*The City also requires that the landscape plans identify the water consumption areas. All of the plant materials selected fall the low water consumption category, however some areas within the plaza and beneath the heavily treed areas may require higher water consumption. Conversely, native plantings and drought tolerant species will lower water consumption.*

***Also refer to Section C – Exhibit Drawings, Exhibit 23 – Landscape Details and Plant Schedules (Preliminary) for planting materials water use requirements.***

- (.10) Completion of Landscaping. The installation of plant materials may be deferred for a period of time specified by the Board or Planning Director acting on an application, in order to avoid hot summer or cold winter periods, or in response to water shortages.

In these cases, a temporary permit shall be issued, following the same procedures specified in subsection (.07)(C)(3), above, regarding temporary irrigation systems. No final Certificate of Occupancy shall be granted until an adequate bond or other security is posted for the completion of the landscaping, and the City is given written authorization to enter the property and install the required landscaping, in the event that the required landscaping has not been installed. The form of such written authorization shall be submitted to the City Attorney for review.

***Applicant's Response: Depending upon the construction period, a request to defer the installation of plant materials may be submitted, in order to avoid hot summer or cold winter periods, or in response to water shortages.***

- (.11) Street Trees Not Typically Part of Site Landscaping. Street trees are not subject to the requirements of this Section and are not counted toward the required standards of this Section. Except, however, that the Development Review Board may, by granting a waiver or variance, allow for special landscaping within the right-of-way to compensate for a lack of appropriate on-site locations for landscaping. See subsection (.06), above, regarding street trees.

***Applicant's Response: Again, no street trees are being proposed as part of the Parkway Woods Business Park Improvements. However, it is anticipated that as part of future roadway improvements, the City will require the planting of street trees in accordance with the City Public Works standards.***

- (.12) Mitigation and Restoration Plantings. A mitigation plan is to be approved by the City's Development Review Board before the destruction, damage, or removal of any existing native plants. Plantings intended to mitigate the loss of native vegetation are subject to the following standards. Where these standards conflict with other requirements of this Code, the standards of this Section shall take precedence. The desired effect of this section is to preserve existing native vegetation.

- A. Plant Sources. Plant materials are to be native and are subject to approval by the City. They are to be non-clonal in origin; seed source is to be as local as possible, and plants must be nursery propagated or taken from a pre-approved transplantation area. All of these requirements are to be addressed in any proposed mitigation plan.

***Applicant's Response: As previously mentioned, the Owner/Applicant is proposing plant 302 trees as mitigation for tree removal. All totaled, 462 trees will be***

***planted throughout the site. Tree replacement is shown on the landscape plan.***

***Refer to Section C – Exhibit Drawings, Exhibit 16 – Landscape Plan - Overall (Preliminary), Exhibit 17 – Landscape Plan - Northwest Quadrant (Preliminary), Exhibit 18 – Landscape Plan - Northeast Quadrant (Preliminary), Exhibit 19 – Landscape Plan - Southwest Quadrant (Preliminary) and Exhibit 20 – Landscape Plans - Southeast Quadrant (Preliminary) for additional information.***

- B. Plant Materials. The mitigation plan shall specify the types and installation sizes of plant materials to be used for restoration. Practices such as the use of pesticides, fungicides, and fertilizers shall not be employed in mitigation areas unless specifically authorized and approved.

***Applicant's Response: Plant materials will consist of a variety of plant materials. Due to the number of trees proposed, the proposed tree mitigation plan includes 462, including 6 Ponderosa Pines and 5 Oregon White Oaks.***

***Refer to Section C – Exhibit Drawings, Exhibit 23 – Landscape Details and Plant Schedules (Preliminary) for additional information.***

- C. Installation. Install native plants in suitable soil conditions. Plant materials are to be supported only when necessary because of extreme winds at the site. Where support is necessary, all stakes, guy wires or other measures are to be removed as soon as the plants can support themselves. Protect from animal and fowl predation and foraging until establishment.

***Applicant's Response: The Owner/Applicant understands that the mitigation plantings need to be installed in suitable soil conditions and property supports through stakes, guy wires or other measures. The mitigation plant materials will be similar to those materials being removed.***

***Refer to Section C – Exhibit Drawings, Exhibit 24 – Landscape Details and Plant Schedules (Preliminary) for additional information.***

- D. Irrigation. Permanent irrigation systems are generally not appropriate in restoration situations, and manual or temporary watering of new plantings is often necessary. The mitigation plan shall specify the method and frequency of manual watering, including any that may be necessary after the first growing season.

***Applicant's Response: The mitigation areas will be irrigated through a temporary water system until they are fully established.***

- E. Monitoring and Reporting. Monitoring of native landscape areas is the on-going responsibility of the property owner. Plants that die are to be replaced in kind and quantity within one year. Written proof of the survival of all plants shall be required to be submitted to the City's Planning Department one year after the planting is completed.

**Applicant's Response:** *In accordance with this section, the Owner/Applicant understand that monitoring of native landscape areas is the on-going responsibility of the property owner.*

## Street Improvement Standards

### Section Contains:

- Section 4.177. Street Improvement Standards

### Section 4.177. Street Improvement Standards.

This section contains the City's requirements and standards for pedestrian, bicycle, and transit facility improvements to public streets, or within public easements.

**The purpose of this section is to ensure that development, including redevelopment, provides transportation facilities that are safe, convenient, and adequate in rough proportion to their impacts.**

- (.01) Development and related public facility improvements shall comply with the standards in this section, the Wilsonville Public Works Standards, and the Transportation System Plan, in rough proportion to the potential impacts of the development. Such improvements shall be constructed at the time of development or as provided by Section 4.140, except as modified or waived by the City Engineer for reasons of safety or traffic operations.

**Applicant's Response: While some future street right-of-way dedications have been illustrated on the proposed site plan, no street improvements are being proposed.**

- (.02) Street Design Standards.

- A. All street improvements and intersections shall provide for the continuation of streets through specific developments to adjoining properties or subdivisions.
1. Development shall be required to provide existing or future connections to adjacent sites through the use of access easements where applicable. Such easements shall be required in addition to required public street dedications as required in Section 4.236(.04).

**Applicant's Response: No street improvements are being proposed as part of the Parkway Woods Business Park improvements project.**

- B. The City Engineer shall make the final determination regarding right-of-way and street element widths using the ranges provided in Chapter 3 of the Transportation System Plan and the additional street design standards in the Public Works Standards.

**Applicant's Response: SW Parkway Avenue does not currently have sufficient right-of-way to accommodate the Arterial roadway standard, the design, however, illustrates the ultimate right-of-way location and site improvements do not encroach on this future right-of-way.**

***Eventually, SW Printer Parkway will become a public roadway. Based on recent conversations with the City, they would like a 51 foot right-***



***of-way along SW Printer Parkway to accommodate the three travel lands and two bike lanes plus 18 feet for a shared use path.***

C. Rights-of-way.

1. Prior to issuance of a Certificate of Occupancy Building permits or as a part of the recordation of a final plat, the City shall require dedication of rights-of-way in accordance with the Transportation System Plan. All dedications shall be recorded with the County Assessor's Office.
2. The City shall also require a waiver of remonstrance against formation of a local improvement district, and all non-remonstrances shall be recorded in the County Recorder's Office as well as the City's Lien Docket, prior to issuance of a Certificate of Occupancy Building Permit or as a part of the recordation of a final plat.
3. In order to allow for potential future widening, a special setback requirement shall be maintained adjacent to all arterial streets. The minimum setback shall be 55 feet from the centerline or 25 feet from the right-of-way designated on the Master Plan, whichever is greater.

***Applicant's Response: SW Parkway Avenue is defined as a Minor Arterial roadway. The right-of-way width for a Minor Arterial roadway ranges between 73 feet and 81 feet. The current right-of-way width is 87 feet. Based on this, it appears that there is sufficient right-of-way to accommodate the full buildout of SW Parkway Avenue.***

***The City has identified SW Printer Parkway as a public street (i.e. collector street) in their Transportation System Plan. The right-of-way width for a Collector roadway ranges between 76 feet and 93 feet. Currently, there is no public right-of-way along SW Printer Parkway. However, there is a 40 foot wide public access easement along with an 8 foot public utility easement on either side.***

***Again, based on recent conversations with the City, they would like a dedication of 50 feet along SW Printer Parkway to accommodate the three travel lands and two bike lanes plus 18 feet for a shared use path.***

- D. Dead-end Streets. New dead-end streets or cul-de-sacs shall not exceed 200 feet in length, unless the adjoining land contains barriers such as existing buildings, railroads or freeways, or environmental constraints such as steep slopes, or major streams or rivers, that prevent future street extension and connection. A central landscaped island with rainwater management and infiltration are encouraged in cul-de-sac design. No more than 25 dwelling units shall take access to a new dead-end or cul-de-sac street unless it is determined that the traffic impacts on adjacent streets will not exceed those from a development of 25 or fewer units. All other dimensional standards of dead-end streets shall be governed by the Public Works Standards. Notification that the street is planned

for future extension shall be posted on the dead-end street. [Amended by Ord. # 674  
11/16/09]

**Applicant's Response: There are no dead end streets identified within the subject property.**

E. Corner or clear vision area.

1. A clear vision area which meets the Public Works Standards shall be maintained on each corner of property at the intersection of any two streets, a street and a railroad or a street and a driveway. However, the following items shall be exempt from meeting this requirement:
  - a. Light and utility poles with a diameter less than 12 inches.
  - b. Trees less than 6" d.b.h., approved as a part of the Stage II Site Design, or administrative review.
  - c. Except as allowed by b., above, an existing tree, trimmed to the trunk, 10 feet above the curb.
  - d. Official warning or street sign.
  - e. Natural contours where the natural elevations are such that there can be no cross-visibility at the intersection and necessary excavation would result in an unreasonable hardship on the property owner or deteriorate the quality of the site.

**Applicant's Response: In accordance with this section, a clear vision area will be maintained at each corner of the property where two streets intersect or a street and driveway intersect. This condition would apply to the intersection of SW Parkway Avenue/SW Printer Parkway and SW Parkway Avenue/SW Xerox Drive.**

F. Vertical clearance - a minimum clearance of 12 feet above the pavement surface shall be maintained over all streets and access drives.

**Applicant's Response: The Owner/Applicant will maintain a minimum vertical clearance above the pavement surface of a 12 feet along the streets and access drives.**

G. Interim improvement standard. It is anticipated that all existing streets, except those in new subdivisions, will require complete reconstruction to support urban level traffic volumes. However, in most cases, existing and short-term projected traffic volumes do not warrant improvements to full Master Plan standards. Therefore, unless otherwise specified by the Development Review Board, the following interim standards shall apply.

1. Arterials - 24 foot paved, with standard sub-base. Asphalt overlays are generally considered unacceptable, but may be considered as an interim improvement based

on the recommendations of the City Engineer, regarding adequate structural quality to support an overlay.

2. Half-streets are generally considered unacceptable. However, where the Development Review Board finds it essential to allow for reasonable development, a half-street may be approved. Whenever a half-street improvement is approved, it shall conform to the requirements in the Public Works Standards:
3. When considered appropriate in conjunction with other anticipated or scheduled street improvements, the City Engineer may approve street improvements with a single asphalt lift. However, adequate provision must be made for interim storm drainage, pavement transitions at seams and the scheduling of the second lift through the Capital Improvements Plan. *[Amended by Ord. 610, 5/1/06]*

***Applicant's Response:*** *The required street improvements associated with the proposed improvements do not include any interim improvements.*

**(.03) Sidewalks. Sidewalks shall be provided on the public street frontage of all development.**

Sidewalks shall generally be constructed within the dedicated public right-of-way, but may be located outside of the right-of-way within a public easement with the approval of the City Engineer.

- A. Sidewalk widths shall include a minimum through zone of at least five feet. The through zone may be reduced pursuant to variance procedures in Section 4.196, a waiver pursuant to Section 4.118, or by authority of the City Engineer for reasons of traffic operations, efficiency, or safety.
- B. Within a Planned Development, the Development Review Board may approve a sidewalk on only one side. If the sidewalk is permitted on just one side of the street, the owners will be required to sign an agreement to an assessment in the future to construct the other sidewalk if the City Council decides it is necessary.

***Applicant's Response:*** *The proposal does not involve improvements within the public right-of-way.*

**(.04) Bicycle Facilities. Bicycle facilities shall be provided to implement the Transportation System Plan, and may include on-street and off-street bike lanes, shared lanes, bike boulevards, and cycle tracks.** The design of on-street bicycle facilities will vary according to the functional classification and the average daily traffic of the facility.

***Applicant's Response:*** *The proposal does not involve improvements within the public right-of-way. Ultimately, bike lanes will be required on both SW Parkway Avenue and SW Printer Parkway, but are not included as part of this project.*

**(.05) Multiuse Pathways. Pathways may be in addition to, or in lieu of, a public street. Paths that are in addition to a public street shall generally run parallel to that street, and shall be designed in accordance with the Public Works Standards or as specified by the City**

**Engineer.** Paths that are in lieu of a public street shall be considered in areas only where no other public street connection options are feasible, and are subject to the following standards.

- A. Paths shall be located to provide a reasonably direct connection between likely pedestrian and bicyclist destinations. Additional standards relating to entry points, maximum length, visibility, and path lighting are provided in the Public Works Standards.
- B. To ensure ongoing access to and maintenance of pedestrian/bicycle paths, the City Engineer will require dedication of the path to the public and acceptance of the path by the City as public right-of-way; or creation of a public access easement over the path.

**Applicant's Response:** *As previously mentioned, SW Printer Parkway has been identified as a Collector roadway. One of the elements of the standard roadway cross section for this type of street is a shared use path. This element parallels the full length of SW Printer Parkway from SW Parkway Avenue to SW Canyon Creek Road.*

*While no street improvements are proposed as part of this application, a shared path will eventually be developed in accordance with the collector street design for this roadway.*

(.06) Transit Improvements

Development on sites that are adjacent to or incorporate major transit streets shall provide improvements as described in this section to any bus stop located along the site's frontage, unless waived by the City Engineer for reasons of safety or traffic operations. Transit facilities include bus stops, shelters, and related facilities. Required transit facility improvements may include the dedication of land or the provision of a public easement.

- A. Development shall at a minimum provide:
  - 1. Reasonably direct pedestrian connections, as defined by Section 4.154, between building entrances and the transit facility and between buildings on the site and streets adjoining transit stops.
  - 2. Improvements at major transit stops. Improvements may include intersection or mid-block traffic management improvements to allow for pedestrian crossings at major transit stops.
- B. Developments generating an average of 49 or more pm peak hour trips shall provide bus stop improvements per the Public Works Standards. Required improvements may include provision of benches, shelters, pedestrian lighting; or provision of an easement or dedication of land for transit facilities.
- C. In addition to the requirements of 4.177(.06)(A.)(2.), development generating more than 199 pm peak hour trips on major transit streets shall provide a bus pullout, curb

extension, and intersection or mid-block traffic management improvements to allow for pedestrian crossings at major transit stops.

- D. In addition to the requirements of 4.177(.06)(A.) and (B.), development generating more than 500 pm peak-hour trips on major transit streets shall provide on-site circulation to accommodate transit service.

***Applicant's Response:*** *While a local transit authority maintains a stop at the west end of the building, no new transit facilities are proposed as part of this application.*

(.07) Residential Private Access Drives. **This criterion is not applicable to this application because the subject property does not contain any residential private accesses.**

**(.08). Access Drive and Driveway Approach Development Standards.**

- A. An access drive to any proposed development shall be designed to provide a clear travel lane free from any obstructions.
- B. Access drive travel lanes shall be constructed with a hard surface capable of carrying a 23-ton load.
- C. Where emergency vehicle access is required, approaches and driveways shall be designed and constructed to accommodate emergency vehicle apparatus and shall conform to applicable fire protection requirements. The City may restrict parking, require signage, or require other public safety improvements pursuant to the recommendations of an emergency service provider.**
- D. Secondary or emergency access lanes may be improved to a minimum 12 feet with an all-weather surface as approved by the Fire District. All fire lanes shall be dedicated easements.**
- E. Minimum access requirements shall be adjusted commensurate with the intended function of the site based on vehicle types and traffic generation.
- F. The number of approaches on higher classification streets (e.g., collector and arterial streets) shall be minimized; where practicable, access shall be taken first from a lower classification street.
- G. The City may limit the number or location of connections to a street, or impose access restrictions where the roadway authority requires mitigation to alleviate safety or traffic operations concerns.
- H. The City may require a driveway to extend to one or more edges of a parcel and be designed to allow for future extension and inter-parcel circulation as adjacent properties develop. The City may also require the owner(s) of the subject site to record an access easement for future joint use of the approach and driveway as the adjacent property(ies) develop(s).

- I. Driveways shall accommodate all projected vehicular traffic on-site without vehicles stacking or backing up onto a street.
- J. Driveways shall be designed so that vehicle areas, including but not limited to drive-up and drive-through facilities and vehicle storage and service areas, do not obstruct any public right-of-way.
- K. Approaches and driveways shall not be wider than necessary to safely accommodate projected peak hour trips and turning movements, and shall be designed to minimize crossing distances for pedestrians.
- L. As it deems necessary for pedestrian safety, the City, in consultation with the roadway authority, may require traffic-calming features, such as speed tables, textured driveway surfaces, curb extensions, signage or traffic control devices, or other features, be installed on or in the vicinity of a site.
- M. Approaches and driveways shall be located and designed to allow for safe maneuvering in and around loading areas, while avoiding conflicts with pedestrians, parking, landscaping, and buildings.**
- N. Where a proposed driveway crosses a culvert or drainage ditch, the City may require the developer to install a culvert extending under and beyond the edges of the driveway on both sides of it, pursuant applicable Public Works standards.
- O. Except as otherwise required by the applicable roadway authority or waived by the City Engineer, temporary driveways providing access to a construction site or staging area shall be paved or graveled to prevent tracking of mud onto adjacent paved streets.
- P. Unless constrained by topography, natural resources, rail lines, freeways, existing or planned or approved development, or easements or covenants, driveways proposed as part of a residential or mixed-use development shall meet local street spacing standards and shall be constructed to align with existing or planned streets, if the driveway.
  - 1. Intersects with a public street that is controlled, or is to be controlled in the planning period, by a traffic signal;
  - 2. Intersects with an existing or planned arterial or collector street; or
  - 3. Would be an extension of an existing or planned local street, or of another major driveway.

***Applicant's Response: All driveway access, aisleways and driveway approaches will meet the City's standards for design and construction. Approaches and driveways are required to be designed and constructed to accommodate emergency vehicle apparatus.***

**Secondary or emergency access lanes may be improved to a minimum 12 feet with an all-weather surface as approved by the Fire District. Approaches and driveways will be located and designed to allow for safe maneuvering in and around loading areas, while avoiding conflicts with pedestrians, parking, landscaping, and buildings.**

**For additional information, refer to Section C – Exhibit Drawings, Sheet 04 – Site Plan - Overall (Preliminary) for compliance with these requirements.**

**Also, refer to Section D – Appendices, Appendix 22 – TVFR Land Use Review Application comments for additional information related to emergency access. As of the date of this submittal, no preliminary comments have been received from Tualatin Valley Fire and Rescue.**

- (.09) Minimum street intersection spacing standards.
- A. New streets shall intersect at existing street intersections so that centerlines are not offset. Where existing streets adjacent to a proposed development do not align properly, conditions shall be imposed on the development to provide for proper alignment.
  - B. Minimum intersection spacing standards are provided in Transportation System Plan Table 3-2.

**Applicant's Response: No new streets are proposed as part of the proposed Parkway Wood Business Park improvement project.**

- (.10) Exceptions and Adjustments. The City may approve adjustments to the spacing standards of subsections (.08) and (.09) above through a Class II process, or as a waiver per Section 4.118(.03)(A.), where an existing connection to a City street does not meet the standards of the roadway authority, the proposed development moves in the direction of code compliance, and mitigation measures alleviate all traffic operations and safety concerns. Mitigation measures may include consolidated access (removal of one access), joint use driveways (more than one property uses same access), directional limitations (e.g., one-way), turning restrictions (e.g., right in/out only), or other mitigation. [Section 4.177 amended by Ord. 719, 6/17/13]

**Applicant's Response: No exceptions or adjustments are being requested.**

## Mixed Solid Waste and Recycling

### Section Contains:

- **Section 4.179. Mixed Solid Waste and Recyclables Storage in New Multi-Unit Residential and Non-Residential Buildings**

### **Section 4.179. Mixed Solid Waste and Recyclables Storage in New Multi-Unit Residential and Non-Residential Buildings.**

- (.01) All site plans for multi-unit residential and non-residential buildings submitted to the Wilsonville Development Review Board for approval shall include adequate storage space for mixed solid waste and source separated recyclables.** [Amended by Ordinance No. 538, 2/21/02.]

***Applicant's Response:*** *In accordance with this section, the site plan for the proposed Parkway Wood Business Park improvement project will identify the storage area for the mixed solid waste and source separated recyclables.*

*Currently, there is a 30 yard trash compactor located on the building 60 loading dock as well as a 20 yard container located near the building 61 loading dock. The 20 yard is largely used by one of the tenants (i.e. 3Dsystems). The recycling is set up by the tenants through Republic Services based upon their needs. These are typically located on the loading docks.*

*For additional information, refer to Section C – Exhibit Drawings, Sheet 04 – Site Plan - Overall (Preliminary) for compliance with these requirements.*

- (.02) The floor area of an interior or exterior storage area shall be excluded from the calculation of building floor area for purposes of determining minimum storage requirements.

***Applicant's Response:*** *In accordance with this section, the floor area of an interior or exterior storage area has been excluded from the calculation of building floor area for purposes of determining minimum storage requirements.*

*For additional information, refer to Section C – Exhibit Drawings, Sheet 28 – Floor Plan for additional information.*

- (.03) The storage area requirement shall be based on the predominant use(s) of the building.** If a building has more than one of the uses listed herein and that use occupies 20 percent or less of the floor area of the building, the floor area occupied by that use shall be counted toward the floor area of the predominant use(s). If a building has more than one of the uses listed herein and that use occupies more than 20 percent of the floor area of the building, then the storage area requirement for the whole building shall be the sum of the requirement for the area of each use.



**Applicant's Response:** *The overall storage area requirement will be based on the office – flex space use.*

**(.04) Storage areas for multiple uses on a single site may be combined and shared.**

**Applicant's Response:** *Given the building has a number of tenants, the storage area will likely consist of a shared area and combined in to one location.*

(.05) The specific requirements are based on an assumed storage height of four feet for solid waste/recyclables. Vertical storage higher than four feet but no higher than seven feet may be used to accommodate the same volume of storage in a reduced floor space. Where vertical or stacked storage is proposed, the site plan shall include drawings to illustrate the layout of the storage area and dimensions for the containers.

**Applicant's Response:** *The specific requirements are based on an assumed storage height of four feet for solid waste/recyclables.*

(.06) The specific requirements for storage area are as follows:

- A. Multi-unit residential buildings containing five-ten units shall provide a minimum storage area of 50 square feet. Buildings containing more than ten residential units shall provide an additional five square feet per unit for each unit above ten.
- B. Non-residential buildings shall provide a minimum storage area of ten square feet, plus:**
  - 1. Office: Four square feet per 1,000 square feet gross floor area (GFA);
  - 2. Retail: Ten square feet per 1,000 square feet GFA;
  - 3. Wholesale / Warehouse / Manufacturing: Six square feet per 1,000 square feet GFA; and
  - 4. Other: Four square feet per 1,000 square feet GFA.**

**Applicant's Response:** *The current building contains 387,453 square feet. As previously mentioned, the use is intended to be Industrial Flex space. Based on a ratio four (4) square feet per 1,000 square feet, the existing building would create a demand for 1,550 square feet of storage for mixed solid waste collection.*

*The two (2) current collection areas satisfy the existing spacial demands. However, there is opportunity to expand the amount space attributed to this function, particularly in the western collection area.*

*Currently, there is a 30 yard trash compactor located on the building 60 loading dock as well as a 20 yard container located near the building 61 loading dock. The recycling is set up by the tenants*

*through Republic Services based upon their needs. The existing solid waste areas exceed the minimum square footage requirements identified above.*

- (.07) The applicant shall work with the City's franchised garbage hauler to ensure that site plans provide adequate access for the hauler's equipment and that storage area is adequate for the anticipated volumes, level of service and any other special circumstances which may result in the storage area exceeding its capacity.** The hauler shall notify the City by letter of their review of site plans and make recommendations for changes in those plans pursuant to the other provisions of this section.

**Applicant's Response: *In accordance with this section, the Owner/Applicant will work with the franchised garbage hauler to ensure that site plans provide adequate access for the hauler's equipment and that storage area is adequate for the anticipated volumes and level of service.***

*For additional information, refer to Section D – Appendices, Appendix 24 – Franchise Garbage Hauler Service Provider Letter/Memorandum for additional information. As of the date of this submittal, Republic Services has not provided any comments regarding solid waste or recycling. It is assumed that as part of the TI work, individual collection needs will be addressed.*

- (.08) Existing multi-unit residential and non-residential developments wishing to retrofit their structures to include storage areas for mixed solid waste and recycling may have their site plans reviewed and approved through the Class I Administrative Review process, according to the provisions of Section 4.035. Site plans for retrofitting existing developments must conform to all requirements of this Section, "Mixed Solid Waste and Recyclables Storage In New Multi-Unit Residential and Non-Residential Buildings," and 4.430, "Location, Design and Access Standards for Mixed Solid Waste and Recycling Areas," of the Wilsonville City Code. *[Added by Ordinance #426 - April 4, 1994]*

**Applicant's Response: *The existing development is already receiving service for mixed solid waste and recycling. Since no additional building spaces is being proposed, it is assumed that the existing storage area is sufficient to meet the demand in the future as new leases.***

*Currently, there is a 30 yard trash compactor located on the building 60 loading dock as well as a 20 yard container located near the building 61 loading dock.*

## Outdoor Lighting

### Section Contains:

- Section 4.199.10. Outdoor Lighting In General
- Section 4.199.20 Applicability.
- Section 4.199.30. Lighting Overlay Zones
- Section 4.199.40 Lighting Systems Standards for Approval.
- Section 4.199.50 Submittal Requirements.
- Section 4.199.60. Major Additions or Modifications to Pre-Existing Sites

### Section 4.199.10. Outdoor Lighting In General.

(.01) Purpose: The purpose of this Code is to provide regulations for outdoor lighting that will:

- A. Permit reasonable uses of outdoor lighting for nighttime safety, utility, security, productivity, enjoyment and commerce.
- B. Conserve energy and resources to the greatest extent possible.
- C. Minimize glare, particularly in and around public rights-of-way; and reduce visual discomfort and improve visual acuity over large areas by avoiding “light islands” and “spotlighting” that result in reduced visual perception in areas adjacent to either the source of the glare or the area illuminated by the glare.
- D. Minimize light trespass, so that each owner of property does not cause unreasonable light spillover to other property.
- E. Curtail the degradation of the nighttime environment and the night sky.
- F. Preserve the dark night sky for astronomy and enjoyment.
- G. Protect the natural environment, including wildlife, from the damaging effects of night lighting from human sources.

***Applicant’s Response:*** *The Owner/Applicant’s proposed lighting plan is consistent with the purpose of the lighting standard.*

(.02) Purpose Statement as Guidelines: Declaration of purpose statements are guidelines and not approval criteria in the application of WC Section 4.199.

***Applicant’s Response:*** *In accordance with this section, the Owner/Applicant acknowledge that purpose statements are guidelines and not approval criteria.*

### Section 4.199.20. Applicability.

(.01) This Ordinance is applicable to:

- A. Installation of new exterior lighting systems in public facility, commercial, industrial and multi-family housing projects with common areas.
- B. Major additions or modifications (as defined in this Section) to existing exterior lighting systems in public facility, commercial, industrial and multi-family housing projects with common areas.**

***Applicant's Response: The lighting regulations apply to this project because it modifies existing exterior lighting systems in an industrial facility with common areas.***

- (.02) Exemption. The following luminaires and lighting systems are EXEMPT from these requirements:
  - A. Interior lighting.
  - B. Internally illuminated signs.
  - C. Externally illuminated signs.
  - D. Temporary lighting for theatrical, television, and performance areas.
  - E. Lighting in swimming pools and other water features governed by Article 680 of the National Electrical Code.
  - F. Building Code required exit path lighting.
  - G. Lighting specifically for stairs and ramps.
  - H. Temporary and seasonal lighting provided that individual lamps are 10 watts or less.
  - I. Lighting required and/or regulated by the City (i.e. construction related activities), Federal Aviation Administration, U.S. Coast Guard or other Federal or State agency.
  - J. Single-family residential lighting.
  - K. Code Required Signs.
  - L. American flag.
  - M. Landscape lighting.
  - N. Lights approved by the City through an Administrative Review Temporary Use Permit process.
  - O. Public street lights.
  - P. ATM security lighting.

- Q. Those “Exceptions” listed in the “Exterior Lighting Power Allowance” provisions of the *Oregon Energy Efficiency Specialty Code*. [Added by Ord. 688, 11/15/10]

***Applicant’s Response: The proposed lighting is not exempt from regulation.***

**Section 4.199.30. Lighting Overlay Zones.**

- (.01) The designated Lighting Zone as indicated on the Lighting Overlay Zone Map for a commercial, industrial, multi-family or public facility parcel or project shall determine the limitations for lighting systems and fixtures as specified in this Ordinance.
- A. Property may contain more than one lighting zone depending on site conditions and natural resource characteristics.

***Applicant’s Response: Based on the City’s Lighting Overlay Zone map, the subject property is only located in one lighting zone, LZ 2.***

- (.02) The Lighting Zones shall be:
- A. ***LZ 1. This criterion is not applicable to this application since the subject property is located in the LZ 2 Lighting Overlay Zone.***
- B. ***LZ 2.*** Low-density suburban neighborhoods and suburban commercial districts, industrial parks and districts. This zone is intended to be the default condition for the majority of the City.
- C. ***LZ 3. This criterion is not applicable to this application since the subject property is located in the LZ 2 Lighting Overlay Zone.***
- D. ***LZ 4. This criterion is not applicable to this application since the subject property is located in the LZ 2 Lighting Overlay Zone.***

[Section 4.199.30(.02) amended by Ord. 688, 11/15/10]

***Applicant’s Response: Based on the City’s Lighting Overlay Zone map, the subject property is located in LZ-2 zone.***

***Refer to Section D – Appendices, Appendix 28 – Lighting Overlay Zone Map for additional information.***

- (.03) Modification of Lighting Zones.
- A. The City Council may modify the designated Lighting Zones of one or more parcels if the City Council finds that the original Lighting Zone was in error, a change in circumstances has occurred warranting the change since the designation was established or the purposes of this section are better served.

- B. The Development Review Board (DRB) may modify the designated Lighting Zones as part of the Stage II, Site Design Review Process if the DRB finds that the original Lighting Zone was in error, or a change in circumstances has occurred warranting the change since the designation was established or the purposes of this section are better served.
- C. This ordinance establishes a Lighting Overlay Zone Map. The Planning Division shall maintain the current Lighting Overlay Zone Map.

**Applicant's Response: No modifications to the Lighting Zone is being requested.**

**Section 4.199.40. Lighting Systems Standards for Approval.**

**(.01) Non-Residential Uses and Common Residential Areas.**

- A. All outdoor lighting shall comply with either the Prescriptive Option or the Performance Option below.

**Applicant's Response:**

***For purposes of this application, the Owner/Applicant will demonstrate compliance using the performance option.***

- B. Prescriptive Option. If the lighting is to comply with this Prescriptive Option, the installed lighting shall meet all of the following requirements according to the designated Lighting Zone.
  - 1. The maximum luminaire lamp wattage and shielding shall comply with Table 7.
  - 2. Except for those exemptions listed in Section 4.199.20(.02), the exterior lighting for the site shall comply with the *Oregon Energy Efficiency Specialty Code, Exterior Lighting*.
  - 3. The maximum pole or mounting height shall be consistent with Table 8.
  - 4. Each luminaire shall be set back from all property lines at least 3 times the mounting height of the luminaire:
    - a. Exception 1: If the subject property abuts a property with the same base and lighting zone, no setback from the common lot lines is required.
    - b. Exception 2: If the subject property abuts a property which is zoned (base and lighting) other than the subject parcel, the luminaire shall be setback three times the mounting height of the luminaire, measured from the abutting parcel's setback line. (Any variance or waiver to the abutting property's setback shall not be considered in the distance calculation).
    - c. Exception 3: If the luminaire is used for the purpose of street, parking lot or public utility easement illumination and is located less than 3 mounting heights

from the property line, the luminaire shall include a house side shield to protect adjoining property.

- d. Exception 4: If the subject property includes an exterior column, wall or abutment within 25 feet of the property line, a luminaire partly shielded or better and not exceeding 60 lamp watts may be mounted onto the exterior column, wall or abutment or under or within an overhang or canopy attached thereto.
- e. Exception 5: Lighting adjacent to SROZ areas shall be set back 3 times the mounting height of the luminaire, or shall employ a house side shield to protect the natural resource area.

**Applicant's Response: *The Owner/Applicant will use the Performance Option to ensure that the outdoor lighting complies with the City's code.***

**C. Performance Option. If the lighting is to comply with the Performance Option, the proposed lighting design shall be submitted by the applicant for approval by the City meeting all of the following:**

- 1. The weighted average percentage of direct up light lumens shall be less than the allowed amount per Table 9.**
- 2. The maximum light level at any property line shall be less than the values in Table 9, as evidenced by a complete photometric analysis including horizontal illuminance of the site and vertical illuminance on the plane facing the site up to the mounting height of the luminaire mounted highest above grade.** The Building Official or designee may accept a photometric test report, demonstration or sample, or other satisfactory confirmation that the luminaire meets the shielding requirements of Table 7. Luminaires shall not be mounted so as to permit aiming or use in any way other than the manner maintaining the shielding classification required herein:
  - a. Exception 1. If the property line abuts a public right-of-way, including a sidewalk or street, the analysis may be performed across the street at the adjacent property line to the right-of-way.
  - b. Exception 2. If, in the opinion of the Building Official or designee, compliance is impractical due to unique site circumstances such as lot size or shape, topography, or size or shape of building, which are circumstances not typical of the general conditions of the surrounding area. The Building Official may impose conditions of approval to avoid light trespass to the maximum extent possible and minimize any additional negative impacts resulting to abutting and adjacent parcels, as well as public rights-of-way, based on best lighting practices and available lighting technology.
- 3. The maximum pole or mounting height shall comply with Table 8.**

**Applicant's Response:** *Under the performance option, the project's outdoor lighting has a maximum of 5% of the direct uplight lumens and have a 0.2 foot-candles at the property line. The existing lighting and proposed lighting do not have or propose up-lighting in excess of these standards.*

*For additional information, refer to Section C – Exhibit 27 – Site Lighting Plan – Overall (Preliminary).*

- D. Curfew. All prescriptive or performance based exterior lighting systems shall be controlled by automatic device(s) or system(s) that:**
- 1. Initiate operation at dusk and either extinguish lighting one hour after close or at the curfew times according to Table 10; or**
  2. Reduce lighting intensity one hour after close or at the curfew time to not more than 50% of the requirements set forth in the *Oregon Energy Efficiency Specialty Code* unless waived by the DRB due to special circumstances; and
  3. Extinguish or reduce lighting consistent with 1. and 2. above on Holidays.

The following are exceptions to curfew:

- a. Exception 1: Building Code required lighting.
- b. Exception 2: Lighting for pedestrian ramps, steps and stairs.
- c. Exception 3: Businesses that operate continuously or periodically after curfew.  
*[Section 4.199.40 amended by Ord. 688, 11/15/10]*

**Applicant's Response:** *As required by this section, the exterior lighting systems will be controlled by an automatic system that will allow the lighting to be initiated and extinguished at selected times.*

- (.02) Special Permit for Specific Lighting Fixtures and Systems and When Exceeding Lighting Requirements. **The criterion is not applicable to this application since the proposed improvements will comply to the outdoor lighting requirements.**

#### **Section 4.199.50. Submittal Requirements.**

- (.01) Applicants shall submit the following information as part of DRB review or administrative review of new commercial, industrial, multi-family or public facility projects:
- A. A statement regarding which of the lighting methods will be utilized, prescriptive or performance, and a map depicting the lighting zone(s) for the property.**
  - B. A site lighting plan that clearly indicates intended lighting by type and location. For adjustable luminaires, the aiming angles or coordinates shall be shown.**



- C. For each luminaire type, drawings, cut sheets or other documents containing specifications for the intended lighting including but not limited to, luminaire description, mounting, mounting height, lamp type and manufacturer, lamp watts, ballast, optical system/distribution, and accessories such as shields.
- D. Calculations demonstrating compliance with *Oregon Energy Efficiency Specialty Code, Exterior Lighting*, as modified by Section 4.199.40(.01)(B.)(2.) [Amended by Ord. 688, 11/15/10]
- E. Lighting plans shall be coordinated with landscaping plans so that pole lights and trees are not placed in conflict with one another. The location of lights shall be shown on the landscape plan. Generally, pole lights should not be placed within one pole length of landscape and parking lot trees.
- F. Applicants shall identify the hours of lighting curfew.

***Applicant's Response:*** *The application submittal materials contains a site lighting plan that identifies the lighting by type and location. The location of the poles are also shown on the landscape plan to illustrate that there are not conflicts. Background documentation identifying the luminaire type, cut sheets or other documents including luminaire description, mounting, mounting height, lamp type and manufacturer, lamp watts, ballast, optical system/distribution, and accessories such as shields will be provided.*

***For additional information, refer to Section C – Exhibit 27 – Site Lighting Plan - Overall (Preliminary).***

- (.02) In addition to the above submittal requirements, Applicants using the Prescriptive Method shall submit the following information as part of the permit set plan review. ***This criterion is not applicable to this application since the Owner/Applicant will use the Performance Option to ensure that the outdoor lighting complies with the City's code.***
- (.03) In addition to the above submittal requirements, Applicants using the Performance Method shall submit the following information as part of the permit set plan review:
  - A. Site plan showing horizontal isocandle lines, or the output of a point-by-point computer calculation of the horizontal illumination of the site, showing property lines and light levels immediately off of the subject property.
  - B. For each side of the property, the output of a point-by-point vertical foot candle calculation showing illumination in the vertical plane at the property line from grade to at least 10 feet higher than the height of the tallest pole.
  - C. Lighting plans shall be prepared by a qualified licensed engineer.

**Applicant's Response:** *In accordance with this section, a site photometric point will be prepared by a licensed engineer. The plan will show the horizontal isocandle lines throughout the property and along the property lines. In addition, vertical foot-candle calculations will be illustrated.*

*For additional information, refer to Section C – Exhibit 27 – Site Lighting Plan – Overall (Preliminary).*

- (.04) In addition to the above applicable submittal requirements, Applicants for Special Permits shall submit the following to the DRB for review. ***This criterion is not applicable to this application since the Owner/Applicant is not requesting any special permits.***
- (.05) For all calculations, the following light loss factors shall be used unless an alternative is specifically approved by the City:

Metal halide	0.6
High pressure sodium	0.8
Compact fluorescent	0.7
Full size fluorescent	0.75
Incandescent	0.9
Halogen	0.95
Other	As approved

**Applicant's Response:** *As required, the Owner/Applicant will use the above light loss factors for use in the photometric calculations.*

**Section 4.199.60. Major Additions or Modifications to Pre-Existing Sites.**

**(.01) Major Additions.** ***If a major addition occurs on a property, all of the luminaires on the site shall comply with the requirements of this Section.*** For purposes of this sub-section, the following are considered to be major additions:

- A. Additions of 50 percent or more in terms of additional dwelling units, gross floor area, seating capacity, or parking spaces, either with a single addition or with cumulative additions after July 2, 2008.
- B. Modification or replacement of 50 percent or more of the outdoor lighting luminaries'** within a 5-year timeframe existing as of July 2, 2008.

**Table 7: Maximum Wattage And Required Shielding**

Lighting Zone	Fully Shielded	Shielded	Partly Shielded	Unshielded
LZ 1	70	20	13	Low voltage landscape lighting 50 watts or less
<b>LZ 2</b>	<b>100</b>	<b>35</b>	<b>39</b>	<b>Low voltage landscape lighting 50 watts or less</b>

LZ 3	250	100	70	Landscape and facade lighting 100 watts or less; ornamental lighting on private drives of 39 watts and less
LZ 4	450	150	150	Landscape and facade lighting 250 watts or less; ornamental lights on private drives and lanterns 70 watts or less; marquee lighting not employing medium based lamps

[Table 7 amended by Ord. 682, 9/9/10; Ord. 688, 11/15/10]

**Table 8: Maximum Lighting Mounting Height In Feet**

Lighting Zone	Lighting for private drives, driveways, parking, bus stops and other transit facilities	Lighting for walkways, bikeways, plazas and other pedestrian areas	All other lighting
LZ 0	20	8	4
LZ 1	25	12	4
<b>LZ 2</b>	<b>40</b>	<b>18</b>	<b>8</b>
LZ 3	40	18	16
LZ 4	Height limit to be determined by Special Use Permit Only		

Lighting mounted onto buildings or other structures shall not exceed a mounting height greater than 4 feet higher than the tallest part of the building or structure at the place where the lighting is installed, nor higher than 33.33 percent of the horizontal distance of the light from the nearest property line, whichever is less.

[Table amended by Ord. 682, 9/9/10]

**Table 9: Performance Method**

Lighting Zone	Maximum percentage of direct up light lumens	Maximum Light Level at Property Line	
		Horizontal plane at grade (foot candles - fc)	Vertical plane facing the site in question, from grade to mounting height of highest mounted luminaire (foot candles – fc)
LZ 0	0	0.01 fc	0.02 fc
LZ 1	1%	0.05 fc	0.1 fc
<b>LZ 2</b>	<b>5%</b>	<b>0.2 fc</b>	<b>0.4 fc</b>
LZ 3	10%	0.4 fc	0.8 fc

LZ 4	20%	0.8 fc	1.6 fc
------	-----	--------	--------

**Table 10: Curfew**

Lighting Zone	Curfew Time
LZ 0	8:00 PM (2000 hours)
LZ 1	
<b>LZ 2</b>	<b>10:00 PM (2200 hours)</b>
LZ 3	Midnight (2400 hours)
LZ 4	

*[Tables, above, renumbered by Ord. 688, 11/15/10]*

**Applicant's Response:** *Based on the thresholds identified in this section of the City's code, the proposed improvements would be likely result in the modification or replacement of a majority of the outdoor lighting luminaires on the current site.*

*The proposed exterior lighting/photometric plan will meet the maximum foot candles illumination levels at the property line of 0.2 as well as the 10:00pm lighting curfew.*

## Underground Utilities

### Underground Utilities

#### Section Contains:

- **Section 4.300**    **General**
- **Section 4.310**    **Exceptions**
- **Section 4.320**    **Requirements**

#### **Section 4.300.        General.**

- (.01)    The City Council deems it reasonable and necessary in order to accomplish the orderly and desirable development of land within the corporate limits of the City, to require the underground installation of utilities in all new developments.

**Applicant's Response:    *The project does not include new development.***

- (.02)    After the effective date of this Code, the approval of any development of land within the City will be upon the express condition that all new utility lines, including but not limited to those required for power, communication, street lighting, gas, cable television services and related facilities, shall be placed underground.

**Applicant's Response:    *The project does not include new utility lines. .***

- (.03)    The construction of underground utilities shall be subject to the City's Public Works Standards and shall meet applicable requirements for erosion control and other environmental protection.

**Applicant's Response:    *The Owner/Applicant understand that all undergrounding of utilities will comply with the City's Public Works standards.***

***Refer to Section C – Exhibit Drawings, Exhibit 06 – Utility Plan – Overall (Preliminary) for additional information.***

#### **Section 4.310        Exceptions.**

Section 4.300 of this Code shall not apply to surface-mounted transformers, surface-mounted connection boxes, wireless communication facilities, and meter cabinets and other appurtenances which are reasonably necessary to be placed above ground, or to temporary utility service facilities during construction, or to high capacity electric and communication feeder lines, or to utility transmission lines operating at 50,000 volts or more.

**Applicant's Response:    *The project does not include exempt utility features.***

#### **Section 4.320.        Requirements.**

- (.01) The developer or subdivider shall be responsible for and make all necessary arrangements with the serving utility to provide the underground services (including cost of rearranging any existing overhead facilities). All such underground facilities as described shall be constructed in compliance with the rules and regulations of the Public Utility Commission of the State of Oregon relating to the installation and safety of underground lines, plant, system, equipment and apparatus.

**Applicant's Response: No new services are proposed with the improvements that would require the undergrounding of overhead facilities. The site current has no overhead facilities on the property.**

- (.02) The location of the buried facilities shall conform to standards supplied to the subdivider by the City. The City also reserves the right to approve location of all surface-mounted transformers.

**Applicant's Response: In accordance with this section, the location of the buried facilities is required to conform to standards supplied by the City. The City also reserves the right to approve location of all surface-mounted transformers.**

- (.03) Interior easements (back lot lines) will only be used for storm or sanitary sewers, and front easements will be used for other utilities unless different locations are approved by the City Engineer. Easements satisfactory to the serving utilities shall be provided by the developer and shall be set forth on the plat.

**Applicant's Response: No interior easements are required.**

## Site Design Review

### Section Contains:

- **Section 4.400. Purpose**
- **Section 4.420. Jurisdiction and Powers of the Board**
- **Section 4.421. Criteria and Application of Design Standards**
- **Section 4.430. Location, Design and Access Standards for mixed Solid Waste and Recycling Areas**
- **Section 4.440. Procedure.**
- **Section 4.441. Effective Date of Decisions**
- **Section 4.442. Time Limit on Approval**
- **Section 4.443. Preliminary Consideration**
- **Section 4.450. Installation of Landscaping**

### Section 4.400 Purpose.

- (.01) Excessive uniformity, inappropriateness or poor design of the exterior appearance of structures and signs and the lack of proper attention to site development and landscaping in the business, commercial, industrial and certain residential areas of the City hinders the harmonious development of the City, impairs the desirability of residence, investment or occupation in the City, limits the opportunity to attain the optimum use in value and improvements, adversely affects the stability and value of property, produces degeneration of property in such areas and with attendant deterioration of conditions affecting the peace, health and welfare, and destroys a proper relationship between the taxable value of property and the cost of municipal services therefor.

***Applicant's Response: The Owner/Applicant understands the intent of the Site Design Review which is to create an appropriate design and exterior appearance of new for new development within the City.***

- (.02) The City Council declares that the purposes and objectives of site development requirements and the site design review procedure are to:
- A. Assure that Site Development Plans are designed in a manner that insures proper functioning of the site and maintains a high quality visual environment.

***Applicant's Response: The Owner/Applicant understands the intent of the Site Design Review which is to create an appropriate design and exterior appearance of new for new development within the City.***

- B. Encourage originality, flexibility and innovation in site planning and development, including the architecture, landscaping and graphic design of said development;**

***Applicant's Response: The Owner/Applicant understands the intent of the Site Design Review is to encourage originality, flexibility and innovation in site planning***

*and development, including the architecture, landscaping and graphic design of said development. The flexibility in design is being exercised through the placement of landscaped islands within the parking areas utilizing existing trees. The Owner/Applicant is also exercising flexibility and innovation in site planning through the placement of additional loading berth throughout the property. This will allow the maximum flexibility in interior space planning.*

- C. Discourage monotonous, drab, unsightly, dreary and inharmonious developments;

**Applicant's Response:** *No new buildings are being proposed. The improvements are limited to some minor exterior building enhancements and the expansion and reconfiguration of the circulation and surface parking areas. The improvements are intended to enhance and refresh the exterior of the existing building. This will included new window, doors and entrances.*

*Much of the existing structure consists of brick. The proposed improvements include the placement of black steel canopies at the entrances with cedar soffit and siding; installation of new windows/doors with dark bronze framing and green glazing; installation of new copper metal screening with a steel frame over the new west entry.*

- D. Conserve the City's natural beauty and visual character and charm by assuring that structures, signs and other improvements are properly related to their sites, and to surrounding sites and structures, with due regard to the aesthetic qualities of the natural terrain and landscaping, and that proper attention is given to exterior appearances of structures, signs and other improvements;**

**Applicant's Response:** *Again, no new buildings are being proposed. The improvements are limited to some minor exterior building enhancements and the expansion and reconfiguration of the circulation and surface parking areas. The new parking circulation will allow users and patrons to access the perimeter of the building. The reconfigured and expanded surface parking will provide safe and convenient parking in close proximity to all of the building entrances. The minor building improvements are intended to enhance and refresh the exterior of the existing building. This will included new window, doors and entrances.*

- E. Protect and enhance the City's appeal and thus support and stimulate business and industry and promote the desirability of investment and occupancy in business, commercial and industrial purposes;

**Applicant's Response:** *The proposed improvements are intended to increase the subject properties appeal to prospective tenants which will in turn will help stimulate the industrial flex space in the immediate vicinity.*



- F. Stabilize and improve property values and prevent blighted areas and, thus, increase tax revenues;

***Applicant's Response:*** *The financial investment in the property through building and site improvement is intended to increase the value of the subject property. Ultimately, the hope is that it will result in an increase in building occupancy. This in turn will increase tax revenues.*

- G. Insure that adequate public facilities are available to serve development as it occurs and that proper attention is given to site planning and development so as to not adversely impact the orderly, efficient and economic provision of public facilities and services.

***Applicant's Response:*** *The proposed improvements will not require any additional public facilities. It is assumed that existing public facilities will continue to be adequate to accommodate the existing development.*

- H. Achieve the beneficial influence of pleasant environments for living and working on behavioral patterns and, thus, decrease the cost of governmental services and reduce opportunities for crime through careful consideration of physical design and site layout under defensible space guidelines that clearly define all areas as either public, semi-private, or private, provide clear identity of structures and opportunities for easy surveillance of the site that maximize resident control of behavior -- particularly crime;

***Applicant's Response:*** *The proposed improvements have taken in consideration in the design and site layout the notion of defensible space. By increasing the access to all parts of the building, law enforcement and security can effectively and efficiently provide security and surveillance.*

- I. Foster civic pride and community spirit so as to improve the quality and quantity of citizen participation in local government and in community growth, change and improvements;

***Applicant's Response:*** *Through the implementation of the proposed site and building improvements, the new revitalized project can foster civic pride and community spirit.*

- J. Sustain the comfort, health, tranquility and contentment of residents and attract new residents by reason of the City's favorable environment and, thus, to promote and protect the peace, health and welfare of the City.

***Applicant's Response:*** *Similarly, through the implementation of the proposed improvements, it can attract new tenants. One of the product of attracting new business is the creation of new residents.*

#### **Section 4.420. Jurisdiction and Powers of the Board.**

- (.01) Application of Section. Except for single-family or two-family dwellings in any residential zoning district, and in the Village zone, row houses or apartments, no Building Permit shall

be issued for a new building or major exterior remodeling of an existing building, and no Sign Permit, except as permitted in Sections 4.156.02 and 4.156.05, shall be issued for the erection or construction of a sign relating to such new building or major remodeling, until the plans, drawings, sketches and other documents required for a Sign Permit application have been reviewed and approved by the Board. [Amended by Ord. No. 538, 2/21/02.] [Amended by Ord. No. 557, 9/5/03.] [Amended by Ord. No. 704, 6/18/12]

**Applicant's Response: In accordance with this section, no Building Permit will be issued for a major exterior remodeling of an existing building, and no Sign Permit will be issued until the plans, drawings, sketches and other documents required for a Sign Permit application have been reviewed and approved by Development Review Board.**

- (.02) Development in Accord with Plans. Construction, site development and landscaping shall be carried out in substantial accord with the plans, drawings, sketches and other documents approved by the Board, unless altered with Board approval. Nothing in this subsection shall be construed to prevent ordinary repair, maintenance and replacement of any part of the building or landscaping which does not involve a substantial change from the purpose of Section 4.400. If the Board objects to such proposed changes, they shall be subject to the procedures and requirements of the site design review process applicable to new proposals.

**Applicant's Response: The Owner/Applicant understands that the construction, site development and landscaping are required be carried out in substantial conformance with the plans, drawings, sketches and other documents approved by the Development Review Board.**

- (.03) Variances. The Board may authorize variances from the site development requirements, based upon the procedures, standards and criteria listed in Section 4.196. Variances shall be considered in conjunction with the site design review process.

**Applicant's Response: No variances are being requested before the Development Review Board.**

#### **Section 4.421. Criteria and Application of Design Standards.**

- (.01) The following standards shall be utilized by the Board in reviewing the plans, drawings, sketches and other documents required for Site Design Review. These standards are intended to provide a frame of reference for the applicant in the development of site and building plans as well as a method of review for the Board. These standards shall not be regarded as inflexible requirements. They are not intended to discourage creativity, invention and innovation. The specifications of one or more particular architectural styles is not included in these standards. (Even in the Boones Ferry Overlay Zone, a range of architectural styles will be encouraged.)

**A. Preservation of Landscape. The landscape shall be preserved in its natural state, insofar as practicable, by minimizing tree and soils removal, and any grade changes shall be in keeping with the general appearance of neighboring developed areas.**

**Applicant's Response:** *To the extent possible, the existing natural landscape is being preserved. This includes the forested vegetation along the periphery of the southern and eastern boundary as well as the open space area in the far northern portion of the subject property. For the most part development is limited the internal portions of the site immediately surrounding the building and within areas that currently contain impervious surfaces.*

- B. Relation of Proposed Buildings to Environment. Proposed structures shall be located and designed to assure harmony with the natural environment, including protection of steep slopes, vegetation and other naturally sensitive areas for wildlife habitat and shall provide proper buffering from less intensive uses in accordance with Sections 4.171 and 4.139 and 4.139.5. The achievement of such relationship may include the enclosure of space in conjunction with other existing buildings or other proposed buildings and the creation of focal points with respect to avenues of approach, street access or relationships to natural features such as vegetation or topography.

**Applicant's Response:** *One of the primary attributes associated with Parkway Woods Business Park is the location tucked in amongst the woods. The proposed improvements intend to build upon the setting by increasing visibility and access to the natural environment along the south side of the building. The proposed development will plant over 737 new trees on the property to promote the "woody" atmosphere.*

- C. **Drives, Parking and Circulation.** **With respect to vehicular and pedestrian circulation, including walkways, interior drives and parking, special attention shall be given to location and number of access points, general interior circulation, separation of pedestrian and vehicular traffic, and arrangement of parking areas that are safe and convenient and, insofar as practicable, do not detract from the design of proposed buildings and structures and the neighboring properties.**

**Applicant's Response:** *As previously mentioned, one of the primary purposes of the proposed improvements is to improve access and circulation to all portions of the existing building. This includes not only improving circulation, but also providing close and convenient surface parking in close proximity to the all of the major entrances.*

*The proposed development intends on reconfiguring the existing parking areas along the north, west and south sides as well as developing additional parking areas/vehicular circulation on the south and east side of the building. As part of this redevelopment, a continuous pedestrian pathway/walkways will be added to promote internal circulation along the south side of the building and through the site including the parking areas. Internal walkway between rows of parking are provided to improve connectivity between the parking fields and the major entries.*

*Because the shipping and receiving components are located along the north side of the building, a majority the pedestrian connectivity occurs in a north-south orientation. These areas terminate at the future right-of-way of SW Printer Parkway which will eventually contain a future multi-use pathway and serve as primary east-west route.*

- D. Surface Water Drainage. Special attention shall be given to proper site surface drainage so that removal of surface waters will not adversely affect neighboring properties of the public storm drainage system.**

**Applicant's Response:** *The reconfigured and expanded surface parking will contain water quality facilities (i.e. rain gardens) that in turn will connect with existing stormwater conveyance facilities. These are dispersed throughout the new parking areas and will help improve water quality through the subject property. The proposed improvements will not adversely affect neighboring properties of the public storm drainage system.*

- E. Utility Service. Any utility installations above ground shall be located so as to have a harmonious relation to neighboring properties and site. The proposed method of sanitary and storm sewage disposal from all buildings shall be indicated.

**Applicant's Response:** *To the extent possible, all utilities will be placed underground and will not be visible. Since no new buildings are proposed so the existing sanitary and storm sewer facilities will not be affected from any structures.*

- F. Advertising Features. In addition to the requirements of the City's sign regulations, the following criteria should be included: the size, location, design, color, texture, lighting and materials of all exterior signs and outdoor advertising structures or features shall not detract from the design of proposed buildings and structures and the surrounding properties.

**Applicant's Response:** *The Owner/Applicant is requesting approval of a Master Sign Plan to govern the size, location, design, color, texture, lighting and materials of all exterior signs.*

- G. Special Features. Exposed storage areas, exposed machinery installations, surface areas, truck loading areas, utility buildings and structures and similar accessory areas and structures shall be subject to such setbacks, screen plantings or other screening methods as shall be required to prevent their being incongruous with the existing or contemplated environment and its surrounding properties.** Standards for screening and buffering are contained in Section 4.176.

**Applicant's Response:** *To the extent possible, the existing loading areas for shipping, receiving and solid waste collections have been screened from the*

***adjacent roadways and surrounding properties by a high masonry wall. The same treatment, if required, will be provided for the new proposed loading area along the south side of the building.***

- (.02) The standards of review outlined in Sections (a) through (g) above shall also apply to all accessory buildings, structures, exterior signs and other site features, however related to the major buildings or structures.

***Applicant's Response: Again, the Owner/Applicant is requesting approval of a Master Sign Plan to govern the size, location, design, color, texture, lighting and materials of all exterior signs. The materials proposed for the signage will consist of metal (wood-look and satin finish steel) and be complementary to the existing buildings.***

***The proposed development does not include any accessory buildings or structures.***

- (.03) The Board shall also be guided by the purpose of Section 4.400, and such objectives shall serve as additional criteria and standards.

***Applicant's Response: In accordance with this section, the Owner/Applicant understand the objectives of Section 4.400 will serve as additional criteria and standards. Each of these are discussed below.***

- A. Assure that Site Development Plans are designed in a manner that insures proper functioning of the site and maintains a high quality visual environment.

***Applicant's Response: The Owner/Applicant understands the intent of the Site Design Review which is to create an appropriate design and exterior appearance of new for new development within the City.***

- B. Encourage originality, flexibility and innovation in site planning and development, including the architecture, landscaping and graphic design of said development;

***Applicant's Response: The Owner/Applicant understands the intent of the Site Design Review is to encourage originality, flexibility and innovation in site planning and development, including the architecture, landscaping and graphic design of said development. The flexibility in design is being exercised through the placement of landscaped islands within the parking areas utilizing existing trees. The Owner/Applicant is also exercising flexibility and innovation in site planning through the placement of additional loading berth throughout the property. This will allow the maximum flexibility in interior space planning.***

- C. Discourage monotonous, drab, unsightly, dreary and inharmonious developments;

***Applicant's Response: No new buildings are being proposed. The improvements are limited to some minor exterior building enhancements and the expansion and***

*reconfiguration of the circulation and surface parking areas. The improvements are intended to enhance and refresh the exterior of the existing building. This will included new window, doors and entrances.*

*More specifically, the proposed improvements include the placement of black steel canopies at the entrances with cedar soffit and siding; installation of new windows/doors with dark bronze framing and green glazing; installation of new copper metal screening with a steel frame over the new west entry.*

- D. Conserve the City's natural beauty and visual character and charm by assuring that structures, signs and other improvements are properly related to their sites, and to surrounding sites and structures, with due regard to the aesthetic qualities of the natural terrain and landscaping, and that proper attention is given to exterior appearances of structures, signs and other improvements;

**Applicant's Response:** *All of the proposed improvements (i.e. exterior building modification, plaza development, parking lot reconfiguration and expansion, and new signage system) are intended to improve the overall aesthetics of the property and to capitalize on the buildings setting within the woods.*

*The new parking circulation will allow users and patrons to access the entire perimeter of the building. The reconfigured and expanded surface parking will provide safe and convenient parking in close proximity to all of the building entrances. The minor building improvements are intended to enhance and refresh the exterior of the existing building. The signage will help with wayfinding by emergency services as well as the general public.*

- E. Protect and enhance the City's appeal and thus support and stimulate business and industry and promote the desirability of investment and occupancy in business, commercial and industrial purposes;

**Applicant's Response:** *The proposed improvements are intended to increase the subject properties appeal to prospective tenants which will in turn will help stimulate the industrial flex space in the immediate vicinity.*

- F. Stabilize and improve property values and prevent blighted areas and, thus, increase tax revenues;

**Applicant's Response:** *The financial investment in the property through building and site improvement is intended to increase the value of the subject property. Ultimately, the hope is that it will result in an increase in building occupancy. This in turn will increase tax revenues.*

- G. Insure that adequate public facilities are available to serve development as it occurs and that proper attention is given to site planning and development so as to not adversely impact the orderly, efficient and economic provision of public facilities and services.

***Applicant's Response:*** *The proposed improvements will not require any additional public facilities. It is assumed that existing public facilities will continue to be adequate to accommodate the existing development.*

- H. Achieve the beneficial influence of pleasant environments for living and working on behavioral patterns and, thus, decrease the cost of governmental services and reduce opportunities for crime through careful consideration of physical design and site layout under defensible space guidelines that clearly define all areas as either public, semi-private, or private, provide clear identity of structures and opportunities for easy surveillance of the site that maximize resident control of behavior -- particularly crime;

***Applicant's Response:*** *The proposed improvements have taken in consideration in the design and site layout the notion of defensible space. By increasing the access to all parts of the building, law enforcement and security can effectively and efficiently provide security and surveillance.*

- I. Foster civic pride and community spirit so as to improve the quality and quantity of citizen participation in local government and in community growth, change and improvements;

***Applicant's Response:*** *Through the implementation of the proposed site and building improvements, the new revitalized project can foster civic pride and community spirit.*

- J. Sustain the comfort, health, tranquility and contentment of residents and attract new residents by reason of the City's favorable environment and, thus, to promote and protect the peace, health and welfare of the City.

***Applicant's Response:*** *Similarly, through the implementation of the proposed improvements, it can attract new tenants. One of the product of attracting new business is the creation of new residents.*

- (.04) Conditional application. The Planning Director, Planning Commission, Development Review Board or City Council may, as a Condition of Approval for a zone change, subdivision, land partition, variance, conditional use, or other land use action, require conformance to the site development standards set forth in this Section.

***Applicant's Response:*** *It should be noted that the Planning Director and Development Review Board, as a Condition of Approval for land partition or other land use action, require conformance to the site development standards.*

- (.05) The Board may attach certain development or use conditions in granting an approval that are determined necessary to insure the proper and efficient functioning of the development, consistent with the intent of the Comprehensive Plan, allowed densities**

**and the requirements of this Code.** In making this determination of compliance and attaching conditions, the Board shall, however, consider the effects of this action on the availability and cost of needed housing. The provisions of this section shall not be used in such a manner that additional conditions either singularly or accumulatively have the effect of unnecessarily increasing the cost of housing or effectively excluding a needed housing type.

***Applicant's Response:*** *As part of review, the Owner/Applicant understands that the Development Review Board may attach certain development or use conditions in granting an approval that are determined necessary to insure the proper and efficient functioning of the development.*

**(.06) The Board or Planning Director may require that certain paints or colors of materials be used in approving applications.** Such requirements shall only be applied when site development or other land use applications are being reviewed by the City.

**A. Where the conditions of approval for a development permit specify that certain paints or colors of materials be used, the use of those paints or colors shall be binding upon the applicant.** No Certificate of Occupancy shall be granted until compliance with such conditions has been verified.

B. Subsequent changes to the color of a structure shall not be subject to City review unless the conditions of approval under which the original colors were set included a condition requiring a subsequent review before the colors could be changed.

***Applicant's Response:*** *The Owner/Applicant understand that Development Review Board or Planning Director may require that certain paints or colors of materials be used. Where the conditions of approval for a development permit specify that certain paints or colors of materials be used, the use of those paints or colors are be binding upon the Owner/Applicant.*

#### **Section 4.430. Location, Design and Access Standards for mixed Solid Waste and Recycling Areas**

(.01) The following locations, design and access standards for mixed solid waste and recycling storage areas shall be applicable to the requirements of Section 4.179 of the Wilsonville City Code.

***Applicant's Response:*** *The Owner/Applicant understands that this section of code is applies to the location, design and access standards for mixed solid waste and recycling storage areas.*

(.02) Location Standards:

A. To encourage its use, the storage area for source separated recyclables shall be co-located with the storage area for residual mixed solid waste.

**B. Indoor and outdoor storage areas shall comply with Uniform Building and Fire Code requirements.**



- C. Storage area space requirements can be satisfied with a single location or multiple locations and can combine with both interior and exterior locations.**
- D. Exterior storage areas can be located within interior side yard or rear yard areas. Minimum setback shall be three (3) feet. Exterior storage areas shall not be located within a required front yard setback, including double frontage lots.
- E. Exterior storage areas shall be located in central and visible locations on a site to enhance security for users.
- F. Exterior storage areas can be located in a parking area if the proposed use provides at least the minimum number of parking spaces required for the use after deducting the area used for storage. Storage areas shall be appropriately screened according to the provisions of Section 4.430 (.03), below.
- G. The storage area shall be accessible for collection vehicles and located so that the storage area will not obstruct pedestrian or vehicle traffic movement on the site or on public streets adjacent to the site.**

***Applicant's Response:*** *The existing solid waste and recycling areas are located in the loading areas on the north side of the building. These are of sufficient size to accommodate the existing users as well as the future tenants. The proposed new loading area may or may not be used for solid waste and recycling collection. This will depend upon the individual tenant requirements.*

***For compliance of these guideline, refer to Section C – Exhibit Drawings, Sheet 04 – Site Plan – Overall (Preliminary) for additional information.***

(.03) Design Standards.

- A. The dimensions of the storage area shall accommodate containers consistent with current methods of local collection.
- B. Storage containers shall meet Uniform Fire Code standards and be made of or covered with waterproof materials or situated in a covered area.
- C. Exterior storage areas shall be enclosed by a sight obscuring fence, wall or hedge at least six (6) feet in height. Gate openings for haulers shall be a minimum of ten (10) feet wide and shall be capable of being secured in a closed or open position.** In no case shall exterior storage areas be located in conflict with the vision clearance requirements of Section 4.177.
- D. Storage area(s) and containers shall be clearly labeled to indicate the type of materials accepted.**

**Applicant's Response:** *The project's storage areas meet the design standards. The two existing storage areas are partially enclosed by a masonry wall. Currently, there is a 30 yard trash compactor located on the building 60 loading dock as well as a 20 yard container located near the building 61 loading dock. The 20 yard is largely used by one of the tenants (i.e. 3Dsystems). The recycling is set up by the tenants through Republic Services based upon their needs. These are typically located on the loading docks.*

*For compliance of these guideline, refer to Section C – Exhibit Drawings, Sheet 04 – Site Plan – Overall (Preliminary) for additional information.*

**(.04) Access Standards.**

- A. Access to storage areas can be limited for security reasons. However, the storage area shall be accessible to users at convenient times of the day and to collect service personnel on the day and approximate time they are scheduled to provide collection service.
- B. Storage areas shall be designed to be easily accessible to collection trucks and equipment, considering paving, grade and vehicle access. A minimum of ten (10) feet horizontal clearance and eight feet of vertical clearance is required if the storage area is covered.**
- C. Storage areas shall be accessible to collection vehicles without requiring backing out of a driveway onto a public street. If only a single access point is available to the storage area, adequate turning radius shall be provided to allow collection vehicles to safely exit the site in a forward motion. *(Added by Ordinance #426, April 4, 1994.)*

**Applicant's Response:** *The existing storage areas have be designed to be easily accessible with solid waste collection trucks and equipment. Each area is accessible from a paved area with adequate width to allow for maneuvering.*

*For compliance of these guideline, refer to Section C – Exhibit Drawings, Sheet 04 – Site Plan – Overall (Preliminary) for additional information.*

**Section 4.440. Procedure.**

- (.01) Submission of Documents. A prospective applicant for a building or other permit who is subject to site design review shall submit to the Planning Department, in addition to the requirements of Section 4.035, the following:
  - A. A site plan**, drawn to scale, showing the proposed layout of all structures and other improvements including, where appropriate, driveways, pedestrian walks, landscaped areas, fences, walls, off-street parking and loading areas, and railroad tracks. The site

plan shall indicate the location of entrances and exits and direction of traffic flow into and out of off-street parking and loading areas, the location of each parking space and each loading berth and areas of turning and maneuvering vehicles. The site plan shall indicate how utility service and drainage are to be provided.

***Applicant's Response:*** ***A Site Plan showing the proposed layout of all improvements including, driveways, pedestrian walks, landscaped areas, fences/walls, off-street parking and loading areas is included in the application submission.***

***Refer to Section C – Exhibit Drawings, Sheet 04 – Site Plan – Overall (Preliminary) and Sheet 05 – Utility Plan Overall (Preliminary) for additional information.***

- B. A Landscape Plan**, drawn to scale, showing the location and design of landscaped areas, the variety and sizes of trees and plant materials to be planted on the site, the location and design of landscaped areas, the varieties, by scientific and common name, and sizes of trees and plant materials to be retained or planted on the site, other pertinent landscape features, and irrigation systems required to maintain trees and plant materials. An inventory, drawn at the same scale as the Site Plan, of existing trees of 4" caliper or more is required. However, when large areas of trees are proposed to be retained undisturbed, only a survey identifying the location and size of all perimeter trees in the mass is necessary.

***Applicant's Response:*** ***A Landscape Plan showing the location and design of landscaped areas, the variety and sizes of trees and plant materials to be planted on the site, the location and design of landscaped areas, the varieties, by scientific and common name, and sizes of trees and plant materials to be retained or planted on the site, other pertinent landscape features, and irrigation systems required to maintain trees and plant materials are included in the application submission.***

***Refer to Section C – Exhibit Drawings, Exhibit 16 – Landscape Plan - Overall (Preliminary), Exhibit 17 – Landscape Plan - Northwest Quadrant (Preliminary), Exhibit 18 – Landscape Plan - Northeast Quadrant (Preliminary), Exhibit 19 – Landscape Plan - Southwest Quadrant (Preliminary) and Exhibit 20 – Landscape Plans - Southeast Quadrant (Preliminary) for additional information.***

***Also refer to Sheet 20 – Plaza Detail Plan (Preliminary), Sheet 23 – Plant Material Legend (Preliminary) and Sheet 24 Landscape Details for additional information.***

- C. Architectural drawings or sketches**, drawn to scale, including floor plans, in sufficient detail to permit computation of yard requirements and showing all elevations of the proposed structures and other improvements as they will appear on completion of construction. Floor plans shall also be provided in sufficient detail to permit computation of yard requirements based on the relationship of indoor versus outdoor

living area, and to evaluate the floor plan's effect on the exterior design of the building through the placement and configuration of windows and doors.

***Applicant's Response:*** ***Architectural Drawings showing floor plans and elevations of the proposed improvements are included in the application submission.***

***Refer to Section C – Exhibit Drawings, Sheet 28 – Floor Plan (Preliminary) and Sheets 29, 30 and 31 – Building Elevations (Preliminary) for additional information.***

- D. A Color Board** displaying specifications as to type, color, and texture of exterior surfaces of proposed structures. Also, a phased development schedule if the development is constructed in stages.

***Applicant's Response:*** ***A Color Materials has been provided illustrating the type, color and texture of the materials to be used in the building modifications. Refer to Section D – Appendices, Appendix 25 – Color Materials Board for more information. A physical color/materials board will also be submitted to the City for review and approval.***

- E. A Sign Plan**, drawn to scale, showing the location, size, design, material, color and methods of illumination of all exterior signs.

***Applicant's Response:*** ***A Sign Plan showing the location, size, design, material, color and methods of illumination of all exterior signs is included in the application submission. This project includes a master sign plan.***

***Refer to Section D – Appendices, Appendix 30 – Master Sign Plan for more information.***

- F. The required application fee.**

***Applicant's Response:*** ***Based on the City's Planning Fee Schedule, the fee for Site Design Review is calculated by using a base fee of \$2,249 plus a total of \$1,607 per occupied building subject to review plus \$1,607 per 5 acres or portion thereof, of new site area. Based on this, the Site Design Review Fee is estimated at \$10,284. This is based on a total site disturbance area of 19.35 acres.***

- (.02) As soon as possible after the preparation of a staff report, a public hearing shall be scheduled before the Development Review Board. In accordance with the procedures set forth in Section 4.010(2) and 4.012, the Development Review Board shall review and approve, approve with conditions, or deny the proposed architectural, site development, landscaping or sign plans of the applicant. If the Board finds that additional information or time are necessary to render a decision, the matter may be continued to a date certain. The applicant shall be immediately notified in writing of any such continuation or delay together with the scheduled date of review.

**Applicant's Response:** *The Owner/Applicant understands that after the public hearing, the Development Review Board is required to review and approve, approve with conditions, or deny the proposed architectural, site development, landscaping or sign plans.*

**Section 4.441. Effective Date of Decisions.**

A decision of the Board shall become effective fourteen (14) calendar days after the date of the decision, unless the decision is appealed to, or called up by, the Council. If the decision of the Board is appealed to, or called up by, the City Council, the decision of the Council shall become effective immediately.

**Applicant's Response:** *The Owner/Applicant acknowledges that the decision of the Board will become effective fourteen (14) calendar days after the date of the decision, unless the decision is appealed.*

**Section 4.442. Time Limit on Approval.**

Site design review approval shall be void after two (2) years unless a building permit has been issued and substantial development pursuant thereto has taken place; or an extension is granted by motion of the Board.

**Applicant's Response:** *In accordance with this section of code, the Owner/Applicant understands that a site design review approval is valid for two (2) years unless a building permit has been issued or substantial development pursuant have occurred.*

**Section 4.443. Preliminary Consideration.**

An applicant may request preliminary consideration by the Board of general plans prior to seeking a building permit. When seeking preliminary consideration, the applicant shall submit a site plan showing the proposed structures, improvements and parking, together with a general description of the plans. The Board shall approve or reject all or part of the applicant's general plan within the normal time requirements of a formal application. Preliminary approval shall be deemed to be approval of the final plan to the extent that the final design contains the characteristics of the preliminary design.

**Applicant's Response:** *The Owner/Applicant is not requesting preliminary consideration.*

**Section 4.450. Installation of Landscaping.**

(.01) All landscaping required by this section and approved by the Board shall be installed prior to issuance of occupancy permits, unless security equal to one hundred and ten percent (110%) of the cost of the landscaping as determined by the Planning Director is filed with the City assuring such installation within six (6) months of occupancy. "Security" is cash, certified check, time certificates of deposit, assignment of a savings account or such other assurance of completion as shall meet with the approval of the City Attorney. In such cases

the developer shall also provide written authorization, to the satisfaction of the City Attorney, for the City or its designees to enter the property and complete the landscaping as approved. If the installation of the landscaping is not completed within the six-month period, or within an extension of time authorized by the Board, the security may be used by the City to complete the installation. Upon completion of the installation, any portion of the remaining security deposited with the City shall be returned to the applicant.

**Applicant's Response: *In accordance with this section, all landscaping required by this section and approved by the Board will be installed prior to issuance of occupancy permits, unless security equal to one hundred and ten percent (110%) of the cost of the landscaping is filed with the City.***

- (.02) Action by the City approving a proposed landscape plan shall be binding upon the applicant. Substitution of plant materials, irrigation systems, or other aspects of an approved landscape plan shall not be made without official action of the Planning Director or Development Review Board, as specified in this Code.

**Applicant's Response: *It is understood that the action by the City approving a proposed landscape plan will be binding upon the Owner/Applicant.***

- (.03) All landscaping shall be continually maintained, including necessary watering, weeding, pruning, and replacing, in a substantially similar manner as originally approved by the Board, unless altered with Board approval.

**Applicant's Response: *In accordance with this section, the Owner/Applicant acknowledge that all landscaping is required be continually maintained, including necessary watering, weeding, pruning, and replacing, in a substantially similar manner as originally approved by the Board.***

- (.04) If a property owner wishes to add landscaping for an existing development, in an effort to beautify the property, the Landscape Standards set forth in Section 4.176 shall not apply and no Plan approval or permit shall be required. If the owner wishes to modify or remove landscaping that has been accepted or approved through the City's development review process, that removal or modification must first be approved through the procedures of Section 4.010.

**Applicant's Response: *The Owner/Applicant understands that wishes to add landscaping for an existing development, the Landscape Standards do not apply and no Plan approval or permit will be required. However, if the owner wishes to modify or remove landscaping that has been accepted or approved through the City's development review process, that removal or modification must first be approved.***

## Tree Removal

### Tree Preservation and Protection

#### Section Contains:

- Section 4.600.10 Purpose and Declaration
- Section 4.600.20 Applicability of Subchapter
- Section 4.600.30 Tree Removal Permit Required
- Section 4.600.40 Exceptions
- Section 4.600.50 Application for Tree Removal Permit
- Section 4.610.00 Application Review Procedure
- Section 4.610.10 Standards for Tree Removal, Relocation Or Replacement
- Section 4.610.20 Type A Permit *(Not Applicable to this Application)*
- Section 4.610.30 Type B Permit *(Not Applicable to this Application)*
- Section 4.610.40 Type C Permit
- Section 4.610.50 Type D Permit *(Not Applicable to this Application)*
- Section 4.620.00 Tree Relocation, Mitigation, Or Replacement
- Section 4.620.10 Tree Protection During Construction
- Section 4.620.20 Maintenance and Protection Standards
- Section 4.630.00 Appeal
- Section 4.630.10 Display of Permit; Inspection
- Section 4.630.20 Variance for Hardship *(Not Applicable to this Application)*
- Section 4.630.30 Severability
- Section 4.640.00 Violation; Enforcement *(Not Applicable to this Application)*
- Section 4.640.10 Alternative Enforcement *(Not Applicable to this Application)*
- Section 4.640.20 Responsibility for Enforcement

#### Section 4.600. Purpose and Declaration

- (.01) Rapid growth, the spread of development, need for water and increasing demands upon natural resources have the effect of encroaching upon, despoiling, or eliminating many of the trees, other forms of vegetation, and natural resources and processes associated therewith which, if preserved and maintained in an undisturbed and natural condition, constitute important physical, aesthetic, recreational and economic assets to existing and future residents of the City of Wilsonville.

**Applicant's Response: *The Owner/Applicant understands the purpose of preserving and maintaining trees in an undisturbed and natural condition due to their important physical, aesthetic, recreational and economic value to existing and future residents of the City of Wilsonville.***

- (.02) Specifically, the City Council finds that:

- A. Woodland growth protects public health through the absorption of air pollutants and contamination, through the reduction of excessive noise and mental and physical damage related to noise pollution, and through its cooling effect in the summer months, and insulating effects in winter;**

- B. Woodlands provide for public safety through the prevention of erosion, siltation, and flooding; and**
- C. Trees make a positive contribution to water quality and water supply by absorbing rainfall, controlling surface water run-off, and filtering and assisting in ground water recharge; and**
- D. Trees and woodland growth are an essential component of the general welfare of the City of Wilsonville by producing play areas for children and natural beauty, recreation for all ages and an irreplaceable heritage for existing and future City residents.

***Applicant's Response: The Project is consistent with the purpose of this section.***

(.03) Therefore, the purposes of this subchapter are:

- A. To preserve Significant Resource Overlay Zone areas, recognizing that development can and will occur.**
- B. To provide for the protection, preservation, proper maintenance and use of trees and woodlands in order to protect natural habitat and prevent erosion.**
- C. To protect trees and other wooded areas for their economic contribution to local property values when preserved, and for their natural beauty and ecological or historical significance.
- D. To protect water quality, control surface water run-off, and protect ground water recharge.
- E. To reflect the public concern for these natural resources in the interest of health, safety and general welfare of Wilsonville residents.
- F. To encourage replanting where trees are removed.**

***Applicant's Response: The Project is consistent with the purpose of this section.***

#### **Section 4.600.20. Applicability of Subchapter**

- (.01) The provisions of this subchapter apply to the United States and the State of Oregon, and to their agencies and subdivisions, including the City of Wilsonville, and to the employees and agents thereof.
- (.02) By this subchapter, the City of Wilsonville regulates forest practices on all lands located within its urban growth boundary, as provided by ORS 527.722.
- (.03) The provisions of this subchapter apply to all land within the City limits, including property designated as a Significant Resource Overlay Zone or other areas or trees designated as protected by the Comprehensive Plan, City zoning map, or any other law or ordinance; except that any tree activities in the Willamette River Greenway that are regulated by the**



provisions of WC 4.500 - 4.514 and requiring a conditional use permit shall be reviewed by the DRB under the application and review procedures set forth for Tree Removal Permits.

**Applicant's Response:** *The project includes tree removal; therefore these criteria apply.*

#### **Section 4.600.30. Tree Removal Permit Required**

- (.01) Requirement Established. No person shall remove any tree without first obtaining a Tree Removal Permit (TRP) as required by this subchapter.

**Applicant's Response:** *This application, including the Type C Tree Removal Permits, is intended to satisfy the requirements of this section.*

- (.02) Tree Removal Permits will be reviewed according to the standards provided for in this subchapter, in addition to all other applicable requirements of Chapter 4.

**Applicant's Response:** *The Owner/Applicant acknowledges that the Tree Removal Permits will be reviewed for compliance with the standards identified throughout Chapter 4 of the City code.*

- (.03) Although tree activities in the Willamette River Greenway are governed by WC 4.500 - 4.514, the application materials required to apply for a conditional use shall be the same as those required for a Type B or C permit under this subchapter, along with any additional materials that may be required by the Planning Department. An application for a Tree Removal Permit under this section shall be reviewed by the Development Review Board.

**Applicant's Response:** *The project is not located in close proximity to the Willamette River Greenway.*

#### **Section 4.600.40. Exceptions**

- (.01) Exception from requirement. Notwithstanding the requirement of WC 4.600.30(1), the following activities are allowed without a Tree Removal Permit, unless otherwise prohibited:
- A. Agriculture, Commercial Tree Farm or Orchard. Tree removal or transplanting occurring during use of land for commercial purposes for agriculture, orchard(s), or tree farm(s), such as Christmas tree production.
  - B. Emergencies. Actions made necessary by an emergency, such as tornado, windstorm, flood, freeze, utility damage or other like disasters, in order to prevent imminent injury or damage to persons or property or restore order and it is impractical due to circumstances to apply for a permit.
    - 1. When an emergency has occurred, a Tree Removal Permit must be applied for within thirty (30) days following the emergency tree removal under the application procedures established in this subchapter.

2. In addition to complying with the permit application requirements of this subchapter, an applicant shall provide a photograph of any tree removed and a brief description of the conditions that necessitated emergency removal. Such photograph shall be supplied within seven days of application for a permit. Based on good cause shown arising out of the emergency, the Planning Director may waive any or all requirements of this section.
  3. Where a Type A Permit is granted for emergency tree removal, the permittee is encouraged to apply to the City Tree Fund for replanting assistance.
- C. City utility or road work in utility or road easements, in utility or road right-of-ways, or in public lands. However, any trees removed in the course of utility work shall be mitigated in accordance with the standards of this subchapter.
  - D. Nuisance abatement. The City is not required to apply for a Tree Removal Permit to undertake nuisance abatement as provided in WC 6.200 et seq. However, the owner of the property subject to nuisance abatement is subject to all the provisions of this subchapter in addition to the requirements of WC 6.200 et seq.
  - E. The removal of filbert trees is exempt from the requirements of this subchapter.
  - F. The Charbonneau District, including its golf course, is exempt from the requirements of WC 4.600.30(1) on the basis that by and through the current CC&R's of the Charbonneau Country Club, the homeowners' association complies with all requirements of WC 4.610.30(1)(C)(1). This exception has been based upon the Tree Maintenance and Protection Plan that has been submitted by the Charbonneau Country Club and approved by the Planning Director. Tree removal activities remain subject to all applicable standards of this subchapter. Unless authorized by the City, this exception does not include tree removal upon any public easements or public property within the district. In the event that the CC&R's are changed relative to the effect of the Tree Maintenance and Protection Plan, then the Planning Director shall review whether such effect is material, whether it can be mitigated, and if not, may disallow the exemption.

***Applicant's Response:*** *The project does not involve tree removal that would be exempt from these regulations.*

#### **Section 4.600.50. Application for Tree Removal Permit**

- (.01) Application for Permit. A person seeking to remove one or more trees shall apply to the Director for a Tree Removal Permit for a Type A, B, C, or D permit, depending on the applicable standards as provided in this subchapter.
  - A. An application for a tree removal permit that does not meet the requirements of Type A may be submitted as a Type B application.

***Applicant's Response:*** *A Type C Tree Removal application has been prepared and will be along with the other land use application materials.*

- (.02) Time of Application. Application for a Tree Removal Permit shall be made before removing or transplanting trees, except in emergency situations as provided in WC 4.600.40 (1)(B) above. Where the site is proposed for development necessitating site plan or plat review, application for a Tree Removal Permit shall be made as part of the site development application as specified in this subchapter.

**Applicant's Response:** *In accordance with this section, the application for a Tree Removal Permit is being submitted concurrently with and part of the Site Design Review application.*

- (.03) Fees. A person applying for a Tree Removal Permit shall pay a non-refundable application fee; as established by resolution of the City Council.

- A. By submission of an application, the applicant shall be deemed to have authorized City representatives to have access to applicant's property as may be needed to verify the information provided, to observe site conditions, and if a permit is granted, to verify that terms and conditions of the permit are followed.

**Applicant's Response:** *Based on the City's Planning Fee Schedule, the fee for Tree Permit (Type C) Tree Removal (26 or more trees) is \$329 plus \$11 per tree to be removed. The plan identifies the removal of 312 trees, however 10 of these are less than 6" DBH. Based on this, the Type C removal fee for the removal of 302 trees is estimated at \$3,651.*

*It should be noted that only 163 of 312 are healthy, non-nuisance trees.*

#### **Section 4.610.00. Application Review Procedure**

- (.01) The permit applicant shall provide complete information as required by this subchapter in order for the City to review the application.

**Applicant's Response:** *In accordance with this section, the Owner/Applicant has supplied all of the information necessary for the City to review the application.*

- (.02) Departmental Review. All applications for Tree Removal Permits must be deemed complete by the City Planning Department before being accepted for review. When all required information has been supplied, the Planning Department will verify whether the application is complete. Upon request of either the applicant or the City, the City may conduct a field inspection or review meeting. City departments involved in the review shall submit their report and recommendations to the Planning Director who shall forward them to the appropriate reviewing authority.

**Applicant's Response:** *The Owner/Applicant understands that the applications for Tree Removal Permit must be deemed complete by the City Planning Department before being accepted for review.*

(.03) Reviewing Authority.

- A. Type A or B. Where site plan review or plat approval by the Development Review Board is not required by City ordinance, the grant or denial of the Tree Removal Permit application shall be the responsibility of the Planning Director. The Planning Director has the authority to refer a Type B permit application to the DRB under the Class II administrative review procedures of this Chapter. The decision to grant or deny a permit shall be governed by the applicable review standards enumerated in WC 4.610.10

***Applicant's Response: The Owner/Applicant will not be pursuing a Type A or B Tree Removal Permit.***

- B. Type C. Where the site is proposed for development necessitating site plan review or plat approval by the Development Review Board, the Development Review Board shall be responsible for granting or denying the application for a Tree Removal Permit, and that decision may be subject to affirmance, reversal or modification by the City Council, if subsequently reviewed by the Council.

***Applicant's Response: The project's Type C permit will be reviewed by the Development Review Board.***

- C. Type D. Type D permit applications shall be subject to the standards and procedures of Class I administrative review and shall be reviewed for compliance with the Oregon Forest Practice Rules and Statutes. The Planning Director shall make the decision to grant or deny an application for a Type D permit.

***Applicant's Response: The Owner/Applicant will not be pursuing a Type D Tree Removal Permit.***

- D. Review period for complete applications. Type A permit applications shall be reviewed within 10 (ten) working days. Type B permit applications shall be reviewed by the Planning Director within thirty (30) calendar days, except that the DRB shall review any referred application within sixty (60) calendar days. Type C permit applications shall be reviewed within the time frame established by this Chapter. Type D permit applications shall be reviewed within 15 calendar days.

***Applicant's Response: In accordance with this section, a Type C permit application will be reviewed within the time frame established by this Chapter.***

- (.04) Notice. Before the granting of a Type C Tree Removal Permit, notice of the application shall be sent by regular mail to all owners within two hundred fifty feet (250') of the property where the trees are located as provided for in WC 4.010. The notice shall indicate where the application may be inspected and when a public hearing on the application will be held.

***Applicant's Response: The Owner/Applicant acknowledges that notice of the application will be sent by regular mail to all owners within two hundred fifty feet***

***(250') of the property where the trees are located before the granting of a Type C Tree Removal Permit.***

- (.05) Denial of Tree Removal Permit. Whenever an application for a Tree Removal Permit is denied, the permit applicant shall be notified, in writing, of the reasons for denial.

***Applicant's Response: The Owner/Applicant understands that a written notification will occur if the Tree Removal Permit is denied.***

- (.06) Grant of a Tree Removal Permit. Whenever an application for a Type B, C or D Tree Removal Permit is granted, the reviewing authority shall:

- A. Conditions. Attach to the granting of the permit any reasonable conditions considered necessary by the reviewing authority including, but not limited to, the recording of any plan or agreement approved under this subchapter, to ensure that the intent of this Chapter will be fulfilled and to minimize damage to, encroachment on or interference with natural resources and processes within wooded areas;
- B. Completion of Operations. Fix a reasonable time to complete tree removal operations; and
- C. Security. Require the Type C permit grantee to file with the City a cash or corporate surety bond or irrevocable bank letter of credit in an amount determined necessary by the City to ensure compliance with Tree Removal Permit conditions and this Chapter.
  - 1. This requirement may be waived by the Planning Director if the tree removal must be completed before a plat is recorded, and the applicant has complied with WC 4.264(1) of this Code.

***Applicant's Response: The Owner/Applicant acknowledges that conditions may be imposed as noted in this section.***

**Section 4.610.10. Standards for Tree Removal, Relocation or Replacement**

- (.01) Except where an application is exempt, or where otherwise noted, the following standards shall govern the review of an application for a Type A, B, C or D Tree Removal Permit:

- A. Standard for the Significant Resource Overlay Zone. The standard for tree removal in the Significant Resource Overlay Zone shall be that removal or transplanting of any tree is not inconsistent with the purposes of this Chapter.

***Applicant's Response: The Owner/Applicant acknowledges that conditions may be imposed as noted in this section.***

- B. Preservation and Conservation. No development application shall be denied solely because trees grow on the site. Nevertheless, tree preservation and conservation as a design principle shall be equal in concern and importance to other design principles.**

**Applicant's Response:** *The Owner/Applicant acknowledges that conditions may be imposed as noted in this section.*

- C. Developmental Alternatives. Preservation and conservation of wooded areas and trees shall be given careful consideration when there are feasible and reasonable location alternatives and design options on-site for proposed buildings, structures or other site improvements.

**Applicant's Response:** *The project involves minor building changes and modifications to the circulation and surface parking areas. In order to accommodate the changes, trees removal is required.*

*Through the design process, the Owner/Applicant explored a number of different alternative proposals for the placement of circulation routes and expanded surface parking areas. With each design evolution, a greater number of trees were preserved. Through this process over 155 additional trees were added to the preservation. Special attention was given to preserving as many of the Oregon White Oaks and Ponderosa Pines as possible. Due to the reconfiguration and expansion of the surface parking areas, 312 trees are proposed for removal. It is important to note that only 163 of these are in healthy condition.*

- D. Land Clearing. Where the proposed activity requires land clearing, the clearing shall be limited to designated street rights-of-way and areas necessary for the construction of buildings, structures or other site improvements.

**Applicant's Response:** *In order to accommodate the expansion of the circulation and surface parking areas, earthwork will be required which will require the clearing of the affected area which would include tree removal. This is necessary to facilitate the construction of the site improvements.*

*Refer to Section C – Exhibit Drawings, Exhibit 05 – Grading and Drainage Plan – Overall (Preliminary) for additional information.*

- E. Residential Development. Where the proposed activity involves residential development, residential units shall, to the extent reasonably feasible, be designed and constructed to blend into the natural setting of the landscape.

**Applicant's Response:** *No residential uses are being proposed.*

- F. Compliance With Statutes and Ordinances. The proposed activity shall comply with all applicable statutes and ordinances.

**Applicant's Response:** *The Owner/Applicant will comply with all applicable local, state and federal statutes and regulations.*

- G. Relocation or Replacement. The proposed activity shall include necessary provisions for tree relocation or replacement, in accordance with WC 4.620.00, and the protection of those trees that are not to be removed, in accordance with WC 4.620.10.**

**Applicant's Response: As part of the tree mitigation, the Owner/Application will be replacing the trees at a ratio of 1:1. All totaled, tree mitigation would require 302 trees to be replaced. The actual number of trees being proposed is 462.**

- H. Limitation. Tree removal or transplanting shall be limited to instances where the applicant has provided completed information as required by this Chapter and the reviewing authority determines that removal or transplanting is necessary based on the criteria of this subsection.
1. Necessary For Construction. Where the applicant has shown to the satisfaction of the reviewing authority that removal or transplanting is necessary for the construction of a building, structure or other site improvement, and that there is no feasible and reasonable location alternative or design option on-site for a proposed building, structure or other site improvement; or a tree is located too close to existing or proposed buildings or structures, or creates unsafe vision clearance.
  2. Disease, Damage, or Nuisance, or Hazard. Where the tree is diseased, damaged, or in danger of falling, or presents a hazard as defined in WC 6.208, or is a nuisance as defined in WC 6.200 et seq., or creates unsafe vision clearance as defined in this Code.
    - (a) As a condition of approval of Stage II development, filbert trees must be removed if they are no longer commercially grown or maintained.
  3. Interference. Where the tree interferes with the healthy growth of other trees, existing utility service or drainage, or utility work in a previously dedicated right-of-way, and it is not feasible to preserve the tree on site.
  4. Other. Where the applicant shows that tree removal or transplanting is reasonable under the circumstances.

**Applicant's Response: An Arborist Report has been prepared by Teragan and Associates. This document summarizes the trees and the reason for their removal. A significant number of the trees 149 are being removed because they are damaged, pose a hazard or are considered a nuisance tree. Again, 10 of these trees are less than 6" DBH.**

**Refer to Section D – Appendices, Appendix 17 – Arborist Report for more details.**

- I. Additional Standards for Type C Permits.

1. Tree survey. For all site development applications reviewed under the provisions of Chapter 4 Planning and Zoning, the developer shall provide a Tree Survey before site development as required by WC 4.610.40, and provide a Tree Maintenance and Protection plan, unless specifically exempted by the Planning Director or DRB, prior to initiating site development.
2. Platted Subdivisions. The recording of a final subdivision plat whose preliminary plat has been reviewed and approved after the effective date of Ordinance 464 by the City and that conforms with this subchapter shall include a Tree Survey and Maintenance and Protection Plan, as required by this subchapter, along with all other conditions of approval.
3. Utilities. The City Engineer shall cause utilities to be located and placed wherever reasonably possible to avoid adverse environmental consequences given the circumstances of existing locations, costs of placement and extensions, the public welfare, terrain, and preservation of natural resources. Mitigation and/or replacement of any removed trees shall be in accordance with the standards of this subchapter.

***Applicant's Response:*** *In accordance with this section no development application will be denied solely because trees grow on the site. In order to accommodate the proposed site improvements (i.e. improved circulation/access around the perimeter of the building; and provide safe and convenient parking in close proximity to the major building entrance), tree removal is required. The trees are being removed in order to facilitate construction activities of new drive aisles, parking stalls and pedestrian plaza. In other instances diseased, damaged, and/or nuisance are proposed for removal.*

*The Owner/Applicant have made a concerted effort to incorporate tree preservation in to the proposed circulation and surface parking improvements.*

*Of the 605 trees, 312 trees have been identified for removal. This includes 137 trees rated in good condition trees, 79 rated in fair condition, 86 rated in poor condition and 10 rated in very poor condition.*

*Listed in the table below is a breakdown of each tree proposed for removal:*

Tree Point Number	Common Name	Botanical Name	DBH	Condition	Comment
1128	red oak	<i>Quercus rubra</i>	16	fair	excessive pruning
1150	Norway maple	<i>Acer platanoides</i>	20	fair	multiple leaders with included bark, fused surface roots



2043	Norway maple	<i>Acer platanoides</i>	11	fair	stunted growth
2876	Norway maple	<i>Acer platanoides</i>	10	fair	low vigor
2881	Norway maple	<i>Acer platanoides</i>	10	fair	low vigor
3124	pin oak	<i>Quercus palustris</i>	13	fair	heavily pruned
3179	pin oak	<i>Quercus palustris</i>	12	fair	codominant at 20' with included bark, heavily pruned
3396	red oak	<i>Quercus rubra</i>	11	fair	heavily pruned
3509	pin oak	<i>Quercus palustris</i>	10	fair	one sided, significant pruning
<b>4005</b>	<b>Oregon white oak</b>	<b><i>Quercus garryana</i></b>	<b>36</b>	<b>fair</b>	<b>decay pocket at root crown behind lean</b>
4111	English hawthorn	<i>Crataegus monogyna</i>	7,5	fair	codominant at ground level, overtopped by adjacent trees
4152	Oregon ash	<i>Fraxinus latifolia</i>	17	fair	one sided, decay pocket in trunk, marginal trunk taper
4154	Oregon ash	<i>Fraxinus latifolia</i>	22	fair	previous failures with multiple leaders and decay at 18'
4156	Oregon ash	<i>Fraxinus latifolia</i>	17	fair	one sided, 40% live crown ratio
4158	English hawthorn	<i>Crataegus monogyna</i>	7,6,6,6,5	fair	one sided, overtopped by adjacent trees
<b>4160</b>	<b>Oregon white oak</b>	<b><i>Quercus garryana</i></b>	<b>29</b>	<b>fair</b>	<b>severe bend in trunk, leans north with upright stems on bent trunk</b>
4312	red oak	<i>Quercus rubra</i>	13	fair	top pruned out of tree
4370	pin oak	<i>Quercus palustris</i>	12	fair	top pruned out of tree
4481	red oak	<i>Quercus rubra</i>	30	fair	top pruned out of tree
4961	red oak	<i>Quercus rubra</i>	26	fair	significant past pruning
4963	red oak	<i>Quercus rubra</i>	26	fair	top pruned out of tree
5744	Norway maple	<i>Acer platanoides</i>	13	fair	one sided, codominant at 6'
5935	Norway maple	<i>Acer platanoides</i>	9	fair	significant pruning, sunscald on surface roots
7151	Norway maple	<i>Acer platanoides</i>	17	fair	sunscald on trunk and branches
<b>7305.1</b>	<b>Oregon white oak</b>	<b><i>Quercus garryana</i></b>	<b>12</b>	<b>fair</b>	<b>one sided, overtopped by adjacent trees, added to site map in approximate location by arborist</b>
<b>7522</b>	<b>ponderosa pine</b>	<b><i>Pinus ponderosa</i></b>	<b>31</b>	<b>fair</b>	<b>moderate branch tip dieback</b>
<b>7527</b>	<b>ponderosa pine</b>	<b><i>Pinus ponderosa</i></b>	<b>29</b>	<b>fair</b>	<b>one sided, lower branch dieback</b>
<b>7661</b>	<b>ponderosa pine</b>	<b><i>Pinus ponderosa</i></b>	<b>27</b>	<b>fair</b>	<b>moderate branch tip dieback</b>
<b>7671</b>	<b>ponderosa pine</b>	<b><i>Pinus ponderosa</i></b>	<b>23</b>	<b>fair</b>	<b>codominant at 10' with included bark, moderately thin crown</b>
<b>7685</b>	<b>ponderosa pine</b>	<b><i>Pinus ponderosa</i></b>	<b>19</b>	<b>fair</b>	<b>multiple leaders, moderately suppressed</b>
<b>7699</b>	<b>ponderosa pine</b>	<b><i>Pinus ponderosa</i></b>	<b>31</b>	<b>fair</b>	<b>moderately one sided, moderate branch tip dieback</b>
7913	pin oak	<i>Quercus palustris</i>	24	fair	decay pocket at 7' behind lean

7944	purpleleaf plum	<i>Prunus cerasifera</i>	21	fair	multiple leaders with included bark, suckers at base of trunk
<b>8007</b>	<b>ponderosa pine</b>	<b><i>Pinus ponderosa</i></b>	<b>20,11</b>	<b>fair</b>	<b>codominant at ground level, moderate branch tip dieback</b>
8051	purpleleaf plum	<i>Prunus cerasifera</i>	17	fair	multiple leaders with included bark, suckers at base of trunk
8055	purpleleaf plum	<i>Prunus cerasifera</i>	15	fair	multiple leaders with included bark, suckers at base of trunk
8056	purpleleaf plum	<i>Prunus cerasifera</i>	12	fair	multiple leaders with included bark, suckers at base of trunk
8071	purpleleaf plum	<i>Prunus cerasifera</i>	18	fair	multiple leaders with included bark, suckers at base of trunk
<b>8488</b>	<b>Oregon white oak</b>	<b><i>Quercus garryana</i></b>	<b>28</b>	<b>fair</b>	<b>25% live crown ratio, lower branch dieback and failures</b>
8489	sweet cherry	<i>Prunus avium</i>	6	fair	overtopped by adjacent trees
<b>8532</b>	<b>Oregon white oak</b>	<b><i>Quercus garryana</i></b>	<b>19</b>	<b>fair</b>	<b>one sided, marginal trunk taper</b>
<b>8533</b>	<b>Oregon white oak</b>	<b><i>Quercus garryana</i></b>	<b>20</b>	<b>fair</b>	<b>codominant at 1', 33% live crown ratio, poor trunk taper, large stem failure with decay at 3'</b>
8608	sweet cherry	<i>Prunus avium</i>	10	fair	overtopped by adjacent trees
<b>8904</b>	<b>Oregon white oak</b>	<b><i>Quercus garryana</i></b>	<b>20</b>	<b>fair</b>	<b>one sided from previous tree that was removed</b>
<b>8909</b>	<b>Oregon white oak</b>	<b><i>Quercus garryana</i></b>	<b>21</b>	<b>fair</b>	<b>one sided, marginal trunk taper</b>
8910	Douglas-fir	<i>Pseudotsuga menziesii</i>	9	fair	one sided, overtopped by adjacent trees
8919	Douglas-fir	<i>Pseudotsuga menziesii</i>	22	fair	one sided, overtopped by adjacent trees, previously lost top at 40'
<b>8920</b>	<b>ponderosa pine</b>	<b><i>Pinus ponderosa</i></b>	<b>33</b>	<b>fair</b>	<b>40% live crown ratio, scattered branch tip dieback</b>
8922	Douglas-fir	<i>Pseudotsuga menziesii</i>	17	fair	one sided, overtopped by adjacent trees, moderately thin crown
8925	sweet cherry	<i>Prunus avium</i>	14	fair	codominant at 30', 35% live crown ratio, decay at root crown
8927	Douglas-fir	<i>Pseudotsuga menziesii</i>	16	fair	one sided, overtopped by adjacent trees, marginal trunk taper
8928	Douglas-fir	<i>Pseudotsuga menziesii</i>	8	fair	overtopped by adjacent trees
8955	Douglas-fir	<i>Pseudotsuga menziesii</i>	5	fair	overtopped by adjacent trees, lost top at 7', sweep in lower trunk
8957.1	Oregon ash	<i>Fraxinus latifolia</i>	7	fair	one sided, overtopped by adjacent trees, added to site map in approximate location by arborist

9108	Oregon ash	<i>Fraxinus latifolia</i>	16	fair	one sided, decay pocket at lower trunk
<b>9153</b>	<b>Oregon white oak</b>	<b><i>Quercus garryana</i></b>	<b>18</b>	<b>fair</b>	<b>crown extension suppressed by adjacent trees, marginal trunk taper</b>
<b>9155</b>	<b>Oregon white oak</b>	<b><i>Quercus garryana</i></b>	<b>15</b>	<b>fair</b>	<b>one sided, 50% live crown ratio, marginal trunk taper</b>
9162	Oregon ash	<i>Fraxinus latifolia</i>	8	fair	overtopped by adjacent trees
9163	Douglas-fir	<i>Pseudotsuga menziesii</i>	6	fair	overtopped by adjacent trees
<b>9164</b>	<b>ponderosa pine</b>	<b><i>Pinus ponderosa</i></b>	<b>28</b>	<b>fair</b>	<b>one sided, moderately thin crown, codominant at 60'</b>
<b>9325</b>	<b>Oregon white oak</b>	<b><i>Quercus garryana</i></b>	<b>26</b>	<b>fair</b>	<b>overextended branches, moderately one sided</b>
9952	English hawthorn	<i>Crataegus monogyna</i>	5	fair	overtopped by adjacent trees
9976	Douglas-fir	<i>Pseudotsuga menziesii</i>	14	fair	15% live crown ratio, poor trunk taper
<b>10007</b>	<b>Oregon white oak</b>	<b><i>Quercus garryana</i></b>	<b>25</b>	<b>fair</b>	<b>moderately thin crown, 40% live crown ratio</b>
10009	Oregon ash	<i>Fraxinus latifolia</i>	8	fair	one sided, overtopped by adjacent trees
10012	Oregon ash	<i>Fraxinus latifolia</i>	10	fair	one sided, overtopped by adjacent trees
<b>10013</b>	<b>Oregon white oak</b>	<b><i>Quercus garryana</i></b>	<b>39</b>	<b>fair</b>	<b>moderately one sided, moderate branch dieback</b>
10151	Oregon ash	<i>Fraxinus latifolia</i>	20	fair	one sided, multiple leaders at 3', significant epicormic growth
10153	Oregon ash	<i>Fraxinus latifolia</i>	20	fair	codominant at 15' marginal trunk taper
10154	Oregon ash	<i>Fraxinus latifolia</i>	16	fair	poor trunk taper, 33% live crown ratio
10156	Oregon ash	<i>Fraxinus latifolia</i>	15	fair	one sided, overtopped by adjacent trees
<b>10158</b>	<b>Oregon white oak</b>	<b><i>Quercus garryana</i></b>	<b>12</b>	<b>fair</b>	<b>one sided, moderately suppressed</b>
10165	Oregon ash	<i>Fraxinus latifolia</i>	17	fair	moderately suppressed, multiple leaders with included bark
10170	sweet cherry	<i>Prunus avium</i>	8	fair	overtopped by adjacent trees, moderately suppressed
<b>10171</b>	<b>Oregon white oak</b>	<b><i>Quercus garryana</i></b>	<b>34</b>	<b>fair</b>	<b>one sided, significant lean, 35% live crown ratio</b>
10177	Oregon ash	<i>Fraxinus latifolia</i>	12	fair	overtopped by adjacent trees, moderately suppressed
10179	Oregon ash	<i>Fraxinus latifolia</i>	11	fair	one sided, codominant at 25'

10180	Oregon ash	<i>Fraxinus latifolia</i>	11	fair	poor trunk taper, 33% live crown ratio
10181	Oregon ash	<i>Fraxinus latifolia</i>	9	fair	one sided, damage at lower trunk
1126	red oak	<i>Quercus rubra</i>	28	good	multiple leaders with included bark
1127	Douglas-fir	<i>Pseudotsuga menziesii</i>	27	good	
1148	Norway maple	<i>Acer platanoides</i>	16	good	
1152	Oregon ash	<i>Fraxinus latifolia</i>	15	good	multiple leaders
1205	Douglas-fir	<i>Pseudotsuga menziesii</i>	26	good	moderately one sided
1264	Douglas-fir	<i>Pseudotsuga menziesii</i>	21	good	moderately one sided
1266	Douglas-fir	<i>Pseudotsuga menziesii</i>	12	good	one sided, moderately suppressed
1268	Douglas-fir	<i>Pseudotsuga menziesii</i>	36	good	codominant at 20'
1278	red oak	<i>Quercus rubra</i>	18	good	codominant at 10'
1554	Japanese black pine	<i>Pinus thunbergii</i>	15	good	
1556	Japanese black pine	<i>Pinus thunbergii</i>	19	good	codominant at 5'
1558	Japanese black pine	<i>Pinus thunbergii</i>	13,7	good	codominant at ground, multiple leaders in crown
1651	Norway maple	<i>Acer platanoides</i>	12	good	stunted growth, multiple leaders
1653	Norway maple	<i>Acer platanoides</i>	10	good	stunted growth, codominant at 6'
1655	Norway maple	<i>Acer platanoides</i>	13	good	excessive grown raising, damaged surface roots
1657	Norway maple	<i>Acer platanoides</i>	14	good	damaged surface roots
2093	red oak	<i>Quercus rubra</i>	20	good	codominant at 25' with included bark
2093.1	red oak	<i>Quercus rubra</i>	28	good	one sided, multiple leaders with included bark
2093.2	red oak	<i>Quercus rubra</i>	18	good	one sided
2093.3	red oak	<i>Quercus rubra</i>	25	good	
2093.4	red oak	<i>Quercus rubra</i>	27	good	multiple leaders with included bark
<b>2105</b>	<b>ponderosa pine</b>	<b><i>Pinus ponderosa</i></b>	<b>32</b>	<b>good</b>	
2159	red oak	<i>Quercus rubra</i>	18	good	
2315	Douglas-fir	<i>Pseudotsuga menziesii</i>	22	good	
2414	Austrian pine	<i>Pinus nigra</i>	16	good	codominant at 15'
2427	Norway maple	<i>Acer platanoides</i>	14	good	
2564	Norway maple	<i>Acer platanoides</i>	10	good	multiple leaders at 6'
<b>3794</b>	<b>ponderosa pine</b>	<b><i>Pinus ponderosa</i></b>	<b>24</b>	<b>good</b>	<b>codominant at 15'</b>

3796	ponderosa pine	<i>Pinus ponderosa</i>	17	good	one sided, codominant at 8' with included bark
3800	Japanese black pine	<i>Pinus thunbergii</i>	15	good	
3802	Japanese black pine	<i>Pinus thunbergii</i>	20	good	multiple leaders
3804	Japanese black pine	<i>Pinus thunbergii</i>	15	good	
3809	ponderosa pine	<i>Pinus ponderosa</i>	24	good	multiple leaders
3811	ponderosa pine	<i>Pinus ponderosa</i>	21	good	multiple leaders, moderately one sided
3813	ponderosa pine	<i>Pinus ponderosa</i>	21	good	multiple leaders
4001	Oregon ash	<i>Fraxinus latifolia</i>	15,7	good	codominant at ground level, one sided, overtopped by adjacent trees
4044	Norway maple	<i>Acer platanoides</i>	11	good	
4056	Norway maple	<i>Acer platanoides</i>	15	good	moderately one sided
4062	Norway maple	<i>Acer platanoides</i>	20	good	multiple leaders at 7' with included bark
4079	oak	<i>Quercus sp.</i>	16	good	multiple leaders with included bark
4087	Norway maple	<i>Acer platanoides</i>	15	good	
4094	sweet cherry	<i>Prunus avium</i>	21	good	upright competing branches
4107.1	Oregon white oak	<i>Quercus garryana</i>	18	good	one sided, added to site map in approximate location by arborist
4112	red oak	<i>Quercus rubra</i>	16	good	
4456	Norway maple	<i>Acer platanoides</i>	13	good	multiple leaders at 7' with included bark, sunscald on surface roots
4545	red oak	<i>Quercus rubra</i>	16	good	multiple leaders at 10'
4693	red oak	<i>Quercus rubra</i>	20	good	codominant at 15' with included bark
4723	red oak	<i>Quercus rubra</i>	15	good	multiple leaders at 15'
4840	Norway maple	<i>Acer platanoides</i>	16	good	
4855	Norway maple	<i>Acer platanoides</i>	21	good	multiple leaders at 8'
4859	Norway maple	<i>Acer platanoides</i>	12	good	codominant at 7'
4861	Norway maple	<i>Acer platanoides</i>	15	good	multiple leaders at 6'
5058	red oak	<i>Quercus rubra</i>	18	good	codominant at 10'
5315	red oak	<i>Quercus rubra</i>	27	good	40% live crown ratio
5417	red oak	<i>Quercus rubra</i>	18	good	moderately one sided
5544	red oak	<i>Quercus rubra</i>	26	good	codominant at 18'
5856	red oak	<i>Quercus rubra</i>	19	good	
5886	red oak	<i>Quercus rubra</i>	28	good	
5930	Norway maple	<i>Acer platanoides</i>	14	good	
6686	red oak	<i>Quercus rubra</i>	13	good	
7072	red oak	<i>Quercus rubra</i>	13	good	
7105	red oak	<i>Quercus rubra</i>	14	good	

7152	red oak	<i>Quercus rubra</i>	11	good	
<b>7260</b>	<b>ponderosa pine</b>	<b><i>Pinus ponderosa</i></b>	<b>32</b>	<b>good</b>	
<b>7300</b>	<b>Oregon white oak</b>	<b><i>Quercus garryana</i></b>	<b>17</b>	<b>good</b>	<b>one sided</b>
7301	English hawthorn	<i>Crataegus monogyna</i>	9	good	multiple leaders
7302	sweet cherry	<i>Prunus avium</i>	7	good	
<b>7304</b>	<b>Oregon white oak</b>	<b><i>Quercus garryana</i></b>	<b>17</b>	<b>good</b>	<b>one sided</b>
7510	English hawthorn	<i>Crataegus monogyna</i>	13	good	one sided, codominant at 3' with included bark
7513	red oak	<i>Quercus rubra</i>	19	good	
7515	Norway maple	<i>Acer platanoides</i>	15	good	multiple leaders at 7'
7573	sweet cherry	<i>Prunus avium</i>	7	good	one sided
<b>7575</b>	<b>Oregon white oak</b>	<b><i>Quercus garryana</i></b>	<b>17</b>	<b>good</b>	<b>moderately one sided</b>
7578	English hawthorn	<i>Crataegus monogyna</i>	12	good	codominant at 2' with included bark
7588	English hawthorn	<i>Crataegus monogyna</i>	10	good	one sided, multiple leaders with included bark
7589	sweet cherry	<i>Prunus avium</i>	7	good	one sided
7591	sweet cherry	<i>Prunus avium</i>	15	good	moderately one sided, partially uprooted but stable
7592	sweet cherry	<i>Prunus avium</i>	11	good	one sided
7670	Norway maple	<i>Acer platanoides</i>	17	good	multiple leaders with included bark
7910	pin oak	<i>Quercus palustris</i>	27	good	multiple leaders with included bark
7914	pin oak	<i>Quercus palustris</i>	20	good	multiple leaders with included bark
<b>7916</b>	<b>ponderosa pine</b>	<b><i>Pinus ponderosa</i></b>	<b>29</b>	<b>good</b>	<b>moderately one sided</b>
<b>7917</b>	<b>ponderosa pine</b>	<b><i>Pinus ponderosa</i></b>	<b>30</b>	<b>good</b>	<b>moderately one sided</b>
<b>8006</b>	<b>ponderosa pine</b>	<b><i>Pinus ponderosa</i></b>	<b>21</b>	<b>good</b>	<b>moderately one sided</b>
8093	Himalayan birch	<i>Betula utilis</i>	7	good	moderately one sided
8094	Himalayan birch	<i>Betula utilis</i>	12	good	
<b>8341</b>	<b>Oregon white oak</b>	<b><i>Quercus garryana</i></b>	<b>33</b>	<b>good</b>	<b>moderately one sided</b>
<b>8476</b>	<b>ponderosa pine</b>	<b><i>Pinus ponderosa</i></b>	<b>24</b>	<b>good</b>	
<b>8478</b>	<b>Oregon white oak</b>	<b><i>Quercus garryana</i></b>	<b>22</b>	<b>good</b>	<b>one sided</b>
<b>8479</b>	<b>Oregon white oak</b>	<b><i>Quercus garryana</i></b>	<b>23</b>	<b>good</b>	<b>one sided, history of lower branch failure</b>
<b>8486</b>	<b>Oregon white oak</b>	<b><i>Quercus garryana</i></b>	<b>33</b>	<b>good</b>	<b>multiple leaders, history of branch failure</b>
<b>8487</b>	<b>Oregon white oak</b>	<b><i>Quercus garryana</i></b>	<b>33</b>	<b>good</b>	<b>one sided, codominant at 3'</b>
8490	sweet cherry	<i>Prunus avium</i>	14,5	good	one sided, codominant at 1'

8498	Oregon white oak	<i>Quercus garryana</i>	26	good	one sided
8506	Douglas-fir	<i>Pseudotsuga menziesii</i>	31	good	one sided
8536	sweet cherry	<i>Prunus avium</i>	5	good	overtopped by adjacent trees
8799	Himalayan birch	<i>Betula utilis</i>	17	good	branches with high aspect ratios
8838	flowering cherry	<i>Prunus serrulata</i>	12	good	one sided
8839	flowering cherry	<i>Prunus serrulata</i>	23	good	pruned away from building
8880	flowering cherry	<i>Prunus serrulata</i>	15	good	overtopped by adjacent trees, one sided
8903	Douglas-fir	<i>Pseudotsuga menziesii</i>	8	good	overtopped by adjacent trees
8905	Douglas-fir	<i>Pseudotsuga menziesii</i>	10	good	overtopped by adjacent trees
8906	Oregon white oak	<i>Quercus garryana</i>	26	good	one sided from previous tree that was removed
8908	bigleaf maple	<i>Acer macrophyllum</i>	11	good	one sided, multiple leaders
8923	Douglas-fir	<i>Pseudotsuga menziesii</i>	14	good	one sided, overtopped by adjacent trees
8926	Douglas-fir	<i>Pseudotsuga menziesii</i>	18	good	wound at lower trunk
8931	sweet cherry	<i>Prunus avium</i>	7	good	overtopped by adjacent trees
8933	Oregon white oak	<i>Quercus garryana</i>	28	good	one sided, leans over building
8937	Douglas-fir	<i>Pseudotsuga menziesii</i>	16	good	codominant at 35'
8951	ponderosa pine	<i>Pinus ponderosa</i>	21	good	one sided
8953	Oregon white oak	<i>Quercus garryana</i>	25	good	one sided
8959	Oregon white oak	<i>Quercus garryana</i>	21	good	40% live crown ratio
8962	Douglas-fir	<i>Pseudotsuga menziesii</i>	22	good	moderately one sided
8963	Oregon white oak	<i>Quercus garryana</i>	23	good	one sided, codominant at 10'
8965	Douglas-fir	<i>Pseudotsuga menziesii</i>	11	good	one sided
9117	sweet cherry	<i>Prunus avium</i>	11	good	
9118	sweet cherry	<i>Prunus avium</i>	5	good	
9151	Oregon white oak	<i>Quercus garryana</i>	24	good	moderately one sided
9152	Oregon white oak	<i>Quercus garryana</i>	17	good	one sided
9154	Douglas-fir	<i>Pseudotsuga menziesii</i>	17	good	one sided, marginal trunk taper
9156	sweet cherry	<i>Prunus avium</i>	11	good	moderately one sided
9159	Oregon white oak	<i>Quercus garryana</i>	25	good	one sided

9160	Douglas-fir	<i>Pseudotsuga menziesii</i>	11	good	overtopped by adjacent trees
9210	red oak	<i>Quercus rubra</i>	25	good	one sided
9324	Oregon ash	<i>Fraxinus latifolia</i>	20	good	
9326	Oregon ash	<i>Fraxinus latifolia</i>	18	good	moderately one sided, overtopped by adjacent trees
<b>9327</b>	<b>Oregon white oak</b>	<b><i>Quercus garryana</i></b>	<b>38</b>	<b>good</b>	<b>large cavity at 30'</b>
<b>9345</b>	<b>Oregon white oak</b>	<b><i>Quercus garryana</i></b>	<b>35</b>	<b>good</b>	
10002	Oregon ash	<i>Fraxinus latifolia</i>	16,13	good	one sided, codominant at ground level
<b>10004</b>	<b>ponderosa pine</b>	<b><i>Pinus ponderosa</i></b>	<b>21</b>	<b>good</b>	<b>poor trunk taper</b>
<b>10010</b>	<b>ponderosa pine</b>	<b><i>Pinus ponderosa</i></b>	<b>25</b>	<b>good</b>	<b>one sided, 50% live crown ratio</b>
10152	Oregon ash	<i>Fraxinus latifolia</i>	14	good	multiple leaders at 3'
10152.1	sweet cherry	<i>Prunus avium</i>	6	good	
10155	Oregon ash	<i>Fraxinus latifolia</i>	10	good	poor trunk taper
<b>10157</b>	<b>ponderosa pine</b>	<b><i>Pinus ponderosa</i></b>	<b>30</b>	<b>good</b>	<b>marginal trunk taper, 40% live crown ratio</b>
<b>10161.1</b>	<b>Oregon white oak</b>	<b><i>Quercus garryana</i></b>	<b>27</b>	<b>good</b>	<b>one sided</b>
10167	Oregon ash	<i>Fraxinus latifolia</i>	20	good	one sided, multiple leaders
1203	Douglas-fir	<i>Pseudotsuga menziesii</i>	25	poor	codominant at 15' with included bark, history of top failures, dead top
1613	Japanese black pine	<i>Pinus thunbergii</i>	13	poor	low vigor, thin crown
2565	Norway maple	<i>Acer platanoides</i>	10	poor	low vigor
2660	red oak	<i>Quercus rubra</i>	15	poor	top pruned out of tree
2708	red oak	<i>Quercus rubra</i>	17	poor	excessive pruning, top pruned out of tree
2852	red oak	<i>Quercus rubra</i>	15	poor	top pruned out of tree
2862	red oak	<i>Quercus rubra</i>	15	poor	top pruned out of tree
3067	Norway maple	<i>Acer platanoides</i>	8	poor	low vigor, top pruned out of tree
3179.1	red oak	<i>Quercus rubra</i>	15	poor	heavily pruned, top pruned out of tree
3181	pin oak	<i>Quercus palustris</i>	9	poor	low vigor, heavily pruned
3348	red oak	<i>Quercus rubra</i>	16	poor	top pruned out of tree
3511	red oak	<i>Quercus rubra</i>	18	poor	top pruned out of tree
3561	red oak	<i>Quercus rubra</i>	9	poor	low vigor, excessive pruning
3798	Japanese black pine	<i>Pinus thunbergii</i>	12	poor	
4050	Oregon ash	<i>Fraxinus latifolia</i>	71	poor	stump sprout with decay at lower trunk
<b>4113</b>	<b>Oregon white oak</b>	<b><i>Quercus garryana</i></b>	<b>9</b>	<b>poor</b>	<b>suppressed</b>



4130	Oregon ash	<i>Fraxinus latifolia</i>	19,13,9	poor	multiple leaders at 2' with large decay pocket
4432	Norway maple	<i>Acer platanoides</i>	13	poor	low vigor
4450	Norway maple	<i>Acer platanoides</i>	11	poor	low vigor, significant pruning, sunscald on surface roots
5677	Norway maple	<i>Acer platanoides</i>	18	poor	sunscald on surface roots, top pruned out of tree
5746	Norway maple	<i>Acer platanoides</i>	14	poor	significant sunscald and decay at lower trunk
5887	Norway maple	<i>Acer platanoides</i>	11	poor	one sided, significant decay at lower trunk
5933	Norway maple	<i>Acer platanoides</i>	13	poor	sap rot, sloughing bark
6224	red oak	<i>Quercus rubra</i>	9	poor	excessive pruning
6377	red oak	<i>Quercus rubra</i>	11	poor	excessive pruning
6481	red oak	<i>Quercus rubra</i>	13	poor	lost top
<b>7305</b>	<b>Oregon white oak</b>	<b><i>Quercus garryana</i></b>	<b>9</b>	<b>poor</b>	<b>suppressed</b>
<b>7579</b>	<b>Oregon white oak</b>	<b><i>Quercus garryana</i></b>	<b>24</b>	<b>poor</b>	<b>extensive decay at lower trunk with standing water in decay pocket</b>
7590	sweet cherry	<i>Prunus avium</i>	9	poor	extensive sunscald at lower trunk
7674	Himalayan birch	<i>Betula utilis</i>	10	poor	suppressed
<b>8491</b>	<b>Oregon white oak</b>	<b><i>Quercus garryana</i></b>	<b>5</b>	<b>poor</b>	<b>suppressed</b>
<b>8493</b>	<b>Oregon white oak</b>	<b><i>Quercus garryana</i></b>	<b>9</b>	<b>poor</b>	<b>suppressed</b>
<b>8494</b>	<b>Oregon white oak</b>	<b><i>Quercus garryana</i></b>	<b>6</b>	<b>poor</b>	<b>suppressed</b>
8503	Scoulers willow	<i>Salix scouleriana</i>	5	poor	one sided, significant decay at root crown
8507	Douglas-fir	<i>Pseudotsuga menziesii</i>	12	poor	overtopped by adjacent trees, suppressed
<b>8515</b>	<b>Oregon white oak</b>	<b><i>Quercus garryana</i></b>	<b>13</b>	<b>poor</b>	<b>suppressed</b>
<b>8519</b>	<b>Oregon white oak</b>	<b><i>Quercus garryana</i></b>	<b>6</b>	<b>poor</b>	<b>suppressed</b>
<b>8520</b>	<b>Oregon white oak</b>	<b><i>Quercus garryana</i></b>	<b>15</b>	<b>poor</b>	<b>suppressed</b>
<b>8526</b>	<b>Oregon white oak</b>	<b><i>Quercus garryana</i></b>	<b>6</b>	<b>poor</b>	<b>suppressed</b>
<b>8528</b>	<b>Oregon white oak</b>	<b><i>Quercus garryana</i></b>	<b>9</b>	<b>poor</b>	<b>suppressed</b>
<b>8529</b>	<b>Oregon white oak</b>	<b><i>Quercus garryana</i></b>	<b>17</b>	<b>poor</b>	<b>suppressed, poor trunk taper</b>
<b>8913</b>	<b>Oregon white oak</b>	<b><i>Quercus garryana</i></b>	<b>10</b>	<b>poor</b>	<b>suppressed</b>
<b>8921</b>	<b>Oregon white oak</b>	<b><i>Quercus garryana</i></b>	<b>6</b>	<b>poor</b>	<b>overtopped by adjacent trees, suppressed</b>

8929	Scoulers willow	<i>Salix scouleriana</i>	15	poor	one sided, history of branch failure
8932	Scoulers willow	<i>Salix scouleriana</i>	14	poor	extensive decay in trunk
8934	English hawthorn	<i>Crataegus monogyna</i>	6	poor	suppressed
<b>8954</b>	<b>ponderosa pine</b>	<b><i>Pinus ponderosa</i></b>	<b>35</b>	<b>poor</b>	<b>significant branch dieback</b>
8957	Oregon white oak	<i>Quercus garryana</i>	9	poor	suppressed
8960	Oregon white oak	<i>Quercus garryana</i>	7	poor	suppressed
9109	sweet cherry	<i>Prunus avium</i>	5	poor	one sided, overtopped by adjacent trees, significant lean
9110	English hawthorn	<i>Crataegus monogyna</i>	6	poor	suppressed
9111	Oregon white oak	<i>Quercus garryana</i>	11,6	poor	suppressed, codominant at ground level, significant decay in 6" stem
9112	Oregon white oak	<i>Quercus garryana</i>	12	poor	suppressed
9113	Douglas-fir	<i>Pseudotsuga menziesii</i>	6	poor	suppressed
9157	Oregon white oak	<i>Quercus garryana</i>	10	poor	top failed at 8'
9158	Scoulers willow	<i>Salix scouleriana</i>	20	poor	history of branch failure, decay at lower trunk
9161	Oregon white oak	<i>Quercus garryana</i>	27	poor	moderately suppressed, moderate branch dieback
9322	Oregon white oak	<i>Quercus garryana</i>	25	poor	moderate branch dieback, 33% live crown ratio
9322.1	Oregon white oak	<i>Quercus garryana</i>	20	poor	suppressed
9675	Oregon white oak	<i>Quercus garryana</i>	9	poor	overtopped by adjacent trees, suppressed
9676	Oregon white oak	<i>Quercus garryana</i>	9	poor	overtopped by adjacent trees, suppressed
9681	Oregon white oak	<i>Quercus garryana</i>	8	poor	suppressed, significant decay at lower trunk
9685	Oregon white oak	<i>Quercus garryana</i>	23	poor	significant decay at lower and upper trunk
9800	ponderosa pine	<i>Pinus ponderosa</i>	30	poor	thin crown, 25% live crown ratio
9802	Oregon white oak	<i>Quercus garryana</i>	10	poor	lost top at 20'
9845	Oregon white oak	<i>Quercus garryana</i>	13	poor	overtopped by adjacent trees, suppressed
9947	Oregon white oak	<i>Quercus garryana</i>	9	poor	overtopped by adjacent trees, suppressed
9956	Oregon ash	<i>Fraxinus latifolia</i>	5	poor	suppressed
9963	Oregon white oak	<i>Quercus garryana</i>	20	poor	suppressed

9966	Oregon ash	<i>Fraxinus latifolia</i>	6	poor	suppressed, poor trunk taper
9973	bigleaf maple	<i>Acer macrophyllum</i>	6	poor	suppressed
<b>9974</b>	<b>Oregon white oak</b>	<b><i>Quercus garryana</i></b>	<b>20</b>	<b>poor</b>	<b>moderately suppressed, codominant at 20'</b>
9975	bigleaf maple	<i>Acer macrophyllum</i>	8	poor	suppressed
9985	Oregon ash	<i>Fraxinus latifolia</i>	7	poor	suppressed
<b>9988</b>	<b>Oregon white oak</b>	<b><i>Quercus garryana</i></b>	<b>11</b>	<b>poor</b>	<b>suppressed</b>
9989	bigleaf maple	<i>Acer macrophyllum</i>	10	poor	suppressed
9990	Oregon ash	<i>Fraxinus latifolia</i>	8	poor	suppressed
<b>9991</b>	<b>Oregon white oak</b>	<b><i>Quercus garryana</i></b>	<b>14</b>	<b>poor</b>	<b>suppressed</b>
9995	Oregon ash	<i>Fraxinus latifolia</i>	6	poor	suppressed
10005	Oregon ash	<i>Fraxinus latifolia</i>	7	poor	suppressed
10006	Oregon ash	<i>Fraxinus latifolia</i>	5	poor	suppressed
<b>10008</b>	<b>Oregon white oak</b>	<b><i>Quercus garryana</i></b>	<b>15</b>	<b>poor</b>	<b>suppressed, significant lean, trunk decay</b>
10160	Oregon ash	<i>Fraxinus latifolia</i>	5	poor	suppressed
<b>10164</b>	<b>Oregon white oak</b>	<b><i>Quercus garryana</i></b>	<b>8</b>	<b>poor</b>	<b>overtopped by adjacent trees, suppressed</b>
10168	Oregon ash	<i>Fraxinus latifolia</i>	10	poor	suppressed
10174	Oregon ash	<i>Fraxinus latifolia</i>	10	poor	one sided, suppressed, overextended branches
<b>7314</b>	<b>ponderosa pine</b>	<b><i>Pinus ponderosa</i></b>	<b>16</b>	<b>very poor</b>	<b>dying from top down</b>
7385	English hawthorn	<i>Crataegus monogyna</i>	8	very poor	suppressed, significant decay
7576	European birch	<i>Betula pendula</i>	10	very poor	dead top
7577	European birch	<i>Betula pendula</i>	9	very poor	dead
7598	black hawthorn	<i>Crataegus douglasii</i>	11	very poor	branch failures and internal decay
8149	flowering cherry	<i>Prunus serrulata</i>	9	very poor	extensive dieback and decay
8522	English hawthorn	<i>Crataegus monogyna</i>	6	very poor	dying
9474	Douglas-fir	<i>Pseudotsuga menziesii</i>	27	very poor	<i>Phaeolus schweinitzii</i> conk at base of trunk
9977	Douglas-fir	<i>Pseudotsuga menziesii</i>	11	very poor	dead
9978	bigleaf maple	<i>Acer macrophyllum</i>	21	very poor	20' snag
9997	Douglas-fir	<i>Pseudotsuga menziesii</i>	20	very poor	dead
10178	English hawthorn	<i>Crataegus monogyna</i>	8	very poor	overtopped by adjacent trees, suppressed

***Of the inventoried trees identified for removal, there are 71 Oregon White and 27 Ponderosa Pines. An individual breakdown of these two species based on condition is listed below:***

	<b><i>Good</i></b>	<b><i>Fair</i></b>	<b><i>Poor</i></b>	<b><i>Very Poor</i></b>
<i>Oregon White Oak</i>	21	15	35	0
<i>Ponderosa Pine</i>	15	9	2	1
<b><i>Total</i></b>	<b>36</b>	<b>24</b>	<b>37</b>	<b>1</b>

***Refer to Section C – Exhibit Drawings, Exhibits 12-15 – Tree Inventory Table (Preliminary) for additional information.***

***Also, refer to Section C – Exhibit Drawings, Exhibit 07 – Tree Protection and Removal Plan – Overall (Preliminary), Exhibit 08 – Tree Protection and Removal Plan - Northwest Quadrant (Preliminary), Exhibit 09 – Tree Protection and Removal Plan - Northeast Quadrant (Preliminary), Exhibit 10 – Tree Protection and Removal Plan - Southwest Quadrant (Preliminary) and Exhibit 11 – Tree Protection and Removal Plan - Southeast Quadrant (Preliminary) for additional information.***

- J. Exemption. Type D permit applications shall be exempt from review under standards D, E, H and I of this subsection.

***Applicant’s Response: The Owner/Applicant is pursuing a Type C Permit. Type D Tree Removal Permit are not applicable to this application.***

**Section 4.610.20. Type A Permit. *This section is not applicable to this application because the three removal permit is being review through a Type C Permit.***

**Section 4.610.30. Type B Permit. *This section is not applicable to this application because the three removal permit is being review through a Type C Permit.***

**Section 4.610.40. Type C Permit**

- (.01) Approval to remove any trees on property as part of a site development application may be granted in a Type C permit. A Type C permit application shall be reviewed by the standards of this subchapter and all applicable review criteria of Chapter 4. Application of the standards of this section shall not result in a reduction of square footage or loss of density, but may require an applicant to modify plans to allow for buildings of greater height. If an applicant proposes to remove trees and submits a landscaping plan as part of a site development application, an application for a Tree Removal Permit shall be included. The Tree Removal Permit application will be reviewed in the Stage II development review process, and any plan changes made that affect trees after Stage II review of a development application shall be subject to review by DRB. Where mitigation is required for tree

removal, such mitigation may be considered as part of the landscaping requirements as set forth in this Chapter. Tree removal shall not commence until approval of the required Stage II application and the expiration of the appeal period following that decision. If a decision approving a Type C permit is appealed, no trees shall be removed until the appeal has been settled.

***Applicant's Response: This application submittal includes a number of applications including a Stage II Planned Development modification and Site Plan Review. The request will be reviewed by the Development Review Board.***

- (.02) The applicant must provide ten copies of a Tree Maintenance and Protection Plan completed by an arborist that contains the following information:
- A. A plan, including a topographical survey bearing the stamp and signature of a qualified, registered professional containing all the following information:
    - 1. Property Dimensions. The shape and dimensions of the property, and the location of any existing and proposed structure or improvement.
    - 2. Tree survey. The survey must include:
      - a. An accurate drawing of the site based on accurate survey techniques at a minimum scale of one inch (1") equals one hundred feet (100') and which provides a) the location of all trees having six inches (6") or greater d.b.h. likely to be impacted, b) the spread of canopy of those trees, (c) the common and botanical name of those trees, and d) the approximate location and name of any other trees on the property.
      - b. A description of the health and condition of all trees likely to be impacted on the site property. In addition, for trees in a present or proposed public street or road right-of-way that are described as unhealthy, the description shall include recommended actions to restore such trees to full health. Trees proposed to remain, to be transplanted or to be removed shall be so designated. All trees to remain on the site are to be designated with metal tags that are to remain in place throughout the development. Those tags shall be numbered, with the numbers keyed to the tree survey map that is provided with the application.
      - c. Where a stand of twenty (20) or more contiguous trees exist on a site and the applicant does not propose to remove any of those trees, the required tree survey may be simplified to accurately show only the perimeter area of that stand of trees, including its drip line. Only those trees on the perimeter of the stand shall be tagged, as provided in "b," above.
      - d. **All Oregon white oaks, native yews, and any species listed by either the state or federal government as rare or endangered shall be shown in the tree survey.**

3. Tree Protection. A statement describing how trees intended to remain will be protected during development, and where protective barriers are necessary, that they will be erected before work starts. Barriers shall be sufficiently substantial to withstand nearby construction activities. Plastic tape or similar forms of markers do not constitute "barriers."
4. Easements and Setbacks. Location and dimension of existing and proposed easements, as well as all setbacks required by existing zoning requirements.
5. Grade Changes. Designation of grade changes proposed for the property that may impact trees.
6. Cost of Replacement. A cost estimate for the proposed tree replacement program with a detailed explanation including the number, size and species.
7. Tree Identification. A statement that all trees being retained will be identified by numbered metal tags, as specified in subsection "A," above in addition to clear identification on construction documents.

**Applicant's Response:** *An Arborist Report was prepared by Teragan is included with this application. This report identified tree protection measures and construction practices when working within the vicinity of trees identified for protection.*

*Refer to Section C – Exhibit Drawings, Exhibit 07 – Tree Protection and Removal Plan – Overall (Preliminary), Exhibit 08 – Tree Protection and Removal Plan - Northwest Quadrant (Preliminary), Exhibit 09 – Tree Protection and Removal Plan - Northeast Quadrant (Preliminary), Exhibit 10 – Tree Protection and Removal Plan - Southwest Quadrant (Preliminary) and Exhibit 11 – Tree Protection and Removal Plan - Southeast Quadrant (Preliminary) for additional information.*

*Refer to Section D – Appendices, Appendix 17 – Arborist Report for more details.*

**Section 4.610.50. Type D Permit.** *This section is not applicable to this application because the three removal permit is being review through a Type C Permit.*

**Section 4.620.00. Tree Relocation, Mitigation, or Replacement**

**(.01) Requirement Established.** *A Type B or C Tree Removal Permit grantee shall replace or relocate each removed tree having six (6) inches or greater d.b.h. within one year of removal.*

**Applicant's Response:** *In accordance with this section, the Owner/Applicant understands that each tree six (6) or greater that is removed will need to be replaced within one year of removal. The proposed replacement trees are illustrated on the proposed landscape plans.*

- (.02) Basis For Determining Replacement. The permit grantee shall replace removed trees on a basis of one (1) tree replanted for each tree removed. All replacement trees must measure two inches (2") or more in diameter.** Alternatively, the Planning Director or Development Review Board may require the permit grantee to replace removed trees on a per caliper inch basis, based on a finding that the large size of the trees being removed justifies an increase in the replacement trees required. Except, however, that the Planning Director or Development Review Board may allow the use of replacement Oregon white oaks and other uniquely valuable trees with a smaller diameter.

***Applicant's Response: Based on this section of code, the Owner/Applicant is required to replace the removed trees on a basis of one (1) tree replanted for each tree removed. The replacement trees must measure two inches (2") or more in diameter.***

***Based on the improvements, the proposed Tree Protection and Removal Plan identified the removal of 312 trees, 10 of which are less than 6" in size. The City's code requires the removed trees to be replaced on a basis of one (1) tree replanted for each tree removed. All totaled, 302 will be mitigated for.***

***The proposed landscape plans identify the planting of 302 mitigation trees, including of 5 Ponderosa Pines and 6 Oregon White Oaks.***

***Refer to Section C – Exhibit Drawings, Exhibit 16 – Landscape Plan - Overall (Preliminary), Exhibit 17 – Landscape Plan - Northwest Quadrant (Preliminary), Exhibit 18 – Landscape Plan - Northeast Quadrant (Preliminary), Exhibit 19 – Landscape Plan - Southwest Quadrant (Preliminary) and Exhibit 20 – Landscape Plans - Southeast Quadrant (Preliminary) for additional information.***

***It is also important to note the Owner/Applicant is evaluating the possibility of a future open space donation to the City as a future park and recreation area in the northeast portion of the property (north of Printer Parkway). This portion of the property contains over 30 acres of mixed upland and forested wetland.***

- (.03) Replacement Tree Requirements. A mitigation or replacement tree plan shall be reviewed by the City prior to planting and according to the standards of this subsection.**
- A. Replacement trees shall have shade potential or other characteristics comparable to the removed trees, shall be appropriately chosen for the site from an approved tree species list supplied by the City, and shall be state Department of Agriculture Nursery Grade No. 1 or better.**
  - B. Replacement trees must be staked, fertilized and mulched, and shall be guaranteed by the permit grantee or the grantee's successors-in-interest for two (2) years after the planting date.**

- C. A “guaranteed” tree that dies or becomes diseased during that time shall be replaced.
- D. Diversity of tree species shall be encouraged where trees will be replaced, and diversity of species shall also be maintained where essential to preserving a wooded area or habitat.

**Applicant’s Response: *In accordance with this section, the replacement trees will have shade potential or other characteristics comparable to the removed trees; will be appropriately chosen for the site from an approved tree species list supplied by the City, and will be state Department of Agriculture Nursery Grade No. 1 or better.***

***The proposed landscape plans identify the planting of 302 mitigation trees, including of 5 Ponderosa Pines and 6 Oregon White Oaks.***

- (.04) All trees to be planted shall consist of nursery stock that meets requirements of the American Association of Nurserymen (AAN) American Standards for Nursery Stock (ANSI Z60.1) for top grade.

**Applicant’s Response: *All trees to be planted will consist of nursery stock that meets requirements of the American Association of Nurserymen (AAN) American Standards for Nursery Stock (ANSI Z60.1) for top grade.***

- (.05) Replacement Tree Location.

- A. City Review Required. The City shall review tree relocation or replacement plans in order to provide optimum enhancement, preservation and protection of wooded areas. To the extent feasible and desirable, trees shall be relocated or replaced on-site and within the same general area as trees removed.

**Applicant’s Response: *In accordance with this section, the City will review tree relocation or replacement plans in order to provide optimum enhancement, preservation and protection of wooded areas.***

***The proposed mitigation plantings have been placed in two general areas to enhance the existing plant communities already present on site. The first is located in the northwest portion of the site and consists of two large planting areas. The second area is located in the southeaster portion of the site, east and south of the new parking areas. The intent is to supplement the existing plant communities on site in the general areas with the trees were being removed.***

- B. Relocation or Replacement Off-Site. When it is not feasible or desirable to relocate or replace trees on-site, relocation or replacement may be made at another location approved by the City.



**Applicant's Response: Given the size of the property, 302 mitigation trees will be planted on site.**

- (.06) City Tree Fund. Where it is not feasible to relocate or replace trees on site or at another approved location in the City, the Tree Removal Permit grantee shall pay into the City Tree Fund, which fund is hereby created, an amount of money approximately the value as defined by this subchapter, of the replacement trees that would otherwise be required by this subchapter. The City shall use the City Tree Fund for the purpose of producing, maintaining and preserving wooded areas and heritage trees, and for planting trees within the City.
- A. The City Tree Fund shall be used to offer trees at low cost on a first-come, first-serve basis to any Type A Permit grantee who requests a tree and registers with the City Tree Fund.
- B. In addition, and as funds allow, the City Tree Fund shall provide educational materials to assist with tree planting, mitigation, and relocation.

**Applicant's Response: The Owner/Applicant is not proposing to pay into the City's Tree Fund.**

- (.07) Exception. Tree replacement may not be required for applicants in circumstances where the Director determines that there is good cause to not so require. Good cause shall be based on a consideration of preservation of natural resources, including preservation of mature trees and diversity of ages of trees. Other criteria shall include consideration of terrain, difficulty of replacement and impact on adjacent property.

**Applicant's Response: The project does not require an exception to the tree replacement requirements.**

#### **Section 4.620.10. Tree Protection During Construction**

- (.01) Where tree protection is required by a condition of development under Chapter 4 or by a Tree Maintenance and Protection Plan approved under this subchapter, the following standards apply:
- A. All trees required to be protected must be clearly labeled as such.
- B. Placing Construction Materials Near Tree. No person may conduct any construction activity likely to be injurious to a tree designated to remain, including, but not limited to, placing solvents, building material, construction equipment, or depositing soil, or placing irrigated landscaping, within the drip line, unless a plan for such construction activity has been approved by the Planning Director or Development Review Board based upon the recommendations of an arborist.
- C. Attachments to Trees During Construction. Notwithstanding the requirement of WC 4.620.10(1)(A), no person shall attach any device or wire to any protected tree unless needed for tree protection.

- D. Protective Barrier. Before development, land clearing, filling or any land alteration for which a Tree Removal Permit is required, the developer shall erect and maintain suitable barriers as identified by an arborist to protect remaining trees. Protective barriers shall remain in place until the City authorizes their removal or issues a final certificate of occupancy, whichever occurs first. Barriers shall be sufficiently substantial to withstand nearby construction activities. Plastic tape or similar forms of markers do not constitute "barriers." The most appropriate and protective barrier shall be utilized. Barriers are required for all trees designated to remain, except in the following cases:
1. Right-of-Ways and Easements. Street right-of-way and utility easements may be cordoned by placing stakes a minimum of fifty (50) feet apart and tying ribbon, plastic tape, rope, etc., from stake to stake along the outside perimeters of areas to be cleared.
  2. Any property area separate from the construction or land clearing area onto which no equipment will venture may also be cordoned off as described in paragraph (D) of this subsection, or by other reasonable means as approved by the reviewing authority.

***Applicant's Response: In accordance with this section, the Owner/Applicant has submitted an Arborist Report. As part of this plan, no person will be allowed to conduct any construction activity that is likely to be injure to a tree designated to remain, including, but not limited to, placing solvents, building material, construction equipment, or depositing soil, or placing irrigated landscaping within the drip line.***

***In addition, before any land alteration for which a Tree Removal Permit is required, the developer will install and maintain tree protection fencing to protect remaining trees. Protective fencing is to remain in place until the City authorizes their removal or issues a final certificate of occupancy.***

***Refer to Section C – Exhibit Drawings, Exhibit 07 – Tree Protection and Removal Plan – Overall (Preliminary), Exhibit 08 – Tree Protection and Removal Plan - Northwest Quadrant (Preliminary), Exhibit 09 – Tree Protection and Removal Plan - Northeast Quadrant (Preliminary), Exhibit 10 – Tree Protection and Removal Plan - Southwest Quadrant (Preliminary) and Exhibit 11 – Tree Protection and Removal Plan - Southeast Quadrant (Preliminary) for additional information.***

#### **Section 4.620.20. Maintenance and Protection Standards**

- (.01) The following standards apply to all activities affecting trees, including, but not limited to, tree protection as required by a condition of approval on a site development application brought under this Chapter or as required by an approved Tree Maintenance and Protection Plan.

- A. Pruning activities shall be guided by the most recent version of the ANSI 300 Standards for Tree, Shrub, and Other Woody Plant Maintenance. Information on these standards shall be available upon request from the Planning Department.
- B. Topping is prohibited.
  - 1. Exception from this section may be granted under a Tree Removal Permit if necessary for utility work or public safety.

***Applicant's Response:*** *In accordance with this section, the Owner/Applicant understands that any pruning activities will be guided by the most recent version of the ANSI 300 Standards for Tree, Shrub, and Other Woody Plant Maintenance.*

**Section 4.630.00. Appeal**

- (.01) The City shall not issue a Tree Removal Permit until approval has been granted by either the Planning Director or the DRB. Any applicant denied a Type A or B permit may appeal the decision as provided for in review of Class I Development Applications, or Class II Development Applications, whichever is applicable. Decisions by the Planning Director may be appealed to the DRB as provided in WC 4.022. Decisions by the DRB may be appealed to the City Council as provided in WC 4.022.

***Applicant's Response:*** *The Owner/Applicant understands that the decision on a Type C Tree Removal Permit by the Development Review Board may be appealed to the City Council.*

- (.02) The City shall not issue a Tree Removal Permit approved by the Development Review Board until fifteen (15) calendar days have passed following the approval. The grant or denial of a Tree Removal Permit may be appealed to the City Council in the same manner as provided for in WC 4.022. An appeal must be filed in writing, within the fifteen (15) calendar day period following the decision being appealed. The timely filing of an appeal shall have the effect of suspending the issuance of a permit pending the outcome of the appeal. The City Council, upon review, may affirm, reverse or modify the decision rendered by the Development Review Board based upon the same standards of review specified for the DRB in the Wilsonville Code.

***Applicant's Response:*** *The Owner/Applicant acknowledges that City will not issue a Tree Removal Permit approved by the Development Review Board until fifteen (15) calendar days after the approval.*

**Section 4.630.10. Display Of Permit; Inspection**

The Tree Removal Permit grantee shall conspicuously display the permit on-site. The permit grantee shall display the permit continuously while trees are being removed or replaced or while activities authorized under the permit are performed. The permit grantee shall allow City representatives to enter and inspect the premises at any reasonable time, and failure to allow inspection shall constitute a violation of this subchapter.

***Applicant's Response:*** *In accordance with this section, the Owner/Applicant understands that the Tree Removal Permit is required to be display on-site. The permit will continue to be displayed while trees are being removed or replaced or while activities authorized under the permit are performed.*

**Section 4.630.20. Variance For Hardship** **This criterion is not applicable to this application because the Owner/Applicant is not requesting a variance for hardship.**

**Section 4.630.30. Severability** **This criterion is not applicable to this application**

**Section 4.640.00. Violation; Enforcement** **This criterion is not applicable to this application because the Owner/Applicant is not in violation or shown cause for enforcement.**

**Section 4.640.10. Alternative Enforcement** **This criterion is not applicable to this application because the Owner/Applicant is not in violation or shown cause for enforcement.**

**Section 4.640.20. Responsibility For Enforcement.** **This criterion is not applicable to this application**

## Definition of Terms

**Section Contains:**

- **Section 4.001 Definitions**

**Section 4.001 Definitions.**

**Applicants Response: *The definitions in this section have been incorporated into our response.***

## B.

### **Applicable City of Wilsonville Development Code Narrative**

---

The following information responds to applicable City of Wilsonville Development Code Standards for the **Parkway Woods Business Park Improvements** proposal. The applicant’s comments to individual sections are highlighted in bold for each applicable standard or regulation. Sections addressed include:

<b>Standards applying to all Planned Development Zones</b> .....	B-1
Section 4.118 - Standards applying to all Planned Development Zones .....	
<b>Planned Development Regulations</b> .....	B-11
Section 4.140 – Planned Development Regulations.....	
<b>Use and Zone Specific Standards and Regulations</b> .....	B-23
Section 4.117 - Standards Applying To Industrial Developments In Any Zone.....	
Section 4.135 - PDI- Planned Development Industrial Zone.....	
<b>Overlay Zones and Area Specific Regulations, including Design, Natural Resources, Interchange Area Traffic Management</b> .....	B-32
Section 4.139.00 - Significant Resource Overlay Zone (SROZ) Ordinance .....	
Section 4.139.01 - SROZ – Purpose.....	
Section 4.139.02 - Where These Regulations Apply .....	
Section 4.139.03 - Administration .....	
Section 4.139.04 - Uses and Activities Exempt from These Regulations.....	
Section 4.139.05 - Significant Resource Overlay Zone Map Verification.....	
Section 4.139.06 - Significant Resource Impact Report (SRIR) and Review Criteria.....	
Section 4.139.07 - Mitigation Standards .....	
Section 4.139.08 - Activities Requiring a Class I Administrative Review Process ( <i>Not Applicable to this Application</i> ) .....	
Section 4.139.09 - Activities Requiring a Class II Administrative Review Process .....	
Section 4.139.10 - Development Review Board (DRB) Process .....	
Section 4.139.11 - Special Provisions ( <i>Not Applicable to this Application</i> ).....	
<b>General Development Regulations and Standards</b> .....	B-58
Section 4.154 - On-site Pedestrian Access and Circulation .....	
Section 4.155 - General Regulations - Parking, Loading and Bicycle Parking .....	
Section 4.156 - Signage .....	
Section 4.171 - Protection of Natural Features and Other Resources .....	
Section 4.175 - Public Safety and Crime Prevention.....	
Section 4.176 - Landscaping, Screening, and Buffering .....	
Section 4.177 - Street Improvement Standards .....	
Section 4.179 - Mixed Solid Waste and Recyclables Storage in New Multi-Unit Residential and Non-Residential Buildings.....	
Section 4.199 - Outdoor Lighting .....	
<b>Underground Utilities</b> .....	B-146

Section 4.300 – General .....  
 Section 4.310 – Exceptions .....  
 Section 4.320 – Requirements.....

**Site Design Review (Detailed Review of Architecture, Landscaping, Signs and other Design Elements) .....B-148**

Section 4.400 - Purpose .....  
 Section 4.420 - Jurisdiction and Powers of the Board .....  
 Section 4.421 - Criteria and Application of Design Standards .....  
 Section 4.430 - Location, Design and Access Standards for Mixed Solid Waste and Recycling Areas .....  
 Section 4.440 - Procedure.....  
 Section 4.441 - Effective Date of Decisions .....  
 Section 4.442 - Time Limit on Approval .....  
 Section 4.443 - Preliminary Consideration .....  
 Section 4.450 - Installation of Landscaping .....

**Tree Removal .....B-164**

Section 4.600.10 - Purpose and Declaration.....  
 Section 4.600.20 - Applicability of Subchapter .....  
 Section 4.600.30 - Tree Removal Permit Required .....  
 Section 4.600.40 - Exceptions.....  
 Section 4.600.50 - Application for Tree Removal Permit .....  
 Section 4.610.00 - Application Review Procedure .....  
 Section 4.610.10 - Standards for Tree Removal, Relocation Or Replacement .....  
 Section 4.610.20 - Type A Permit *(Not Applicable to this Application)*.....  
 Section 4.610.30 - Type B Permit *(Not Applicable to this Application)*.....  
 Section 4.610.40 - Type C Permit.....  
 Section 4.610.50 - Type D Permit *(Not Applicable to this Application)* .....  
 Section 4.620.00 - Tree Relocation, Mitigation, Or Replacement .....  
 Section 4.620.10 - Tree Protection During Construction.....  
 Section 4.620.20 - Maintenance and Protection Standards .....  
 Section 4.630.00 – Appeal .....  
 Section 4.630.10 - Display of Permit; Inspection .....  
 Section 4.630.20 - Variance for Hardship *(Not Applicable to this Application)* .....  
 Section 4.630.30 – Severability *(Not Applicable to this Application)*.....  
 Section 4.640.00 - Violation; Enforcement*(Not Applicable to this Application)*.....  
 Section 4.640.10 - Alternative Enforcement *(Not Applicable to this Application)*.....  
 Section 4.640.20 - Responsibility for Enforcement *(Not Applicable to this Application)* .....

**Definition of Terms .....B-194**

Section 4.001 – Definition of Terms .....

**C.**  
**Exhibit Drawings**

---

The following exhibit drawings are intended to meet the plan and graphic requirements for the **Parkway Woods Business Park Improvements** proposal.

Exhibit drawings contained in this section include:

01	Cover Sheet.....
02	Existing Conditions Plan - <i>Overall</i> .....
03	On-Site Analysis Plan - <i>Overall</i> .....
04	Site Plan – <i>Overall (Preliminary)</i> .....
05	Grading and Drainage Plan - <i>Overall (Preliminary)</i> .....
06	Utility Plan - <i>Overall (Preliminary)</i> .....
07	Tree Protection and Removal Plan - <i>Overall (Preliminary)</i> .....
08	Tree Protection and Removal Plan - <i>Northwest Quadrant (Preliminary)</i> .....
09	Tree Protection and Removal Plan - <i>Northeast Quadrant (Preliminary)</i> .....
10	Tree Protection and Removal Plan - <i>Southwest Quadrant (Preliminary)</i> .....
11	Tree Protection and Removal Plan - <i>Southeast Quadrant (Preliminary)</i> .....
12	Tree Inventory Table ( <i>Preliminary</i> ).....
13	Tree Inventory Table ( <i>Preliminary</i> ).....
14	Tree Inventory Table ( <i>Preliminary</i> ).....
15	Tree Inventory Table ( <i>Preliminary</i> ).....
16	Landscape Plan - <i>Overall (Preliminary)</i> .....
17	Landscape Plan - <i>Northwest Quadrant (Preliminary)</i> .....
18	Landscape Plan - <i>Northeast Quadrant (Preliminary)</i> .....
19	Landscape Plan - <i>Southwest Quadrant (Preliminary)</i> .....
20	Landscape Plan - <i>Southeast Quadrant (Preliminary)</i> .....
21	Buffer Enhancement Plan ( <i>Preliminary</i> ) .....
22	Detailed Landscape Plans ( <i>Preliminary</i> ).....
23	Landscape Details and Plant Schedules ( <i>Preliminary</i> ) .....
24	Plaza Hardscape Plan ( <i>Preliminary</i> ) .....
25	Hardscape Details ( <i>Preliminary</i> ) .....
26	Tree Canopy Coverage Plan ( <i>Preliminary</i> ) .....
27	Site Lighting Plan ( <i>Preliminary (Overall)</i> ) .....
28	Floor Plan ( <i>Preliminary</i> ) .....
29	Building Elevations ( <i>Preliminary</i> ).....
30	Building Elevations ( <i>Preliminary</i> ).....
31	Building Elevations ( <i>Preliminary</i> ).....



**D.**  
**Appendices**

---

The following appendices provide background documentation and technical data that support the **Parkway Woods Business Park Improvements** proposal. These include following:

Appendix 1	Partition Plat – 2018-109 ( <i>OTAK, Inc.</i> ) .....
Appendix 2	TRIO ( <i>Chicago Title Company</i> ) .....
Appendix 3	Assessors Tax Map ( <i>Washington County</i> ) .....
Appendix 4	Comprehensive Plan Map ( <i>City of Wilsonville</i> ) .....
Appendix 5	Zoning Map ( <i>City of Wilsonville</i> ) .....
Appendix 6	Pre-Application Submittal Request .....
Appendix 7	Pre-Application Summary Notes ( <i>City of Wilsonville</i> ) .....
Appendix 8	Staff Report/Notice of Decision for Prior Land Use Approvals ( <i>City of Wilsonville</i> ) .....
Appendix 9	Land Donation Resolution Number 2731 ( <i>City of Wilsonville</i> ) .....
Appendix 10	Local Wetlands and Riparian Corridor Inventory ( <i>City of Wilsonville</i> ) .....
Appendix 11	Significant Resource Overlay Zone (SROZ) Map ( <i>City of Wilsonville</i> ) .....
Appendix 12	Wetland Delineation Report ( <i>Pacific Habitats, Inc.</i> ) .....
Appendix 13	Significant Resource Impact Report (SRIR) ( <i>Pacific Habitats, Inc.</i> ) .....
Appendix 14	Joint Cut/Fill Permit ( <i>Pacific Habitats, Inc.</i> ) .....
Appendix 15	Approved Jurisdictional Determination ( <i>US Corp of Engineers</i> ) .....
Appendix 16	Tree Inventory ( <i>Teragan &amp; Associates, LLC</i> ) .....
Appendix 17	Arborist Report ( <i>Teragan &amp; Associates, LLC</i> ) .....
Appendix 18	Soils Map ( <i>NRCS</i> ) .....
Appendix 19	Geotechnical Report ( <i>GeoDesign, Inc.</i> ) .....
Appendix 20	Storm Water Drainage Report ( <i>Atwell, LLC</i> ) .....
Appendix 21	Traffic Impact Study Waiver .....
Appendix 22	TVFR Land Use Review Application ( <i>Tualatin Valley Fire &amp; Rescue</i> ) .....
Appendix 23	WB-67 Semi-Trailer Truck Vehicle Tracking Exhibit ( <i>Atwell, LLC</i> ) .....
Appendix 24	Franchise Garbage Hauler Service Provider Letter/Memorandum ( <i>Republic Services</i> ) .....
Appendix 25	Color Materials Board ( <i>Mildren Design Group, PC</i> ) .....
Appendix 26	Outdoor Furnishings Manufacturers Product Sheet (picnic tables, benches, bike racks, trash receptacles and shelter) .....
Appendix 27	Entry Renderings .....
Appendix 28	Lighting Overlay Zone Map ( <i>City of Wilsonville</i> ) .....
Appendix 29	Lighting Manufacturers Product Sheets (poles and fixtures) ( <i>Harry L Stearns</i> ) .....
Appendix 30	Master Sign Plan ( <i>FINE</i> ) .....
Appendix 31	Real Estate Broker Opinion Letter ( <i>Kidder Mathews</i> ) .....
Appendix 32	Entry Plaza Rendering .....

**Section A - Introduction**

1. Development Team Members .....	A-1
2. Property and Zoning Summary .....	A-3
3. Background Information .....	A-3
4. Project Summary.....	A-3
5. Key Issues.....	A-5
6. Prior Land Use Approvals.....	A-6
7. Land Use Reviews Requested .....	A-7
8. Application Fee Calculations .....	A-7

**Section B - Applicable Development Code Narrative**

<b>Standards applying to all Planned Development Zones</b> .....	B-1
Section 4.118 - Standards applying to all Planned Development Zones .....	

<b>Planned Development Regulations</b> .....	B-11
Section 4.140 – Planned Development Regulations.....	

<b>Use and Zone Specific Standards and Regulations</b> .....	B-23
Section 4.117 - Standards Applying To Industrial Developments In Any Zone.....	
Section 4.135 - PDI- Planned Development Industrial Zone.....	

<b>Overlay Zones and Area Specific Regulations, including Design, Natural Resources, Interchange Area Traffic Management</b> .....	B-32
--	------

Section 4.139.00 - Significant Resource Overlay Zone (SROZ) Ordinance .....	
Section 4.139.01 - SROZ – Purpose.....	
Section 4.139.02 - Where These Regulations Apply .....	
Section 4.139.03 - Administration .....	
Section 4.139.04 - Uses and Activities Exempt from These Regulations.....	
Section 4.139.05 - Significant Resource Overlay Zone Map Verification.....	
Section 4.139.06 - Significant Resource Impact Report (SRIR) and Review Criteria.....	
Section 4.139.07 - Mitigation Standards .....	
Section 4.139.08 - Activities Requiring a Class I Administrative Review Process <i>(Not Applicable to this Application)</i> .....	
Section 4.139.09 - Activities Requiring a Class II Administrative Review Process .....	
Section 4.139.10 - Development Review Board (DRB) Process .....	
Section 4.139.11 - Special Provisions <i>(Not Applicable to this Application)</i> .....	

<b>General Development Regulations and Standards</b> .....	B-58
Section 4.154 - On-site Pedestrian Access and Circulation .....	
Section 4.155 - General Regulations - Parking, Loading and Bicycle Parking .....	
Section 4.156 - Signage .....	
Section 4.171 - Protection of Natural Features and Other Resources .....	
Section 4.175 - Public Safety and Crime Prevention.....	
Section 4.176 - Landscaping, Screening, and Buffering .....	

Section 4.177 - Street Improvement Standards .....	
Section 4.179 - Mixed Solid Waste and Recyclables Storage in New Multi-Unit Residential and Non-Residential Buildings .....	
Section 4.199 - Outdoor Lighting .....	
<b>Underground Utilities .....</b>	<b>B-146</b>
Section 4.300 – General .....	
Section 4.310 – Exceptions .....	
Section 4.320 – Requirements .....	
<b>Site Design Review (Detailed Review of Architecture, Landscaping, Signs and Other Design Elements) .....</b>	<b>B-148</b>
Section 4.400 - Purpose .....	
Section 4.420 - Jurisdiction and Powers of the Board .....	
Section 4.421 - Criteria and Application of Design Standards .....	
Section 4.430 - Location, Design and Access Standards for Mixed Solid Waste and Recycling Areas .....	
Section 4.440 - Procedure .....	
Section 4.441 - Effective Date of Decisions .....	
Section 4.442 - Time Limit on Approval .....	
Section 4.443 - Preliminary Consideration .....	
Section 4.450 - Installation of Landscaping .....	
<b>Tree Removal .....</b>	<b>B-164</b>
Section 4.600.10 - Purpose and Declaration .....	
Section 4.600.20 - Applicability of Subchapter .....	
Section 4.600.30 - Tree Removal Permit Required .....	
Section 4.600.40 - Exceptions .....	
Section 4.600.50 - Application for Tree Removal Permit .....	
Section 4.610.00 - Application Review Procedure .....	
Section 4.610.10 - Standards for Tree Removal, Relocation Or Replacement .....	
Section 4.610.20 - Type A Permit <i>(Not Applicable to this Application)</i> .....	
Section 4.610.30 - Type B Permit <i>(Not Applicable to this Application)</i> .....	
Section 4.610.40 - Type C Permit .....	
Section 4.610.50 - Type D Permit <i>(Not Applicable to this Application)</i> .....	
Section 4.620.00 - Tree Relocation, Mitigation, Or Replacement .....	
Section 4.620.10 - Tree Protection During Construction .....	
Section 4.620.20 - Maintenance and Protection Standards .....	
Section 4.630.00 – Appeal .....	
Section 4.630.10 - Display of Permit; Inspection .....	
Section 4.630.20 - Variance for Hardship <i>(Not Applicable to this Application)</i> .....	
Section 4.630.30 – Severability <i>(Not Applicable to this Application)</i> .....	
Section 4.640.00 - Violation; Enforcement <i>(Not Applicable to this Application)</i> .....	
Section 4.640.10 - Alternative Enforcement <i>(Not Applicable to this Application)</i> .....	
Section 4.640.20 - Responsibility for Enforcement <i>(Not Applicable to this Application)</i> .....	
<b>Definition of Terms .....</b>	<b>B-194</b>
Section 4.001 – Definition of Terms .....	

**Section C - Exhibit Drawings**

01 Cover Sheet.....

02 Existing Conditions Plan - *Overall* .....

03 On-Site Analysis Plan - *Overall*.....

04 Site Plan – *Overall (Preliminary)* .....

05 Grading and Drainage Plan - *Overall (Preliminary)*.....

06 Utility Plan - *Overall (Preliminary)* .....

07 Tree Protection and Removal Plan - *Overall (Preliminary)*.....

08 Tree Protection and Removal Plan - *Northwest Quadrant (Preliminary)* .....

09 Tree Protection and Removal Plan - *Northeast Quadrant (Preliminary)*.....

10 Tree Protection and Removal Plan - *Southwest Quadrant (Preliminary)* .....

11 Tree Protection and Removal Plan - *Southeast Quadrant (Preliminary)*.....

12 Tree Inventory Table (*Preliminary*).....

13 Tree Inventory Table (*Preliminary*).....

14 Tree Inventory Table (*Preliminary*).....

15 Tree Inventory Table (*Preliminary*).....

16 Landscape Plan - *Overall (Preliminary)* .....

17 Landscape Plan - *Northwest Quadrant (Preliminary)* .....

18 Landscape Plan - *Northeast Quadrant (Preliminary)*.....

19 Landscape Plan - *Southwest Quadrant (Preliminary)* .....

20 Landscape Plan - *Southeast Quadrant (Preliminary)*.....

21 Buffer Enhancement Plan (*Preliminary*) .....

22 Detailed Landscape Plans (*Preliminary*).....

23 Landscape Details and Plant Schedules (*Preliminary*) .....

24 Plaza Hardscape Plan (*Preliminary*) .....

25 Hardscape Details (*Preliminary*) .....

26 Tree Canopy Coverage Plan (*Preliminary*) .....

27 Site Lighting Plan (*Preliminary*) (*Overall*) .....

28 Floor Plan (*Preliminary*) .....

29 Building Elevations (*Preliminary*).....

30 Building Elevations (*Preliminary*).....

31 Building Elevations (*Preliminary*).....

**Section D - Appendices**

Appendix 1 Partition Plat – 2018-109 (*OTAK, Inc.*) .....

Appendix 2 TRIO (*Chicago Title Company*) .....

Appendix 3 Assessors Tax Map (*Washington County*) .....

Appendix 4 Comprehensive Plan Map (*City of Wilsonville*) .....

Appendix 5	Zoning Map ( <i>City of Wilsonville</i> ) .....
Appendix 6	Pre-Application Submittal Request .....
Appendix 7	Pre-Application Summary Notes ( <i>City of Wilsonville</i> ) .....
Appendix 8	Staff Report/Notice of Decision for Prior Land Use Approvals ( <i>City of Wilsonville</i> ) .....
Appendix 9	Land Donation Resolution Number 2731 ( <i>City of Wilsonville</i> ) .....
Appendix 10	Local Wetlands and Riparian Corridor Inventory ( <i>City of Wilsonville</i> ) .....
Appendix 11	Significant Resource Overlay Zone (SROZ) Map ( <i>City of Wilsonville</i> ) .....
Appendix 12	Wetland Delineation Report ( <i>Pacific Habitats, Inc.</i> ) .....
Appendix 13	Significant Resource Impact Report (SRIR) ( <i>Pacific Habitats, Inc.</i> ) .....
Appendix 14	Joint Cut/Fill Permit ( <i>Pacific Habitats, Inc.</i> ) .....
Appendix 15	Approved Jurisdictional Determination ( <i>US Corp of Engineers</i> ) .....
Appendix 16	Tree Inventory ( <i>Teragan &amp; Associates, LLC</i> ) .....
Appendix 17	Arborist Report ( <i>Teragan &amp; Associates, LLC</i> ) .....
Appendix 18	Soils Map ( <i>NRCS</i> ) .....
Appendix 19	Geotechnical Report ( <i>GeoDesign, Inc.</i> ) .....
Appendix 20	Storm Water Drainage Report ( <i>Atwell, LLC</i> ) .....
Appendix 21	Traffic Impact Study Waiver .....
Appendix 22	TVFR Land Use Review Application ( <i>Tualatin Valley Fire &amp; Rescue</i> ) .....
Appendix 23	WB-67 Semi-Trailer Truck Vehicle Tracking Exhibit ( <i>Atwell, LLC</i> ) .....
Appendix 24	Franchise Garbage Hauler Service Provider Letter/Memorandum ( <i>Republic Services</i> ) .....
Appendix 25	Color Materials Board ( <i>Mildren Design Group, PC</i> ) .....
Appendix 26	Outdoor Furnishings Manufacturers Product Sheet (picnic tables, benches, bike racks, trash receptacles and shelter) .....
Appendix 27	Entry Renderings .....
Appendix 28	Lighting Overlay Zone Map ( <i>City of Wilsonville</i> ) .....
Appendix 29	Lighting Manufacturers Product Sheets (poles and fixtures) ( <i>Harry L Stearns</i> ) .....
Appendix 30	Master Sign Plan ( <i>FINE</i> ) .....
Appendix 31	Real Estate Broker Opinion Letter ( <i>Kidder Mathews</i> ) .....
Appendix 32	Entry Plaza Rendering .....

**Section A - Introduction**

- 1. Development Team Members .....A-1
- 2. Property and Zoning Summary .....A-3
- 3. Background Information .....A-3
- 4. Project Summary.....A-3
- 5. Key Issues.....A-5
- 6. Prior Land Use Approvals.....A-6
- 7. Land Use Reviews Requested .....A-7
- 8. Application Fee Calculations.....A-7

**Section B - Applicable Development Code Narrative**

**Standards applying to all Planned Development Zones .....B-1**  
Section 4.118 - Standards applying to all Planned Development Zones .....

**Planned Development Regulations .....B-11**  
Section 4.140 – Planned Development Regulations.....

**Use and Zone Specific Standards and Regulations .....B-23**  
Section 4.117 - Standards Applying To Industrial Developments In Any Zone.....  
Section 4.135 - PDI- Planned Development Industrial Zone.....

**Overlay Zones and Area Specific Regulations, including Design, Natural Resources, Interchange  
Area Traffic Management .....B-32**

- Section 4.139.00 - Significant Resource Overlay Zone (SROZ) Ordinance .....
- Section 4.139.01 - SROZ – Purpose.....
- Section 4.139.02 - Where These Regulations Apply .....
- Section 4.139.03 - Administration .....
- Section 4.139.04 - Uses and Activities Exempt from These Regulations.....
- Section 4.139.05 - Significant Resource Overlay Zone Map Verification.....
- Section 4.139.06 - Significant Resource Impact Report (SRIR) and Review Criteria.....
- Section 4.139.07 - Mitigation Standards .....
- Section 4.139.08 - Activities Requiring a Class I Administrative Review Process *(Not Applicable to this Application)* .....
- Section 4.139.09 - Activities Requiring a Class II Administrative Review Process .....
- Section 4.139.10 - Development Review Board (DRB) Process .....
- Section 4.139.11 - Special Provisions *(Not Applicable to this Application)*.....

**General Development Regulations and Standards .....B-58**

- Section 4.154 - On-site Pedestrian Access and Circulation .....
- Section 4.155 - General Regulations - Parking, Loading and Bicycle Parking .....
- Section 4.156 - Signage .....
- Section 4.171 - Protection of Natural Features and Other Resources .....
- Section 4.175 - Public Safety and Crime Prevention.....
- Section 4.176 - Landscaping, Screening, and Buffering .....

Section 4.177 - Street Improvement Standards .....	
Section 4.179 - Mixed Solid Waste and Recyclables Storage in New Multi-Unit Residential and Non-Residential Buildings .....	
Section 4.199 - Outdoor Lighting .....	
<b>Underground Utilities</b> .....	B-146
Section 4.300 – General .....	
Section 4.310 – Exceptions .....	
Section 4.320 – Requirements .....	
<b>Site Design Review (Detailed Review of Architecture, Landscaping, Signs and Other Design Elements</b> .....	B-148
Section 4.400 - Purpose .....	
Section 4.420 - Jurisdiction and Powers of the Board .....	
Section 4.421 - Criteria and Application of Design Standards .....	
Section 4.430 - Location, Design and Access Standards for Mixed Solid Waste and Recycling Areas .....	
Section 4.440 - Procedure .....	
Section 4.441 - Effective Date of Decisions .....	
Section 4.442 - Time Limit on Approval .....	
Section 4.443 - Preliminary Consideration .....	
Section 4.450 - Installation of Landscaping .....	
<b>Tree Removal</b> .....	B-164
Section 4.600.10 - Purpose and Declaration .....	
Section 4.600.20 - Applicability of Subchapter .....	
Section 4.600.30 - Tree Removal Permit Required .....	
Section 4.600.40 - Exceptions .....	
Section 4.600.50 - Application for Tree Removal Permit .....	
Section 4.610.00 - Application Review Procedure .....	
Section 4.610.10 - Standards for Tree Removal, Relocation Or Replacement .....	
Section 4.610.20 - Type A Permit <i>(Not Applicable to this Application)</i> .....	
Section 4.610.30 - Type B Permit <i>(Not Applicable to this Application)</i> .....	
Section 4.610.40 - Type C Permit .....	
Section 4.610.50 - Type D Permit <i>(Not Applicable to this Application)</i> .....	
Section 4.620.00 - Tree Relocation, Mitigation, Or Replacement .....	
Section 4.620.10 - Tree Protection During Construction .....	
Section 4.620.20 - Maintenance and Protection Standards .....	
Section 4.630.00 – Appeal .....	
Section 4.630.10 - Display of Permit; Inspection .....	
Section 4.630.20 - Variance for Hardship <i>(Not Applicable to this Application)</i> .....	
Section 4.630.30 – Severability <i>(Not Applicable to this Application)</i> .....	
Section 4.640.00 - Violation; Enforcement <i>(Not Applicable to this Application)</i> .....	
Section 4.640.10 - Alternative Enforcement <i>(Not Applicable to this Application)</i> .....	
Section 4.640.20 - Responsibility for Enforcement <i>(Not Applicable to this Application)</i> .....	
<b>Definition of Terms</b> .....	B-194
Section 4.001 – Definition of Terms .....	

**Section C - Exhibit Drawings**

01 Cover Sheet.....

02 Existing Conditions Plan - *Overall* .....

03 On-Site Analysis Plan - *Overall*.....

04 Site Plan – *Overall (Preliminary)* .....

05 Grading and Drainage Plan - *Overall (Preliminary)*.....

06 Utility Plan - *Overall (Preliminary)* .....

07 Tree Protection and Removal Plan - *Overall (Preliminary)*.....

08 Tree Protection and Removal Plan - *Northwest Quadrant (Preliminary)*.....

09 Tree Protection and Removal Plan - *Northeast Quadrant (Preliminary)*.....

10 Tree Protection and Removal Plan - *Southwest Quadrant (Preliminary)*.....

11 Tree Protection and Removal Plan - *Southeast Quadrant (Preliminary)*.....

12 Tree Inventory Table (*Preliminary*).....

13 Tree Inventory Table (*Preliminary*).....

14 Tree Inventory Table (*Preliminary*).....

15 Tree Inventory Table (*Preliminary*).....

16 Landscape Plan - *Overall (Preliminary)*.....

17 Landscape Plan - *Northwest Quadrant (Preliminary)*.....

18 Landscape Plan - *Northeast Quadrant (Preliminary)*.....

19 Landscape Plan - *Southwest Quadrant (Preliminary)*.....

20 Landscape Plan - *Southeast Quadrant (Preliminary)*.....

21 Buffer Enhancement Plan (*Preliminary*).....

22 Detailed Landscape Plans (*Preliminary*).....

23 Landscape Details and Plant Schedules (*Preliminary*).....

24 Plaza Hardscape Plan (*Preliminary*).....

25 Hardscape Details (*Preliminary*).....

26 Tree Canopy Coverage Plan (*Preliminary*).....

27 Site Lighting Plan (*Preliminary*) (*Overall*).....

28 Floor Plan (*Preliminary*).....

29 Building Elevations (*Preliminary*).....

30 Building Elevations (*Preliminary*).....

31 Building Elevations (*Preliminary*).....

**Section D - Appendices**

Appendix 1 Partition Plat – 2018-109 (*OTAK, Inc.*).....

Appendix 2 TRIO (*Chicago Title Company*).....

Appendix 3 Assessors Tax Map (*Washington County*).....

Appendix 4 Comprehensive Plan Map (*City of Wilsonville*).....



Appendix 5	Zoning Map ( <i>City of Wilsonville</i> ) .....
Appendix 6	Pre-Application Submittal Request .....
Appendix 7	Pre-Application Summary Notes ( <i>City of Wilsonville</i> ) .....
Appendix 8	Staff Report/Notice of Decision for Prior Land Use Approvals ( <i>City of Wilsonville</i> ) .....
Appendix 9	Land Donation Resolution Number 2731 ( <i>City of Wilsonville</i> ) .....
Appendix 10	Local Wetlands and Riparian Corridor Inventory ( <i>City of Wilsonville</i> ) .....
Appendix 11	Significant Resource Overlay Zone (SROZ) Map ( <i>City of Wilsonville</i> ) .....
Appendix 12	Wetland Delineation Report ( <i>Pacific Habitats, Inc.</i> ) .....
Appendix 13	Significant Resource Impact Report (SRIR) ( <i>Pacific Habitats, Inc.</i> ) .....
Appendix 14	Joint Cut/Fill Permit ( <i>Pacific Habitats, Inc.</i> ) .....
Appendix 15	Approved Jurisdictional Determination ( <i>US Corp of Engineers</i> ) .....
Appendix 16	Tree Inventory ( <i>Teragan &amp; Associates, LLC</i> ) .....
Appendix 17	Arborist Report ( <i>Teragan &amp; Associates, LLC</i> ) .....
Appendix 18	Soils Map ( <i>NRCS</i> ) .....
Appendix 19	Geotechnical Report ( <i>GeoDesign, Inc.</i> ) .....
Appendix 20	Storm Water Drainage Report ( <i>Atwell, LLC</i> ) .....
Appendix 21	Traffic Impact Study Waiver .....
Appendix 22	TVFR Land Use Review Application ( <i>Tualatin Valley Fire &amp; Rescue</i> ) .....
Appendix 23	WB-67 Semi-Trailer Truck Vehicle Tracking Exhibit ( <i>Atwell, LLC</i> ) .....
Appendix 24	Franchise Garbage Hauler Service Provider Letter/Memorandum ( <i>Republic Services</i> ) .....
Appendix 25	Color Materials Board ( <i>Mildren Design Group, PC</i> ) .....
Appendix 26	Outdoor Furnishings Manufacturers Product Sheet (picnic tables, benches, bike racks, trash receptacles and shelter) .....
Appendix 27	Entry Renderings .....
Appendix 28	Lighting Overlay Zone Map ( <i>City of Wilsonville</i> ) .....
Appendix 29	Lighting Manufacturers Product Sheets (poles and fixtures) ( <i>Harry L Stearns</i> ) .....
Appendix 30	Master Sign Plan ( <i>FINE</i> ) .....
Appendix 31	Real Estate Broker Opinion Letter ( <i>Kidder Mathews</i> ) .....
Appendix 32	Entry Plaza Rendering .....

**Section A - Introduction**

1. Development Team Members .....	A-1
2. Property and Zoning Summary .....	A-3
3. Background Information .....	A-3
4. Project Summary.....	A-3
5. Key Issues.....	A-5
6. Prior Land Use Approvals.....	A-6
7. Land Use Reviews Requested .....	A-7
8. Application Fee Calculations.....	A-7

**Section B - Applicable Development Code Narrative**

<b>Standards applying to all Planned Development Zones</b> .....	B-1
Section 4.118 - Standards applying to all Planned Development Zones .....	

<b>Planned Development Regulations</b> .....	B-11
Section 4.140 – Planned Development Regulations.....	

<b>Use and Zone Specific Standards and Regulations</b> .....	B-23
Section 4.117 - Standards Applying To Industrial Developments In Any Zone.....	
Section 4.135 - PDI- Planned Development Industrial Zone.....	

<b>Overlay Zones and Area Specific Regulations, including Design, Natural Resources, Interchange Area Traffic Management</b> .....	B-32
--	------

Section 4.139.00 - Significant Resource Overlay Zone (SROZ) Ordinance .....	
Section 4.139.01 - SROZ – Purpose.....	
Section 4.139.02 - Where These Regulations Apply .....	
Section 4.139.03 - Administration .....	
Section 4.139.04 - Uses and Activities Exempt from These Regulations.....	
Section 4.139.05 - Significant Resource Overlay Zone Map Verification.....	
Section 4.139.06 - Significant Resource Impact Report (SRIR) and Review Criteria.....	
Section 4.139.07 - Mitigation Standards .....	
Section 4.139.08 - Activities Requiring a Class I Administrative Review Process <i>(Not Applicable to this Application)</i> .....	
Section 4.139.09 - Activities Requiring a Class II Administrative Review Process .....	
Section 4.139.10 - Development Review Board (DRB) Process .....	
Section 4.139.11 - Special Provisions <i>(Not Applicable to this Application)</i> .....	

<b>General Development Regulations and Standards</b> .....	B-58
Section 4.154 - On-site Pedestrian Access and Circulation .....	
Section 4.155 - General Regulations - Parking, Loading and Bicycle Parking .....	
Section 4.156 - Signage .....	
Section 4.171 - Protection of Natural Features and Other Resources .....	
Section 4.175 - Public Safety and Crime Prevention.....	
Section 4.176 - Landscaping, Screening, and Buffering .....	

Section 4.177 - Street Improvement Standards .....	
Section 4.179 - Mixed Solid Waste and Recyclables Storage in New Multi-Unit Residential and Non-Residential Buildings .....	
Section 4.199 - Outdoor Lighting .....	
<b>Underground Utilities .....</b>	<b>B-146</b>
Section 4.300 – General .....	
Section 4.310 – Exceptions .....	
Section 4.320 – Requirements .....	
<b>Site Design Review (Detailed Review of Architecture, Landscaping, Signs and Other Design Elements) .....</b>	<b>B-148</b>
Section 4.400 - Purpose .....	
Section 4.420 - Jurisdiction and Powers of the Board .....	
Section 4.421 - Criteria and Application of Design Standards .....	
Section 4.430 - Location, Design and Access Standards for Mixed Solid Waste and Recycling Areas .....	
Section 4.440 - Procedure .....	
Section 4.441 - Effective Date of Decisions .....	
Section 4.442 - Time Limit on Approval .....	
Section 4.443 - Preliminary Consideration .....	
Section 4.450 - Installation of Landscaping .....	
<b>Tree Removal .....</b>	<b>B-164</b>
Section 4.600.10 - Purpose and Declaration .....	
Section 4.600.20 - Applicability of Subchapter .....	
Section 4.600.30 - Tree Removal Permit Required .....	
Section 4.600.40 - Exceptions .....	
Section 4.600.50 - Application for Tree Removal Permit .....	
Section 4.610.00 - Application Review Procedure .....	
Section 4.610.10 - Standards for Tree Removal, Relocation Or Replacement .....	
Section 4.610.20 - Type A Permit <i>(Not Applicable to this Application)</i> .....	
Section 4.610.30 - Type B Permit <i>(Not Applicable to this Application)</i> .....	
Section 4.610.40 - Type C Permit .....	
Section 4.610.50 - Type D Permit <i>(Not Applicable to this Application)</i> .....	
Section 4.620.00 - Tree Relocation, Mitigation, Or Replacement .....	
Section 4.620.10 - Tree Protection During Construction .....	
Section 4.620.20 - Maintenance and Protection Standards .....	
Section 4.630.00 – Appeal .....	
Section 4.630.10 - Display of Permit; Inspection .....	
Section 4.630.20 - Variance for Hardship <i>(Not Applicable to this Application)</i> .....	
Section 4.630.30 – Severability <i>(Not Applicable to this Application)</i> .....	
Section 4.640.00 - Violation; Enforcement <i>(Not Applicable to this Application)</i> .....	
Section 4.640.10 - Alternative Enforcement <i>(Not Applicable to this Application)</i> .....	
Section 4.640.20 - Responsibility for Enforcement <i>(Not Applicable to this Application)</i> .....	
<b>Definition of Terms .....</b>	<b>B-194</b>
Section 4.001 – Definition of Terms .....	

**Section C - Exhibit Drawings**

01 Cover Sheet.....

02 Existing Conditions Plan - *Overall* .....

03 On-Site Analysis Plan - *Overall*.....

04 Site Plan – *Overall (Preliminary)* .....

05 Grading and Drainage Plan - *Overall (Preliminary)*.....

06 Utility Plan - *Overall (Preliminary)* .....

07 Tree Protection and Removal Plan - *Overall (Preliminary)*.....

08 Tree Protection and Removal Plan - *Northwest Quadrant (Preliminary)*.....

09 Tree Protection and Removal Plan - *Northeast Quadrant (Preliminary)*.....

10 Tree Protection and Removal Plan - *Southwest Quadrant (Preliminary)*.....

11 Tree Protection and Removal Plan - *Southeast Quadrant (Preliminary)*.....

12 Tree Inventory Table (*Preliminary*).....

13 Tree Inventory Table (*Preliminary*).....

14 Tree Inventory Table (*Preliminary*).....

15 Tree Inventory Table (*Preliminary*).....

16 Landscape Plan - *Overall (Preliminary)* .....

17 Landscape Plan - *Northwest Quadrant (Preliminary)* .....

18 Landscape Plan - *Northeast Quadrant (Preliminary)*.....

19 Landscape Plan - *Southwest Quadrant (Preliminary)* .....

20 Landscape Plan - *Southeast Quadrant (Preliminary)*.....

21 Buffer Enhancement Plan (*Preliminary*) .....

22 Detailed Landscape Plans (*Preliminary*).....

23 Landscape Details and Plant Schedules (*Preliminary*) .....

24 Plaza Hardscape Plan (*Preliminary*) .....

25 Hardscape Details (*Preliminary*) .....

26 Tree Canopy Coverage Plan (*Preliminary*) .....

27 Site Lighting Plan (*Preliminary*) (*Overall*) .....

28 Floor Plan (*Preliminary*) .....

29 Building Elevations (*Preliminary*).....

30 Building Elevations (*Preliminary*).....

31 Building Elevations (*Preliminary*).....

**Section D - Appendices**

Appendix 1 Partition Plat – 2018-109 (*OTAK, Inc.*) .....

Appendix 2 TRIO (*Chicago Title Company*) .....

Appendix 3 Assessors Tax Map (*Washington County*) .....

Appendix 4 Comprehensive Plan Map (*City of Wilsonville*) .....

Appendix 5	Zoning Map ( <i>City of Wilsonville</i> ) .....
Appendix 6	Pre-Application Submittal Request .....
Appendix 7	Pre-Application Summary Notes ( <i>City of Wilsonville</i> ) .....
Appendix 8	Staff Report/Notice of Decision for Prior Land Use Approvals ( <i>City of Wilsonville</i> ) .....
Appendix 9	Land Donation Resolution Number 2731 ( <i>City of Wilsonville</i> ) .....
Appendix 10	Local Wetlands and Riparian Corridor Inventory ( <i>City of Wilsonville</i> ) .....
Appendix 11	Significant Resource Overlay Zone (SROZ) Map ( <i>City of Wilsonville</i> ) .....
Appendix 12	Wetland Delineation Report ( <i>Pacific Habitats, Inc.</i> ) .....
Appendix 13	Significant Resource Impact Report (SRIR) ( <i>Pacific Habitats, Inc.</i> ) .....
Appendix 14	Joint Cut/Fill Permit ( <i>Pacific Habitats, Inc.</i> ) .....
Appendix 15	Approved Jurisdictional Determination ( <i>US Corp of Engineers</i> ) .....
Appendix 16	Tree Inventory ( <i>Teragan &amp; Associates, LLC</i> ) .....
Appendix 17	Arborist Report ( <i>Teragan &amp; Associates, LLC</i> ) .....
Appendix 18	Soils Map ( <i>NRCS</i> ) .....
Appendix 19	Geotechnical Report ( <i>GeoDesign, Inc.</i> ) .....
Appendix 20	Storm Water Drainage Report ( <i>Atwell, LLC</i> ) .....
Appendix 21	Traffic Impact Study Waiver .....
Appendix 22	TVFR Land Use Review Application ( <i>Tualatin Valley Fire &amp; Rescue</i> ) .....
Appendix 23	WB-67 Semi-Trailer Truck Vehicle Tracking Exhibit ( <i>Atwell, LLC</i> ) .....
Appendix 24	Franchise Garbage Hauler Service Provider Letter/Memorandum ( <i>Republic Services</i> ) .....
Appendix 25	Color Materials Board ( <i>Mildren Design Group, PC</i> ) .....
Appendix 26	Outdoor Furnishings Manufacturers Product Sheet (picnic tables, benches, bike racks, trash receptacles and shelter) .....
Appendix 27	Entry Renderings .....
Appendix 28	Lighting Overlay Zone Map ( <i>City of Wilsonville</i> ) .....
Appendix 29	Lighting Manufacturers Product Sheets (poles and fixtures) ( <i>Harry L Stearns</i> ) .....
Appendix 30	Master Sign Plan ( <i>FINE</i> ) .....
Appendix 31	Real Estate Broker Opinion Letter ( <i>Kidder Mathews</i> ) .....
Appendix 32	Entry Plaza Rendering .....

**Section A - Introduction**

1. Development Team Members .....A-1  
2. Property and Zoning Summary .....A-3  
3. Background Information .....A-3  
4. Project Summary.....A-3  
5. Key Issues.....A-5  
6. Prior Land Use Approvals.....A-6  
7. Land Use Reviews Requested .....A-7  
8. Application Fee Calculations.....A-7

**Section B - Applicable Development Code Narrative**

**Standards applying to all Planned Development Zones** .....B-1  
Section 4.118 - Standards applying to all Planned Development Zones .....

**Planned Development Regulations** .....B-11  
Section 4.140 – Planned Development Regulations.....

**Use and Zone Specific Standards and Regulations** .....B-23  
Section 4.117 - Standards Applying To Industrial Developments In Any Zone.....  
Section 4.135 - PDI- Planned Development Industrial Zone.....

**Overlay Zones and Area Specific Regulations, including Design, Natural Resources, Interchange Area Traffic Management** .....B-32

Section 4.139.00 - Significant Resource Overlay Zone (SROZ) Ordinance .....  
Section 4.139.01 - SROZ – Purpose.....  
Section 4.139.02 - Where These Regulations Apply .....  
Section 4.139.03 - Administration .....  
Section 4.139.04 - Uses and Activities Exempt from These Regulations.....  
Section 4.139.05 - Significant Resource Overlay Zone Map Verification.....  
Section 4.139.06 - Significant Resource Impact Report (SRIR) and Review Criteria.....  
Section 4.139.07 - Mitigation Standards .....  
Section 4.139.08 - Activities Requiring a Class I Administrative Review Process (*Not Applicable to this Application*) .....  
Section 4.139.09 - Activities Requiring a Class II Administrative Review Process .....  
Section 4.139.10 - Development Review Board (DRB) Process .....  
Section 4.139.11 - Special Provisions (*Not Applicable to this Application*).....

**General Development Regulations and Standards** .....B-58  
Section 4.154 - On-site Pedestrian Access and Circulation .....  
Section 4.155 - General Regulations - Parking, Loading and Bicycle Parking .....  
Section 4.156 - Signage .....  
Section 4.171 - Protection of Natural Features and Other Resources .....  
Section 4.175 - Public Safety and Crime Prevention.....  
Section 4.176 - Landscaping, Screening, and Buffering.....

Section 4.177 - Street Improvement Standards .....	
Section 4.179 - Mixed Solid Waste and Recyclables Storage in New Multi-Unit Residential and Non-Residential Buildings .....	
Section 4.199 - Outdoor Lighting .....	
<b>Underground Utilities</b> .....	B-146
Section 4.300 – General .....	
Section 4.310 – Exceptions .....	
Section 4.320 – Requirements .....	
<b>Site Design Review (Detailed Review of Architecture, Landscaping, Signs and Other Design Elements</b> .....	B-148
Section 4.400 - Purpose .....	
Section 4.420 - Jurisdiction and Powers of the Board .....	
Section 4.421 - Criteria and Application of Design Standards .....	
Section 4.430 - Location, Design and Access Standards for Mixed Solid Waste and Recycling Areas .....	
Section 4.440 - Procedure .....	
Section 4.441 - Effective Date of Decisions .....	
Section 4.442 - Time Limit on Approval .....	
Section 4.443 - Preliminary Consideration .....	
Section 4.450 - Installation of Landscaping .....	
<b>Tree Removal</b> .....	B-164
Section 4.600.10 - Purpose and Declaration .....	
Section 4.600.20 - Applicability of Subchapter .....	
Section 4.600.30 - Tree Removal Permit Required .....	
Section 4.600.40 - Exceptions .....	
Section 4.600.50 - Application for Tree Removal Permit .....	
Section 4.610.00 - Application Review Procedure .....	
Section 4.610.10 - Standards for Tree Removal, Relocation Or Replacement .....	
Section 4.610.20 - Type A Permit <i>(Not Applicable to this Application)</i> .....	
Section 4.610.30 - Type B Permit <i>(Not Applicable to this Application)</i> .....	
Section 4.610.40 - Type C Permit .....	
Section 4.610.50 - Type D Permit <i>(Not Applicable to this Application)</i> .....	
Section 4.620.00 - Tree Relocation, Mitigation, Or Replacement .....	
Section 4.620.10 - Tree Protection During Construction .....	
Section 4.620.20 - Maintenance and Protection Standards .....	
Section 4.630.00 – Appeal .....	
Section 4.630.10 - Display of Permit; Inspection .....	
Section 4.630.20 - Variance for Hardship <i>(Not Applicable to this Application)</i> .....	
Section 4.630.30 – Severability <i>(Not Applicable to this Application)</i> .....	
Section 4.640.00 - Violation; Enforcement <i>(Not Applicable to this Application)</i> .....	
Section 4.640.10 - Alternative Enforcement <i>(Not Applicable to this Application)</i> .....	
Section 4.640.20 - Responsibility for Enforcement <i>(Not Applicable to this Application)</i> .....	
<b>Definition of Terms</b> .....	B-194
Section 4.001 – Definition of Terms .....	

**Section C - Exhibit Drawings**

01 Cover Sheet.....

02 Existing Conditions Plan - *Overall* .....

03 On-Site Analysis Plan - *Overall*.....

04 Site Plan – *Overall (Preliminary)* .....

05 Grading and Drainage Plan - *Overall (Preliminary)*.....

06 Utility Plan - *Overall (Preliminary)* .....

07 Tree Protection and Removal Plan - *Overall (Preliminary)*.....

08 Tree Protection and Removal Plan - *Northwest Quadrant (Preliminary)*.....

09 Tree Protection and Removal Plan - *Northeast Quadrant (Preliminary)*.....

10 Tree Protection and Removal Plan - *Southwest Quadrant (Preliminary)*.....

11 Tree Protection and Removal Plan - *Southeast Quadrant (Preliminary)*.....

12 Tree Inventory Table (*Preliminary*).....

13 Tree Inventory Table (*Preliminary*).....

14 Tree Inventory Table (*Preliminary*).....

15 Tree Inventory Table (*Preliminary*).....

16 Landscape Plan - *Overall (Preliminary)* .....

17 Landscape Plan - *Northwest Quadrant (Preliminary)* .....

18 Landscape Plan - *Northeast Quadrant (Preliminary)*.....

19 Landscape Plan - *Southwest Quadrant (Preliminary)* .....

20 Landscape Plan - *Southeast Quadrant (Preliminary)*.....

21 Buffer Enhancement Plan (*Preliminary*) .....

22 Detailed Landscape Plans (*Preliminary*).....

23 Landscape Details and Plant Schedules (*Preliminary*) .....

24 Plaza Hardscape Plan (*Preliminary*) .....

25 Hardscape Details (*Preliminary*) .....

26 Tree Canopy Coverage Plan (*Preliminary*) .....

27 Site Lighting Plan (*Preliminary*) (*Overall*) .....

28 Floor Plan (*Preliminary*) .....

29 Building Elevations (*Preliminary*).....

30 Building Elevations (*Preliminary*).....

31 Building Elevations (*Preliminary*).....

**Section D - Appendices**

Appendix 1 Partition Plat – 2018-109 (*OTAK, Inc.*) .....

Appendix 2 TRIO (*Chicago Title Company*) .....

Appendix 3 Assessors Tax Map (*Washington County*) .....

Appendix 4 Comprehensive Plan Map (*City of Wilsonville*) .....



Appendix 5	Zoning Map ( <i>City of Wilsonville</i> ) .....
Appendix 6	Pre-Application Submittal Request .....
Appendix 7	Pre-Application Summary Notes ( <i>City of Wilsonville</i> ) .....
Appendix 8	Staff Report/Notice of Decision for Prior Land Use Approvals ( <i>City of Wilsonville</i> ) .....
Appendix 9	Land Donation Resolution Number 2731 ( <i>City of Wilsonville</i> ) .....
Appendix 10	Local Wetlands and Riparian Corridor Inventory ( <i>City of Wilsonville</i> ) .....
Appendix 11	Significant Resource Overlay Zone (SROZ) Map ( <i>City of Wilsonville</i> ) .....
Appendix 12	Wetland Delineation Report ( <i>Pacific Habitats, Inc.</i> ) .....
Appendix 13	Significant Resource Impact Report (SRIR) ( <i>Pacific Habitats, Inc.</i> ) .....
Appendix 14	Joint Cut/Fill Permit ( <i>Pacific Habitats, Inc.</i> ) .....
Appendix 15	Approved Jurisdictional Determination ( <i>US Corp of Engineers</i> ) .....
Appendix 16	Tree Inventory ( <i>Teragan &amp; Associates, LLC</i> ) .....
Appendix 17	Arborist Report ( <i>Teragan &amp; Associates, LLC</i> ) .....
Appendix 18	Soils Map ( <i>NRCS</i> ) .....
Appendix 19	Geotechnical Report ( <i>GeoDesign, Inc.</i> ) .....
Appendix 20	Storm Water Drainage Report ( <i>Atwell, LLC</i> ) .....
Appendix 21	Traffic Impact Study Waiver .....
Appendix 22	TVFR Land Use Review Application ( <i>Tualatin Valley Fire &amp; Rescue</i> ) .....
Appendix 23	WB-67 Semi-Trailer Truck Vehicle Tracking Exhibit ( <i>Atwell, LLC</i> ) .....
Appendix 24	Franchise Garbage Hauler Service Provider Letter/Memorandum ( <i>Republic Services</i> ) .....
Appendix 25	Color Materials Board ( <i>Mildren Design Group, PC</i> ) .....
Appendix 26	Outdoor Furnishings Manufacturers Product Sheet (picnic tables, benches, bike racks, trash receptacles and shelter) .....
Appendix 27	Entry Renderings .....
Appendix 28	Lighting Overlay Zone Map ( <i>City of Wilsonville</i> ) .....
Appendix 29	Lighting Manufacturers Product Sheets (poles and fixtures) ( <i>Harry L Stearns</i> ) .....
Appendix 30	Master Sign Plan ( <i>FINE</i> ) .....
Appendix 31	Real Estate Broker Opinion Letter ( <i>Kidder Mathews</i> ) .....
Appendix 32	Entry Plaza Rendering .....