

SPECIFIC AREA PLAN - NORTH VILLEBOIS

CITY OF WILSONVILLE, OREGON

APPLICANT:

POLYGON WLH, LLC
109 E. 13TH ST.
VANCOUVER, WA 98660
[P] 503-221-1920
CONTACT: JASON BAKER

PLANNER:

PACIFIC COMMUNITY DESIGN, INC
12564 SW MAIN STREET
TIGARD, OR 97223
[P] 503-941-9484
CONTACT: STACY CONNERY, AICP

CIVIL ENGINEER:

PACIFIC COMMUNITY DESIGN, INC
12564 SW MAIN STREET
TIGARD, OR 97223
[P] 503-941-9484
CONTACT: JESSIE KING, PE

SURVEYOR:

PACIFIC COMMUNITY DESIGN, INC
12564 SW MAIN STREET
TIGARD, OR 97223
[P] 503-941-9484
CONTACT: TRAVIS JANSEN, PLS, PE

LANDSCAPE ARCHITECT:

PACIFIC COMMUNITY DESIGN, INC
12564 SW MAIN STREET
TIGARD, OR 97223
[P] 503-941-9484
CONTACT: KERRY LANKFORD, RLA

GEOTECHNICAL ENGINEER:

GEODESIGN, INC.
15575 SW SEQUOIA PARKWAY, SUITE 100
PORTLAND, OR 97224
[P] 503-968-8787
CONTACT: SHAWN DIMKE, PE

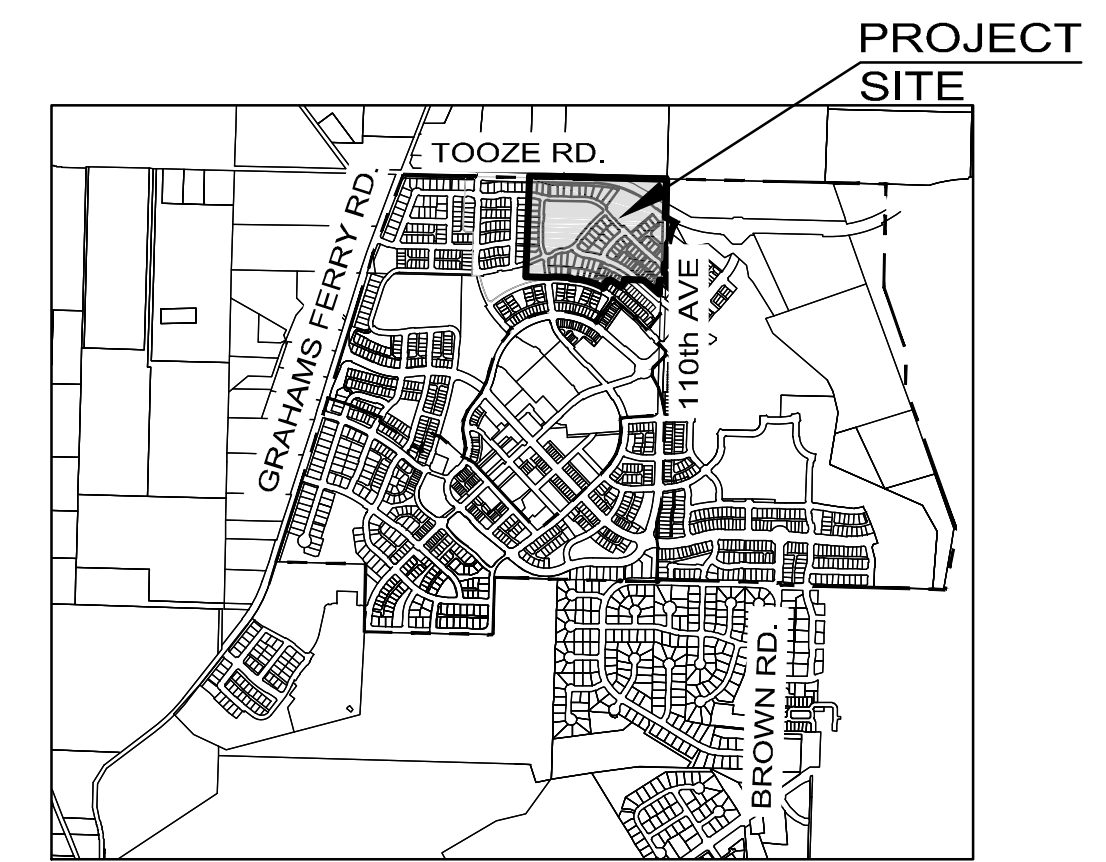
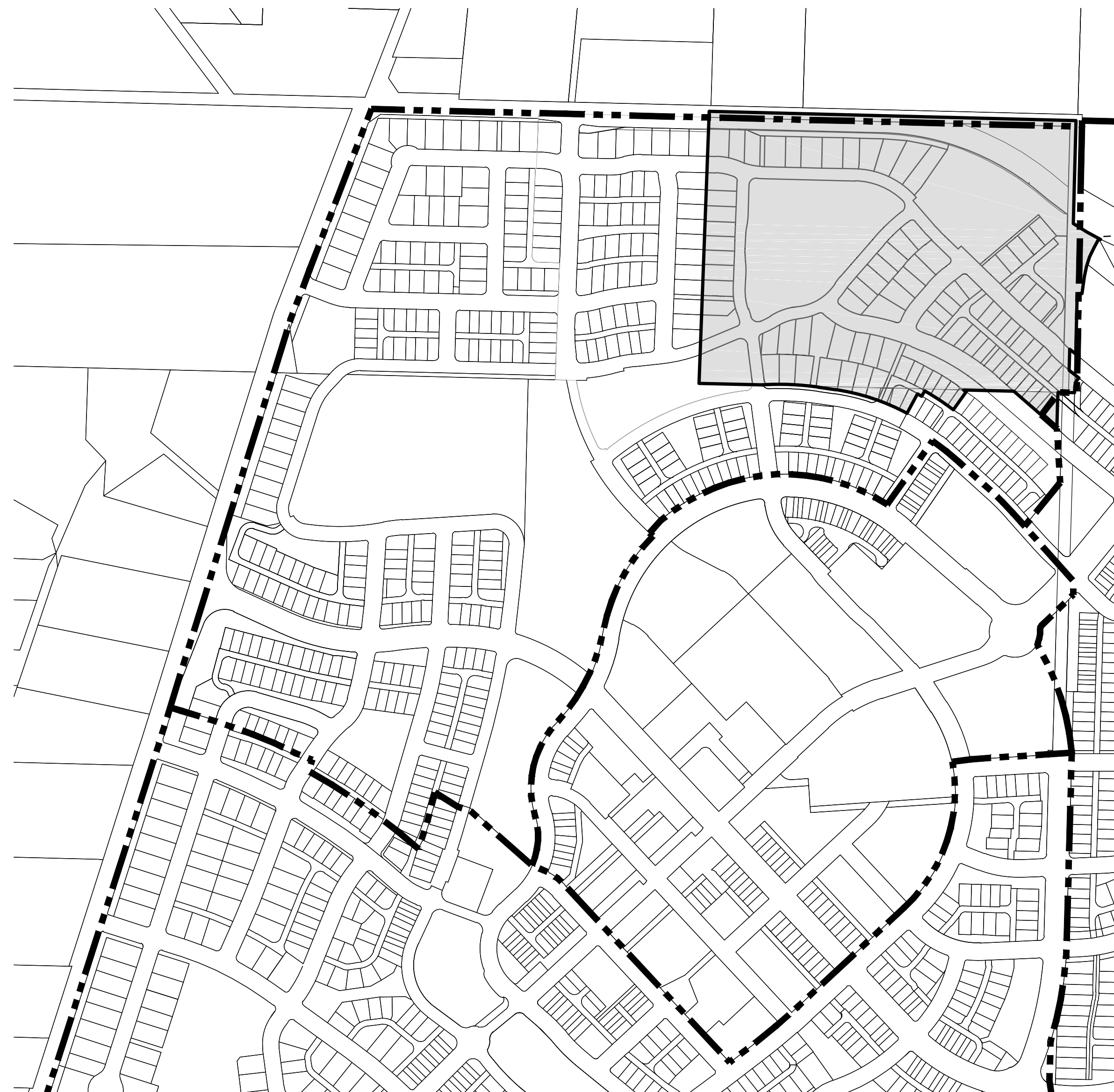

VICINITY MAP

UTILITIES & SERVICES:

WATER:	CITY OF WILSONVILLE
STORM:	CITY OF WILSONVILLE
SEWER:	CITY OF WILSONVILLE
POWER:	PORTLAND GENERAL ELECTRIC
GAS:	NORTHWEST NATURAL
FIRE:	TUALATIN VALLEY FIRE & RESCUE
POLICE:	CLACKAMAS COUNTY SHERIFF
SCHOOL:	WEST LINN / WILSONVILLE SCHOOL DISTRICT 3JT
PARKS:	CITY OF WILSONVILLE
PHONE:	FRONTIER
WASTE DISPOSAL:	UNITED DISPOSAL SERVICE
CABLE:	COMCAST

BENCHMARK:

OREGON STATE PLANE COORDINATE 5818 LOCATED IN MONUMENT BOX IN CENTERLINE OF TOOZE ROAD .2 MILES WEST OF 110TH.

ELEVATION DATUM: NAVD 88, ELEVATION = 202.991

SHEET INDEX:

- 1 COVER SHEET
- 2 PHASING PLAN
- 3 EXISTING CONDITIONS
- 4 AERIAL PHOTOGRAPH
- 5 LAND USE KEY
- 6 LAND USE PLAN
- 7 CIRCULATION PLAN
- 8 STREET SECTIONS
- 9 PARK/OPEN SPACE/PATHWAYS PLAN
- 10 SROZ PLAN
- 11 STREET TREE PLAN
- 12.1 TREE PRESERVATION PLAN
- 12.2 TREE PRESERVATION PLAN PHASE 5N
- 13 GRADING PLAN
- 14 UTILITY PLAN

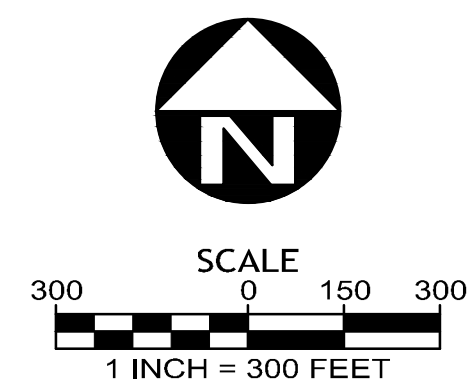

ELEVATION DATUM: NAVD 88



POLYGON NW COMPANY



GEODESIGN, INC

SAP NORTH
VILLEBOIS

Specific
Area Plan

Cover Sheet

City of Wilsonville
Exhibit B2 DB18-0049 et al

PROJECT NUMBER: 395-079

2ND SUBMITTAL DATE 9/28/2018

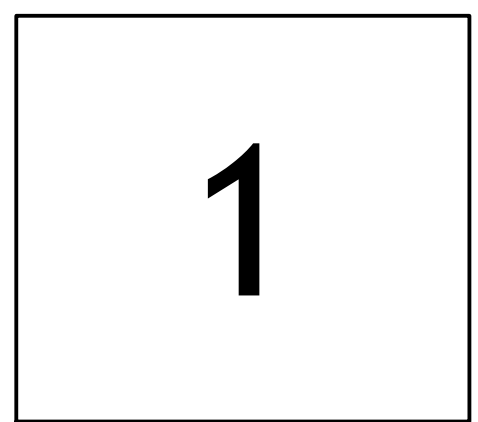

N:\proj\395-079\09 Drawings\03 Planning Sheets - Planning SAP Submittal\395079(2) PHASE.dwg - SHEET Layout1 Sep. 28. 18 - 10:38 AM jik

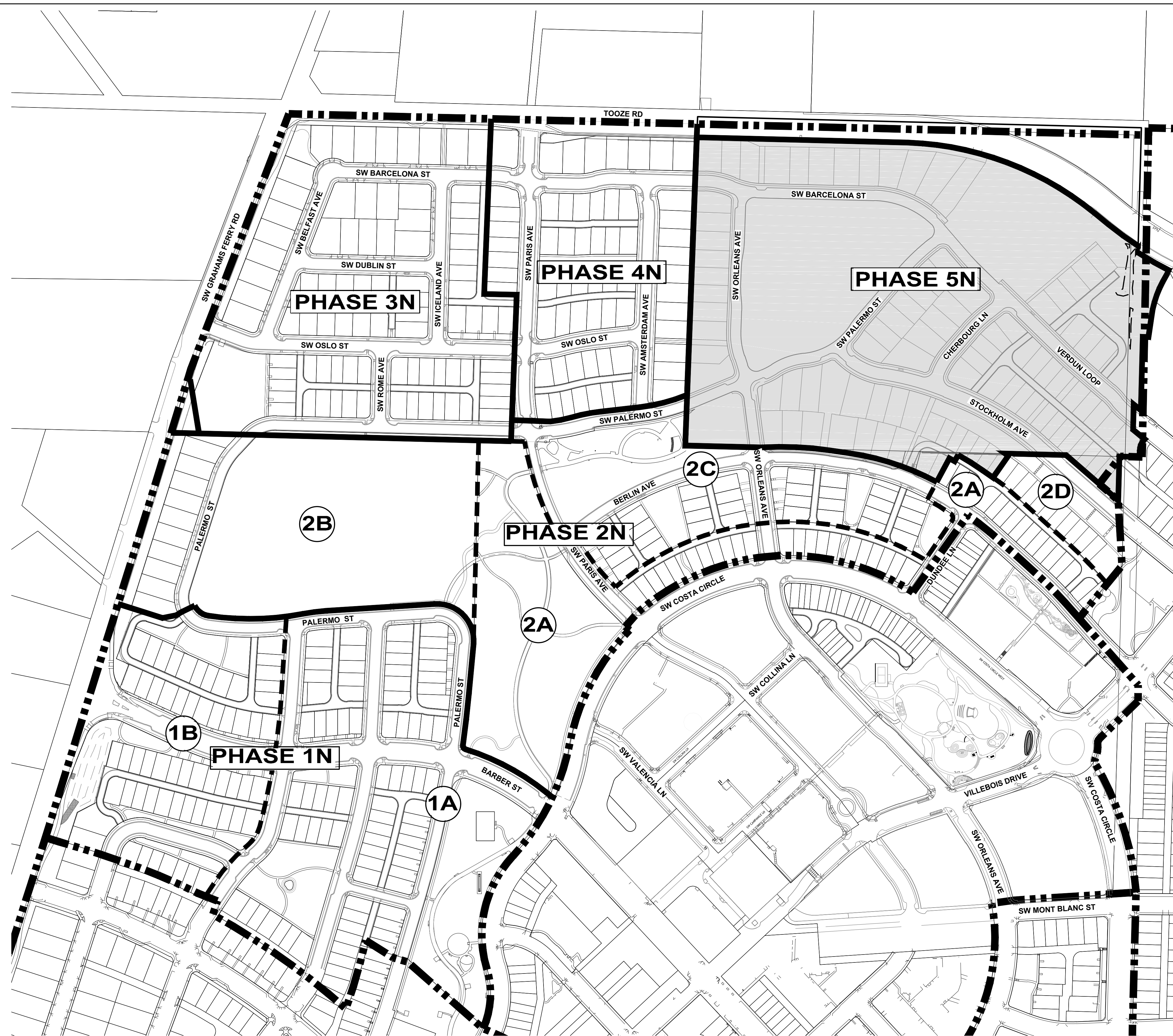

LEGEND:

- S.A.P. LINE
- S.A.P. PHASE LINE
- - - P.D.P. CONSTRUCTION PHASE LINE

PHASE 1N S.A.P. PHASE NUMBER

1A P.D.P. CONSTRUCTION PHASE NUMBER

PHASE 1N
 APPROVED 08/25/11
 DB11-0024 (PDP MODIFICATION)
 DB11-0025
 (SAP MODIFICATIONS & REFINEMENTS)

PHASE 2N
 APPROVED 06/11/13
 DB13-0020 (PDP)
 DB11-0025
 (SAP MODIFICATIONS & REFINEMENTS)

PHASE 3N
 APPROVED 5/12/14
 DB14-0011 (PDP)
 DB14-0012 & DB14-0013
 (SAP MODIFICATIONS, REFINEMENTS & AMENDMENTS)

PHASE 4N
 APPROVED 2/9/16
 DB15-0087 (PDP)
 DB15-0085 & DB15-0086
 (SAP MODIFICATIONS, REFINEMENTS & AMENDMENTS)

PHASE 5N
 PROPOSED



Villebois



POLYGON NW COMPANY



GEODESIGN, INC

SAP NORTH VILLEBOIS

Specific Area Plan

Phasing Plan

PROJECT NUMBER: 395-079
2ND SUBMITTAL DATE 9/28/2018

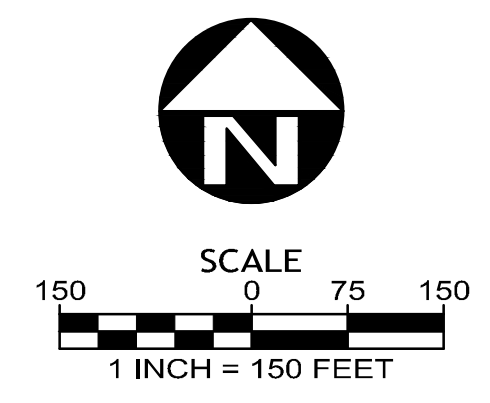

ELEVATION DATUM: NAVD 88

2

TAX MAP REFERENCE:
 TOWNSHIP 3 SOUTH, RANGE 1 WEST,
 SECTION 15, W.M., WILSONVILLE
 OREGON.

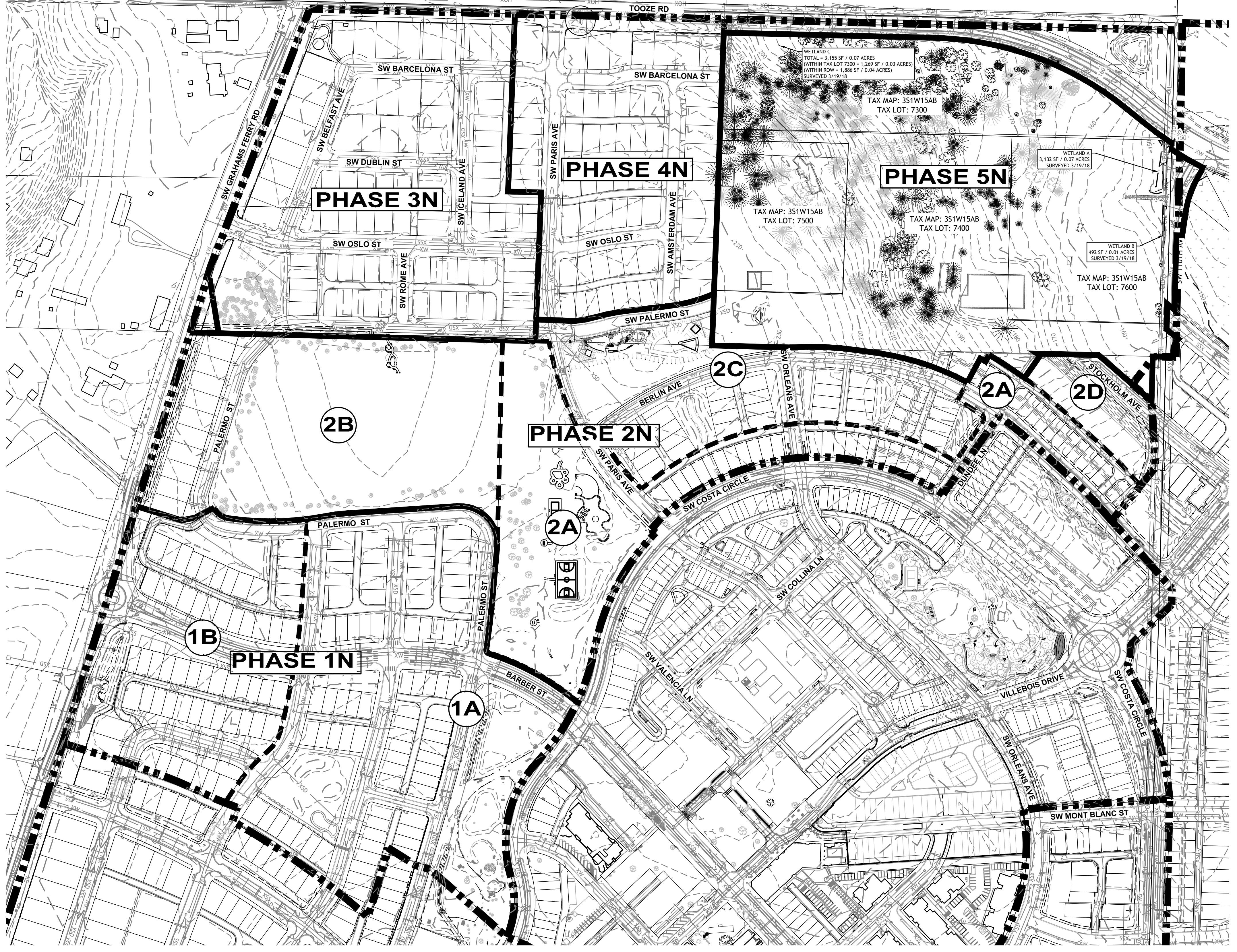

Villebois



POLYGON NW COMPANY



GEODESIGN, INC

SAP NORTH
 VILLEBOIS

Specific
 Area Plan

Existing
 Conditions

PROJECT NUMBER: 395-079
 2ND SUBMITTAL DATE: 9/28/2018

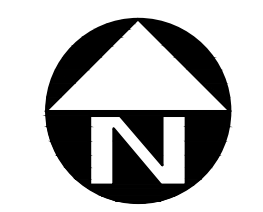

SCALE
 0 75 150
 1 INCH = 150 FEET

3

N:\proj\395-079\09 Drawings\03 Planning Sheets - Planning SAP Submittal\395079_03 EXIST.dwg - SHEET: Layout1 Sep. 28. 18 - 10:38 AM jlk

ELEVATION DATUM: NAVD 88

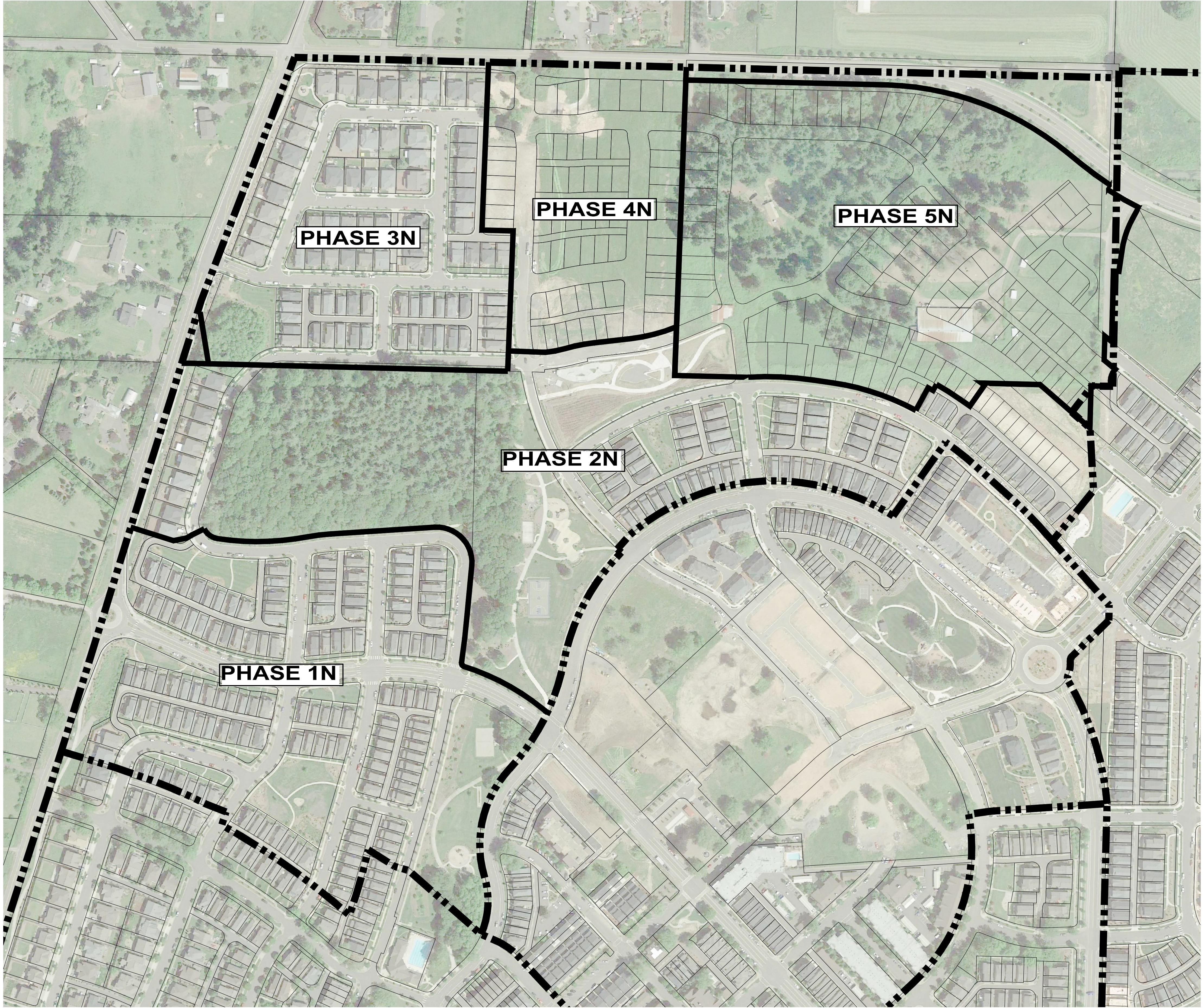

ELEVATION DATUM: NAVD 88

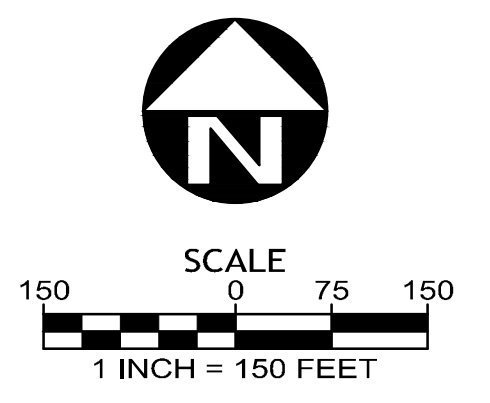

N:\proj\395-079\09 Drawings\03 Planning Sheets - Planning SAP Submittal\395079_41 AERIAL.dwg - SHEET.LAYOUT1 Sep. 28. 18 - 10:38 AM jlk



Villebois



POLYGON NW COMPANY



GEODESIGN, INC

SAP NORTH VILLEBOIS

Specific Area Plan

Aerial Photograph

PROJECT NUMBER: 395-079



2ND SUBMITTAL DATE: 9/28/2018

4

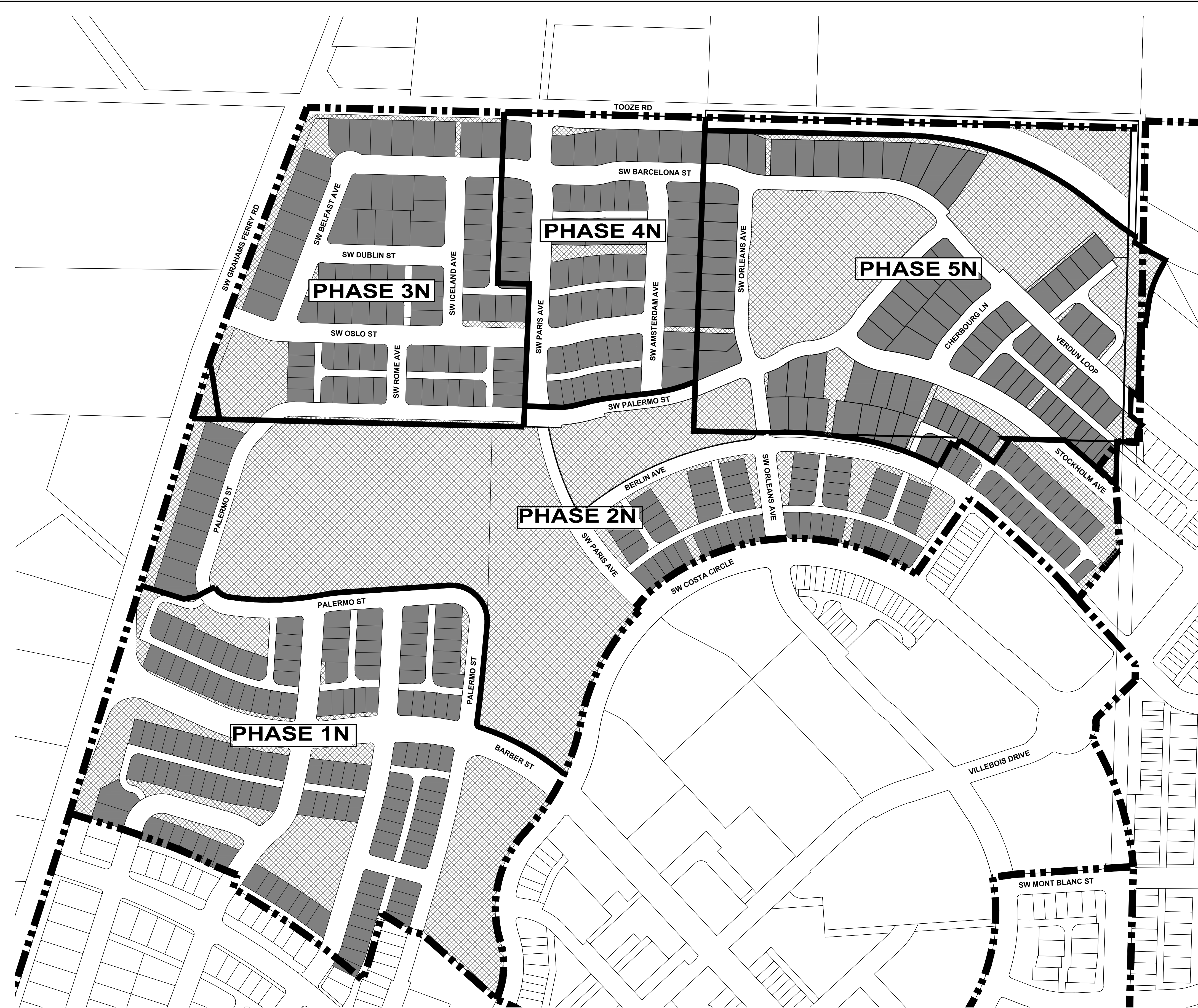
N:\proj\395-079\09 Drawings\03 Planning Sheets - Planning SAP Submittal\395079\5\ LAND KEY.dwg - SHEET: Layout1 Sep. 28. 18. 10:38 AM jfk

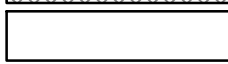

LEGEND:

-  RESIDENTIAL
-  PARK/OPEN SPACE
-  PUBLIC ROADS, PRIVATE ALLEYS



Villebois



POLYGON NW COMPANY



GEODESIGN, INC

SAP NORTH VILLEBOIS

Specific Area Plan

Land Use Key

PROJECT NUMBER: 395-079

2ND SUBMITTAL DATE: 9/28/2018

5

ELEVATION DATUM: NAVD 88

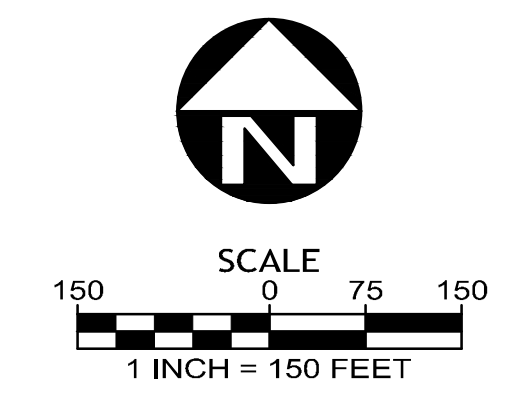



Villebois



POLYGON NW COMPANY



GEODESIGN, INC

SAP NORTH VILLEBOIS

Specific Area Plan

Land Use Plan

PROJECT NUMBER: 395-079

2ND SUBMITTAL DATE: 9/28/2018

6

LEGEND:

	SAP SOUTH BOUNDARY
RH	ROW HOME LOTS
SC	COTTAGE LOTS
SM	SMALL LOTS
STD	STANDARD LOTS
M	MEDIUM LOTS
L	LARGE LOTS
E	ESTATE LOTS
OS	OPEN SPACE
PARK	PARK SPACE
RP	REGIONAL PARK
PP	POCKET PARK
LG	LINEAR GREEN
OS	OPEN SPACE

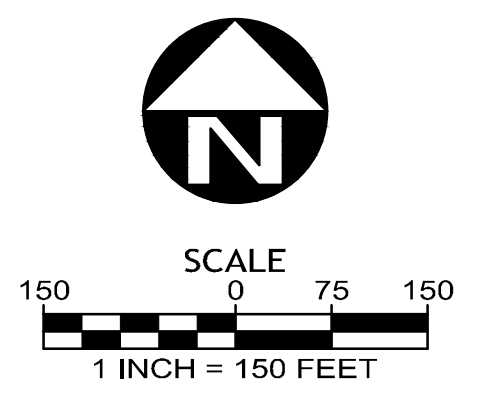
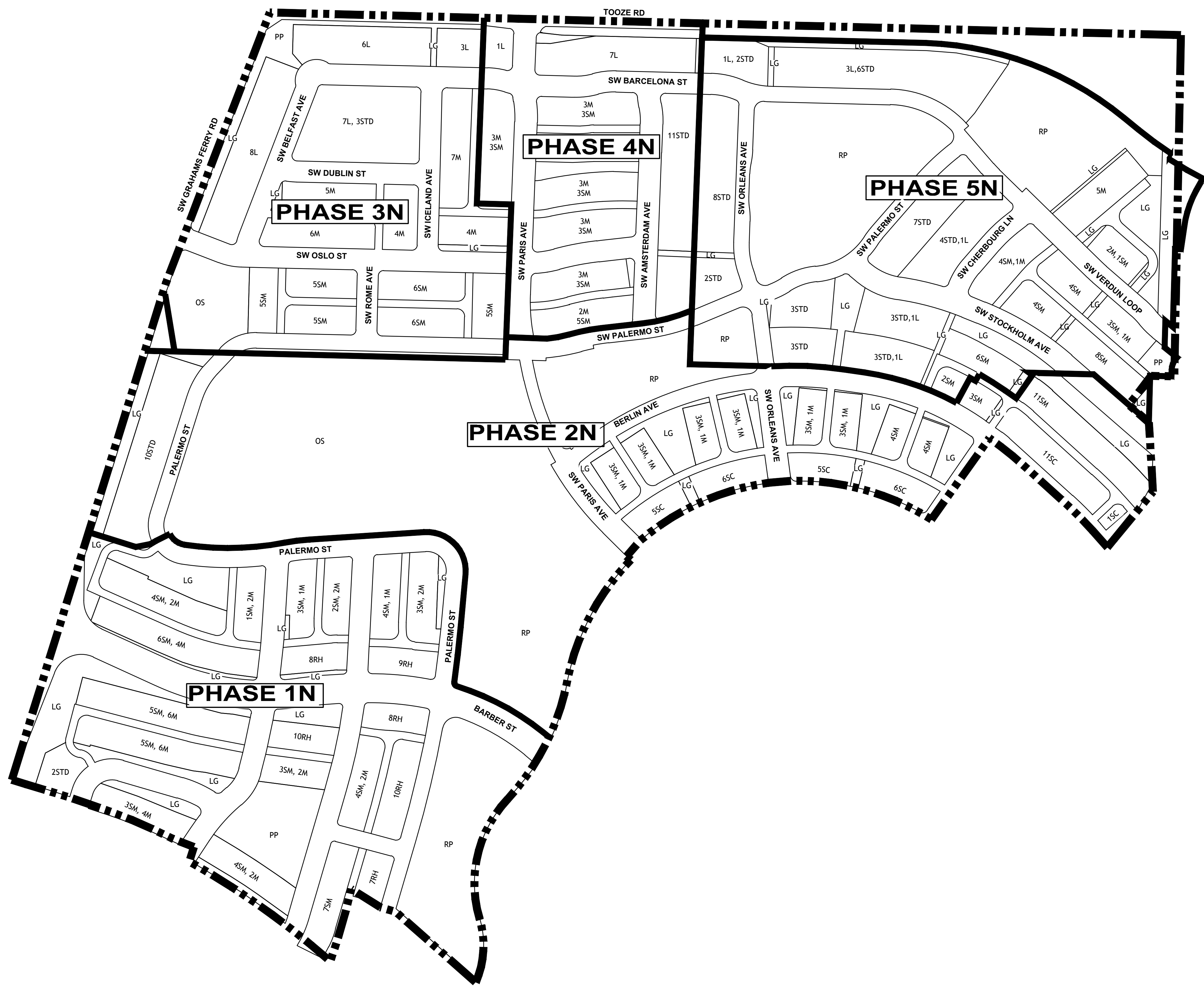

ELEVATION DATUM: NAVD 88

N:\proj\395-079\09 Drawings\03 Planning Sheets - Planning SAP Submittal\395079\6 LANDPLAN.dwg - SHEET: Layout1 Sep. 28. 18 - 10:39 AM jik

N:\proj\395-079\09 Drawings\03 Planning Sheets - Planning SAP Submittal\395079\71 CIRC.dwg - SHEET: Layout1 Sep. 28, 18 - 10:39 AM jlk

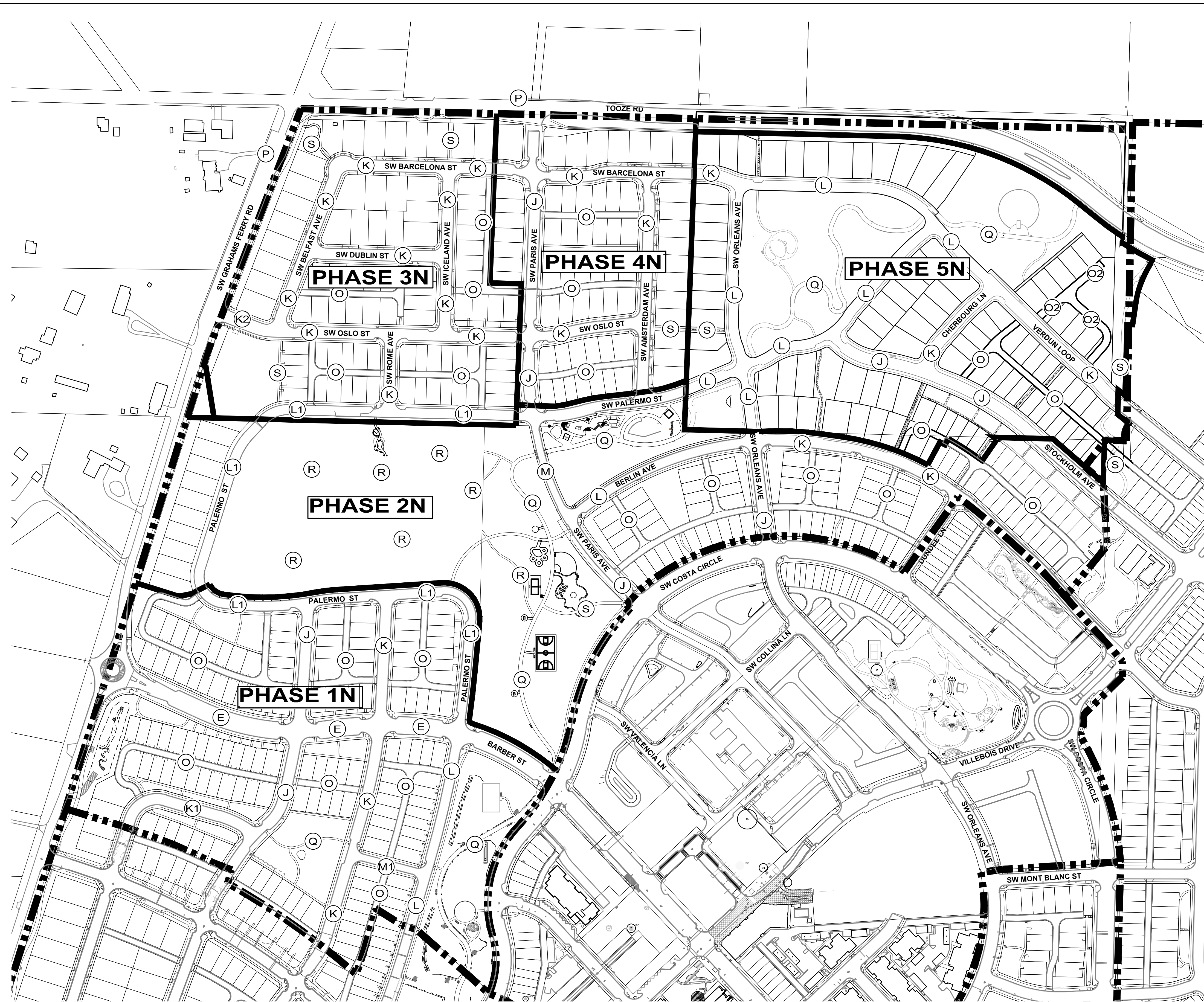

LEGEND:

(L) ROAD SECTION TYPE
SEE SHEET 8 FOR DETAILS

▬▬▬▬▬ SAP NORTH

ELEVATION DATUM: NAVD 88

SCALE
0 75 150
1 INCH = 150 FEET



Villebois



POLYGON NW COMPANY



GEODESIGN, INC

SAP NORTH
VILLEBOIS

Specific
Area Plan

Circulation
Plan

PROJECT NUMBER: 395-079

2ND SUBMITTAL DATE: 9/28/2018

7



Villebois



POLYGON NW COMPANY



GEODESIGN, INC

SAP NORTH VILLEBOIS

Specific Area Plan

Street Sections

PROJECT NUMBER: 395-079
2ND SUBMITTAL DATE: 9/28/2018

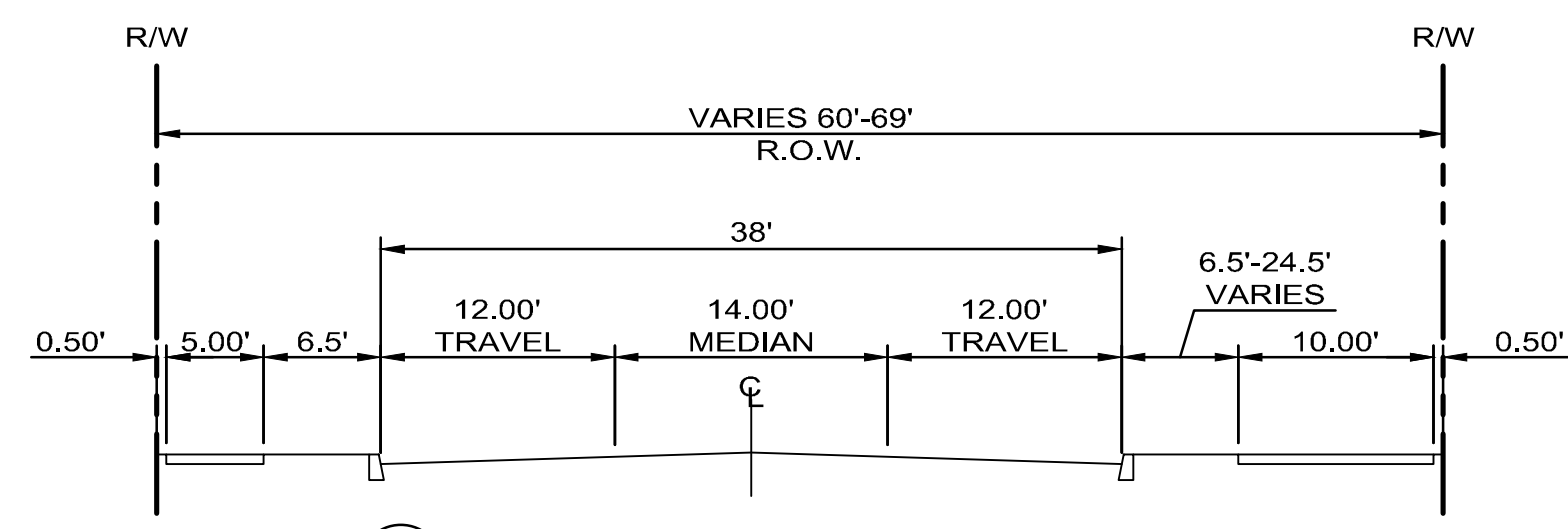

P MINOR ARTERIAL
NTS

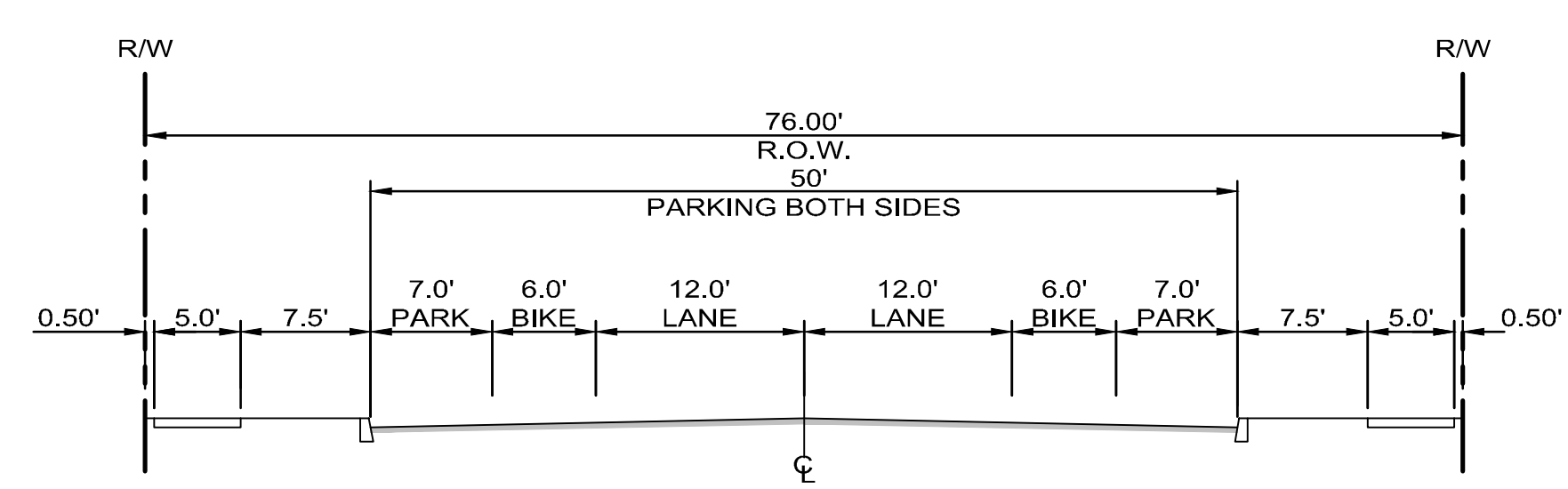

E MINOR COLLECTOR
NTS

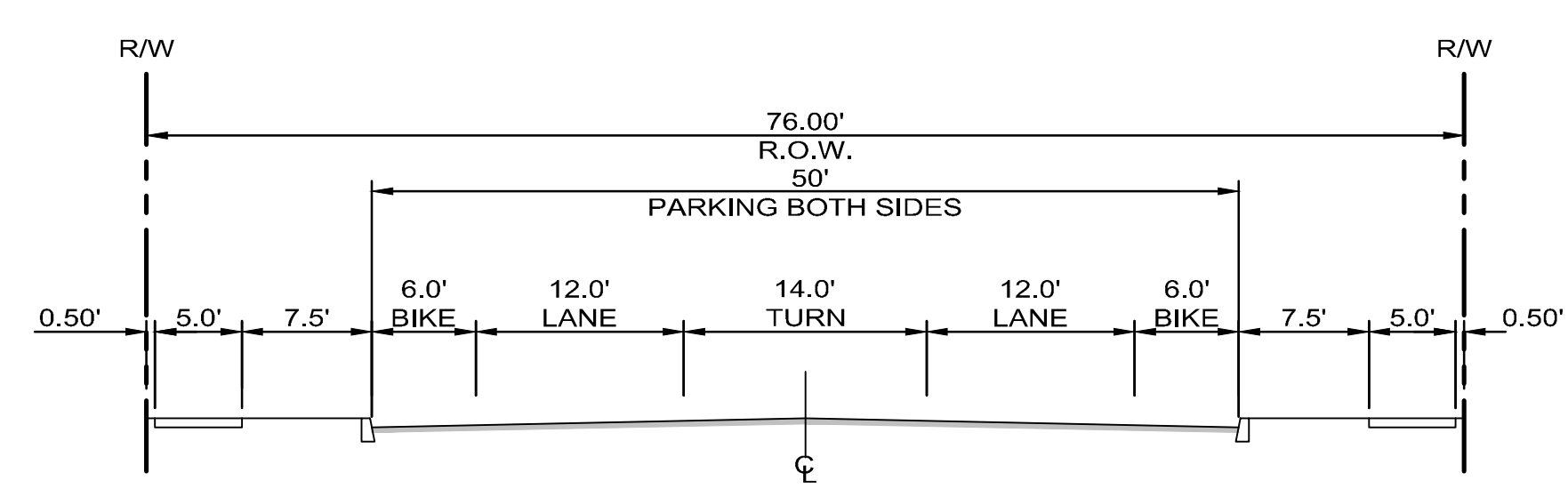

E1 MINOR COLLECTOR W/LEFT TURN POCKET
NTS

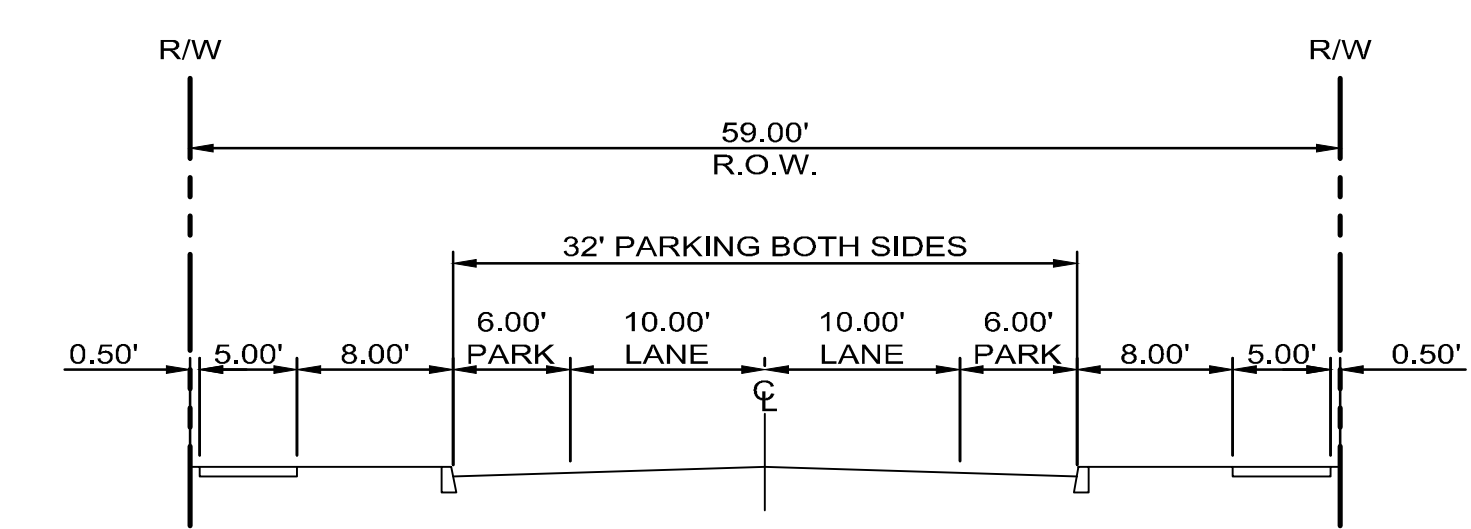

J RESIDENTIAL-STANDARD
NTS

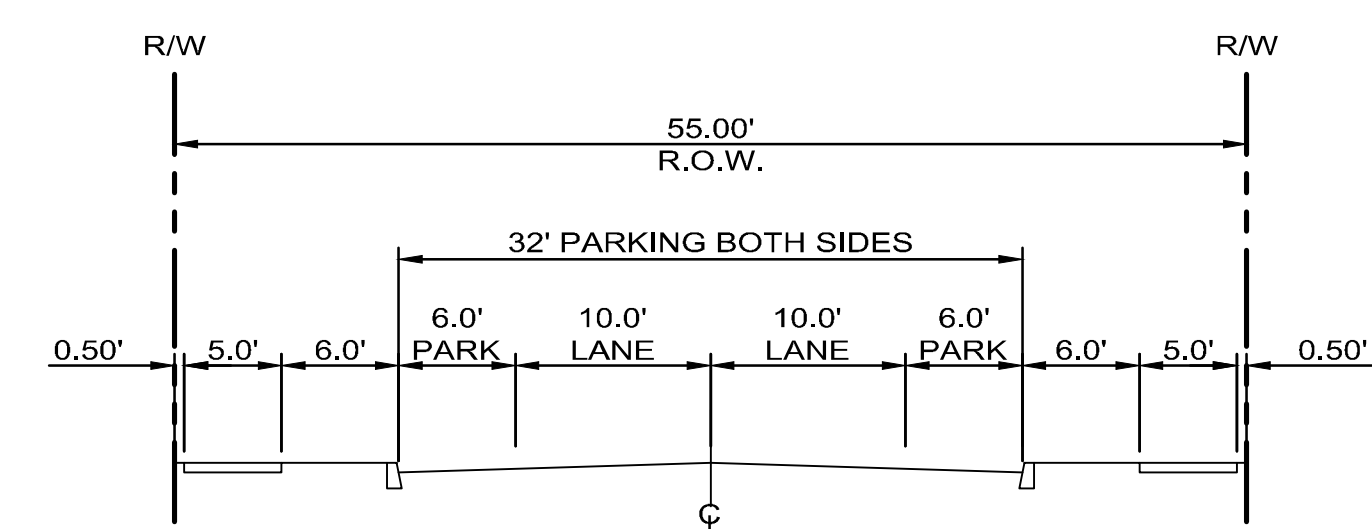

K RESIDENTIAL-MINIMUM
NTS

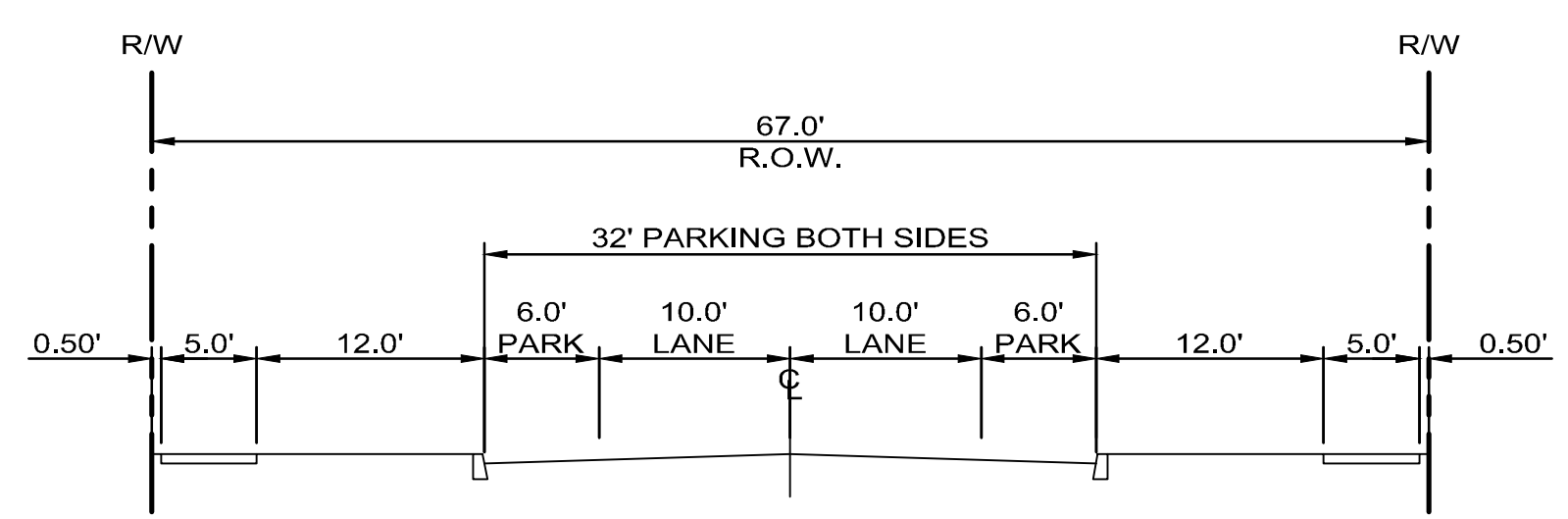

K1 RESIDENTIAL-MINIMUM
NTS

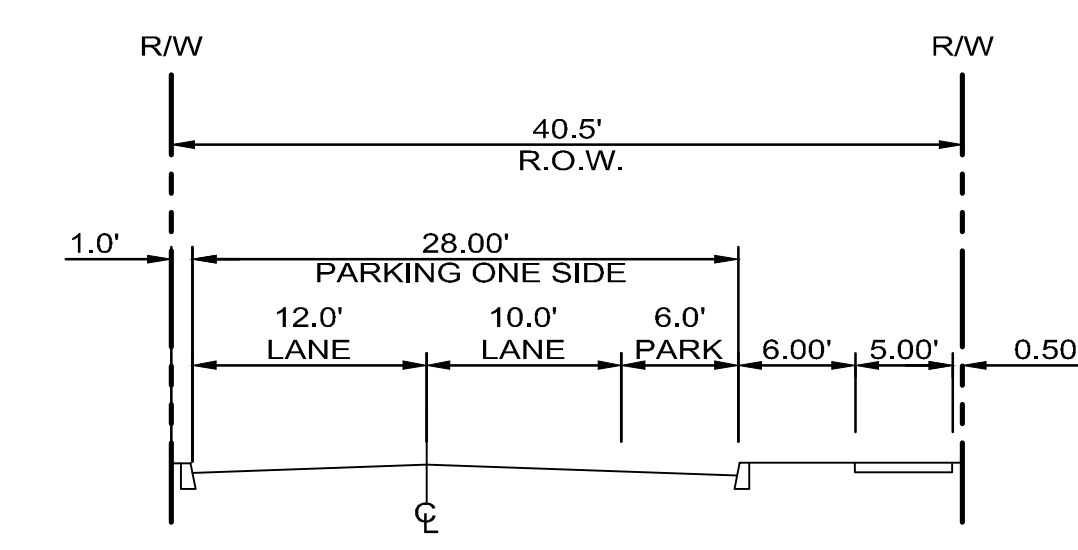

L RESIDENTIAL
PARKING ONE SIDE
NTS

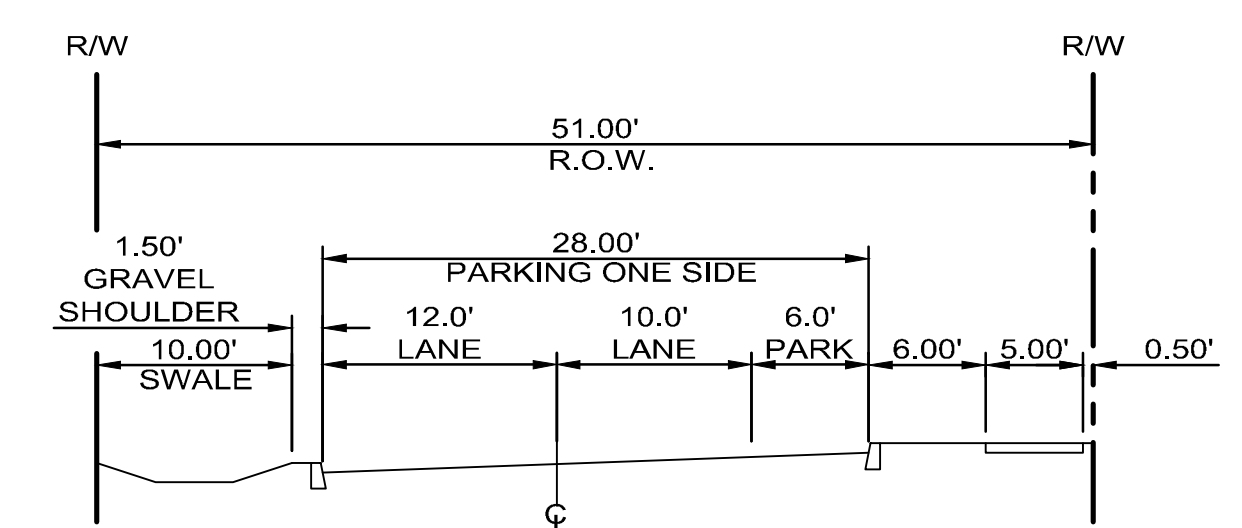

L1 RESIDENTIAL
PARKING ONE SIDE
NTS

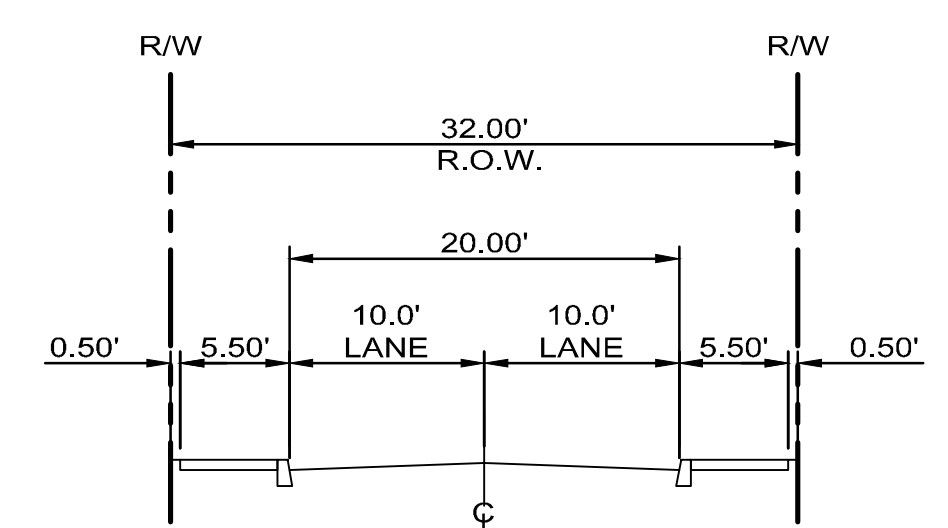

M RESIDENTIAL - NO
PARKING
NTS

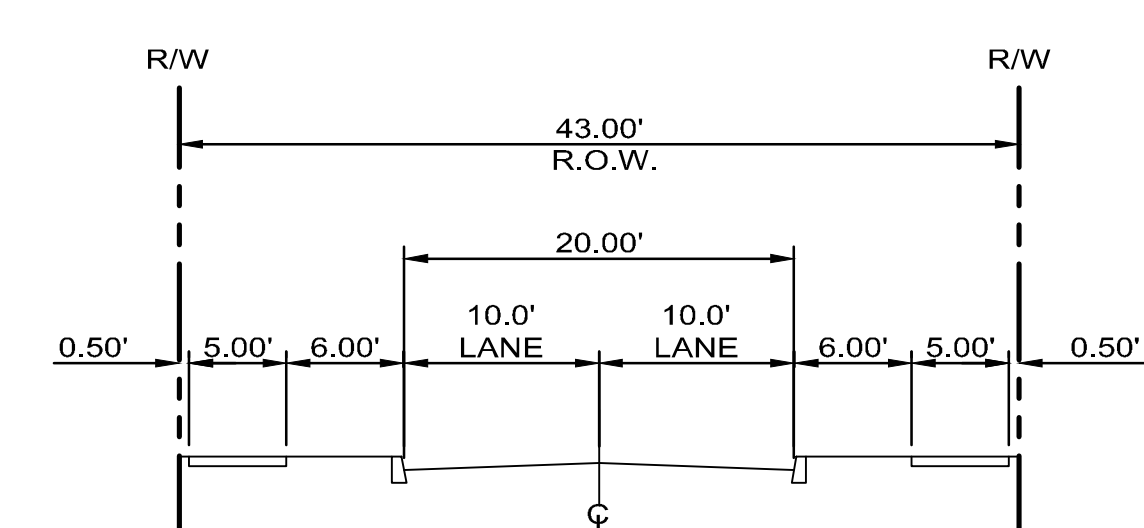

M1 RESIDENTIAL - NO
PARKING
NTS

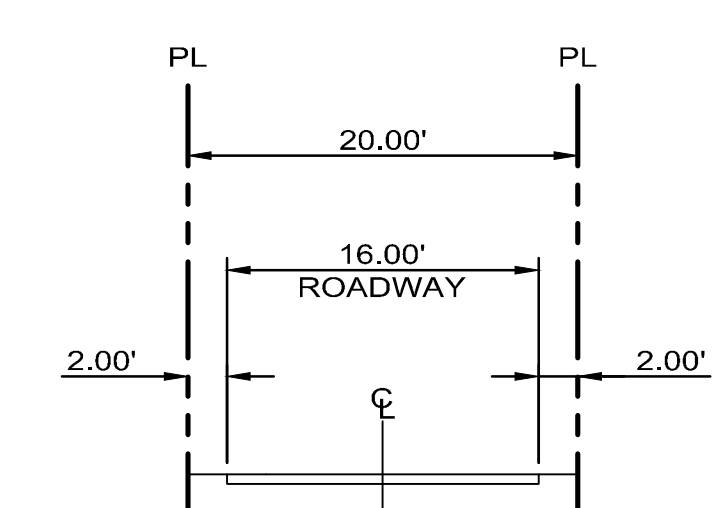

O PRIVATE LANE
NTS

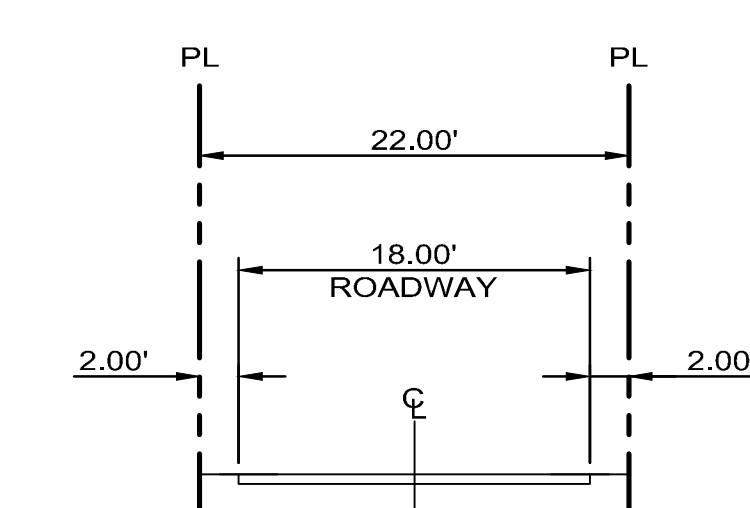

O2 PRIVATE LANE
NTS

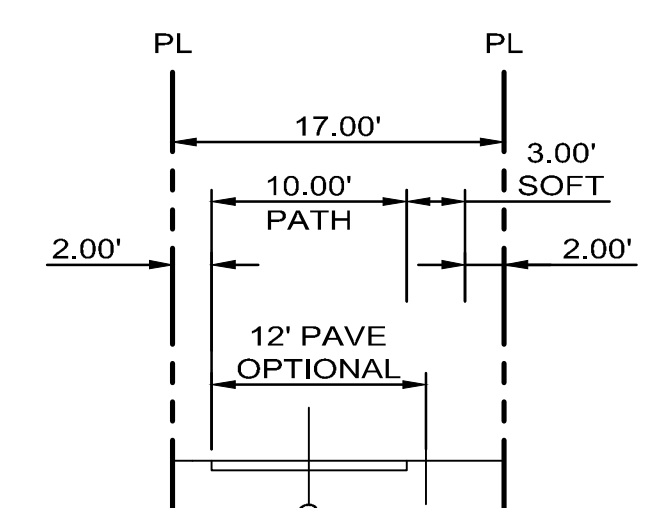

Q MAJOR PATHWAY
NTS

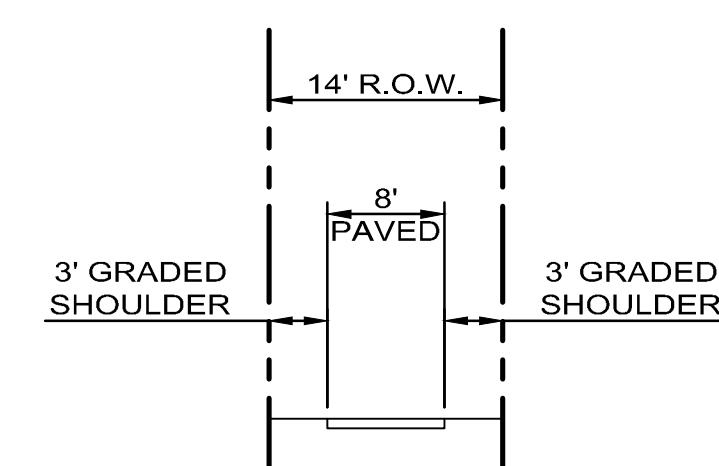

S MINOR PATHWAY
NTS

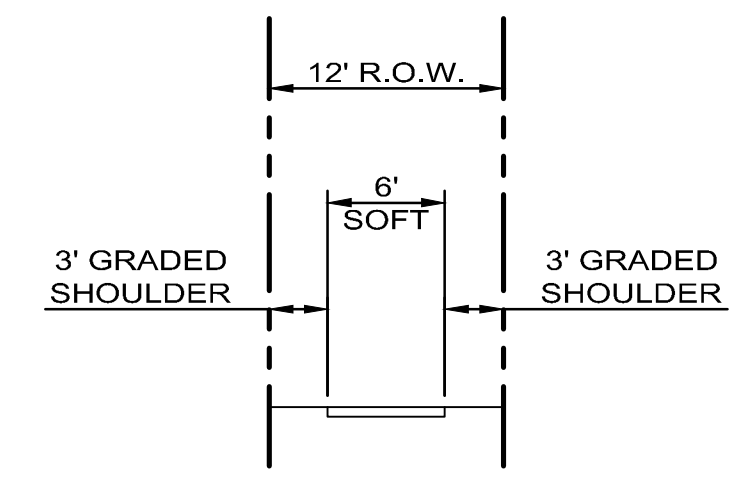

R NATURE PATHWAY
NTS

N:\proj\395-079\09 Drawings\03 Planning Sheets - Planning SAP Submittal\395079 (8) SECT.dwg - SHEET: Layout1 Sep. 28. 18. - 10:39 AM jlk

ELEVATION DATUM: NAVD 88

N:\proj\395-079\09 Drawings\03 Planning Sheets - Planning SAP Submittal\395079 (9) PARK.dwg - SHEET: Layout1 Sep, 28, 18 - 10:40 AM jlk

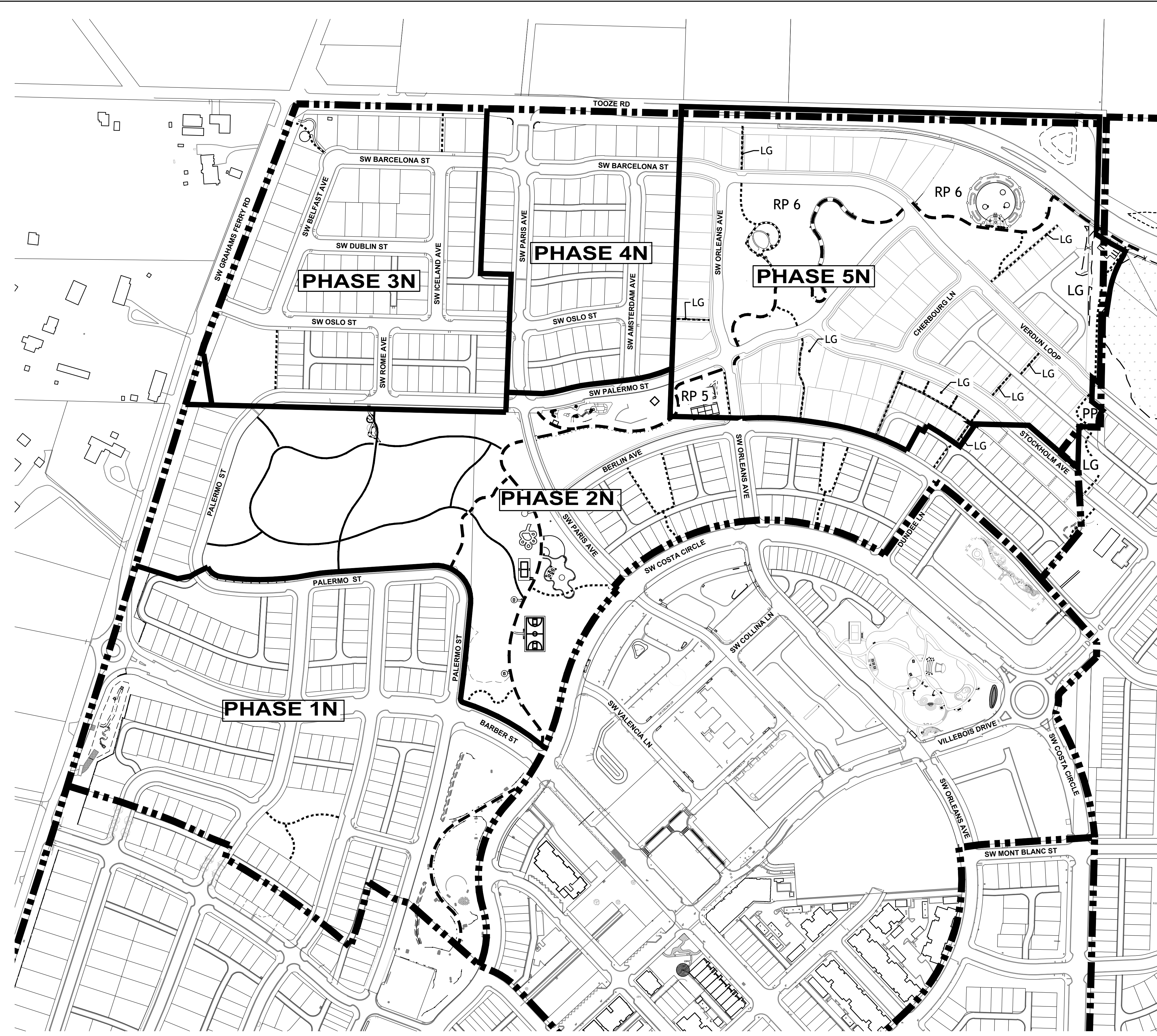

ELEVATION DATUM: NAVD 88

LEGEND:

- MAJOR PATHWAYS
- MINOR PATHWAYS
- NATURE TRAILS

RP-3
 Within SAP North, Regional Park component 3 includes a child play structure, a creative play area, a volleyball court, a large lawn area (200'x140'), benches, picnic tables, and may have stormwater / rainwater features.

RP-4 (6.14 acres)
 Regional Park component 4 is contiguous to the Upland Forest Preserve (OS-2). The Villebois Loop Trail traverses the park. This park includes a creative play area, a basketball court, a multipurpose sport court, and a large lawn area (160'x300'). In addition, the park includes a shelter with a barbecue, benches, picnic tables, a drinking fountain, and may have stormwater / rainwater features.

RP-5 (2.24 acres)
 Regional Park component 5 is located south of the approximately 10-acre City-owned parcel. Planning for the park includes a neighborhood commons area with a skate plaza, a transit stop, restrooms, picnic tables, benches, a barbecue, shelter, play structure, an overlook view to Mt. Hood, a drinking fountain, water feature, a lawn area (100'x500'), and may include a stormwater / rainwater feature.

RP-6 (5.93 acres)
 Regional Park component 6 preserves several large groves of trees while also providing active and passive recreation opportunities. The park includes a two tennis court facility, a child play structure, a dog park, picnic tables, benches, a minor water feature and may include stormwater/rainwater features.

OS-2: Upland Forest Preserve (10.60 acres)
 This site is dominated by a large grove of conifer with some deciduous trees mixed in. The Villebois plan advocates removal of invasive species within this area (any work or impacts within the upland forest area shall comply with SROZ regulations). The forest is contiguous with the Villebois Greenway and the Villebois Loop Trail's Tonquin segment. Smaller soft-surface nature trails will meander through the forest and link neighborhoods on either side. This second-growth forest ecosystem will act as a habitat patch, valuable to small mammals, invertebrates and birds. Along the nature trails two benches for wildlife viewing and quiet contemplation will complement the undeveloped nature of this open space. Picnic tables, and a child play structure will provide recreation opportunities while complementing the existing site features.

Pocket Parks (PP)
 Small open spaces, or pocket parks, will be interspersed throughout the Villebois community. These spaces will incorporate important existing trees and provide recreational opportunities for residents. These open spaces will provide areas for community use that are convenient while helping to serve as a buffer between adjoining uses.

Linear Greens (LG)
 Linear Greens are small park areas that provide connectivity among parks and through blocks. Linear Greens include trails.

Nature Trails - Soft-surface trails within natural open spaces.

Minor Pathways - Pedestrian and bicycle connections between neighborhoods, traversing parks and linear greens.

Major Pathways - The Tonquin Trail, the Villebois Loop Trail, and the Coffee Lake-Wood Trail

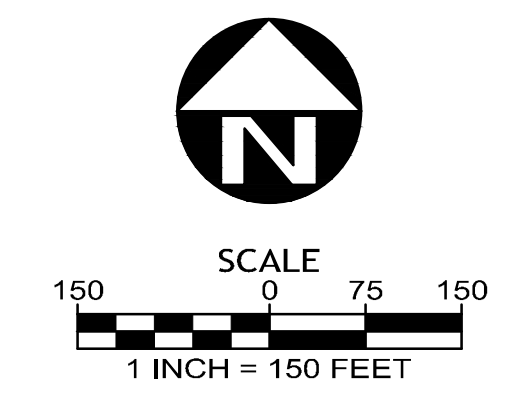

Villebois



POLYGON NW COMPANY



GEODESIGN, INC

SAP NORTH
 VILLEBOIS

Specific
 Area Plan

Park /
 Open Space /
 Pathways Plan

PROJECT NUMBER: 395-079
 2ND SUBMITTAL DATE 9/28/2018

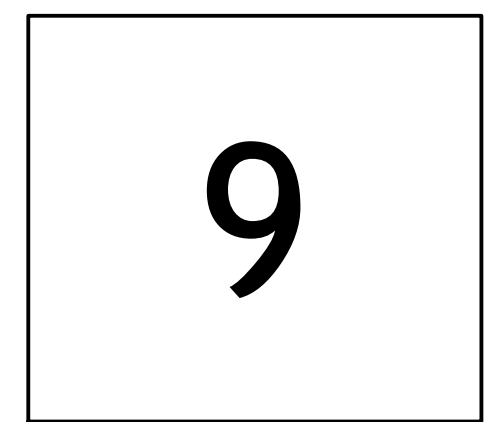



Villebois



POLYGON NW COMPANY



GEODESIGN, INC

SAP NORTH VILLEBOIS

Specific Area Plan

SROZ Plan

PROJECT NUMBER: 395-079

2ND SUBMITTAL DATE 9/28/2018

10

SROZ ENCROACHMENTS AND MITIGATION

AREA OF LIMITED CONFLICT USE	430,988 SF
TOTAL AREA OF IMPACT PREVIOUSLY APPROVED	18,356 SF = 4.3%
PDP 5N AREAS OF IMPACT	0 SF
ADJUSTED TOTAL IMPACT AREA	18,356 SF = 4.3%
ADJUSTED MITIGATION AREA REQUIRED AT 2.5:1 RATIO	45,890 SF
PREVIOUSLY APPROVED MITIGATION AREA TO BE PROVIDED	46,212 SF

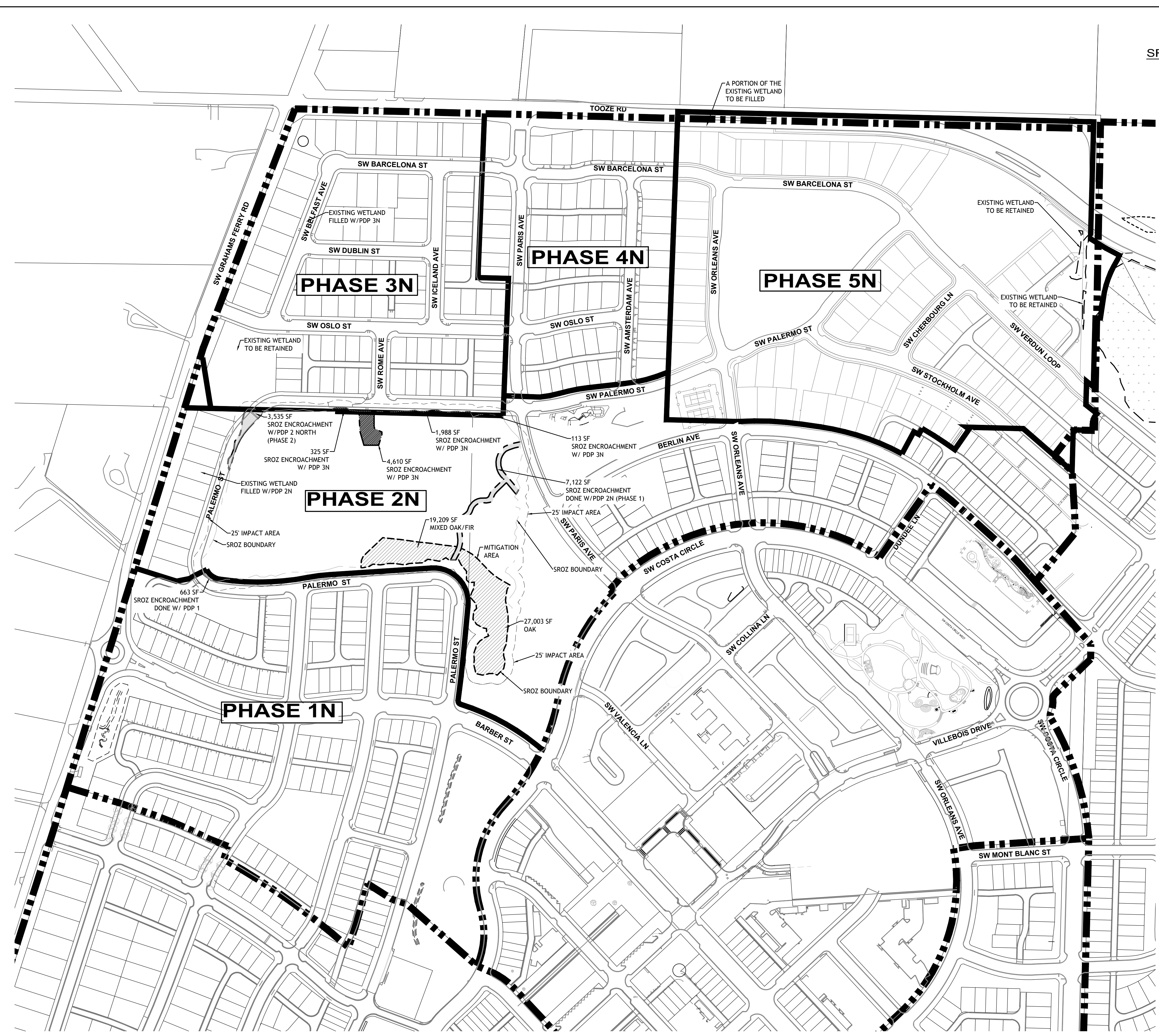

ELEVATION DATUM: NAVD 88

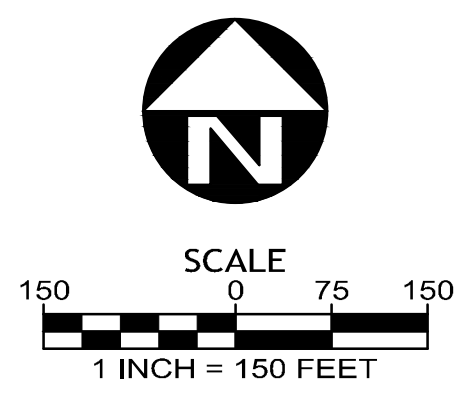

N:\proj\395-079\09 Drawings\03 Planning Sheets - Planning SAP Submittal\395079_10 SROZ.dwg - SHEET: Layout1 Sep. 28. 18 - 10:40 AM jlk

N:\proj\395-079\09 Drawings\03 Planning Sheets - Planning SAP Submittal\395079_111 STREETTREE.dwg - SHEET Layout1 Sep. 28. 18 - 10:40 AM jlk

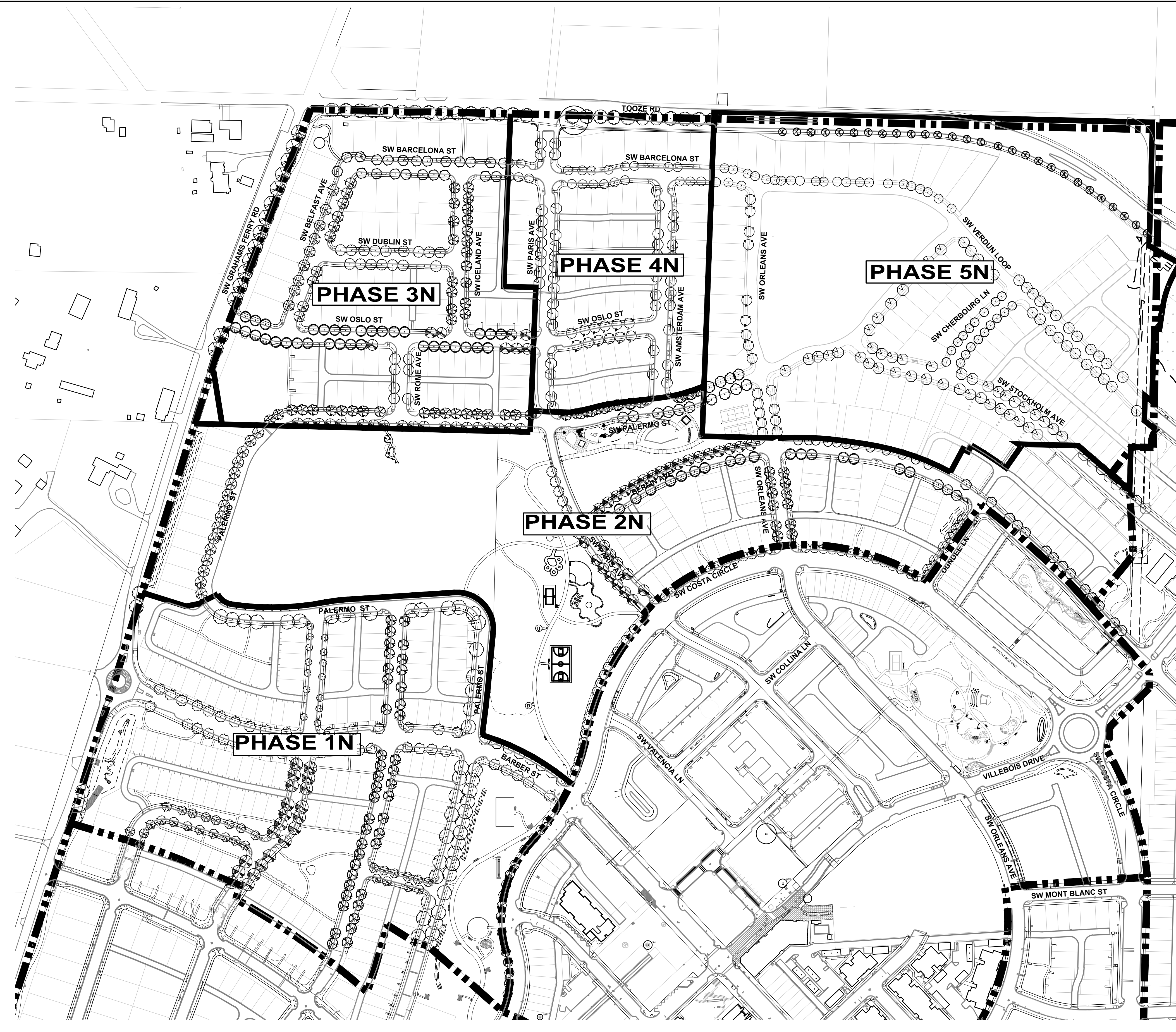

STREET TREE LEGEND: PHASE 1

SYMBOL	BOTANICAL NAME Common Name	SIZE	SPACING
	QUERCUS ALBA White Oak	2" cal.	30' o.c.
	LIRIODENDRON TULIPIFERA Tulip Tree	2" cal.	30' o.c.
	ACER x FREEMANNI 'AUTUMN BLAZE' Autumn Blaze Maple	2" cal.	30' o.c.
	TILIA x EUCLORA Crimean Linden	2" cal.	30' o.c.
	ACER RUBRUM 'RED SUNSET' Red Sunset Maple	2" cal.	30' o.c.
	ZELKOVA SERR. 'VILLAGE GREEN' Tulip Tree	2 1/2" cal.	35' o.c.
	CORNUS FLORIDA Flowering Dogwood	2" cal.	30' o.c.
	FAGUS SYLVATICA European Beech	2 1/2" cal.	40' o.c.

STREET TREE LEGEND: PHASE 2

SYMBOL	BOTANICAL NAME Common Name	SIZE	SPACING
	ACER x FREEMANNI 'AUTUMN BLAZE' Autumn Blaze Maple	2" cal.	30' o.c.
	CLADRASTIS KENTUKEA Yellowwood	2" cal.	30' o.c.
	FAGUS SYLVATICA European Beech	2" cal.	30' o.c.
	LIRIODENDRON TULIPIFERA Tulip Tree	2 1/2" cal.	25' o.c.
	QUERCUS ALBA White Oak	2" cal.	30' o.c.
	AESCOLLUS x CARNEA 'BRIOTTI' Red Horsechestnut	2" cal.	30' o.c.
	QUERCUS ALBA White Oak	2" cal.	30' o.c.
	ZELKOVA SERRATA 'GREEN VASE' Green Vase Zelkova	2" cal.	30' o.c.
	QUERCUS PALUSTRIS Pin Oak	2" cal.	30' o.c.

STREET TREE LEGEND: PHASE 3

SYMBOL	BOTANICAL NAME Common Name	SIZE	SPACING
	ACER x FREEMANNI 'AUTUMN BLAZE' Autumn Blaze Maple	2" cal.	30' o.c.
	ACER PSEUDOPLANTANUS Sycamore Maple	2" cal.	30' o.c.
	FAGUS SYLVATICA European Beech	2" cal.	30' o.c.
	NYSSA SYLVATICA Black Tupelo	2" cal.	30' o.c.
	QUERCUS COCCINEA Scarlett Oak	2" cal.	30' o.c.
	QUERCUS RUBRA White Oak	2 1/2" cal.	40' o.c.
	TILIA TOMENTOSA Silver Linden	2 1/2" cal.	40' o.c.
	ZELKOVA SERRATA 'GREEN VASE' Green Vase Zelkova	2" cal.	30' o.c.

STREET TREE LEGEND: PHASE 4

SYMBOL	BOTANICAL NAME / Common Name	SIZE	SPACING
	ACER x FREEMANNI 'AUTUMN BLAZE' Autumn Blaze Maple	2" cal., B&B	30' o.c.
	FAGUS SYLVATICA European Beech	2" cal., B&B	30' o.c.
	QUERCUS ROBUR English Oak	2" cal., B&B	30' o.c.
	ACER PSEUDOPLANTANUS Sycamore Maple	2" cal., B&B	30' o.c.
	CRATAEGUS VIRDIS 'WINTER KING' Winter King Hawthorne	2" cal., B&B	30' o.c.

STREET TREE LEGEND: PHASE 5

SYMBOL	BOTANICAL NAME Common Name	SIZE	SPACING
	ACER x FREEMANNI 'AUTUMN BLAZE' Autumn Blaze Maple	2" cal.	30' o.c.
	ACER PSEUDOPLANTANUS Sycamore Maple	2" cal.	30' o.c.
	FAGUS SYLVATICA European Beech	2" cal.	30' o.c.
	NYSSA SYLVATICA Black Tupelo	2" cal.	30' o.c.
	QUERCUS COCCINEA Scarlett Oak	2" cal.	30' o.c.
	QUERCUS RUBRA White Oak	2 1/2" cal.	40' o.c.
	TILIA TOMENTOSA Silver Linden	2 1/2" cal.	40' o.c.
	ZELKOVA SERRATA 'GREEN VASE' Green Vase Zelkova	2" cal.	30' o.c.

STREET TREE LEGEND: PHASE 1

SYMBOL	BOTANICAL NAME Common Name	SIZE	SPACING
	QUERCUS ALBA White Oak	2" cal.	30' o.c.
	LIRIODENDRON TULIPIFERA Tulip Tree	2" cal.	30' o.c.
	ACER x FREEMANNI 'AUTUMN BLAZE' Autumn Blaze Maple	2" cal.	30' o.c.
	TILIA x EUCLORA Crimean Linden	2" cal.	30' o.c.
	ACER RUBRUM 'RED SUNSET' Red Sunset Maple	2" cal.	30' o.c.
	ZELKOVA SERR. 'VILLAGE GREEN' Tulip Tree	2 1/2" cal.	35' o.c.
	CORNUS FLORIDA Flowering Dogwood	2" cal.	30' o.c.
	FAGUS SYLVATICA European Beech	2 1/2" cal.	40' o.c.

STREET TREE LEGEND: PHASE 2

SYMBOL	BOTANICAL NAME Common Name	SIZE	SPACING
	ACER x FREEMANNI 'AUTUMN BLAZE' Autumn Blaze Maple	2" cal.	30' o.c.
	CLADRASTIS KENTUKEA Yellowwood	2" cal.	30' o.c.
	FAGUS SYLVATICA European Beech	2" cal.	30' o.c.
	LIRIODENDRON TULIPIFERA Tulip Tree	2 1/2" cal.	25' o.c.
	QUERCUS ALBA White Oak	2" cal.	30' o.c.
	AESCOLLUS x CARNEA 'BRIOTTI' Red Horsechestnut	2" cal.	30' o.c.
	QUERCUS ALBA White Oak	2" cal.	30' o.c.
	ZELKOVA SERRATA 'GREEN VASE' Green Vase Zelkova	2" cal.	30' o.c.
	QUERCUS PALUSTRIS Pin Oak	2" cal.	30' o.c.

STREET TREE LEGEND: PHASE 3

SYMBOL	BOTANICAL NAME Common Name	SIZE	SPACING
	ACER x FREEMANNI 'AUTUMN BLAZE' Autumn Blaze Maple	2" cal.	30' o.c.
	ACER PSEUDOPLANTANUS Sycamore Maple	2" cal.	30' o.c.
	FAGUS SYLVATICA European Beech	2" cal.	30' o.c.
	NYSSA SYLVATICA Black Tupelo	2" cal.	30' o.c.
	QUERCUS COCCINEA Scarlett Oak	2" cal.	30' o.c.
	QUERCUS RUBRA White Oak	2 1/2" cal.	40' o.c.
	TILIA TOMENTOSA Silver Linden	2 1/2" cal.	40' o.c.
	ZELKOVA SERRATA 'GREEN VASE' Green Vase Zelkova	2" cal.	30' o.c.

STREET TREE LEGEND: PHASE 4

SYMBOL	BOTANICAL NAME / Common Name	SIZE	SPACING
	ACER x FREEMANNI 'AUTUMN BLAZE' Autumn Blaze Maple	2" cal., B&B	30' o.c.
	FAGUS SYLVATICA European Beech	2" cal., B&B	30' o.c.
	QUERCUS ROBUR English Oak	2" cal., B&B	30' o.c.
	ACER PSEUDOPLANTANUS Sycamore Maple	2" cal., B&B	30' o.c.
	CRATAEGUS VIRDIS 'WINTER KING' Winter King Hawthorne	2" cal., B&B	30' o.c.

STREET TREE LEGEND: PHASE 5

SYMBOL	BOTANICAL NAME Common Name	SIZE	SPACING
	ACER x FREEMANNI 'AUTUMN BLAZE' Autumn Blaze Maple	2" cal.	30' o.c.
	ACER PSEUDOPLANTANUS Sycamore Maple	2" cal.	30' o.c.
	FAGUS SYLVATICA European Beech	2" cal.	30' o.c.
	NYSSA SYLVATICA Black Tupelo	2" cal.	30' o.c.
	QUERCUS COCCINEA Scarlett Oak	2" cal.	30' o.c.
	QUERCUS RUBRA White Oak	2 1/2" cal.	40' o.c.
	TILIA TOMENTOSA Silver Linden	2 1/2" cal.	40' o.c.
	ZELKOVA SERRATA 'GREEN VASE' Green Vase Zelkova	2" cal.	30' o.c.

STREET TREE LEGEND: PHASE 1

SYMBOL	BOTANICAL NAME Common Name	SIZE	SPACING
	QUERCUS ALBA White Oak	2" cal.	30' o.c.
	LIRIODENDRON TULIPIFERA Tulip Tree	2" cal.	30' o.c.
	ACER x FREEMANNI 'AUTUMN BLAZE' Autumn Blaze Maple	2" cal.	30' o.c.
	TILIA x EUCLORA Crimean Linden	2" cal.	30' o.c.
	ACER RUBRUM 'RED SUNSET' Red Sunset Maple	2" cal.	30' o.c.
	ZELKOVA SERR. 'VILLAGE GREEN' Tulip Tree	2 1/2" cal.	35' o.c.
	CORNUS FLORIDA Flowering Dogwood	2" cal.	30' o.c.
	FAGUS SYLVATICA European Beech	2 1/2" cal.	40' o.c.



ELEVATION DATUM: NAVD 88



GEODESIGN, INC

SAP NORTH VILLEBOIS

Specific Area Plan

Street Tree Plan

PROJECT NUMBER: 395-079
2ND SUBMITTAL DATE: 9/28/2018

N:\proj\395-079\09 Drawings\03 Planning Sheets - Planning SAP Submittal\395079_12.1\TREPRES.dwg - SHEET: Layout1 Sep. 28. 18 - 10:41 AM jk

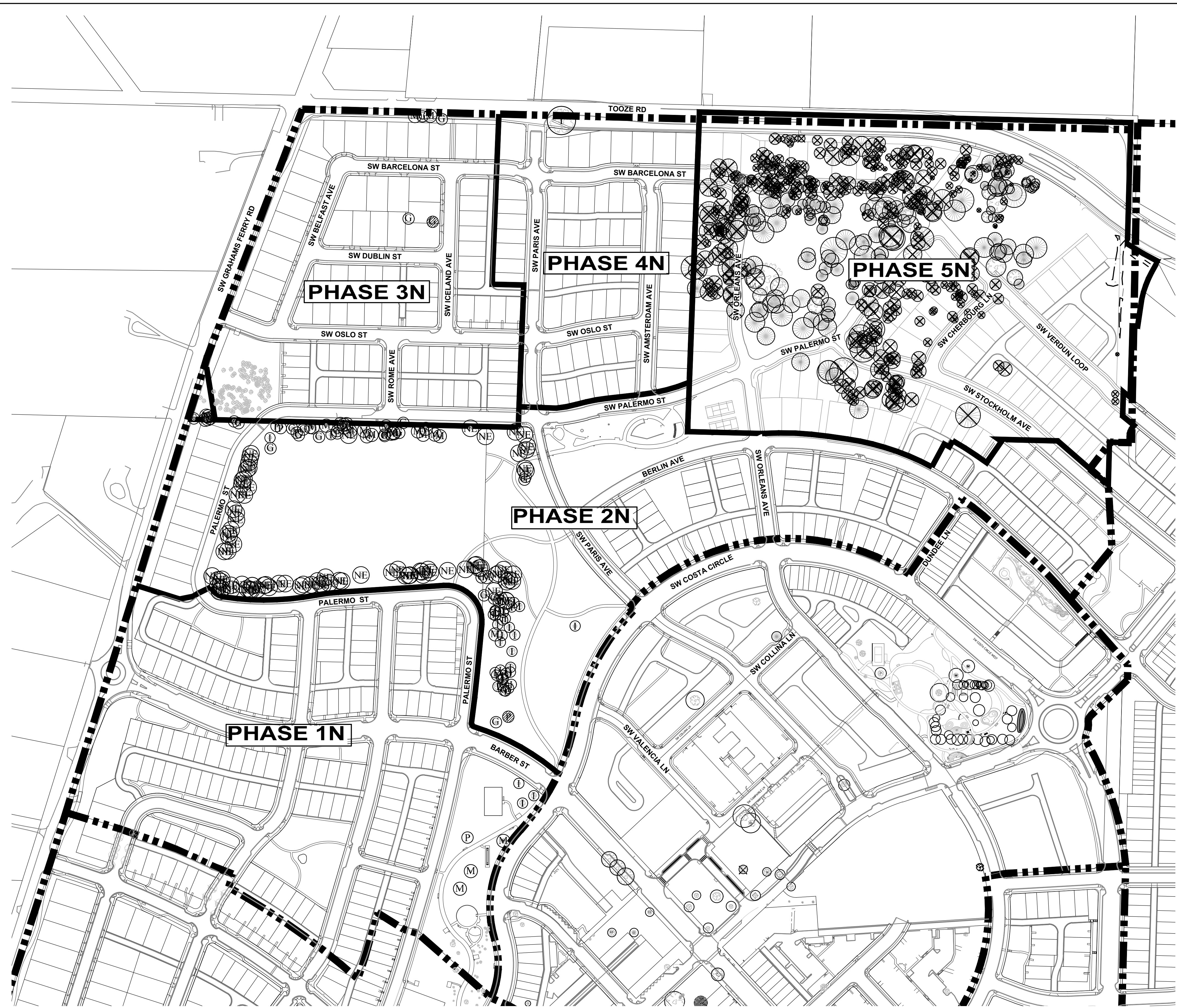

LEGEND:

I	IMPORTANT
G	GOOD
M	MODERATE
P	POOR
NE	NOT EXAMINED
(Circle with dot)	EXISTING TREES TO REMAIN
(Circle with diagonal lines)	EXISTING TREES LIKELY TO BE REMOVED
(Circle with X)	EXISTING TREES TO BE REMOVED

NOTE: SEE SHEET 12.2 FOR MORE DETAILED VIEW OF PDP 5N

ELEVATION DATUM: NAVD 88

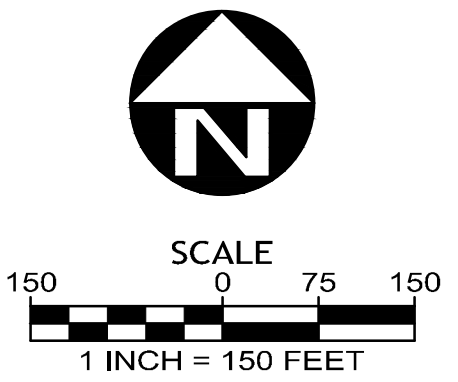

Villebois



POLYGON NW COMPANY



GEODESIGN, INC

SAP NORTH VILLEBOIS

Specific Area Plan

Tree Preservation Plan

PROJECT NUMBER: 395-079
2ND SUBMITTAL DATE: 9/28/2018

12.1



LEGEND:

- I IMPORTANT
- G GOOD
- M MODERATE
- P POOR
- NE NOT EXAMINED
- (Green circle with tree symbol) EXISTING TREES TO REMAIN
- (Orange circle with tree symbol) EXISTING TREES LIKELY TO BE REMOVED
- (Cross-hatched circle with tree symbol) EXISTING TREES TO BE REMOVED

N:\proj\395-079\09 Drawings\03 Planning Sheets - Planning SAP Submittal\395079 (1.2.2)TREPRES S1.dwg - SHEET Layout1 (2) Sep. 28. 18. - 10:42 AM jik

ELEVATION DATUM: NAVD 88



Villebois



POLYGON NW COMPANY



GEODESIGN, INC.

SAP NORTH VILLEBOIS

Specific Area Plan

Tree Preservation Plan (Phase 5N)

PROJECT NUMBER: 395-079
2ND SUBMITTAL DATE: 9/28/2018

12.2

N:\proj\395-079\09 Drawings\03 Planning Sheets - Planning SAP Submittal\395079_13 GRADE.dwg - SHEET: Layout1 Sep. 28. 18 - 10:43 AM jik

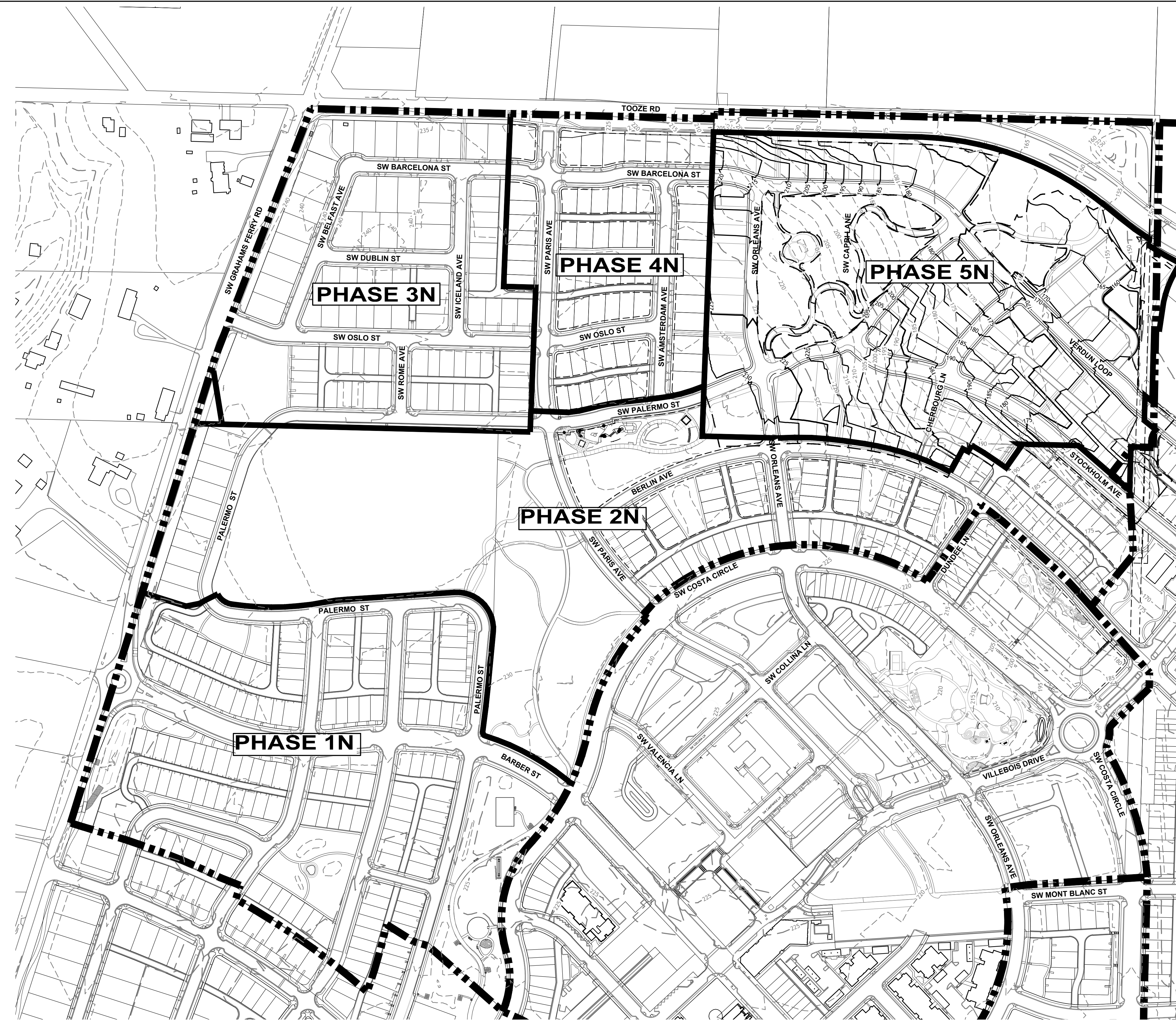

LEGEND:

--- 175 ---	EX 5-FT CONTOUR
--- 200 ---	EX 25-FT CONTOUR
--- 175 ---	PROPOSED 5-FT CONTOUR
--- 200 ---	PROPOSED 25-FT CONTOUR
---	LIMITS OF GRADING
---	SPECIFIC AREA PLAN BOUNDARY

ELEVATION DATUM: NAVD 88

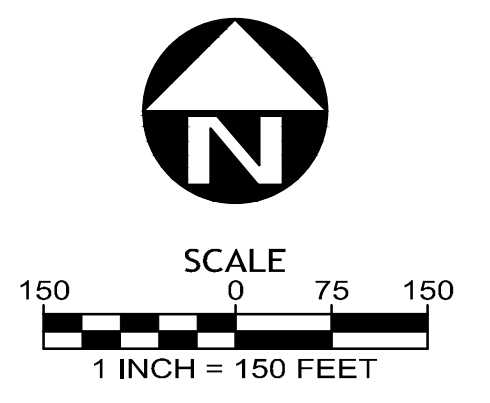

Villebois



POLYGON NW COMPANY



GEODESIGN, INC

SAP NORTH VILLEBOIS

Specific Area Plan

GRADING PLAN

PROJECT NUMBER: 395-079

2ND SUBMITTAL DATE: 9/28/2018

13

N:\proj\395-079\09 Drawings\03 Planning Sheets - Planning SAP Submittal\395079-1\4 UTIL.dwg - SHEET: Layout1 Sep. 28, 18 - 10:45 AM jrk

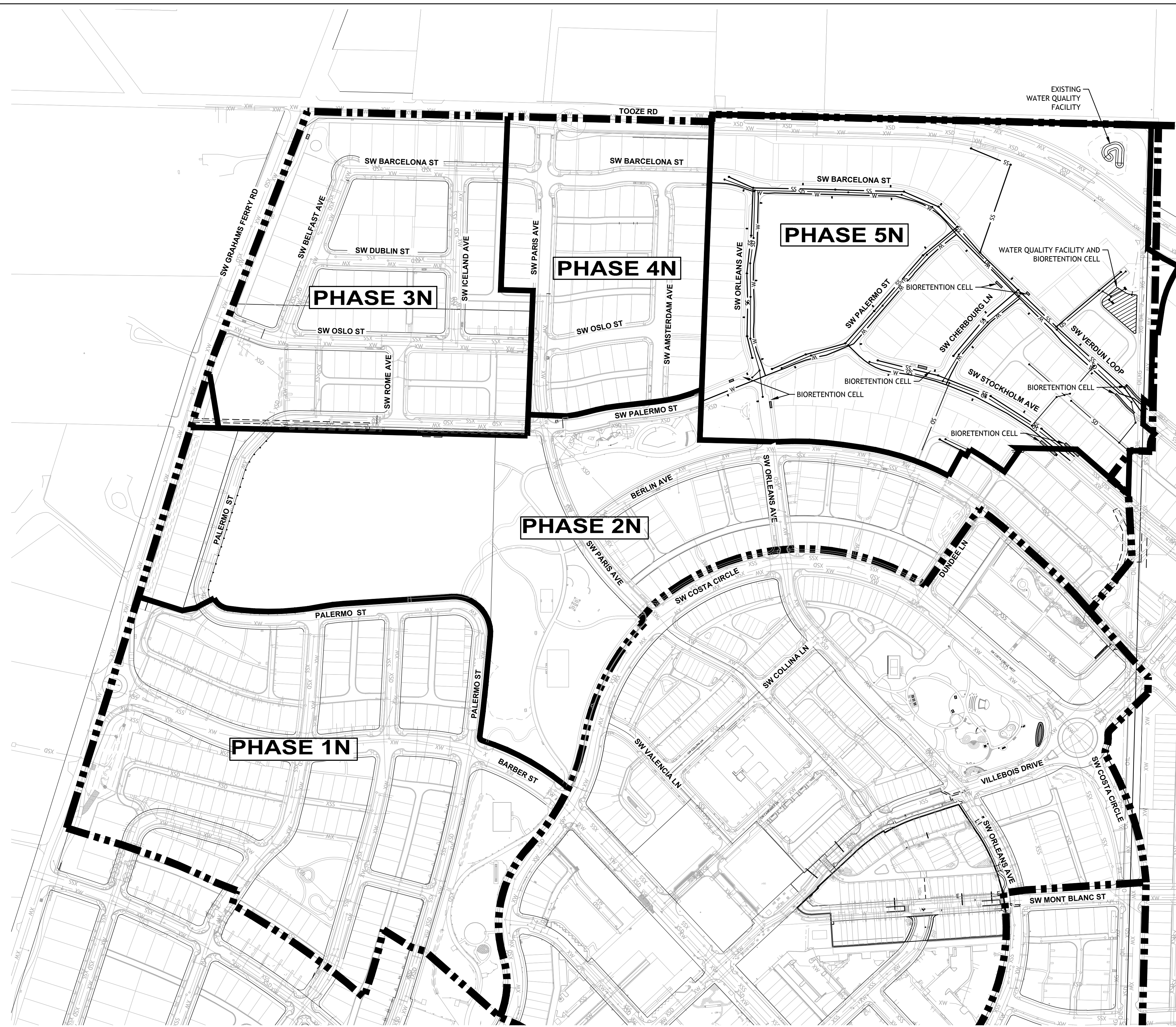

LEGEND:

XSD	EXISTING STORM
XSS	EXISTING SANITARY
XW	EXISTING WATER
SD	PROPOSED STORM
SS	PROPOSED SANITARY GRAVITY MAIN
W	PROPOSED WATER
	BIORETENTION



POLYGON NW COMPANY



GEODESIGN, INC

SAP NORTH VILLEBOIS

Specific Area Plan

UTILITY PLAN

PROJECT NUMBER: 395-079
2ND SUBMITTAL DATE: 9/28/2018

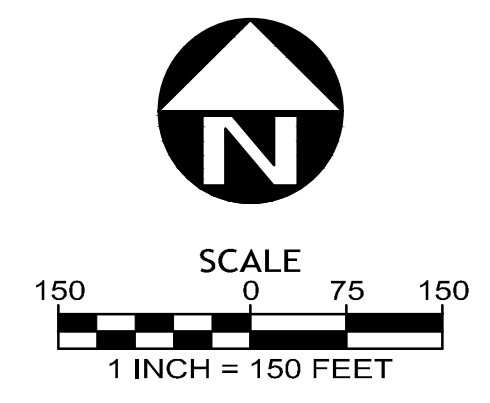

ELEVATION DATUM: NAVD 88